



**[ HVAC-R Market ]**





### **The name to know for controls.**

ICM Controls is a leader in the manufacture of electronic controls for the HVAC/R, Electrical, Pool & Spa, Appliance, RV and Marine Industries. We have achieved this position through product and process innovation, and we strive to maintain this position through extensive capitalization, focusing on our greatest manufacturing strength: true vertical integration.

### **From concept to prototype to production.**

The ICM Controls manufacturing plant, located in North Syracuse, New York, is one of the most vertically integrated facilities in the country. Serving both the OEM and the aftermarket, our goal has been to provide our customers with the most technologically advanced products at the greatest value – without compromise in quality. The ability to quickly take a control from concept to prototype to production has become an ICM Controls trademark.

### **The American made solution.**

We are proud to be American made. ICM Controls personnel are committed to your satisfaction. Please do not hesitate to call us with your questions, comments, or special control application requirements.

**ICM Controls' Sales, Customer Service, and Engineering teams remain at your service.**

**ICM**  
CONTROLS®

# ICM TABLE OF CONTENTS

Air Handling Controller .....	25	Head Pressure Controls .....	39
Bypass Timers .....	12	i3™ Thermostat .....	43
Control Accessories .....	40	ICM Product Index .....	5
Cross Reference Guide .....	8	Industries We Serve.....	4
Custom Logo Form – i3™ Thermostats .....	50	International HVAC Aftermarket & OEM.....	7
Custom Logo Form – SimpleComfort® Thermostats .....	49	Lockout Protection Relays .....	13
Custom Logo Program Instructions .....	48	Motor Protection Controls .....	13
Defrost Controls .....	35	Motor Starters .....	20
Delay on Break Timers .....	12	Oil Burner Primaries .....	35
Delay on Make Timers .....	11	SimpleComfort® Thermostat Accessories .....	46
Dryout / New Construction Thermostats .....	47	SimpleComfort® Thermostat Features .....	44
ECM Controls .....	23	SimpleComfort® Non-Programmable Thermostats .....	44
Fan Blower Controls .....	25	SimpleComfort® PRO Programmable Thermostats .....	45
Fan Coil Relay Control Boards .....	24	Surge Protection Devices .....	18
Frost Sentry™ Garage Thermostats .....	45	Thermostat Quick Reference Guide .....	42
Furnace Controls .....	27	U.S. HVAC Aftermarket Mfr’s Reps .....	6
Gas Ignition Controls .....	32	U.S. OEM – All Industries .....	7
Control Accessories .....	40	UMSR – Universal Motor Starting Relay .....	22

## INDUSTRIES WE SERVE



**Appliance**

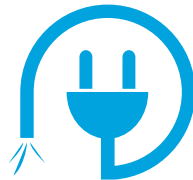

**Electrical**



**HVAC\R**



**Marine**

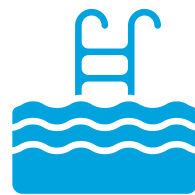

**Pool & Spa**



**RV**

# ICM PRODUCT INDEX

ACC-OE-03.....	40	ICM318 .....	36	ICM856 .....	21
ACC-RT103.....	46	ICM321 .....	36	ICM857 .....	21
ACC-RT104.....	46	ICM324 .....	36	ICM858.....	21
ACC-WP03 .....	46	ICM325HN.....	39	ICM859.....	21
ACC-WP04 .....	46	ICM325HNV.....	39	ICM866U .....	20
ACH045.....	47	ICM326HN .....	39	ICM870 9A.....	20
ACH055.....	47	ICM327HN.....	39	ICM870 16A.....	20
ACH060 .....	47	ICM333 .....	39	ICM1501.....	35
ACH065 .....	47	ICM334 .....	40	ICM1502 .....	35
ACH070 .....	47	ICM379.....	40	ICM1503.....	35
ACH075.....	47	ICM380.....	40	ICM2801 .....	29
ACH085 .....	47	ICM350 .....	36	ICM2804.....	29
ACS-8 .....	14	ICM401 .....	14	ICM2805A.....	30
FS1500L.....	45	ICM402.....	14	ICM2807.....	30
ICM102 .....	11	ICM408.....	14	ICM2808.....	30
ICM102F.....	11	ICM409.....	14	ICM2810 .....	30
ICM103 .....	11	ICM441 .....	15	ICM2811.....	31
ICM104 .....	11	ICM442 .....	15	ICM2812 .....	31
ICM175.....	12	ICM443 .....	15	ICM2812-KIT.....	31
ICM203 .....	12	ICM450A.....	13	ICM2813 .....	31
ICM203F .....	12	ICM450A PLUS+.....	13	ICM2901 .....	32
ICM206.....	12	ICM491 .....	16	ICM2902.....	32
ICM220.....	13	ICM492.....	16	ICM2904.....	33
ICM253 .....	25	ICM493.....	16	ICM2905.....	33
ICM255 .....	26	ICM493-60A.....	16	ICM2906.....	33
ICM256 .....	26	ICM517.....	18	ICM2907.....	33
ICM271.....	26	ICM518 .....	18	ICM2909.....	34
ICM275 .....	27	ICM530 .....	19	ICM2910 .....	34
ICM277 .....	27	ICM531.....	19	ICM2911.....	34
ICM280.....	27	ICM532 .....	19	ICM2918 .....	32
ICM281 .....	27	ICM533 .....	20	ICM3000.....	37
ICM282B.....	28	ICM550 .....	37	ICM6202.....	24
ICM283.....	32	ICM550-ENC .....	37	ICM6500-1 .....	25
ICM287.....	28	ICM708.....	23	ICM6501 .....	25
ICM288.....	28	ICM709 .....	23	i2020WR.....	42
ICM289.....	28	ICM711.....	23	SC1600L .....	44
ICM291 .....	28	ICM712.....	23	SC1600VL .....	44
ICM292 .....	29	ICM713.....	24	SC2010L .....	44
ICM300.....	35	ICM715.....	24	SC5010 .....	45
ICM314 .....	35	ICM716 .....	24	SC5811.....	45
ICM315.....	36	ICM855 .....	21	UMSR-50.....	22



# WORLD WIDE ICM CONTROLS SALES REPS

<b>Courtney Wesneski</b>	<b>National Sales Manager</b>	<b>Electrical – Aftermarket</b>	<b>cwesneski@icmcontrols.com</b>
<b>Keith Clark</b>	<b>National Sales Manager</b>	<b>HVAC-R – Aftermarket</b>	<b>kclark@icmcontrols.com</b>
<b>Roy Cramer</b>	<b>National Sales Manager</b>	<b>HVAC &amp; Appliance - OEM</b>	<b>rcramer@icmcontrols.com</b>
<b>Michael L. St. Joseph</b>	<b>National Sales Manager</b>	<b>Pool &amp; Spa / RV – OEM</b>	<b>mstjoseph@icmcontrols.com</b>

# U.S. HVAC AFTERMARKET MFR'S REPS

COMPANY	REP NAME	PHONE #	FAX #	EMAIL
<b>BUILD PRODUCTS NORTHWEST</b> AK, MT, ID, WA, & OR	<b>Mike McNulty</b>	503-780-3860	N/A	mike@buildproductsnw.com
	<b>Damien Hendricks</b>	971-279-3793	N/A	damien@buildproductsnw.com
	<b>Kevin Scofield</b>	206-475-6066	N/A	kevin@buildproductsnw.com
<b>J. Nicloas &amp; Assoc.</b> FL & Puerto Rico	<b>Jim Nichols</b>	727-423-4944	727-384-4494	jimnich@tampabay.rr.com
	<b>Nick MacFee</b>	727-729-1485	727-384-4494	nickmacfee@brighthouse.com
	<b>Johanne Bueno</b>	786-355-6362	727-384-4494	Johanne_13@hotmail.com
	<b>Whit Parker</b>	321-696-9000	727-384-4494	Whitjna@gmail.com
<b>CENTRAL STATES MARKETING</b> IL South of Hwy 72 and South of Hwy 74 not to include Champaign, to include Springfield, and Decatur, MO, NE, IA, KS, KY the city of Paducah	<b>William R Sheehy</b>	913-220-5548	913-441-5885	bills@csmtkg.co
	<b>Scott Peery</b>	816-602-0585	636-282-2239	scottp@csmtkg.co
	<b>Zachary O'Bryan</b>	314-805-6463	636-282-2239	zacho@csmtkg.co
	<b>Jake Bundy</b>	314-412-8053	N/A	jakeb@csmtkg.co
	<b>Dan Ballieu</b>	314-240-0656	N/A	danballieu@csmtkg.co
<b>DANKO</b> <b>MECHANICAL SALES</b> AZ, CA, CO, HI, NM, NV, City and County of El Paso, TX	<b>Jeanette Sheehy</b>	314-517-3002	636-282-2239	jes@csmtkg.co
	<b>Jeff Hyvarinen</b>	623-202-3573	N/A	jeff@dankomsc.com
	<b>Savannah Calkins</b>	480-338-5494	N/A	savannah@dankomsc.com
	<b>John Van Dyke</b>	602-297-7458	N/A	skeeter@dankomsc.com
	<b>Rudy Sabori</b>	915-490-4827	N/A	rudya@dankomsc.com
	<b>Daniel Sabori</b>	602-469-7774	N/A	daniel@dankomsc.com
	<b>Tom Goebig</b>	602-909-1030	N/A	tom@dankomsc.com
	<b>Daniel Verdick</b>	480-708-1878	N/A	dverdick@dankomsc.com
	<b>Bill Mezin</b>	951-852-3987	N/A	bill@dankomsc.com
	<b>Guy Falkenhagen</b>	310-755-8670	N/A	guy@dankomsc.com
<b>INMAN SALES and MARKETING</b> AL, GA, TN	<b>Noah Hyvarinen</b>	623-826-6066	N/A	noah@dankomsc.com
	<b>Randy Inman</b>	615-394-4192	615-413-5011	randy@inmansalesandmarketing.com
	<b>Jimmy McGee</b>	615-394-1589	615-413-5011	jimmy@inmansalesandmarketing.com
	<b>Joseph Thornton</b>	205-955-4543	615-413-5011	joseph@inmansalesandmarketing.com
<b>MOORE SALES</b> IA, IL, IN, KS, KY, MI, MN, MO, ND, OH, SD, WI, W. PA, WV	<b>Wes Alexander</b>	770-540-0490	615-413-5011	wes@inmansalesandmarketing.com
	<b>Lonnie Moore</b>	812-223-2090	866-902-1216	lonniemoore@mooresalescorp.com
	<b>Matthew Moore</b>	317-985-7649	866-902-1216	mattmoore@mooresalescorp.com
	<b>Phillip Szczepanski</b>	216-672-9327	866-902-1216	philszczepanski@mooresalescorp.com
	<b>Penny Buch</b>	218-214-1317	866-902-1216	pbuch@mooresalescorp.com
	<b>Jerry Herron</b>	614-623-7804	866-902-1216	jerryherron@mooresalescorp.com
	<b>Melissa Szczesny</b>	312-590-3920	888-246-0231	melissaszczesny@mooresalescorp.com
	<b>Alan Griffing</b>	563-275-8256	888-246-0231	alangriffing@mooresalescorp.com
<b>SOUTHWESTERN</b> <b>HVAC SALES</b> AR, OK, LA, MS, TX	<b>Kay Fleetwood</b>	812-882-4037	888-246-0231	kayfleetwood@mooresalescorp.com
	<b>Lois Stephens</b>	812-882-4037	888-246-0231	loisstephens@mooresalescorp.com
	<b>Steve Wood</b>	512-422-6058	512-237-1112	steve@swshvac.com
	<b>Randy Burg</b>	713-306-4897	281-937-7435	randy@swshvac.com
	<b>Warren Finney</b>	817-929-9526	817-537-2505	warren@swshvac.com
	<b>Scott Taylor</b>	501-416-4413	512-237-1112	scott@swshvac.com
	<b>Lonny LeBlanc</b>	337-991-6149	512-237-1112	Lonny@swshvac.com
	<b>Jennifer Bezner</b>	512-237-0251	512-237-1112	jennifer@swshvac.com
	<b>Hayden James</b>	210-427-4533	512-237-1112	hayden@swshvac.com
	<b>Jim Snell</b>	205-789-2528	512-237-1112	jim@swshvac.com
<b>James Banks</b>	N/A	512-237-1112	james@swshvac.com	
<b>Justin Stainback</b>	469-900-7190	512-237-1112	justin@swshvac.com	

ICM CONTROLS CORP. 7313 WILLIAM BARRY BLVD. NORTH SYRACUSE, NY 13212

ISO Certified, OEM & Aftermarket Products • Appliance • Electrical • HVAC-R • Marine • Pool & Spa • RV

# U.S. HVAC AFTERMARKET MFR'S REPS

COMPANY	REP NAME	PHONE #	FAX #	EMAIL
<b>UNITED COMPONENTS</b> CT, DC, MA, MD, ME, NC, NEW ENGLAND, NH, NJ, NY, PA, RI, VA, W.VA, SC, VT	<b>Steve Mironenko Sr.</b>	201-805-0327	201-652-0422	stevesr@ucompinc.com
	<b>Mike James</b>	703-795-0607	888-234-4712	mike@ucompinc.com
	<b>Jeff Hill</b>	540-220-4798	800-385-9791	jeff@ucompinc.com
	<b>Greg Figueredo</b>	908-768-5643	732-750-1939	greg@ucompinc.com
	<b>Bill Mayer</b>	610-517-6267	267-470-4068	bill@ucompinc.com
	<b>Robert Wenzinger</b>	301-672-0228	N/A	robert@ucompinc.com
	<b>Steve Mironenko Jr.</b>	201-394-3089	888-310-9685	stevej@ucompinc.com
	<b>Bruce Waterman</b>	919-946-3684	N/A	bruce@ucompinc.com
	<b>Bob Bradley</b>	336-462-7542	336-786-6543	bob@ucompinc.com
	<b>Dave Walmsley</b>	774-291-0884	N/A	dave@ucompinc.com
	<b>John Mcerlane</b>	214-228-7754	610-446-7414	johnmack@ucompinc.com
	<b>John Bradley</b>	336-399-0757	336-755-3907	john@ucompinc.com
	<b>William Maier</b>	845-558-7696	888-427-8579	william@ucompinc.com
	<b>Matt Hopper</b>	302-547-9274	N/A	mhopper@ucompinc.com
	<b>Taylor Bradley</b>	336-710-1860	336-755-3597	taylor@ucompinc.com
<b>Matt Valint</b>	716-583-6304	N/A	matt@ucompinc.com	
<b>Christine Melnik</b>	201-220-9395	888-612-2700	christine@ucompinc.com	
<b>Alex Mironenko</b>	201-625-2562	N/A	alex@ucompinc.com	
<b>Kemp Phillips</b>	336-775-7056	N/A	N/A	
<b>VISTASALES</b> CO, UT, WY	<b>Katrina Shaffer</b>	303-506-0302	303-781-7368	katrina@vistasales.biz
	<b>Mark Muhonen</b>	303-324-3004	303-989-7912	mark@vistasales.biz
	<b>Scott Muhonen</b>	720-302-3844	303-989-7912	scott@vistasales.biz
	<b>GiAnna Hubler</b>	303-989-7636	303-989-7912	gianna@vistasales.biz

## INTERNATIONAL HVAC AFTERMARKET & OEM

COMPANY	REP NAME	PHONE #	FAX #	EMAIL
<b>ALLTEMP PRODUCTS</b> Canada	<b>Richard Chalmers</b>	905-831-3311	905-831-1864	richard@alltemp.ca
<b>SUN CITY DISTRIBUTORS, INC.</b> Mexico	<b>Letty West</b>	915-727-0601	915-532-2999	wsuncity@aol.com
<b>THERMO CONTROLS</b> Australia	<b>Bryan Livett</b>	0432-111-828	N/A	bryan@thermocontrols.com.au
<b>VSE INTERNATIONAL</b> Middle East, North Africa	<b>Nabeel Hodi</b>	847-590-5785	847-590-5587	vseint@sbcglobal.net

## U.S. OEM – ALL INDUSTRIES

COMPANY	REP NAME	PHONE #	FAX #	EMAIL
<b>BRITT POWER DEVICES</b> AR, LA, OK, TX	<b>Michael Negrón</b>	972-897-5989	972-335-9045	mike@bpdsales.com
	<b>Gary Britt</b>	281-830-4957	615-413-5011	gary@bpdsales.com
	<b>Brett Keller</b>	479-651-6166	615-413-5011	brett@bpdsales.com
	<b>Josh Morris</b>	832-515-7667	N/A	josh@bpdsales.com
<b>CBC COMPONENTS, INC.</b> FL, GA	<b>Seth Brock</b>	813-299-8790	813-926-9369	seth@cbcelectronics.net
	<b>Bill Keikes</b>	407-448-3218	352-735-3095	bill@cbcelectronics.net
	<b>Troy Rodenbo</b>	407-402-5985	352-735-3095	troy@cbcelectronics.net
	<b>Shane Recicar</b>	N/A	N/A	sales@cbcelectronics.net
	<b>JoAnn Keikes</b>	N/A	N/A	joanne@cbcelectronics.net
<b>CONTROLS, COMPONENTS &amp; SYSTEMS</b> IN, MI, KY, OH, TN, WESTERN PA	<b>Rand Smith</b>	419-612-8540	419-892-2074	randsmith@sprintmail.com
	<b>Randy Allen</b>	260-417-2208	260-637-9532	rallen412@comcast.net
	<b>Brian Smith</b>	419-688-9109	N/A	briansmith@sales-ccs.com

PHONE: 1-800-365-5525 FAX: 315-233-5276 WEB: WWW.ICMCONTROLS.COM

All features and specifications are subject to change without notice.



# CROSS REFERENCE GUIDE

REPLACEMENT MODEL	ICM P/N
<b>BYPASS TIMERS</b>	
MARS: 32395	ICM175
SUPCO: TD32	ICM175

<b>DELAY ON MAKE TIMERS</b>	
A-1: 7061	ICM103
A-1: EAC-701-ADJ	ICM102
DIVERSIFIED: ASC-200	ICM150
DIVERSIFIED: AC-800	ICM102
GEMLINE: 1C213	ICM102, ICM103
GEMLINE: 1C310	ICM102
ICE-O-MATIC: TD3001A	ICM103
MARS: 32019, 32391, 32367	ICM102
MARS: 32394, 32396	ICM103
ROBERTSHAW: 3310-068	ICM103
SUPCO: TD69	ICM102
SUPCO: TD69W	ICM102F
SUPCO: TMF-19, TMF-80	ICM103
WAGNER/DIVERSITECH: ADM-1	ICM102
WAGNER/DIVERSITECH: ADM-2	ICM102F

<b>DELAY ON BREAK TIMERS</b>	
A-1: EAC-501-ADJ	ICM203
DIVERSIFIED: AC-100-3	ICM206
DIVERSIFIED: AC-100-5	ICM206
DIVERSIFIED: AC-503	ICM203
MARS: 32001, 32387, 32392	ICM203
MARS: 32382	ICM206
ROBERTSHAW: 3310-072	ICM203
ROBERTSHAW: 3310-183	ICM206
ROBERTSHAW: 3310-305	ICM206
SUPCO: TD72, TD73	ICM203
SUPCO: TD73W	ICM203F
SUPCO: TD74	ICM206
SUPCO: TL243	ICM206
SUPCO: TL245	ICM206
WAGNER/DIVERSITECH: ADB-1	ICM203
WAGNER/DIVERSITECH: ADB-2	ICM203F

<b>DEFROST CONTROLS</b>	
AMANA: C64301-1, C64310-1	ICM300
ARCOAIRE: 32312-00, 3232140	ICM300
ARTESIAN: 10321-00	ICM300
AVION: DFT100	ICM315
CARRIER: CES0110063-00, -01, -02, -02A	ICM321
CARRIER: HK32EA001, EA003, EA008	ICM350
COLEMAN: 3030A374	ICM300
ESSEX: 621-1 TO 621-10, 621-110, 621-111, 621-310	ICM300
GOODMAN: B12260-06	ICM300
GOODMAN: B1226008, PCBDM101(S)	ICM318
GOODMAN: PCBDM133, PCBDM133	ICM314
HEIL QUAKER: HQ1052757	ICM300
HONEYWELL: ST74A1004/20/38	ICM300
ICM: W1001-4	ICM318
ICP: 1052757	ICM300
ICP: 1171803	ICM321

REPLACEMENT MODEL	ICM P/N
<b>DEFROST CONTROLS (continued)</b>	
ICP: 1173425	ICM321
ICP: 1173636	ICM350
INTERMATIC/GRASSLIN: 010-0011B, DT040, DT140, DTAV40, DTAV40M, DT-B, DTMV, DTSX	ICM550, ICM550-ENC
INTERTHERM: 6208800	ICM300
INTERTHERM: 6208800	ICM300
LENNOX: 33G9501	ICM300
LENNOX: 33G9501	ICM300
MARS: 32572	ICM300
PARAGON: 8041, 8045, 8047, 8141, 8143, 8145, 8245, 8247	ICM550, ICM550-ENC
PRECISION: 6041, 6045, 6047, 6141, 6145	ICM550, ICM550-ENC
RANCO: E-15	ICM315
RHEEM: 47-21776-01	ICM300
ROBERTSHAW/UNI-LINE: TD-10, DT2-1000	ICM300
SNYDER GENERAL: 1395-329	ICM300
STEVECO: 90-621	ICM300
THERM-O-DISC: 26E-10	ICM300
WEATHERKING (ADDISON): 840-4-5548	ICM300
WHITE-RODGERS: 90-621	ICM300

<b>DEMAND DEFROST CONTROLS</b>	
RHEEM: 1157-100, 1157-110, 1157-120, 1157-121, 47-102684-01, 47-102684-02, 47-102684-03, 47-102684-04, 47-102684-08, 47-102685-02, 47-102685-04, 47-102685-05, 47-102685-06, 47-102685-07, 47-21517-22, DDL-122131-2RH	ICM3000
WHITE RODGERS: 47D43-101-90, 47D43-111-01, 47D43-111-02, 47D43-111-03, 47D43-111-04, 47D43-811	ICM3000

<b>ECM CONTROLS</b>	
EVO/ECM: VCU-36-MP	ICM708
EVO™/ECM: 4SPD	ICM709
EVO™/ECM: ACU+-S1	ICM711
IEC: E025-71521506	ICM712
HOFFMAN: 880-ECM(10)SSHP	ICM713
QWIK PRODUCTS: QWIKSWAPX1	ICM715
QWIK PRODUCTS: QWIKSWAPX3	ICM716

<b>FAN BLOWER CONTROLS</b>	
A-1: 5893	ICM255
BARD: 8201-056	ICM255
CARRIER: 302075-3, CES0110017, CES0110018	ICM271
CARRIER: CES0110019	ICM275
CARRIER: HH84AA001/003/005/009/014/ 015/021	ICM275
CARRIER: HH84AA010/011/012/013/020, P771-7002	ICM271
GOODMAN: B1370735S, PCBFM131S	ICM277
GOODMAN: PCBFM103, PCBFM103S	ICM256
MARS: 32574	ICM255
RHEEM: 42-22515-01/02/03	ICM255
ROBERTSHAW: 695-100	ICM271
ROBERTSHAW: 695-101	ICM275
SNYDER GENERAL/ICP: 1395336	ICM255

<b>FAN COIL RELAY CONTROL BOARDS</b>	
N/A	ICM6202



REPLACEMENT MODEL	ICM P/N
<b>FURNACE CONTROL BOARDS</b>	
<b>CARRIER:</b> 325878-751	ICM282B
<b>CARRIER:</b> CES0110057-00/01/02	ICM281
<b>CARRIER:</b> CES0110020, CES0110048	ICM281
<b>CARRIER:</b> CES0110074-01	ICM2804
<b>CARRIER:</b> HK42FZ017	ICM2807
<b>CARRIER:</b> HK42FZ-004/007/008/009/ 011/ 013/ 016/34	ICM282B
<b>CARRIER:</b> HH84AA016	ICM281
<b>CARRIER:</b> LH33WP003/3A	ICM291
<b>GOODMAN:</b> B18099-04	ICM287
<b>GOODMAN:</b> PCBFF110/S, PCBFF123/S, 0130F00005/S, PCBFF112/S, B18099-26/S	ICM2811
<b>GOODMAN:</b> PCBFF136, PCBFF140	ICM2810
<b>GOODMAN:</b> B18099-06/08/10/13/13S	ICM280
<b>ICP:</b> 1171166	ICM291
<b>ICP:</b> 1176943	ICM282B
<b>LENNOX:</b> ALL BCC1, BCC2, BCC3 circuit boards, including 48K98	ICM289
<b>LENNOX:</b> 10M9301, 12L6901, 32M8801, 56L8401, 24L8501, 63K8901, 97L4801, 100925-01, 100925-03, 17W9201, 23W5101, 30W2501, 69M0801, 69M1501, 83M00	ICM2813
<b>NORDYNE:</b> 624631	ICM2805A
<b>RHEEM:</b> 62-24140-04	ICM292
<b>RHEEM:</b> 62-24084-82	ICM288
<b>TEXAS INSTRUMENTS:</b> 41F-5	ICM280
<b>UTEC:</b> 1012-933D	ICM280
<b>WHITE-RODGERS:</b> 50A55-743, 50A55-289, 50T55-289	ICM2811
<b>WHITE-RODGERS:</b> 50A65-120, 50A65-121, 50A62-120, 50A62-121, 50A62-820, 21D83M-843, 50A66-122, 50A66-123	ICM2813
<b>WHITE-RODGERS:</b> 50M56U-843	ICM2812, ICM2812-KIT
<b>WHITE-RODGERS:</b> 50T35-730, 50T35-743	ICM280
<b>YORK:</b> S1-331-03010000, S1-331-02956000	ICM2808
<b>YORK:</b> 7990-319P	ICM2801

<b>GAS IGNITION CONTROLS</b>	
<b>FENWAL:</b> 35-725200-005	ICM2910-200-005
<b>FENWAL:</b> 35-725201-007	ICM2910-201-007
<b>FENWAL:</b> 35-725201-501	ICM2910-201-501
<b>FENWAL:</b> 35-725201-505	ICM2910-201-505
<b>FENWAL:</b> 35-725205-015	ICM2910-205-015
<b>FENWAL:</b> 35-725205-017	ICM2910-205-017
<b>FENWAL:</b> 35-725205-021	ICM2910-205-021
<b>FENWAL:</b> 35-725205-115	ICM2910-205-115
<b>FENWAL:</b> 35-725205-521	ICM2910-205-521
<b>FENWAL:</b> 35-725206-515	ICM2910-206-515
<b>FENWAL:</b> 35-725405-013	ICM2910-405-013* Open Board Design
<b>HONEYWELL:</b> S8610U (and compatible Camstat, Fenwal, HSC, Penn-Johnson, Robertshaw and White Rodgers models)	ICM290A
<b>HONEYWELL:</b> S8910U-1000	ICM283
<b>JOHNSON CONTROLS:</b> G770RJA-1	ICM2901
<b>LENNOX:</b> G776 (63K2401, 41K8701, 69J3601)	ICM2902
<b>MODINE SPARK IGNITION CONTROL:</b> 5H79749	ICM2911
<b>REZNOR:</b> 257009	ICM2904
<b>REZNOR:</b> 257010	ICM2905
<b>REZNOR:</b> 195573	ICM2906
<b>REZNOR:</b> 195265	ICM2907
<b>RHEEM:</b> 62-23599(-01,-02,-03,-04,-05)	ICM2909
<b>ROBERTSHAW:</b> H5780	ICM283

REPLACEMENT MODEL	ICM P/N
<b>GAS IGNITION CONTROLS (continued)</b>	
<b>UNITED TCH:</b> 1003-638A	ICM2904
<b>UNITED TCH:</b> 1003-514	ICM2905
<b>UNITED TCH:</b> 1097-211	ICM2906
<b>UNITED TCH:</b> 1097-210	ICM2907
<b>WHITE RODGERS:</b> 50E47, 50F47	ICM283

<b>HEAD PRESSURE CONTROLS</b>	
<b>ACT:</b> FM2000	ICM325HN
<b>ACT:</b> FM4000	ICM326HN
<b>ACT:</b> FM4000	ICM327HN
<b>HOFFMAN:</b> 800, 800A, 800AA, 814-50, 816-10	ICM325HN, 326HN, 327HN
<b>JOHNSON CONTROLS:</b> P66BAB/BAD	ICM333 (for 2 temp or 2 pres inputs)
<b>MITSUBISHI:</b> MU09NW, MUH09NW, MU12NN, MU15NN, MU17NN, MUM18NW, MUM30NN, MUM30NN2	ICM326HM2
<b>RANCO:</b> E31	ICM325HN, ICM326HN, ICM327HN
Optional Pressure Transducer	ICM380
N/A	ICM334

<b>LINE MONITORS</b>	
<b>A-1:</b> EAC-401, 402, 403, 404	ICM491, ICM492, ICM493
<b>A-1:</b> EAC-800, EAC-8000, EAC-8002	ICM450A, ICM450A PLUS+
<b>BRISTOL:</b> 241680	ICM441
<b>COPELAND:</b> 071-0376-01 & -02, 071-0397-00 & -01, 071-0424-00 & -01, 071-9800-01 & -02	ICM441
<b>COPELAND:</b> 085-0160-00	ICM450A, ICM450A PLUS+
<b>DIVERSIFIED:</b> AC-2020, AC-301, AC-302	ICM450A, ICM450A PLUS+
<b>DIVERSIFIED:</b> CV-100-RS, CV-200-RS15 CV-200-RS20	ICM491
Function of ICM400, DIN rail mount	ICM409
<b>MARS:</b> 32536	ICM401, ICM402
<b>MARS:</b> 32532, 32534, 32540, 32541, 32542	ICM408
Function of ICM400, plug-in panel mount	ICM408
<b>MARS:</b> PFM-2000	ICM450
<b>MOTORSAVER:</b> 455	ICM450A, ICM450A PLUS+
<b>SSAC:</b> QLM, QLV	ICM450A, ICM450A PLUS+
<b>SUPCO:</b> TPMP2	ICM401, ICM402,
<b>TIME MARK:</b> 265	ICM450A, ICM450A PLUS+
<b>WAGNER/DIVERSITECH:</b> DSP-1	ICM491, ICM492
<b>WAGNER/DIVERSITECH:</b> DSP-1	ICM493
<b>WAGNER/DIVERSITECH:</b> DTP-3, WPC-800	ICM450A, ICM450A PLUS+

<b>LOCKOUT PROTECTION RELAYS</b>	
<b>ESSEX:</b> Independent Relays Series 84 and 93	ICM220

<b>MOTOR PROTECTION</b>	
<b>MARS:</b> 37300, 37302, 37304, 37306, 37322	ICM441
N/A	ICM442
<b>TEXAS INSTRUMENTS:</b> 15AA1600B, 15AA1600C, 15AA1603B, 15AA1603C, 31AA1600E, 31AA1606E	ICM441

<b>MOTOR STARTERS/RAPID START</b>	
<b>5-2-1:</b> CSR-U1	ICM866U
<b>5-2-1:</b> CSR-U2/U3	ICM866U
<b>A-1:</b> WSX-5	ICM855
<b>A-1:</b> WSX-6	ICM856
<b>KICKSTART:</b> KS1	ICM866U
<b>KICKSTART:</b> T05, KS8	ICM866U
<b>MARS:</b> 32701, 35701	ICM855



REPLACEMENT MODEL	ICM P/N
<b>MOTOR STARTERS/RAPID START (continued)</b>	
MARS: 32702, 35702	ICM856
MARS: 32781	ICM857
SUPCO: SPP-5	ICM855
SUPCO: SPP-5E	ICM866U
SUPCO: SPP-6	ICM856
SUPCO: SPP-6E	ICM866U
SUPCO: SPP-8, SPP-8E	ICM866U
SUPCO: RCO210	ICM859
SUPCO: RCO410	ICM858
SUPCO: RCO810	ICM857
WAGNER/DIVERSITECH: DST-5	ICM855
WAGNER/DIVERSITECH: DST-6	ICM856

<b>MULTI-FUNCTIONAL TIMERS</b>	
INTERMATIC/GRASSLIN: 010-0011B, DT040, DT140, DTAV40, DTAV40M, DT-B, DTMV, DTSX	ICM550, ICM550-ENC
PARAGON: 8041, 8045, 8047, 8141, 8143, 8145, 8245, 8247	ICM550, ICM550-ENC
PRECISION: 6041, 6045, 6047, 6141, 6145	ICM550, ICM550-ENC

<b>OIL BURNER PRIMARY CONTROL</b>	
CARLIN: 48245	ICM1503
HONEYWELL: R8184G: 4009, 1138, 1427, 4025	ICM1503
HONEYWELL: R8184G: 4066, 1161, 1294	ICM1501
HONEYWELL: R8184G: 4074, 1179, 1302, 4033	ICM1502
WHITE-RODGERS: 668-401	ICM1503

<b>SINGLE PHASE SURGE PROTECTION</b>	
INTERMATIC: AG3000	ICM517
SUPCO: SCMPLUS, SCM150	ICM517

<b>SOFT START</b>	
DOMETIC SMART START: 340582	ICM870-16A
DOMETIC SMART START: 340583	ICM870-9A

<b>SPLIT PHASE SURGE PROTECTIVE DEVICE</b>	
ASCO: 420120S	ICM518
EATON: SP1-240S, SP2-240S	ICM518
ERICO (CRITEC): TDX50C240	ICM518
GENERAC: G0073000	ICM518
INTERMATIC: AG2401C3, IG1200RC3, IG1240RC3, IG3240RC3	ICM518
LEVITON: 55240-ASA	ICM518
MARS: 83905	ICM518
ROBERTSHAW: 300-229, 9615	ICM518
ROBERTSHAW: 8625-1	ICM518
SIEMONS: TPS3A	ICM518

<b>SURGE PROTECTIVE DEVICE</b>	
ABB: OVRHLDXX-120	ICM530
ABB: OVRHLDXX-277	ICM531
ASCO: 420120Y, 420240D	ICM530
ASCO: 420240H	ICM533
ASCO: 420277Y, 420480D	ICM531
ASCO: 420347Y, 420600D	ICM532
EATON: SP1-208Y, SP1-240D, SP2-208Y, SP2-240D	ICM530
EATON: SP1-480Y, SP1-480D, SP2-480Y, SP2-480D	ICM531
EATON: SP1-600Y, SP1-600D, AP2-600Y	ICM532
EATON: SPD050240H1	ICM533

REPLACEMENT MODEL	ICM P/N
<b>SURGE PROTECTIVE DEVICE (continued)</b>	
ERICO (CRITEC): TDX50C277/480	ICM531
ERICO (CRITEC): TXD50C120/208, TXD50C120/240D	ICM530
ERICO (CRITEC): TXD50C347/600	ICM532
INTERMATIC: AG2083C3 L5F13Y1DG1	ICM530
INTERMATIC: AG2403C3, L5F13D1DG1	ICM533
INTERMATIC: AG4803C3, L5F13Y2DG1	ICM531
INTERMATIC: AG6503, L5F13Y3DG1	ICM532
LEVITON: 55208-ASA	ICM530
LEVITON: 55480-ASA	ICM531
SIEMENS: TPS3B	ICM533
SIEMENS: TPS3D, TPS3C	ICM530
SIEMENS: TPS3E, TPS3F	ICM531
SIEMENS: TPS3L, TPS3G	ICM532
SQUARE D: SDSA2040, SDSA2040D	ICM530
SQUARE D: SDSA2040D	ICM533
SQUARE D: SDSA3650, SDSA3650D	ICM532
SQUARE D: SDSA4040, SDSA4040D	ICM531

<b>THERMOSTATS (7-DAY PROGRAMMABLE)</b>	
HONEYWELL: TH6110D1005, TH6110D1021	SC5010
HONEYWELL: TH6220D1002, TH6220D1028	SC5811 (hardwired only)
HONEYWELL: T8600D2028, TH4110D1007, TH2110D1099	SC5010
ROBERTSHAW: 300-229, 9615	SC5811
ROBERTSHAW: 8625-1	SC5811
ROBERTSHAW: RS5110, RS6110	SC5010
WHITE-RODGERS: 1F80-0471, 1F80-0671, 1F97-1277	SC5010
WHITE-RODGERS: 1F81-261, 1F85-0422	SC5811

<b>THERMOSTATS (NON-PROGRAMMABLE)</b>	
HONEYWELL: T8400, T8401 Series	SC2010L
HONEYWELL: T8775A1009, TH1100D1001	SC1600L/SC1600VL
HONEYWELL: TH110D1000, TH3110D1008	SC2010L
ROBERTSHAW: 300-206	SC2010L
ROBERTSHAW: 300-204	SC1600L/SC1600VL
ROBERTSHAW: 8400-1, 9400, 9500, RS2110	SC2010L
WHITE-RODGERS: 1F86-344, 1F86-0244	SC2010L
WHITE-RODGERS: Mechanical 1F30-321, 1C20-102	SC1600L/SC1600VL

<b>THERMOSTATS (TEMPORARY)</b>	
JACKSON SYSTEMS: CL-45, CL-55, CL-75 (COOL)	ACHO: 45, 55, 75
JACKSON SYSTEMS: TS-60, TS-65 & TS-70 (HEAT)	ACHO: 60, 65, 70

<b>UNIVERSAL INTERMITTENT PILOT IGNITION CONTROL</b>	
ICM290A, Honeywell S8610U & over 280 other models	ICM2918

<b>UNIVERSAL MOTOR STARTING RELAYS</b>	
SUPCO: SUPR, APR5	UMSR50

# DELAY ON MAKE TIMERS

## Applications

Ideal for compressor staging and stagger starting multiple motors and other equipment. Helps to reduce power surges.

**Primary Function:** *Ideal for compressor staging*

## Mode of Operation

When power is applied to the input, the time delay begins. After the time delay is complete, the load energizes.



## ICM102, ICM102F

### FEATURES/APPLICATION

- Universal voltage operation
- Higher 1.5 amp power rating
- Knob-adjustable time delays
- Works with anticipator-type thermostats
- One model replaces many in field
- Ideal for compressor staging
- Simple 2-wire hookup
- "F" suffix denotes 6" wire leads

### SPECIFICATIONS

- **Voltage:** 18-240 VAC
  - 1.5 amps
  - 15 amp inrush
  - 40 mA holding current
- **Frequency:** 50/60 Hz
- **Adjustable delay:** .03-10 min (1.8-600 secs)
- **Voltage drop:** 2.5 V @ 1.5 amps
- **Dimensions:** 2.00" x 2.00" x 1.25"

### REPLACES

- ICM102**
- **A-1:** EAC-701-ADJ
  - **Diversified:** AC-800
  - **Gemline:** 1C310, 1C213
  - **Mars:** 32019, 32391, 32367
  - **Supco:** TD69
  - **Wagner/DiversiTech:** ADM-1
- ICM102F**
- **Supco:** TD69W
  - **Wagner/DiversiTech:** ADM-2

## ICM103

### FEATURES/APPLICATION

- Highly precise digital timing
- Switch-settable time delays
- Ideal for ice machine applications
- Universal voltage operation
- Repeat accuracy .5% over voltage and temperature range

### SPECIFICATIONS

- **Voltage:** 18-240 VAC
  - 1 amp
  - 10 amp inrush
  - 40 mA holding current
- **Frequency:** 50/60 Hz
- **Switch-settable delays:** Range from 1-1,023 sec.
- **Voltage drop:** 2.5 V @ 1 amp
- **Dimensions:** 2.00" x 2.00" x 1.25"

### REPLACES

- **A-1:** 7061
- **Gemline:** 1C213
- **Ice-O-Matic:** TD3001A
- **Mars:** 32394, 32396
- **Robertshaw:** 3310-068
- **Supco:** TMF-19, TMF-80



## ICM104

### FEATURES/APPLICATION

- Highly precise digital circuitry
- High power, SPDT relay output
- Input to output isolation
- Works with anticipator-type thermostats
- Repeat accuracy .5% over voltage and temperature range
- Rugged, compact package

### SPECIFICATIONS

- **Voltage:** 18-30 VAC
- **Frequency:** 50/60 Hz
- **Output:**
  - **N.O.:** 20 amps @ 240 VAC
  - **N.C.:** 10 amps @ 240 VAC
- **Form:** SPDT, 1 form C
- **Knob-adj. time delay:** 10-1,000 sec.
- **Dimensions:** 3.00" x 2.00" x 1.25"

### REPLACES

- **Mars:** 32394/32398

## DELAY ON BREAK TIMERS

### Applications

Helps to protect your equipment from damage which may be caused by the rapid short cycling of compressors.

### Primary Function: *Anti-short cycle protection*



### ICM203, ICM203F

#### FEATURES/APPLICATION

- Universal voltage operation
- Higher 1.5 amp power rating
- Compressor lockout/anti-short cycle timer
- Helps to protect compressors from damage caused by rapid short cycling
- Simple, 2-wire hookup
- "F" suffix denotes 6" wire leads

### Mode of Operation

Upon application of power, the load is energized. When the thermostat or other switch opens or there is a loss of power, the load is de-energized and the delay period begins. The compressor will not start again during the delay period. Restart occurs after the delay period has elapsed.

#### SPECIFICATIONS

- **Voltage:** 18-240 VAC
  - 1.5 amps, 15 amp inrush
- **Frequency:** 50/60 Hz
- **Knob-adjustable delays:** .03-10 min. (1.8-600 sec.)
- **Voltage drop:** 3.5 V typical, 4.5 V max. @ 1.5 amps
- **Holding current min.:** 40 mA
- **Dimensions:** 2.00" x 2.00" x 1.25"

#### REPLACES

- ICM203**
- **A-1:** EAC-501-ADJ
  - **Diversified:** AC-503
  - **Mars:** 32001, 32387, 32392
  - **Robertshaw:** 3310-072
  - **Supco:** TD72, TD73
  - **Wagner/DiversiTech:** ADB-1
- ICM203F**
- **Supco:** TD73W
  - **Wagner/DiversiTech:** ADB-2

### ICM206

#### FEATURES/APPLICATION

- Brownout protection
- UL 873 recognition as compressor controller
- Helps prevent scroll compressor reversal
- Fast response time: 16 ms
- Compressor lockout/anti-short cycle timer
- Eliminates relay chatter due to thermostat bounce or tampering
- Works with anticipator-type thermostats

#### SPECIFICATIONS

- **Voltage:** 18-30 VAC
  - 1.5 amps, 15 amp inrush
- **Frequency:** 50/60 Hz
- **Time delays:** 3 to 10-minute adjustable time delay
- **Holding current min.:** 40 mA
- **Dimensions:** 2.00" x 2.00" x 1.25"

#### REPLACES

- **A-1:** EAC-426-ADJ
- **Supco:** TD74



## BYPASS TIMERS

### Applications

Designed to bypass a control or device during startup. Typically used to bypass a low pressure switch during compressor heat pump startup or to bypass an oil pressure switch upon startup. Helps to eliminate nuisance lockouts.

### Primary Function: *To bypass a switch or device during startup*

### Mode of Operation

With power applied to the input, the load energizes immediately and remains energized for the length of the time delay, regardless of the state of the switch being bypassed. At the end of the time delay, the condition of the load is determined by the state of the switch.



### ICM175

#### FEATURES/APPLICATION

- Designed to bypass a low pressure switch or other device during startup
- Ideal for low ambient startups
- Key component for "winter start" kits
- Helps to reduce nuisance lockouts
- Universal AC voltage operation
- Knob-adjustable time delay
- Epoxy-encapsulated circuitry

#### SPECIFICATIONS

- **Voltage:** 18-240 VAC
  - 1 amp
  - 10 amp inrush
  - 40 mA holding current
- **Frequency:** 50/60 Hz
- **Knob adjustable time delay:** 10-1,000 sec.
- **Dimensions:** 2.00" x 2.00" x 1.25"

#### REPLACES

- **Mars:** 32395
- **Supco:** TD32

# LOCKOUT PROTECTION RELAYS

## Application

Monitors various switch inputs to help protect your compressor.

## Mode of Operation

Upon application of power with the safety switches closed, the load will energize. If any of the safety switches open for longer than 600 ms, the fault light will come on and the load will stay de-energized regardless of the state of the safety switches. Power must then be removed for 100 ms and safety switches must be closed in order to re-energize the load, upon which the fault light will be off.

## Primary Function: Lockout protection



## ICM220

### FEATURES/APPLICATION

- UL 873 recognition as compressor controller
- Low cost lockout relay
- Helps eliminate nuisance lockouts typical of Series 84 and 93 impedance relays
- Ideal for use with safety/interlock switches
- Replaces impedance relays Series 84 and 93

### SPECIFICATIONS

- **Voltage:** 18-30 VAC
- **Frequency:** 50/60 Hz
- **Power consumption:** 2 watts maximum @ lockout
- **Relay:** 1 form C
- **Contacts:** 2 amps @ 30 VAC resistive
- **Dimensions:** 2.00" x 2.00" x 1.25"

### REPLACES

- **Essex:** Impedance Relays Series 84 and 93

# MOTOR PROTECTION CONTROLS

## 3-PHASE LINE VOLTAGE MONITORS • FULL PERFORMANCE

ICM's full performance line voltage monitors offer complete system protection by monitoring both the line (front) and load (back) side of the system including the power, motor and contactor lines. In addition, an integral "delay on break timer" guards against rapid short cycling at both the control circuit and the 3-phase lines. Provides highly reliable protection for your valuable equipment.

FEATURES	ICM450A	ICM450A PLUS+
✓ Backlit LCD	•	•
✓ Simultaneous 3-phase true RMS voltage monitoring	•	•
✓ Factory calibrated	•	•
✓ 3-phase voltages simultaneously displayed on LCD	•	•
✓ Fault memory	•	•
✓ Fault monitoring: High / low voltage, voltage unbalance, phase loss, phase reversal	•	•
✓ Real time clock, date and time stamped events		•
✓ Simple configuration	•	•
✓ Fully adjustable variables	•	•
✓ Modbus RS485 communication port		•
✓ LED indicators	•	•
✓ Common 1/4" quick connect terminations	•	•
✓ English or Spanish menu options	•	•



## SPECIFICATIONS

### INPUT

- **Line voltage:** Universal, 190-600 VAC
- **Frequency:** 50-60 Hz
- **Load side monitoring:** Optional
- **Voltage:** 18-240 VAC

### OUTPUT:

- **Type:** Relay, SPDT
- **Voltage:** 277 VAC @ 6A maximum

### CONTROL OPERATING TEMPERATURE

- **Operating temperature:** -40°F to +149°F (-40°C to +65°C)
- **Storage temperature:** -40°F to +185°F (-40°C to +85°C)

### MECHANICAL

- **Mounting:** Surface mount using (2) #8 screws
- **Terminations:** 1/4" quick connects
- **Weight:** 12 ounces (341 grams)
- **ModBus:** RS485 Communication (ICM450A plus+)
- **Dimensions:** 6.50" x 4.75" x 1.09"

### ORDERING INFORMATION

- **ICM450A:** Supersedes ICM450
- **ICM450A PLUS+:** Supersedes ICM450, ICM455

## REPLACES

- **A-1:** EAC-800, EAC-8000, EAC-8002
- **Copeland:** 085-0160-00
- **Diversified:** AC-2020, AC-301, AC-302
- **Mars:** PFM-2000
- **Motorsaver:** 455
- **SSAC:** QLM, QLV
- **Time Mark:** 265
- **Wagner/DiversiTech:** DTP-3, WPC-800



# PHASE LOSS AND REVERSAL PROTECTION • ULTRA LOW COST



## ICM401

### FEATURES/APPLICATION

- Low cost 3-phase protection for single side
- Monitors for phase reversal, phase loss, unbalance % as a function of Input voltage
- Bright LED indicators for ON and FAULT
- Universal 3-phase input: 190-600 VAC
- Epoxy coated for added protection
- Patented: U.S. Patent No. 5,337,206

### SPECIFICATIONS

- **Voltage:** 190-600 VAC
- **Frequency:** 50/60 Hz
- **Control:** 18-30 VAC
- **Output:**
  - **Relay:** SPST
  - **N.O.:** 10 amps
- **Dimensions:** 3.00" x 3.20" x 1.35"

### REPLACES

- **Supco:** TPMP2
- **Mars:** 32536

## ICM402

### FEATURES/APPLICATION

- Low cost 3-phase protection for single side
- Monitors for phase reversal, phase loss, unbalance % as a function of Input voltage
- Bright LED indicators for ON and FAULT
- Universal 3-phase input: 190-600 VAC
- Highly reliable passive electronics
- Epoxy coated for added protection
- Patented: U.S. Patent No. 5,337,206

### SPECIFICATIONS

- **Voltage:** 190-600 VAC
- **Frequency:** 50/60 Hz
- **Control:** 115 or 208/230 VAC
- **Output:**
  - **Relay:** SPST
  - **N.O.:** 30 amps
- **Dimensions:** 3.00" x 3.20" x 1.35"

### REPLACES

- **Supco:** TPMP2
- **Mars:** 32536



## ICM408

### FEATURES/APPLICATION

- Reliable 3-phase protection for single side
- Monitors for phase reversal, phase loss, unbalance % and high/low voltage
- Bright LED indicators for ON and FAULT
- High/low voltage cut out:
  - High voltage cut out set point: +12%
  - Low voltage cut out set point: -12%
- Heavy duty SPDT
- Phase reversal detection: detects on power up
- 8-pin plug-in mount (base sold separately – Order: ACS-8)

### SPECIFICATIONS

- **Voltage:** 190-480 VAC
- **Frequency:** 50/60 Hz
- **Adjustable DOB:** .1-5 min.
- **Adjustable DOM:** .1-5 min.
- **N.O./N.C. contacts:** 10 amps resistive @ 250 VAC
- **Power/phase loss detection:** within 100 ms
- **User selectable unbalance voltage:** 2 to 8%
- **User selectable delay on make:** .1 to 5 minutes
- **Dimensions:** 2.89" x 2.40" x 1.79"

### REPLACES

- **Mars:** 32532, 32534, 32540, 32541, 32542

## ICM409

### FEATURES/APPLICATION

- Reliable 3-phase protection for single side
- Monitors for phase reversal, phase loss, unbalance % and high/low voltage
- Bright LED indicators for ON and FAULT
- High/low voltage cut out:
  - High voltage cut out set point: +12%
  - Low voltage cut out set point: -12%
- Heavy duty SPDT
- Phase reversal detection: detects on power up
- DIN rail mount

### SPECIFICATIONS

- **Voltage:** 190-480 VAC
- **Frequency:** 50/60 Hz
- **Adjustable DOB:** .1-5 minutes
- **Adjustable DOM:** .1-5 minutes
- **N.O./N.C. contacts:** 10 amps resistive @ 250 VAC
- **Power/phase loss detection:** within 100 ms
- **User selectable unbalance voltage:** 2 to 8%
- **User selectable delay on make:** .1 to 5 minutes
- **Dimensions:** 4.25" x 3.50" x 2.37"

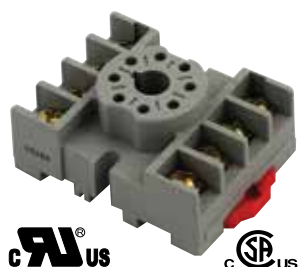

## ACS-8

### FEATURES/APPLICATION

- Relay socket
- 8-octal plug-in base – Order **ACS-8**
- Locating key ensures proper orientation
- For use with **ICM408** three-phase monitors

### SPECIFICATIONS

- 10 amps up to 480 VAC
- **Dimensions:** 1.65" x 2.15" x 1.00"

### REPLACES

- **Diversified:** RB-08



## ICM441

### FEATURES/APPLICATION

- Protects Against:
  - Under voltage
  - Over temperature
  - Power interruptions
  - Rapid short cycling
- Shorted temperature sensor
- Open temperature sensor
- Control duty, SPST relay layout
- Anti-short cycle time delay, 4 minutes (nominal)
- 1-second manual bypass

### SPECIFICATIONS

- **Voltage:** 120 or 208/240 VAC
- **Frequency:** 50/60 Hz
- **Output:**
  - **Relay:** SPST
  - **N.O.:** 6 amps resistive
- **Dimensions:** 3.00" x 3.20" x 1.35"

### REPLACES

- **Bristol:** 241680
- **Copeland:** 071-0376-01, 071-0376-02, 071-0397-00, 071-0397-01, 071-0424-00, 071-0424-01, 071-9800-00, 071-9800-01
- **Mars:** 37300, 37302, 37304, 37306, 37322
- **Texas Instruments:** 15AA1600 B, 15AA1600 C, 15AA1603 B, 15AA1603 C, 31AA1600 E, 31AA1606 E

## ICM442

### FEATURES/APPLICATION

- Protects against over temperature in motor windings
- Uses up to four (4) 100 Ohm thermistors in series

### SPECIFICATIONS

- **Voltage:** 200-575 VAC
- **Frequency:** 50/60 Hz
- **Voltage unbalance:** Adjustable: 2-25%
- **Control:** 115-277 VAC
- **Control Duty SPST Relay Layout:** 10 amps, 250 VAC
- **Thermistors:** Four (4) 100Ω thermistors in series
- **Relay Rating:** 250 VAC at 10 A
- **Dimensions:** 3.00" x 3.20" x 1.35"



## ICM443

### FEATURES/APPLICATION

- Protects against over temperature in motor windings
- Uses up to four (4) 100 Ohm thermistors in series

### SPECIFICATIONS

- **Voltage:** 200-575 VAC
- **Frequency:** 50/60 Hz
- **Voltage unbalance:** Adjustable: 2-25%
- **Heavy duty SPST relay output:** 10 amps, 250 VAC
- **Control:** 24 VAC
- **Thermistors:** Four (4) 100Ω thermistors in series
- **Relay Rating:** 250 VAC at 10 A
- **Dimensions:** 3.00" x 3.20" x 1.35"

## SINGLE PHASE VOLTAGE MONITORS



### ICM491

#### FEATURES/APPLICATION

- Low cost single-phase voltage protection
- Built in anti-short cycle protection
- Detects high/low voltage conditions
- Helps prevent rapid system recycling
- LED indicators: **Green** (normal)  
**Red** (fault)
- Heavy duty SPDT, isolated relay output
- Interrogation ON delay prevents nuisance trips: 5 seconds

#### SPECIFICATIONS

- **Voltage:** 95-270 VAC
- **Output:**
  - **Relay:** SPDT
  - **N.C./N.O.:** 5 amps
- **Time delay range:** 6-600seconds  
(.1 - 10 minutes)
- **Dimensions:** 3.00" x 3.20" x 1.35"

#### REPLACES

- **A-1:** EAC-401, EAC-402, EAC-403, EAC-404
- **Diversified:** CV-100-RS, CV-200-RS15, CV-200-RS20
- **Wagner/DiversiTech:** DSP-1

### ICM492

#### FEATURES/APPLICATION

- Protects against over and under voltage, and rapid short cycling caused by transient faults and power interruptions
- Easy-view, backlit digital display
- Adjustable voltage set point
- Adjustable anti-short cycle time delay
- Adjustable response time
- Control mode (optional)
- 5-fault memory
- Universal line voltage input
- Heavy duty SPDT relay output
- Universal control voltage input (for integrating a thermostat)

#### SPECIFICATIONS

- User adjustable settings:**
- **Voltage set point:** 80-300 VAC
  - **Anti-short cycle time delay:** 0-720 seconds
  - **Over/under voltage setting:** 5-25%
  - **Control mode:** ON and OFF
  - **Response time:** 0.1-10 seconds
  - **Line voltage:** 80-300 VAC
  - **Frequency:** 50/60 Hz
  - **Accuracy:** ±2%
  - **Low power consumption:**
    - Maximum 50 mA @ 120 VAC
    - Maximum 100 mA @ 240 VAC
  - **Voltage:** 18-240 VAC
  - **Type:** Dry relay contacts
  - **Form:** SPDT
  - **Relay contact ratings:**
    - **N.C. contacts:** 10A resistive @ 277 VAC
    - **N.O. contacts:** 10A resistive @ 277 VAC
  - **Dimensions:** 3.00" x 3.20" x 1.35"

#### REPLACES

- **Wagner/DiversiTech:** DSP-1



## SINGLE-PHASE VOLTAGE MONITORS WITH SURGE PROTECTION



### ICM493

#### FEATURES/APPLICATION

- Protects against over and under voltage, rapid short cycling caused by transients, and high-power surges
- Easy to view, backlit digital display
- Bank of five L-L surge arresters
- Built-in 40A contactor
- NEMA Type 3R rated enclosure for outdoor use
- Easy installation and setup

#### SPECIFICATIONS

- **Voltage set point:** 200-240 VAC
- **Over/under voltage setting:** 5% - 10%, adjustable
- **Anti-short cycle delay:** 0.5-10 min.
- **# of surge arresters required for operation:** 0-5
- **Accuracy:** +/- 2%, user calibration
- **Contactor ratings:** 40A FLA, 240A LRA
- **Dimensions:** 8.00" x 8.25" x 4.30"
- **Number of trials:** 1-5, auto
- **Line voltage:** 180-264 VAC
- **Frequency:** 50/60 Hz
- **Type:** Contactor, 2-pole

### ICM493-60A

#### FEATURES/APPLICATION

- Protects against over and under voltage, rapid short cycling caused by transients, and high-power surges
- Ideal for mini-splits or other condensing units
- Easy to view, backlit digital display
- Bank of five L-L surge arresters
- Built-in 60A contactor
- NEMA Type 3R rated metal enclosure

#### SPECIFICATIONS

- **Input:** 195-264 VAC, 50/60Hz
- **Voltage:** 240 VAC
- **FLA:** 60A, **LRA:** 360A
- **Operating/storage/LCD temp.:** -40°F to 167°F
- **Enclosure:** Weather resistant, NEMA 3R rated for outdoor installation
- **ASC time delay:** 0.5-10 minutes
- **# of trials:** 1-5, auto,
- **# of movistors:** 0-5
- **Dimensions:** 8.00" x 10.00" x 6.00"





## COMMON CAUSES OF POWER SURGES:

- Lightning storms
- Downed power lines
- Substandard / incorrect wiring
- Power outages/system recovery grid overload
- Large appliances turning On/Off
- Old electrical components
- Short circuits
- Loose wiring



## ICM SURGE PROTECTIVE DEVICES

### Why do you need protection?

All homes are constantly under attack from power surges and spikes, even though they may not always be apparent. These energy irregularities can be caused from just about anything, including weather, poor wiring, old parts, not to mention an aging power grid that has difficulty handling today's energy demands. Over time, these repeated energy surges will wear down your equipment and reduce its life expectancy. It is common for homeowners to place surge protectors on their televisions, personal computers and appliances. However, people often forget about their HVAC system, which represents your home's most valuable electronic investment.

### Why ICM Controls?

You can't see the harmful surges and transients in your power lines, but ICM's products can! For more than 30 years, ICM Controls has been a recognized leader for manufacturing controls that protect your valuable HVAC equipment against today's most common and severe power threats. From basic surge protective devices to line voltage monitors to combination devices, ICM Controls has you covered. Consult your local HVAC contractor to determine which control is right for your application.

Located in North Syracuse, NY, ICM's quality products are proudly manufactured in the USA.



PHONE: 1-800-365-5525 FAX: 315-233-5276 WEB: [WWW.ICMCONTROLS.COM](http://WWW.ICMCONTROLS.COM)

All features and specifications are subject to change without notice.



# SURGE PROTECTION DEVICES

## SINGLE-PHASE SURGE PROTECTORS



### ICM517

#### FEATURES/APPLICATION

- Easy installation
- Low cost, high performance
- Rugged, reliable
- UL Listed, Type 2 device
- NEMA Type 3R metal enclosure

#### SPECIFICATIONS

- **Service voltage:** 120/240 volt, single phase
- **Max. surge current:** 100,000 Amps
- **Max. energy dissipation:** 1,020 Joules
- **Installation point:** Electrical panel/disconnect
- **Diagnostics:** Green light indicates surge suppression present
- **AC protection modes:** L-L, L-N, L-G, N-G
- **Conduit connection:** 3/4"
- **Weight:** 0.55 lbs.
- **Dimensions:** 5.0" x 2.78" x 2.16"

## SPLIT PHASE SURGE PROTECTIVE DEVICE



### ICM518

#### FEATURES/APPLICATION

- 240 VAC split surge protective device
- Easy 3-wire installation
- 3/4" conduit connection
- Green LED indicator tells whether the device is operational
- Low cost, high performance
- Rugged and reliable
- UL Listed Type 1 or Type 2 SPD
- NEMA Type 4X watertight enclosure for indoor/outdoor use
- Limited Lifetime Protection Warranty

#### SPECIFICATIONS

- **Service voltage:** Split 240 VAC
- **Short Circuit Current Rating (SCCR):** 200 kA
- **Nominal discharge current (In):** 20 kA
- **Protection mode:** L1-L2, L1-N, L2-N
- **Maximum Continuous Operation Voltage (MCOV):**
  - L-L: 300 VAC
  - L-N: 150 VAC
- **VPR:**
  - L-L: 1200 VAC
  - L-N: 700 VAC
- **SPD type:** Type 1 (can also be used in Type 2 apps)
- **Surge protection technology:** TFMOV
- **Input power frequency:** 50/60 Hz
- **Dimensions:** 4.30" x 4.10" x 2.30"

#### REPLACES

- **ASCO:** 420120S
- **Eaton:** SP1-240S, SP2-240S
- **ERICO (Critec):** TDX50C240
- **Generac:** G0073000
- **Intermatic:** AG2401C3, IG1200RC3, IG1240RC3, IG3240RC3
- **Leviton:** 55240-ASA
- **MARS:** 83905
- **Siemens:** TPS3A

## 3-PHASE DELTA OR WYE CONFIGURATION



## ICM530

## FEATURES/APPLICATION

- 240 VAC or Wye 120/208 VAC
- Delta or Wye Configuration
- NEMA Type 4X watertight plastic enclosure for outdoor and indoor installation
- Green LED indicates surge protection present
- Easily connects to electrical panel or disconnect for indoor and outdoor apps
- UL Listed Type 1 or Type 2 SPD
- Limited Lifetime Protection Warranty

## REPLACES

- **ABB:** OVRHLDxx-120
- **ASCO:** 420120Y, 420240D
- **Eaton:** SP1-208Y, SP1-240D, SP2-208Y, SP2-240D
- **ERICO (Critec):** TXD50C120/208, TXD50C120/240D
- **Intermatic:** AG2083C3 L5F13Y1DG1
- **Leviton:** 55208-ASA
- **Siemens:** TPS3D, TPS3C
- **Square D:** SDSA2040, SDSA2040D

## SPECIFICATIONS

- **Service voltage (3-phase):** 240 VAC Delta or 120/208 VAC Wye
- **Short Circuit Current Rating (SCCR):** 200 kA
- **Nominal discharge current (In):** 20 kA
- **Protection mode:**
  - 3 for Delta configuration
  - 6 for Wye configuration (neutral tied to ground)
- **Maximum Continuous Operation Voltage (MCOV):**
  - **L-L:** 300 VAC
  - **L-N:** (for Wye configuration only): 150 VAC
- **VPR:**
  - **Delta L-L:** 1200 VAC
  - **Wye L-L:** 1200 VAC
  - **Wye L-N:** 700 VAC
- **SPD type:** Type 1 (can also be used in Type 2 applications)
- **Surge protection technology:** TFMOV
- **Input power frequency:** 50/60 Hz
- **Dimensions:** 4.30" x 4.10" x 2.30"



## ICM531

## FEATURES/APPLICATION

- 480 VAC or Wye 277/480 VAC
- Delta or Wye Configuration
- NEMA Type 4X watertight plastic enclosure for outdoor and indoor installation
- Green LED indicates surge protection present
- Easily connects to electrical panel or disconnect for indoor and outdoor apps
- UL Listed Type 1 or Type 2 SPD
- Limited Lifetime Protection Warranty

## REPLACES

- **ABB:** OVRHLDxx-277
- **ASCO:** 420277Y, 420480D
- **Eaton:** SP1-480Y, SP1-480D, SP2-480Y, SP2-480D
- **ERICO (Critec):** TDX50C277/480
- **Intermatic:** AG4803C3, L5F13Y2DG1
- **Leviton:** 55480-ASA
- **Siemens:** TPS3E, TPS3F
- **Square D:** SDSA4040, SDSA4040D

## SPECIFICATIONS

- **Service voltage (3-phase):** 480 VAC Delta or 277/480 VAC Wye
- **Short Circuit Current Rating (SCCR):** 200 kA
- **Nominal discharge current (In):** 20 kA
- **Protection mode:**
  - 3 for Delta configuration
  - 6 for Wye configuration (neutral tied to ground)
- **Maximum Continuous Operation Voltage (MCOV):**
  - **L-L:** 700 VAC
  - **L-N:** (for Wye configuration only): 350 VAC
- **VPR:**
  - **Delta L-L:** 2500 VAC
  - **Wye L-L:** 2500 VAC
  - **Wye L-N:** 1200 VAC
- **SPD type:** Type 1 (can also be used in Type 2 applications)
- **Surge protection technology:** TFMOV
- **Input power frequency:** 50/60 Hz
- **Dimensions:** 4.30" x 4.10" x 2.30"



## ICM532

## FEATURES/APPLICATION

- 600 VAC or WYE 347/600 VAC
- Delta or Wye Configuration
- NEMA Type 4X watertight plastic enclosure for outdoor and indoor installation
- Green LED indicates surge protection present
- Easily connects to electrical panel or disconnect for indoor and outdoor apps
- UL Listed Type 1 or Type 2 SPD
- Limited Lifetime Protection Warranty

## REPLACES

- **ASCO:** 420347Y, 420600D
- **Eaton:** SP1-600Y, SP1-600D, AP2-600Y
- **ERICO (Critec):** TXD50C347/600
- **Intermatic:** AG6503, L5F13Y3DG1
- **Siemens:** TPS3L, TPS3G
- **Square D:** SDSA3650, SDSA3650D

## SPECIFICATIONS

- **Service voltage (3-phase):** 600 VAC Delta or 347/600 VAC Wye
- **Short Circuit Current Rating (SCCR):** 200 kA
- **Nominal discharge current (In):** 20 kA
- **Protection mode:**
  - 3 for Delta configuration
  - 6 for Wye configuration (neutral tied to ground)
- **Maximum Continuous Operation Voltage (MCOV):**
  - **L-L:** 920 VAC
  - **L-N:** (for Wye configuration only): 460 VAC
- **VPR:**
  - **Delta L-L:** 2500 VAC
  - **Wye L-L:** 2500 VAC
  - **Wye L-N:** 1500 VAC
- **SPD type:** Type 1 (can also be used in Type 2 applications)
- **Surge protection technology:** TFMOV
- **Input power frequency:** 50/60 Hz
- **Dimensions:** 4.30" x 4.10" x 2.30"



## ICM533

### FEATURES/APPLICATION

- High Leg 120/240 VAC
- Delta High-Leg Configuration
- NEMA Type 4X watertight plastic enclosure for outdoor and indoor installation
- Green LED indicates surge protection present
- Easily connects to electrical panel or disconnect for indoor and outdoor applications
- UL Listed Type 1 or Type 2 SPD
- Limited Lifetime Protection Warranty

### REPLACES

- **ASCO:** 420240H
- **Eaton:** SPD050240H1
- **Intermatic:** AG2403C3, L5F13D1DG1
- **Siemens:** TPS3B
- **Square D:** SDSA2040D

### SPECIFICATIONS

- **Service voltage (3-phase):** 120/240 VAC Delta High-Leg
- **Short Circuit Current Rating (SCCR):** 200 kA
- **Nominal discharge current (In):** 20 kA
- **Protection mode:** 3 for Delta configuration
- **Maximum Continuous Operation Voltage (MCOV):**
  - L-L: 300 VAC
  - L-N: 150 VAC
  - H-L: 450 VAC
  - H-N: 300 VAC
- **VPR:**
  - L-L: 1200 VAC
  - L-N: 700 VAC
  - H-L: 1500 VAC
  - H-N: 900 VAC
- **SPD type:** Type 1 (can also be used in Type 2 applications)
- **Surge protection technology:** TFMOV
- **Input power frequency:** 50/60 Hz
- **Dimensions:** 4.30" x 4.10" x 2.30"

## MOTOR STARTERS

### SOFT START CONTROLS



## ICM870 9A/16A/32A

### FEATURES/APPLICATION

- Starting current reduction and self-learning algorithm
- Built-in start capacitor
- Over/under voltage monitoring
- Over-current protection
- Diagnostic indicators
- Sealed enclosure
- 9A Model – Order: **ICM870-9A**
- 16A Model – Order: **ICM870-16A**
- 32A Model – Order: **ICM870-32A**

### SPECIFICATIONS

- **Inputs:** L1 & L2
- **Nominal voltage:** 120 VAC, 240 VAC
- **Over voltage limits:** 120 VAC nominal = 140 VAC  
240 VAC nominal = 250 VAC
- **Under voltage limits:** 120 VAC nominal = 95 VAC  
240 VAC nominal = 195 VAC
- **Outputs:** Compressor
- **Current:** Maximum nominal = 9 A, 16A, 32A
- **Over current limits:** ICM870-9A = 11.25A  
ICM870-16A = 20A  
ICM870-32A = 40A
- **Operating temp.:** -40°F to 131°F (-40°C to 55°C)
- **Storage temp.:** -40°F to 149°F (-40°C to 65°C)
- **Humidity:** 0-95% non-condensing
- **Enclosure:** IP65/Type 4X
- **Dimensions:** ICM870-9A/16A (7.60" x 3.20" x 2.10")  
ICM870-32A (7.94" x 4.20" x 2.10")

## VOLTAGE SENSING

ICM's differential voltage sensing products employ patented circuitry which monitors differential compressor auxiliary voltage, determines the state of the motor and precisely engages and disengages the start capacitor.

A timed safety circuit is provided in the event the motor fails to start within 2 seconds.

## ICM866U

### FEATURES/APPLICATION

- Patented circuitry with differential voltage sensing technology
- Monitors differential compressor auxiliary voltage
- Not affected by ambient temperatures
- Recycles instantly
- Self-adjusting to changes in voltages
- Extends motor life
- Rated for 1/12 to 5 HP applications
- Reduces inventory, saves money – One model is all you need
- Simple, two-wire installation
- Multi-voltage operation for 115 or 230 VAC motors
- Precisely engages/disengages the start capacitor
- Does not rely on relay with preset, factory default ranges
- Faster install time and minimizes risk of accidental miswires

### SPECIFICATIONS

- **Voltage:** 90-240 VAC
- **Recommended range:** 1/12 to 5 HP
- **Capacitor:** 145-175 Mfd. 330 V
- **Dimensions:** 7.90" x 1.50" x 2.25"

### REPLACES

- **Supco:** SPP5, SPP6, SPP5E, SPP6E, SPP7E, SPP8E, SPP9E, SPP10E
- **Kickstart:** KS1-KS5 & KS8
- **5-2-1:** CSR-U1, CSR-U2, CSR-U3
- **Watsco:** WSX1
- **Mars:** 32708, SS1, SS5, 32703, 32704, 32701, 32702
- **DiversiTech:** DST-5, DST-6



## PTCR HARD START CAPACITORS



### ICM855

#### FEATURES/APPLICATION

- Increases torque up to 300%
- Positive Temperature Coefficient (PTC) technology
- Easy to install
- Low cost motor starting device

#### SPECIFICATIONS

- **Voltage:** 115-288 VAC
- **Capacitor:** 43-52 Mfd, 330 V
- **Range:** 1/2 to 10 HP
- **Dimensions:** 2.50" x 1.75" x 6.25"

#### REPLACES

- **A-1:** WXS-5
- **MARS:** 32701, 35701
- **Supco:** SPP-5
- **Wagner/DiversiTech:** DST-5

### ICM856

#### FEATURES/APPLICATION

- Increases torque up to 500%
- Positive Temperature Coefficient (PTC) technology
- Easy to install
- Low cost motor starting device

#### SPECIFICATIONS

- **Voltage:** 115-288 VAC
- **Capacitor:** 130-156 Mfd, 330 V
- **Range:** 1/2 to 10 HP
- **Dimensions:** 2.00" x 2.00" x 6.50"

#### REPLACES

- **A-1:** WXS-6
- **MARS:** 32702, 35702
- **Supco:** SPP-6
- **Wagner/DiversiTech:** DST-6



## RELAY, OVERLOAD AND START CAPACITORS



### ICM857

#### FEATURES/APPLICATION

- For single-phase commercial and domestic capillary refrigeration systems and freezers
- Pre-wired for fast installation
- Overload: 12A
- 145-175 mfd
- For 1/12 to 1/5 HP motors

#### SPECIFICATIONS

- **Voltage:** 120 VAC
- **Maximum voltage:** 180 VAC
- **Maximum current:** 12A
- **Retry time:** Within 90 seconds
- **Dimensions:** 2.30" x 2.00" x 5.15"

#### REPLACES

- **Mars:** 32781
- **Supco:** RCO810

### ICM858

#### FEATURES/APPLICATION

- For single-phase commercial and domestic capillary refrigeration systems and freezers
- Pre-wired for fast installation
- Overload: 22A
- 243-292 mfd
- For 1/4 to 1/3 HP motors

#### SPECIFICATIONS

- **Voltage:** 120 VAC
- **Maximum voltage:** 180 VAC
- **Maximum current:** 12A
- **Retry time:** Within 90 seconds
- **Dimensions:** 2.30" x 2.00" x 5.75"

#### REPLACES

- **Mars:** 32741
- **Supco:** RCO410



### ICM859

#### FEATURES/APPLICATION

- For single-phase commercial and domestic capillary refrigeration systems and freezers
- Pre-wired for fast installation
- Overload: 30A
- 243-292 mfd
- For 1/3 to 1/2 HP motors

#### SPECIFICATIONS

- **Voltage:** 120 VAC
- **Maximum voltage:** 180 VAC
- **Maximum current:** 12A
- **Retry time:** Within 90 seconds
- **Dimensions:** 2.60" x 2.20" x 6.25"

#### REPLACES

- **Supco:** RCO210

# UMSR – UNIVERSAL MOTOR STARTING RELAY

ICM's Universal Motor Starting Relay incorporates patented differential voltage sensing and a non-positional mounting configuration to offer a single replacement for all standard potential relays. Ideal for A/C, commercial refrigeration, heat pump or any single-phase motor application up to 10 HP.



## UMSR-50

### FEATURES/APPLICATION

- Replacement for all standard potential relays
- Patented differential voltage sensing
- No user-adjustments required
- Non-positional mounting configuration
- 50A switching capabilities
- Universal mounting bracket for easy installation
- .250" quick connect termination
- Safety timer

### SPECIFICATIONS

- **Voltage rating:** 110-270 VAC, Single Phase
- **Max. voltage contact rating:** 502 VAC (absolute)
- **Motor power rating:** Up to 10 HP
- **Operating position:** Non-positional
- **Safety time out:** Approximately 1-second per 100 microfarads
- **Consumption:** 5 VA max.
- **Contact rating:** 50A (break only)
- **Dimensions:** 2.00" x 2.00" x 1.75"

### REPLACES

- All standard potential relays
- **Supco:** APR5, SUPR



## Wiring Diagrams

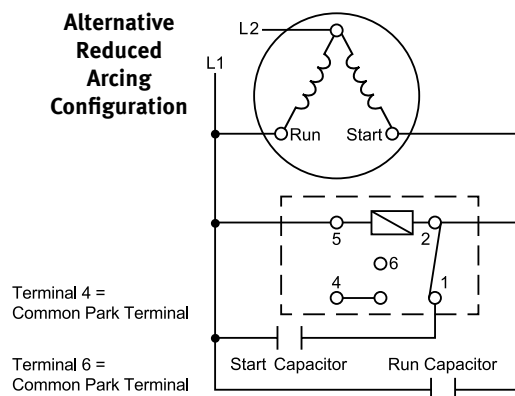
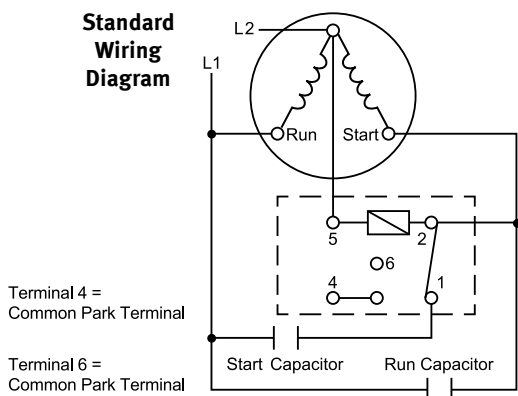

# ECM CONTROLS

## ELECTRONICALLY COMMUTATED MOTOR

ICM's controllers provide a line of form, fit and functional OEM replacements for efficiently controlling a motor's speed.

Manual or automated control of an ECM is available (model dependent), while monitoring and displaying the RPM/CFM of the motor.



### ICM708

#### FEATURES/APPLICATION

A low current pulse width modulated signal for controlling the speed of a GE 2.3 ECM based on a user settable potentiometer.

#### RPM Feedback

On-board LED diagnostics for a visual indication of the motor's status.

#### SPECIFICATIONS

- **Power supply:** 18-30 VAC
- **RPM input:** 5 VDC
- **PWM & ON/OFF outputs:** 14 VDC (PWM 80 Hz)
- **Dimensions:** 4.25" x 2.35" x 1.50"

#### REPLACES

- **EVO™/ECM-VCU-36-mp**

### ICM709

#### FEATURES/APPLICATION

A low current pulse width modulated signal for controlling the speed of a GE 2.3 ECM based on user settable potentiometers (SET0 - SET4) and a thermostat's requested call.

#### RPM Feedback

On-board LED diagnostics for a visual indication of the motor's status.

#### SPECIFICATIONS

- **Power supply:** 18-30 VAC
- **RPM input:** 15 VDC
- **Thermostat inputs: (SPD1 - SPD4):** 18-30 VAC
- **PWM & ON/OFF outputs:** 14 VDC (PWM 80 Hz)
- **Dimensions:** 3.25" x 3.00" x 0.75"

#### REPLACES

- **EVO™/ECM-4Spd**



### ICM711

#### FEATURES/APPLICATION

The ICM711 is used to control the speed of an Electronically Commutated Motor (ECM) by automated control systems via a 0-10 VAC input (**SIGNAL & COMMON**), or manually via potentiometer (**SET SPEED**). The ICM711 will also provide motor speed feedback via visual LED indication (**MOTOR RPM**) as well as a 0-10 VAC output (**RPM & COMMON**) to supply an automated control system.

#### SPECIFICATIONS

- **Power supply:** 18-30 VAC, 60 Hz
- **Signal & common:** 0-10 VDC → 0-100% PWM request
- **ECM supplied feedback:** 5 VDC (motor at rest or not connected)
- **PWM supplied to ECM:** 18 VDC (10mA max)
- **ON/OFF supplied to ECM:** 18 VDC (10mA max)
- **RPM & common:** 0-10 VDC (5mA max) → 0 to 2000 RPM (10 RPM increments)
- **Dimensions:** 4.25" x 2.35" x 1.50"

#### REPLACES

- **EVO™/ECM-ACU+-S1**

### ICM712

#### FEATURES/APPLICATION

The ICM712 is a motor speed controlling interface for use with a low voltage thermostat or automated control unit to control the ECM's output.

#### SPECIFICATIONS

- **24 VAC thermostat inputs:** 0, MED, HIGH, Y1 & LOW
- **PWM input:** BK/PWM
- **Electrical rating:** 24 VAC (18-30 VAC)
- **Dimensions:** 3.00" x 3.00" x 1.60"

#### REPLACES

- **IEC:** E025-71521506

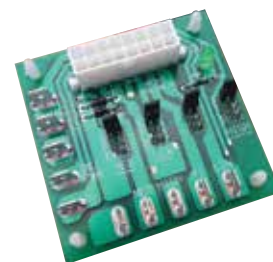



## ICM713

### FEATURES/APPLICATION

- Single or dual temperature inputs
- Heat pump bypass circuitry
- Low current pulse width modulated output
- Lead free design

### SPECIFICATIONS

- **Voltage:** 18-30 VAC
- **Frequency:** 50/60 Hz
- **Output:** 13.5 VDC, 10mA max., 80 Hz, 0-100%
- **Operating temperature:** -40°F to 158°F
- **Storage temperature:** -40°F to 185°F
- **Temperature probes:** 10 KOhm (NTC, J-Curve)
- **Dimensions:** 5.00" x 3.25" x 1.50"

### REPLACES

- **Hoffman:**  
880-ECM(10)SSHP

## ICM715

### FEATURES/APPLICATION

- Provides a single, user selected motor speed when replacing an OEM constant torque electronically commutated motor
- Simple installation
- Works on constant torque blower motor such as X13 or SelecTech constant torque electronically commutated motor up to 1 HP
- User selectable 3 minute delay on break option

### SPECIFICATIONS

- **Motor voltage:** 120 VAC or 208-240 VAC
- **Input voltage:** 24 VAC
- **Input frequency:** 50-60 Hz
- **Horse power:** 1 HP max.
- **Dimensions:** 4.00" x 2.25" x 1.25"

### REPLACES

- QwikSwapX1



## ICM716

### FEATURES/APPLICATION

- Provides a means to replace an X13 or SeleTech constant torque ECM with a single phase PSC motor
- Eliminates costly ECM repairs
- 3 High power relay outputs for automated speed selection
- 3 LED's indicate selected speed
- LED indicator illuminates when OFF delay is active
- User selectable 60, 120, or 180 second OFF delay

### SPECIFICATIONS

- **Motor voltage:** 120 VAC or 208-240 VAC
- **Input voltage:** 24 VAC
- **Input frequency:** 50-60 Hz
- **Horse power:** 1 HP max.
- **Dimensions:** 5.00" x 3.75" x 1.25"

### REPLACES

- QwikSwapX3

# FAN COIL RELAY CONTROL BOARDS



## ICM6202

### FEATURES/APPLICATION

- Ability to operate line voltage 3-speed fan motor with low voltage controls
- Compatible with 4-pipe and 2-pipe systems with auto-changeover
- Suitable for 1/8 HP motors
- 1/4" Quick connect terminals
- Mounts with standard 3" track

### SPECIFICATIONS

#### Input:

- **Transformer primary:** 115 VAC/230 VAC; 50/60 Hz
- **Fan inputs HI, MED, LOW:** Nominal 17mA @ 24 VAC
- **Heat & cool:** 0.83A @ 24 VAC

#### Outputs:

- **Transformer secondary:** 24 VAC, 20 VA
- **Relay outputs H, M, L:** 1/8HP @ 115 VAC, 10A @ 240 VAC resistive
- **Heat & cool valves:** 0.83A @ 24 VAC
- **Dimensions:** 5.85" x 3.00" x 1.75"





# FAN BLOWER CONTROLS

## AIR HANDLING CONTROLLERS

### ICM6500-1

#### FEATURES/APPLICATION

- Multi-functional control
- Microprocessor controlled
- Precision timing
- Low cost solution

#### SPECIFICATIONS

- **Voltage:** 24 VAC, 120/240 VAC, 50/60 Hz
- **Valve output:** 24 VAC, 50/60 Hz, 5A
- **Blower fan:** 120/240 VAC, 50/60 Hz, 13A/6.5A
- **Water pump:** 120/240 VAC, 50/60 Hz, 1.5A/1.5A
- **Boiler:** 24 VAC, 50/60 Hz, 5A
- **ECM Output:** 24 VAC, 5A
- **Timing:**
  - **Cool fan ON delay:** 0 seconds
  - **Cool fan OFF delay:** 45 seconds
  - **Electric heat fan ON delay:** 0 seconds
  - **Electric heat fan OFF delay:** 0 seconds
  - **Water heat fan ON delay:** 60 seconds
  - **Water heat fan OFF delay:** 30 seconds
- **Dimensions:** 2.00" x 7.00" x 1.25"

#### REPLACES

- **Vtronics:** R200A



### ICM6501

#### FEATURES/APPLICATION

- Air handler control board operates with hot water heating systems
- Features both preheat and post-purge fan blower delays

#### SPECIFICATIONS

- **Voltage:** 120 VAC or 208-240 VAC
- **Input voltage:** 24 VAC
- **Input frequency:** 50-60 Hz
- **Horse power:** 1 HP max.
- **Surrounding air temperature rating:** -40°F to 167°F
- **Dimensions:** 4.00" x 2.25" x 1.25"

#### REPLACES

- **ClimaTek/First Company:** CB201

## POST PURGE, OFF DELAY TIMER

### Application

Controls the circulating fan in heat pump, air conditioning and forced air systems. OFF delay timing function continues to run the fan at the end of the heating/cooling cycle, thereby purging ducts of residual air and increasing system efficiency.

### Mode of Operation

Power must be applied before and during the time delay period. When the initiate contact closes, the load energizes and remains energized as long as the initiate contact is closed. The time delay begins when the initiate contact opens. At the end of the time delay period, the load is turned off. If the initiate contact recloses during the time delay period, the load remains energized and the time delay is reset to zero. Removal of the input power during the delay turns off the load and resets the time delay to zero. A one-second interrogation delay is provided to avoid nuisance trips due to thermostat bounce or tampering.



### ICM253

#### FEATURES/APPLICATION

- UL 873 recognition for compressor applications
- Post-purge fan delay timer
- OFF delay purges ducts of residual air at the end of the heating/cooling cycle
- Interrogation delay eliminates nuisance trips due to thermostat bounce/tampering

#### SPECIFICATIONS

- **Voltage:** 18-30 VAC
  - 1 amp maximum
  - 40 mA minimum
  - 10 amp inrush
- **Adjustable time delay:**
  - **OFF:** 12-390 seconds
- **Dimensions:** 3.00" x 2.00" x 1.25"

#### REPLACES

- **Field Controls:** 46144700
- **Gemline:** 1C216
- **Mars:** 32393

## OFF DELAY ON BREAK

### Applications

“OFF delay on break”

Controls the circulating fan in heat pump, air conditioning and forced air systems. OFF delay timing function continues to run the fan at the end of the heating/cooling cycle, thereby purging ducts of residual air and increasing system efficiency.

### Mode of Operation

Power must be applied before and during the time delay period. When the initiate contact closes, the load energizes and remains energized as long as the initiate contact is closed. The time delay begins when the initiate contact opens. At the end of the time delay period, the load is turned off. If the initiate contact recloses during the time delay period, the load remains energized and the time delay is reset to zero. Removal of the input power during the delay turns off the load and resets the time delay to zero. A one-second interrogation delay is provided to avoid nuisance trips due to thermostat bounce or tampering.



### ICM255

#### FEATURES/APPLICATION

- Low cost open board design
- High power, relay output
- Dual function fan delay timer
- Controls the circulating fan in heat pump, A/C and forced air systems
- OFF delay purges ducts of residual air

#### SPECIFICATIONS

- **Voltage:** 18-30 VAC
- **Contact ratings:**
  - **N.O.:** 20 amps @ 240 VAC
  - **N.C.:** 20 amps @ 240 VAC
- **Time delays fixed:**
  - **ON:** 1 second
  - **OFF:** 60 seconds
- **Dimensions:** 2.50" x 2.50" x 1.50"

#### REPLACES

- **A-1:** 5893
- **Bard:** 8201-056
- **Mars:** 32574
- **Rheem** 42-22515-01, 42-22515-02, 42-22515-03
- **Snyder General/ICP:** 1395336

## FORM, FIT AND FUNCTIONAL OEM REPLACEMENT PARTS

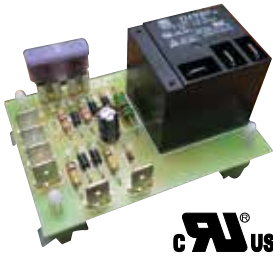

### ICM256

#### FEATURES/APPLICATION

- Fan post purge timer to control circulating fan in forced air systems
- Dual function 7 second ON delay / 65 second OFF delay
- Speed up terminals for test mode
- Fuse protected control voltage
- High power relay output

#### SPECIFICATIONS

- **Input**
  - **Voltage:** 18-30 VAC
  - **Frequency:** 50/60 Hz
- **Output**
  - **Type:** Relay
  - **Form:** SPST N.O.
  - **Rating:** 25 amps @ 240 VAC
- **Time Delays**
  - **ON delay:** 7 seconds
  - **OFF delay:** 65 seconds

#### Speed Up Options

- **Speed up to C** = Reduced delay (3 seconds ON, 5 seconds OFF)
- **Speed up to R** = No delay
- **Dimensions:** 2.85" x 2.00" x 2.00"

#### REPLACES

- **Goodman:** PCBFM-103

### ICM271

#### FEATURES/APPLICATION

- Reliable solid state fan blower control
- Pin selectable blower delays
- High power, relay output
- Dual function fan delay timer
- Controls the circulating fan in HP, A/C and forced air systems
- OFF delay purges ducts of residual air
- ON delay allows air to reach the proper comfort level prior to energizing the fan

#### SPECIFICATIONS

- **Voltage:** 18-30 VAC
- **Contact ratings:**
  - **N.O.:** 20 amps
  - **N.C.:** 10 amps
- **Time delays:**
  - **Heat ON delay:** 75 seconds
  - **Heat OFF delay:** 105 seconds
  - **Cool OFF delay:** 90 seconds
- **Dimensions:** 2.85" x 2.00" x 2.00"

#### REPLACES

- **Carrier:** 302075-3, CES0110017, CES0110018, HH84AA010, HH84AA011, HH84AA012, HH84AA013, HH84AA020, P771-7002
- **Robertshaw:** 695-100



### ICM275

#### FEATURES/APPLICATION

- Form, fit and functional OEM replacement control
- Heavy duty heat relay
- Purges ducts of residual air
- Integral short cycle protection

#### SPECIFICATIONS

- **Voltage:** 18-30 VAC
- **Contact ratings:**
  - **High:** 20 amps @ 240 VAC
  - **Low:** 10 amps @ 240 VAC
- **Time delays:**
  - **Heat ON delay:** 60 seconds
  - **Heat OFF delay:** 60-240 seconds
  - **Cool OFF delay:** 90 seconds
- **Dimensions:** 5.43" x 5.25" x 1.00"

#### REPLACES

- **Carrier:** CES0110019, HH84AA001, HH84AA003, HH84AA005, HH84AA009, HH84AA014, HH84AA015, HH84AA021
- **Robertshaw:** 695-101

## ICM277

### FEATURES/APPLICATION

- Microprocessor-based fan blower
- For circulating fan in heat pump, A/C and forced air systems

### SPECIFICATIONS

- **Voltage:** 18-30 VAC
- **Contact ratings:**
  - **N.O.:** 20 amps
  - **N.C.:** 10 amps
- **Time delays:**
  - **Blower ON:** 7 seconds
  - **Blower OFF:** 65 seconds
- **Dimensions:** 4.50" x 2.00" x 1.25"

### REPLACES

- **Goodman:** B1370735S, PCBFM131S

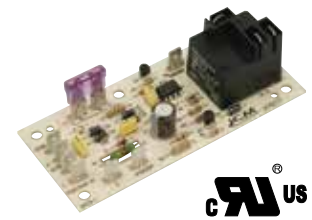

## FURNACE CONTROLS

ICM offers low cost, form, fit and functional replacement furnace controls for many popular OEM models. Our furnace controls come standard with many safety features including 100% gas shutoff in case of ignition failure.



## ICM280

### FEATURES/APPLICATION

- Controls gas valve, ignitor, blower motor, inducer.
- Microprocessor-based
- Status LED for fault codes
- Twinning compatible with another **ICM280** board

### SPECIFICATIONS

- **Voltage:** 98-132 VAC @ 60 Hz
- **Fan:** 2 HP @ 240 VAC
- **Inducer motor:** 7 amps @ 250 VAC
- **Gas valve:** 1 amps @ 24 VAC
- **Ignitor:** 5 amps @ 120 VAC
- **Dimensions:** 5.80" x 4.50" x 1.00"

### REPLACES

- **Goodman:** B180999-06, B180999-08, B180999-10, B180999-13, B180999-13S
- **UTEC:** 1012-933D
- **Texas Instruments:** 41F-5
- **White-Rodgers:** 50T35-730, 50T35-743

## ICM281

### FEATURES/APPLICATION

- Control gas valve, ignitor, blower motor, inducer, humidifier and air cleaner
- Microprocessor-based
- Designed for 100% gas shutoff in case of ignition failure
- Model selection of 80+ and 90+ furnace operation
- Reverse polarity protection
- Secondary brownout voltage protection
- Heating and cooling fan functions in response to standard thermostat
- Provides diagnostic LEDs to aid in troubleshooting
- Twinning compatible with another **ICM281** board

### SPECIFICATIONS

- **Voltage:** 98-132 VAC @ 60 Hz
- **Operating temp.:** -40°F to 176°F (-40°C to 75°C)
- **Ignitor:** 5A @ 120 VAC
- **Cool blower:** 30A, 2HP, 240 VAC
- **Heat:** 5A, 1/2 HP, 240 VAC
- **Inducer motor:** 4A, FLA-8.0 LRA @ 120 VAC
- **Gas valve:** 1.5A @ 30 VAC
- **Dimensions:** 8.50" x 7.50" x 1.00"

### REPLACES

- **Carrier:**
  - CES0110020
  - CES0110048,
  - CES0110057-00,
  - CES0110057-01,
  - CES0110057-02,
  - HH84AA016

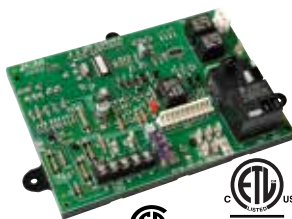
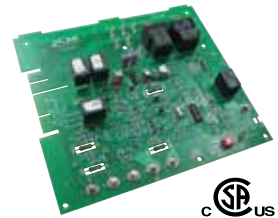

## ICM282B

### FEATURES/APPLICATION

- Control gas valve, ignitor, blower motor, inducer, humidifier and air cleaner
- Microprocessor-based
- Designed for 100% gas shutoff in case of ignition failure
- Reverse polarity protection
- Secondary brownout voltage protection
- Heating and cooling fan functions in response to standard thermostat
- Provides diagnostic LEDs to aid in troubleshooting
- Includes adapter harness (not shown)
- Twinning compatible with another **ICM282B** board

### SPECIFICATIONS

- **Voltage:** 98-132 VAC @ 60 Hz
- **Operating temp.:** -40°F to 176°F
- **Ignitor:** 5A @ 120 VAC
- **Cool blower:** 30A, 2HP, 240 VAC
- **Heat:** 5A, 1/2 HP, 240 VAC
- **Inducer motor:** 4A, FLA-8.0 LRA @ 120 VAC
- **Gas valve:** 1.5A @ 30 VAC
- **Dimensions:** 8.25" x 5.50" x 1.50"

### REPLACES

- **Carrier:**
  - HK42FZ004,
  - HK42FZ007,
  - HK42FZ008,
  - HK42FZ009,
  - HK42FZ011,
  - HK42FZ013,
  - HK42FZ016,
  - HK42FZ034,
  - 325878-751
- **ICP:** 1176943

PHONE: 1-800-365-5525 FAX: 315-233-5276 WEB: WWW.ICMCONTROLS.COM

All features and specifications are subject to change without notice.





## ICM287

### FEATURES/APPLICATION

- Microprocessor based
- Controls inducer and blower motor
- Monitors timing and gas valves

### SPECIFICATIONS

- **Line voltage:** 120 VAC @ 60 Hz
- **Voltage:** 24 VAC @ 60 Hz
- **Heat blower:** 10A, 120 VAC
- **Cool blower:** 30A, 120 VAC
- **Inducer blower:** 30A, 120 VAC
- **Dimensions:** 4.75" x 4.00" x 1.00"

### REPLACES

- **Goodman:** B18099-04

## ICM288

### FEATURES/APPLICATION

- Microprocessor-based precision
- Monitors pressure, roll-out and limit switches
- Controls gas valve, inducer draft motor, circulating blower and hot surface ignitor
- Reverse polarity detection
- Twinning compatible with another **ICM288** board
- Diagnostic LEDs to aid in testing/troubleshooting

### SPECIFICATIONS

- **Voltage:** 98-132 VAC @ 60 Hz
- **Ignitor:** 5A, 120 VAC
- **Cool blower:** 10A, 2HP, 240 VAC
- **Heat:** 5A, 1/2 HP, 250 VAC
- **Inducer blower:** 4A, 120 VAC
- **Gas valve:** 1A, 24 VAC
- **Humidifier motor:** 0.5A, 24 VAC
- **Electronic air cleaner:** 1A, 120 VAC
- **Dimensions:** 7.50" x 5.75" x 1.50"

### REPLACES

- **Rheem:**  
62-24084-82

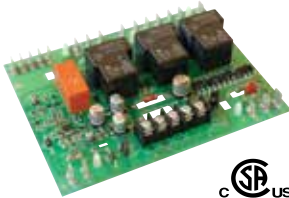

## ICM289

### FEATURES/APPLICATION

- Controls inducer fan motor, blower fan and monitors limit switches
- Microprocessor based design
- Functions with all 24 VAC thermostats

### SPECIFICATIONS

- **Voltage:** 98-132 VAC @ 60 Hz
- **Cool blower:** 20A @ 120 VAC
- **Heat blower:** 20A @ 120 VAC
- **Inducer motor:** 5A @ 120 VAC
- **Cool blower ON delay:** 1 second
- **Cool blower OFF delay:** 1 second
- **Heat blower ON delay:** 45 seconds
- **Heat blower OFF delay:** 90, 150, 210 or 270 seconds
- **Dimensions:** 5.60" x 4.25" x 1.50"

### REPLACES

- **Lennox:**  
Replaces all BCC1, BCC2 and BCC3 circuit boards, including 48K98 and 45K48.

## ICM291

### FEATURES/APPLICATION

- Direct Spark Ignition (DSI) control board
- Microprocessor-based
- Controls combustion, blower and indoor motor; spark ignitor and gas valve
- Monitors timing, trial for ignition, flame sensing and lockout
- 100% lockout safety feature
- Compatible with LP or natural gas
- Status LED for fault codes to aid in troubleshooting

### SPECIFICATIONS

- **Voltage:** 24 VAC (18-30 VAC), 60 Hz
- **Line voltage:** 208/230 VAC, 60 Hz
- **Power cons:** 0.3A plus gas valve current @ 24 VAC
- **Operating temp:** -40°C (-40°F) to 75°C (176°F)
- **Pre-purge:** 45 seconds
- **Trial for ignition:** 5+2 seconds
- **Retry period:** Every 20 seconds for 15 minutes
- **Lockout:** manual reset
- **Post-purge:** 45 seconds
- **LED indicators**
  - **Red LED:** *Steady ON* – normal operation  
*Flashing* – fault codes
- **Dimensions:** 5.00" x 7.00" x 2.25"

### REPLACES

- **Carrier:** LH33WP003/3A
- **ICP:** 1171166



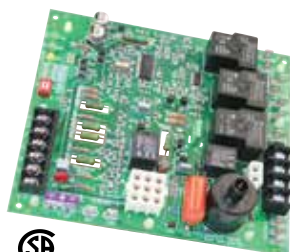

## ICM292

### FEATURES/APPLICATION

- Direct Spark Ignition (DSI) control board
- Microprocessor-based
- Controls induced draft and indoor blower motor; humidifier output, spark ignitor and gas valve
- Monitors timing, trial for ignition, flame sensing and lockout
- 100% lockout safety feature
- Compatible with LP or natural gas
- Status LEDs for fault codes to aid in troubleshooting

### SPECIFICATIONS

- **Voltage:** 24 VAC (18-30 VAC), 60 Hz
- **Line voltage:** 115 VAC, 60 Hz
- **Power cons:** 0.3A plus gas valve current @ 24 VAC
- **Operating temp:** -40°F to 176°F (-40°C to 75°C)
- **Pre-purge:** 30 seconds
- **Trial for ignition:** 7 sec.
- **Lockout:** 1 hour
- **Power:** 24 VAC and COM
- **Post-purge:** 90, 120, 160 and 180 seconds
- **Thermostat interface:** R, W, Y and G
- **Retries:** 2 groups of 2, 30 seconds delay within the group and 3 minutes delay between groups
- **System switches:** Vent pressure and limit switches (main and over-temperature switches in series)

- **LED indicators:**
  - **Power, green LED:** PWR
  - **Status, green LED:** OK
  - **Flame status, yellow LED:** FLAME
- **Dimensions:** 6.60" x 5.75" x 2.25"

### REPLACES

- **Rheem:** 62-24140-04

## ICM2801

### FEATURES/APPLICATION

- Controls vent motor, blower control, hot surface ignitor and gas valve
- Monitors timing, trial for ignition, flame sensing & lockout
- Microprocessor-based
- Reverse polarity protection
- 100% lockout safety feature
- Compatible with LP or natural gas
- Twinning compatible with another **ICM2801** control
- Status LED for fault codes to aid in troubleshooting

### SPECIFICATIONS

- **Voltage:** 98-132 VAC @ 60 Hz
- **Ignitor:** 5A, 120 VAC
- **Cool blower:** 10A, 2 HP, 240 VAC
- **Heat:** 5A, 1/2 HP, 250 VAC
- **Inducer blower:** 4A, 120 VAC
- **Gas valve:** 1A, 24 VAC
- **Dimensions:** 5.80" x 4.25" x 1.75"

### REPLACES

- **York/Evcon:** 7990-319P



## ICM2804

### FEATURES/APPLICATION

- Hot Surface Ignition (HSI) control board
- Microprocessor-based
- Controls vent motor and blower control
- Monitors limit switch, pressure switch and gas valve
- 100% lockout safety feature
- Compatible with LP or natural gas
- Status LED for fault codes to aid in troubleshooting

### SPECIFICATIONS

#### ENVIRONMENT

- **Ambient temperature**
  - **Operating:** -40°F to 176°F
  - **Storage:** -40°F to 185°F
- **Humidity:** 5% to 95% R.H. (non-condensing) @ 131°F
- **Humidity:** 13.8Hz @ 0.2 Gs for one hour in each orthogonal axis

#### ELECTRICAL

- **Voltage:** 98-132 VAC @ 60 Hz
- **Cool blower:** 20A, 2 HP, 240 VAC
- **Heat:** 10A, 240 VAC
- **Inducer motor:** 4A FLA, 8A LRA @ 120 VAC

#### TIMING

- **Inducer pre-purge time:** 1 second
- **Heat blower ON delay:** 45 seconds
- **Heat blower OFF delays:** 120 or 180 seconds
- **Cool blower ON delay:** 1 second
- **Cool blower OFF delay:** 1 second
- **Dimensions:** 6.50" x 5.00" x 1.75"

### REPLACES

- **Carrier:**
  - CES0110074-00,
  - CES0110074-01

#### Note:

*This board functions identically as the CES0110074-00 and the CES0110074-01. It is a replacement of the CES0110074-01. When replacing the CES0110074-00 some quick connectors have to be changed or added. EAC-1 and EAC-2 must have 1/4" connectors. COM, SEC-1 and SEC-2 must have 3/16" connectors.*



## ICM2805A

### FEATURES/APPLICATION

- Controls gas valve, inducer draft motor, circulating blower and hot surface ignitor
- Monitors timing, trial for ignition, flame sensing, lockout, plus pressure, roll out and limit switches
- Microprocessor-based precision
- Twinning compatible with another **ICM2805A** furnace control
- Diagnostic LEDs aid in testing and troubleshooting in troubleshooting

### SPECIFICATIONS

- **Voltage:** 98 to 132 VAC @ 60 Hz
- **Ignitor:** 5A, 120 VAC
- **Cool blower:** 10A, 2HP, 240 VAC
- **Heat:** 5A, 1/2 HP, 250 VAC
- **Inducer blower:** 4A, 120 VAC
- **Gas valve:** 1A, 24 VAC
- **Humidifier motor:** 0.5A, 24 VAC
- **Electronic air cleaner:** 1A, 120 VAC
- **Dimensions:** 6.00" x 4.50" x 1.50"

### REPLACES

- **Nordyne:**  
624631/ 624631B

## ICM2807

### FEATURES/APPLICATION

- Controls gas valve, ignitor, blower motor, inducer, humidifier and air cleaner
- Microprocessor-based precision
- Designed for 100% gas shutoff in case of ignition failure
- Twinning compatible with another **ICM2807** control
- Reverse polarity protection
- Secondary brownout voltage protection
- Compatible with 24 VAC standard thermostats
- Continuous blower speed jumper
- Provides diagnostic LEDs to aid in troubleshooting

### SPECIFICATIONS

- **Ambient temp:**
  - **Operating:** -40°F to 176°F
  - **Storage:** -40°F to 185°F
- **Ignitor:** 5A @ 120 VAC
- **Humidity:** 5% to 95% R.H. (non-condensing) @ 131°F
- **Voltage:** 98-132 VAC @ 60 Hz
- **Cool blower:** 10 HP, 120 VAC
- **Low heat:** 5A, 1/2 HP, 120 VAC
- **High heat:** 10A, 1 HP, 120 VAC
- **Inducer motor:** 4A, FLA-8.0 LRA @ 120 VAC
- **Gas valve:** 1.5A @ 30 VAC
- **EAC:** 1A@120 VAC
- **Humidifier:** 0.5A & 24 VAC
- **Dimensions:** 7.00" x 6.50" x 1.50"



### REPLACES

- **Carrier:** HK42FZ017



## ICM2808

### FEATURES/APPLICATION

- Controls gas valve, Ignitor, blower motor, Inducer, humidifier, and air cleaner.
- Microprocessor-based precision
- Designed for 100% gas shutoff in case of ignition failure
- Twinning compatible with another ICM2808 control
- Secondary brownout voltage protection
- Compatible with 24 VAC standard thermostat
- Provides dual-color diagnostic LED to aid in troubleshooting

### SPECIFICATIONS

- **Ambient temp:**
  - **Operating:** -40°F to 176°F
  - **Storage:** -40°F to 185°F
- **Voltage:** 98-132 VAC @ 60 Hz
- **Control voltage range:** 18-30 VAC @ 60 Hz
- **Humidity:** 5% to 95% R.H. (non-condensing) @ 131°F
- **Relay outputs:** Meets or exceeds O.E.M. board
- **Heat blower ON delay:** 30 seconds
- **Heat blower OFF delay:** 90-180 seconds
- **Dimensions:** 7.00" x 4.80" x 1.25"

### REPLACES

- **York:** S1-331-03010000,  
S1-331-02956000

**Note:** Does not include the bracket required on some models or the wiring harness.

## ICM2810

### FEATURES/APPLICATION

- Microprocessor-based precision
- Controls inducer and blower fan motor, hot surface ignitor, and gas valve
- Monitors timing, trial for ignition, flame sensing, pressure and limit switches, and lockout
- Designed for 100% gas shutoff in case of ignition failure
- Twinning compatible with another **ICM2810**
- Compatible with LP or natural gas
- Diagnostic LED to aid in testing/troubleshooting

### SPECIFICATIONS

- **Voltage:** 98-132 VAC @ 60Hz
- **Blower:** 10 FLA, 25 LRA @ 120 VAC
- **Inducer motor:** 2.8 FLA, 3.5 LRA @ 120 VAC
- **Ignitor:** 1.2A @ 120 VAC
- **Dimensions:** 6.00" x 4.50" x 1.00"

### REPLACES

- **Goodman:**  
PCBBF136,  
PCBBF140





## ICM2811

### FEATURES/APPLICATION

- Controls the gas valve, inducer draft motor, circulating blower and hot surface ignitor
- Monitors system pressure and limit switches
- Microprocessor based precision
- Twinning compatible with another **ICM2811** control board
- Diagnostic LEDs aid in testing and troubleshooting

### SPECIFICATIONS

- **Input voltage:** 18-30 VAC 50/60 Hz
- **Igniter current:** 6.0 amp @ 120 VAC 50/60 Hz (resistive)
- **Inducer relay:** 2.2 FLA-3.5 LRA @ 120 VAC
- **Blower relay:** 14.5 FLA-25.0 LRA @ 120 VAC (2spd-H/C)
- **Gas valve relay:** 1.5 amp @ 25 VAC 50/60 Hz 0.6 pf
- **Operating temperature:** -40°F to 176°F (-40°C to 80°C)
- **Humidity range:** 5 to 95% RH (non-condensing)
- **Dimensions:** 5.75" x 4.50" x 1.25"

### REPLACES

- **Goodman:** PCBBF110/S, PCBBF123/S, 0130F00005/S, PCBBF112/S, B18099-26/S
- **White-Rodgers:** 50A55-743, 50A55-289, 50T55-289
- **ICM:** ICM286

## ICM2812 & ICM2812-KIT

### FEATURES/APPLICATION

- Furnace control module
- Hot Surface Ignition (HSI) control board
- Microprocessor-based
- Monitors timing, trial for ignition, system switches, flame sensing and lockout and 100% lockout safety feature
- Compatible with LP or natural gas
- LED indication for status and fault codes to aid in troubleshooting
- **ICM2812-Kit** includes cable harnesses

### SPECIFICATIONS

- **Voltage:** 24 VAC (18-30 VAC)
- **Line voltage:** 120 VAC
- **Operating temperature:** -40°F to 176°F (-40°C to 80°C)
- **HSI Hot Surface Ignitor:** 6 amp @ 120 VAC
- **Gas valve:** 1.5 amp @ 24 VAC
- **Inducer draft motor:** 2.2 FLA @ 120 VAC
- **Blower motor:** 14.5 FLA @ 120 VAC
- **Humidity range:** 5 to 95% RH (non-condensing)
- **Dimensions:** 5.75" x 8.25" x 1.50"

### REPLACES

The **ICM2812** is a universal board only replacement for the White-Rodgers 50M56U-843.

The **ICM2812-KIT** includes cable harnesses that make it a replacement for more than 150 competitive part numbers.

Download the ICM Controls app for full cross reference information.

Please visit [www.icmcontrols.com/ICM2812/replacements](http://www.icmcontrols.com/ICM2812/replacements).

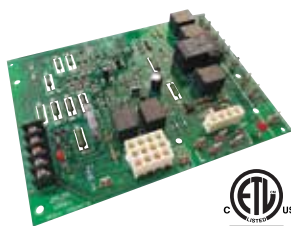

## ICM2813

### FEATURES/APPLICATION

- Controls the gas valve, inducer draft motor, circulating blower and hot surface ignitor
- Monitors system pressure and limit switches
- Microprocessor based precision
- Diagnostic LEDs aid in testing and trouble shooting

### SPECIFICATIONS

- **Input voltage:** 18-30 VAC 50/60 Hz
- **Igniter current:** 2.0 amp @ 80 VAC 50/60 Hz (resistive)
- **Inducer relay:** 2.2 FLA-3.5 LRA @ 120 VAC
- **Blower relay:** 14.5 FLA-25.0 LRA @ 120 VAC (2spd-H/C)
- **Gas valve relay:** 1.5 amp @ 25 VAC 50/60 Hz 0.6 pf
- **Operating temperature:** -40°F to 176°F (-40°C to 80°C)
- **Humidity range:** 5 to 95% RH (non-condensing)
- **Dimensions:** 5.75" x 7.50" x 1.25"

### REPLACES

- **Lennox:** 10M9301, 12L6901, 32M8801, 56L8401, 24L8501, 63K8901, 97L4801, 100925-01, 100925-03, 17W9201, 23W5101, 30W2501, 69M0801, 69M1501, 83M00
- **White-Rodgers:** 21D83M-843, 50A65-120, 50A65-121, 50A62-120, 50A62-121, 50A62-820, 50A66-122, 50A66-123

# GAS IGNITION CONTROLS



## ICM283

### FEATURES/APPLICATION

- Hot Surface Ignition (HSI) Module
- Single/dual rod sensing capabilities
- For gas fired furnaces, boilers and other heating appliances
- Switch selectable lockout times, ignition trials
- Works with both natural & LP gas systems
- Diagnostic LED to aid in troubleshooting

### SPECIFICATIONS

- **Voltage:** 120 & 24 VAC, 60 Hz
- **HSI:** 120 VAC, 5A maximum
- **Valve:** 24V, 2A maximum
- **Total:** 24V Load = 0.4 + valve load
- **Pre-purge time:** 32 seconds
- **Trial time:** 4 or 7 seconds (switch selectable)
- **Ignition trials to lockout:** 1 or 3 (switch selectable)
- **Flame sense:** Single rod or dual rod
- **Gas type:** Natural or LP
- **Dimensions:** 5.50" x 4.00" x 2.00"

### REPLACES

- **Honeywell:** S8910U-1000
- **Robertshaw:** HS780
- **White Rodgers:** 50E47, 50F47

## ICM2918

### FEATURES/APPLICATION

- Universal intermittent pilot gas ignition control
- Provides ignition sequence, flame monitoring and safety shutoff for single/dual rod intermittent pilot control applications
- For gas fired furnaces, boilers and other heating applications
- Switch selectable pre-purge and ignition trials with permanent lock
- Works with or without vent damper connected
- Works with both nNatural gas and LP gas systems

### SPECIFICATIONS

- **Voltage:** 18-30 VAC @ 50/60 Hz
- **Trial for ignition:** 15 or 90 seconds (switch)
- **Operating temp.:** -40°F (-40°C) to 165°F (74°C)
- **Relative humidity:** 5% - 95% (non-condensing) at +55°C
- **Pre-purge time:** 0 sec or 15 sec (switch settable)
- **Green status LED:** System status and error codes
- **Yellow flame LED:** Flame presence and flame strength
- **Dimensions:** 5.50" x 4.00" x 2.00"

### REPLACES

ICM290A, Honeywell S8610U & over 280 other models



See Full Replaces List Here:



## ICM2901

### FEATURES/APPLICATION

- For use with intermittent pilot boilers, furnaces and other heating appliances
- Microprocessor-based precision
- Monitors timing, trial for ignition, roll out switch, flame sensing and lockout
- Remote flame sensing
- 100% lockout safety feature
- Compatible w/ LP or natural gas

### SPECIFICATIONS

- **Voltage:** 24 VAC (18-30 VAC)
- **Frequency:** 50/60 Hz
- **Anticipator setting:** 0.3A plus valve load @ 24 VAC
- **Purge:** None
- **Trial for ignition:** 85 seconds
- **Flame failure response time:** 0.5 seconds
- **Retry:** None
- **Relative humidity:** 0% - 95% non-condensing
- **Operating temperature:**
  - Min. ambient temperature rating is -40°F (-40°C)
  - Max. ambient rating when used with 2.0A main valve is 160°F (71°C)
- **Relative humidity:** 0% to 95% non-condensing
- **Dimensions:** 5.00" x 5.75" x 2.00"

### REPLACES

- **ICM:** 294
- **Johnson Controls:** G770RJA-1
- **York:** 025-27762-700 and comparable ignition controls.

## ICM2902

### FEATURES/APPLICATION

- For use with intermittent pilot boilers, furnaces and other heating appliances
- Microprocessor-based precision
- Monitors timing, trial for ignition, flame sensing and lockout
- Remote flame sensing
- 100% lockout safety feature
- Compatible with LP or natural gas
- Status LED for fault codes to aid in troubleshooting

### SPECIFICATIONS

- **Voltage:** 24 VAC (18-30 VAC), 50/60 Hz
- **Anticipator setting:** 0.3A plus valve load @ 24 VAC
- **Purge:** 15 seconds
- **Trial for ignition:** 85 seconds
- **Lockout:** 60 minutes
- **Flame failure response time:** 2 seconds
- **Status LED:** See product label for error codes
- **Operating temperature:**
  - Min. ambient temperature rating is -40°F (-40°C)
  - Max. ambient rating when used with 2.0A main valve is 160°F (71°C)
- **Relative humidity:** 0% to 95% non-condensing
- **Dimensions:** 5.00" x 5.75" x 2.00"

### REPLACES

- **ICM:** 293
- **Johnson Controls:** G776 (63K2401, 41K8701, 69J3601) ignition controls
- **Lennox:** 30W33 ignition control,
- **Robertshaw:** 735L (18G91) or 745 (95H04) ignitor controls







## ICM2904

### FEATURES/APPLICATION

- Intermittent pilot gas ignition control module
- For use with intermittent pilot boilers, furnaces and other heating appliances
- Microprocessor-based
- Remote flame sensing
- Compatible with LP or natural gas

### SPECIFICATIONS

- **Voltage:** 18-30 VAC, 50/60 Hz
- **Pilot valve:** 2A @ 24 VAC
- **Main gas valve:** 2A @ 24 VAC
- **Current draw:** 100mA maximum
- **Pre-purge delay:** 0 seconds
- **Operating temp.:** -40°F to 167°F
- **Humidity:** 5%-95% R.H. (non-condensing) @ +55°C
- **Dimensions:** 5.50" x 4.00" x 2.00"

### REPLACES

**Reznor:** 257009  
**United TCH:** 1003-638A

## ICM2905

### FEATURES/APPLICATION

- Intermittent pilot gas ignition control module
- For use with intermittent pilot boilers, furnaces and other heating appliances
- Microprocessor-based. Monitor timing, trial for ignition, flame sensing & lockout
- Remote flame sensing
- 2 min. trial for ignition
- 60 minute lock out if pilot flame is not sensed in 2 minutes
- Compatible with LP or natural gas
- Damper control input

### SPECIFICATIONS

- **Voltage:** 18-30 VAC
- **Frequency:** 50/60 Hz
- **Humidity:** 5%-95% R.H. (non-condensing) @ +55°C
- **Operating temp.:** -40°F to 167°F
- **Pilot valve:** 2A @ 24 VAC
- **Main gas valve:** 2A @ 24 VAC
- **Current draw:** 100 mA maximum
- **Pre-purge delay:** 0 seconds
- **Trial for ignition:** 2 minutes
- **Lock out time:** 60 minutes
- **Dimensions:** 5.50" x 4.00" x 2.00"

### REPLACES

**Reznor:** 257010  
**United TCH:** 1003-514



## ICM2906

### FEATURES/APPLICATION

- Direct Spark Ignition (DSI) control board
- Cooling and heating fan outputs
- Microprocessor-based
- Controls inducer & blower motor, air cleaner (if equipped), spark ignitor & gas valve
- Monitors timing, trial for ignition, system switches, flame sensing and lockout
- Compatible with LP or natural gas
- LED indication for status and fault codes to aid in troubleshooting

### SPECIFICATIONS

- **Voltage:** 18-30 VAC
- **Frequency:** 60 Hz
- **Inducer blower type:** Relay
- **Rating:** 1/6 HP @125 VAC
- **Gas valves type:** Relay
- **Rating:** 1A @ 24 VAC
- **Heat blower type:** Relay
- **Rating:** 1/4 HP @125 VAC
- **Cool blower type:** Relay
- **Rating:** 1 HP @125 VAC
- **Operating Temp:** -40°F to 165°F
- **Dimensions:** 5.00" x 5.75" x 2.00"

### REPLACES

**Reznor:** 195573  
**United TCH:** 1097-211

## ICM2907

### FEATURES/APPLICATION

- Direct Spark Ignition (DSI) control board
- Microprocessor-based
- Controls inducer & blower motor, air cleaner (if equipped), spark ignitor & gas valve
- Monitors timing, trial for ignition, system switches, flame sensing and lockout
- Compatible with LP or natural gas
- LED indication for status and fault codes to aid in troubleshooting

### SPECIFICATIONS

- **Voltage:** 18-30 VAC
- **Frequency:** 60 Hz
- **Inducer blower type:** Relay
- **Rating:** 1/6 HP @125 VAC
- **Blower type:** Relay
- **Rating:** 1/4 HP @125 VAC
- **Gas valves type:** Relay
- **Rating:** 1A @ 24 VAC
- **Operating temp:** -40°F to 165°F
- **Dimensions:** 5.00" x 5.75" x 2.00"

### REPLACES

**Reznor:** 195265  
**United TCH:** 1097-210





## ICM2909

### FEATURES/APPLICATION

- Direct Spark Ignition (DSI) control board
- Microprocessor-based
- Monitors timing, trial for ignition, system switches, flame sensing and lockout.
- 100% lockout safety feature
- Compatible with LP or natural gas
- LED indication for status and fault codes to aid in troubleshooting

### REPLACES

- Rheem: 62-23599 (-01,-02,-03,-04,-05)

### SPECIFICATIONS

- **Inputs**
  - **Line voltage:** 208-230 VAC, 50/60 Hz
  - **Control voltage:** 18-30 VAC, 50/60 Hz
  - **System switches:** Vent pressure, limit & MRLC (Manual Reset Limit Control)
- **Outputs**
  - **Heat N.C.:** 16FLA/30 LRA @ 277 VAC, 30K @ 85°C
  - **Cool N.O.:** 15FLA/36 LRA @ 277 VAC, 100K @ 85°C
  - **Inducer:** 9.8FLA/58.8LRA, 1/2HP @ 120 VAC, 6K @ 75°C
  - **Gas valve:** 2.3 A PILOT DUTY @ 240 VAC, 6K @ 75°C
- **Fan Operation**
  - **Heat blower ON:** 1 second
  - **Heat Blower OFF:** 1 second
- **Lockout Timing**
  - **Auto reset lockout:** 60 minutes
- **Environmental**
  - **Operating temperature:** -40°F to 175°F (-40°C to 80°C)
  - **Storage temperature:** -40°F to 185°F (-40°C to 85°C)
  - **Humidity:** 5% - 95% R.H. (non-condensing) at +55°C
  - **Dimensions:** 6.60" x 5.75" x 2.25"

## ICM2910

### FEATURES/APPLICATION

- Direct Spark Ignition (DSI) control modules
- Microprocessor-based
- Controls spark ignitor and gas valve
- Monitors timing, trial for ignition, flame sensing and lockout
- Compatible with LP or natural gas
- Redundant gas valve design conforms to ANSI Z21.20
- Conforms to UL STDs 60730-1 and 60730-2-5
- Certified to CSA STD E60730-1 & CSA STD C22.2#60730-2-5

### SPECIFICATIONS

- **Voltage:** 102-138 VAC
- **Flame current:** 1uA minimum
- **Current draw:** 50mA maximum
- **Gas valve:** 1.5A@120 VAC
- **Flame failure response time:** 0.8 sec. max.
- **Operating temp:** -40°F to 175°F (-40°C to 80°C)
- **Mounting:** Surface mount using (2) #8 screws
- **Dimensions:** 5.23" x 2.53" x 1.86"



### REPLACES

ICM P/N	Replaces Fenwal P/N	# Ignition Trials	Pre-Purge Time	Inter-Purge Time	Trial for Ignition Time
ICM2910-200-005	35-725200-005	1	None	None	10S
ICM2910-201-007	35-725201-007	1	None	None	15S
ICM2910-201-501	35-725201-501	1	5S	None	4S
ICM2910-201-505	35-725201-505	1	5S	None	10S
ICM2910-205-015	35-725205-015	3	None	15S	10S
ICM2910-205-017	35-725205-017	3	None	15S	15S
ICM2910-205-021	35-725205-021	3	None	25S	4S
ICM2910-205-115	35-725205-115	3	15S	15S	10S
ICM2910-205-521	35-725205-521	3	5S	25S	4S
ICM2910-206-515	35-725206-515	3	5S	15S	10S
ICM2910-405-013*	35-725405-013	3	None	15S	7S

\* Open board design



## ICM2911

### FEATURES/APPLICATION

- Direct Spark Ignition (DSI) control board
- Microprocessor-based
- Monitors system timing, trial for ignition, system switches, flame sensing and lockout
- 100% lockout safety feature monitors for repeated over-temperature faults or flame losses and disables the heat operation for safety
- Continuously monitors the gas valve output
- Compatible with LP or natural gas
- LED indication for status and fault codes to aid in troubleshooting
- Twinning feature allows two furnace boards to be controlled with a single thermostat
- Field test mode

### REPLACES

- **Modine Spark Ignition Control:** 5H79749

### SPECIFICATIONS

- **Inputs**
  - **Line voltage:** 120 VAC, 50/60 Hz
  - **Control voltage:** 18-30 VAC, 50/60 Hz
- **Outputs**
  - **Spark ignition:** 12kV O.C.V., 60Hz
  - **Heat blower:** 15 FLA/30 LRA @ 277 VAC
  - **Inducer fan:** ½ HP, 9.8FLA/58.8LRA @120 VAC
  - **Gas valve:** 2.3A Pilot Duty @ 240 VAC
- **Environmental**
  - **Operating temperature:** -40°F to 175°F (-40°C to 80°C)
  - **Dimensions:** 6.50" x 5.25" x 3.00"

# OIL BURNER PRIMARIES

## ICM1500 SERIES: ICM1501, ICM1502 & ICM1503



### FEATURES/APPLICATION

- Controls oil burner, oil valve (if desired) and the ignition transformer in response to a call for heat
- Solid state flame sensing circuit
- LED on terminal strip indicates system lockout
- Enclosed safety switch with external reset button
- C554A Cadmium Sulfide flame detector required
- Form, fit and functional replacement for popular competitive models

### SPECIFICATIONS

- **Ignition type:** Intermittent
- **Timing, safety switch:** 15, 30 or 45 seconds
- **Mounting bracket:** For mounting on a standard 4" X 4" junction box or direct mounting on burner housing
- **Temperature range:** -30°F to +130°F
- **Approvals:** Underwriters Laboratories Inc.
- **Dimensions:** 4.10" x 2.36" x 4.40"

### REPLACES

ICM P/N	Safety Timing	Replaces
ICM1501	15 Seconds	Honeywell: R8184G4066, R8184G1161, R8184G1294
ICM1502	30 Seconds	Honeywell: R8184G4074, R8184G1179, R8184G1302, R8184G4033
ICM1503	45 Seconds	Carlin: 48245 Honeywell: R8184G4009, R8184G1138, R8184G1427, R8184G4025 Tempstar/Heil: 1147017 White Rodgers: 668-401

# DEFROST CONTROLS

## IDEAL FOR DEFROST APPLICATIONS

### ICM300



### FEATURES/APPLICATION

- Replacement for OEM Type 621
- Low cost, time and temperature defrost
- HOLD input tracks compressor run times
- Time and temperature terminate
- Test pins reduce test time by 256x
- Stable pin post construction

### SPECIFICATIONS

- **Voltage:** 18-30 VAC
- **Frequency:** 50/60 Hz
- **Output:**
  - **Type:** Relay, SPST
  - **N.O.:** 1 amp @ 30 VAC
- **Defrost time:** 10-minute fixed
- **Interval times:** Pin-selection 30/60/90 min.
- **Dimensions:** 3.50" x 1.00" x 2.75"

### REPLACES

- **Amana:** C64301-1, C64310-1
- **Arcoaire:** 32312-00, 3232140
- **Artesian:** 10321-00
- **Coleman:** 3030A374
- **Essex:** 621-1 to 621-11, 621-310
- **Goodman:** B12260-06
- **Heil Quaker:** HQ1052757
- **Honeywell:** ST74A1004, ST74A1020, ST74A1038
- **ICP:** 1052757 • **Intertherm:** 6208800
- **Lennox:** 33G9501 • **Rheem:** 47-21776-01
- **Robertshaw/Uni-Line:** TD-10, DT2-1000
- **Snyder General:** 1395-329 • **Steveco:** 90-621
- **Therm-O-Disc:** 26E-10
- **Weatherking (Addison):** 840-4-5548
- **White-Rodgers:** 90-621

## FORM, FIT AND FUNCTIONAL OEM REPLACEMENT PARTS



### ICM314

### FEATURES/APPLICATION

- Time and temperature terminated defrost
- Integral short cycle protection
- High/low pressure switch monitoring
- High power condenser fan relay output
- Strip heat & reversing valve outputs
- Anti-bang feature when entering and exiting defrost mode

### SPECIFICATIONS

- **Voltage:** 18-30 VAC
- **Frequency:** 50/60 Hz
- **Power:** 4.8 VA maximum (200 mA at 24 VAC)
- **Anti-short cycle delay:** 3 minutes
- **Defrost time:** Fixed at 12 minutes
- **Output: O-RV Type:** Relay **Rating:** 1 amp @ 30 VAC
- **CNT: Type:** Relay **Rating:** 1 amp @ 24 VAC
- **OFM: Type:** Relay **Form:** SPST N.C. **Rating:** 15 amps @ 240 VAC
- **Interval times:** Pin-selectable 30/60/90 min.
- **Dimensions:** 2.90" x 3.50" x 2.00"

### REPLACES

- **Goodman:** PCBDM133, PCBDM133S





## ICM315

### FEATURES/APPLICATION

- Reliable thermistor-type sensor is less susceptible to breakage, easier to mount
- Replaces faulty bulb-type sensors
- Test pins reduce test time by 256x
- Stable pin post construction
- Time and temperature terminate

### SPECIFICATIONS

- **Voltage:** 24, 120, 240 VAC
- **Frequency:** 50/60 Hz
- **Defrost time:** 10-minute fixed
- **Output: Type:** Relay, SPDT **N.O.:** 20 amps **N.C.:** 10 amps
- **Interval times:** Pin-selectable 30/45/90 min.
- **Dimensions:** 4.20" x 4.20" x 1.20"

### REPLACES

- **Avion:** DFT100
- **Ranco:** E-15

## ICM318

### FEATURES/APPLICATION

- Low cost, time and temperature defrost
- Time and temperature terminate
- Test pins reduce test time by 256x
- HOLD input tracks compressor run times

### SPECIFICATIONS

- **Voltage:** 18-30 VAC
- **Frequency:** 50/60 Hz
- **Outdoor fan relay output:** 1/2 HP fan @ 240 VAC
- **Strip heat, reversing valve outputs:** 1 amp @ 30 VAC
- **High power output:** 1/2 HP fan @ 240 VAC
- **Defrost time:** 10-minute fixed
- **Interval times:** Pin-selectable 30/60/80 min.
- **Dimensions:** 3.75" x 3.25" x 1.25"

### REPLACES

- **Goodman:** B1226008
- **ICM:** W1001-4

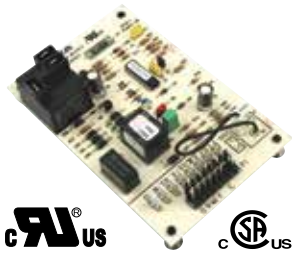

## ICM321

### FEATURES/APPLICATION

- Low cost, time and temperature defrost
- Time and temperature terminate
- Test pins reduce test time by 256x
- High power output, outdoor fan (1/2 HP fan @ 240 VAC)
- Integral short cycle protection

### SPECIFICATIONS

- **Voltage:** 18-30 VAC
- **Frequency:** 50/60 Hz
- **Outdoor fan relay output:** N.O.: 20 amps **N.C.:** 10 amps
- **Strip heat, reversing valve outputs:** 1 amp @ 30 VAC
- **Form:** SPDT
- **Anti-short cycle time:** 5 minutes
- **Defrost time:** 10-minute fixed
- **Interval times:** Pin-selectable 30/50/90 min.
- **Dimensions:** 5.50" x 3.50" x 1.60"

### REPLACES

- **Carrier:** CES0110063-00, CES0110063-01, CES0110063-02, CES0110063-02A, CES0130024-01, 150-83-6A
- **ICP:** 1171803, 1173425

## ICM324

### FEATURES/APPLICATION

- Time and temperature terminate
- 3 or 5 minute selectable ASC delay
- Pin selectable defrost intervals: 30/60/90 minutes
- 10 minute fixed defrost time
- High/low pressure switch monitoring
- Strip heat and reversing valve outputs
- Test pins reduce test time by 256x

### SPECIFICATIONS

- **Voltage:** 18-30 VAC
- **Frequency:** 50-60 Hz
- **Power consumption:** 1 watt max.
- **CC, Aux. Heat, RVS**
  - Type: Relay
  - Form: SPST, N.O.
  - Rating: 2 amps @ 24 VAC
- **IDF, ODF**
  - Type: Relay
  - Form: SPST, N.C.
  - Rating: 10 amps @ 240 VAC
- **Dimensions:** 5.80" x 4.25" x 1.25"

### REPLACES

- **Goodman:** PCBDM 133 (Direct replacement)

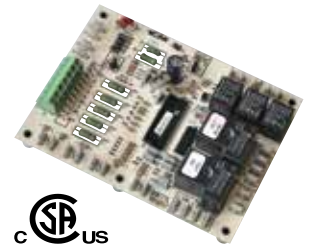

## ICM350

### FEATURES/APPLICATION

- Adjustable 30, 60, 90, & 120 minute timing sequences
- Speedup jumper for quicker testing and troubleshooting
- Microcontroller precision timing
- Time and temperature termination
- Quiet Shift: Reduces noise disturbance when entering & exiting the defrost sequence
- 5 minute anti-short cycle delay
- Optional random start timer

### SPECIFICATIONS

- **Voltage:** 18-30 VAC
- **Frequency:** 50/60 Hz
- **Power consumption:** 1 watt max.
- **Current draw:** 300 mA maximum
- **Max. defrost sequence:** 10 minutes
- **Dimensions:** 5.50" x 3.50" x 1.25"

### REPLACES

- **Carrier:** HK32EA001, HK32EA003, HK32EA008
- **ICP:** 1173636



UL US  
LISTED  
E492643  
CLOCK OPERATED SWITCH

## ICM550

### FEATURES

- 24-hour multi-functional timer
- Timed or manual termination
- Adjustable 15 min to 23 hours 45 min defrost cycle
- High power relay outputs
- 100% monitoring of inputs and outputs
- Simple to use, drag & drop replacement for popular models
- User-friendly time clock
- Order: **ICM550**

### SPECIFICATIONS

#### ELECTRICAL RATING

- **Voltage:** 120-240VAC
- **Frequency:** 60 Hz

#### OUTPUT

- **Type:** Relay
- **Form:** SPDT, SPST
- **Rating:**
  - [2] & [4]: 30A R, 1HP @ 120 VAC, 2HP @ 240 VAC
  - [1] & [3]: 40A R, 1HP @ 120 VAC, 2HP @ 240 VAC
  - [1] & [F]: 30A R, 1HP @ 120 VAC, 2HP @ 240 VAC

#### TIMING

- **Minimum cycle time:** 15 min
- **Maximum cycle time:** 23 hr 45 min
- **Terminate cycle:** Cycle can be terminated by shorting "X to N"

#### STATUS LED

- **Cycle mode:** (Red LED)
- **Normal mode:** (Green LED)

#### DIMENSIONS

- **ICM550:** 4.50" x 3.12" x 6.00"
- **ICM550-ENC:** 8.75" x 6.50" x 2.75"

#### REPLACES

- **Intermatic/Grasslin:** 010-0011B, DT040, DT140, DTAV40, DTAV40M, DT-B, DTMV, DTSX
- **Paragon:** 8041, 8045, 8047, 8141, 8143, 8145, 8245, 8247
- **Precision:** 6041, 6045, 6047, 6141, 6145



UL US  
LISTED  
E492643  
CLOCK OPERATED SWITCH

## ICM550-ENC

### FEATURES

- Enclosed 24-hour multi-functional timer
- Timed or manual termination
- Adj. 15 min to 23 hours 45 min defrost cycle
- High power relay outputs
- 100% monitoring of inputs and outputs
- Simple to use, drag & drop replacement for popular models
- User-friendly time clock
- Enclosure not sold separately
- Weatherproof Enclosure Ratings
- Rugged, NEMA/TYPE 4X rated plastic, weatherproof enclosure
- Easy to mount and lockable
- Helps to protect controls from harsh environmental conditions such as temperature, shock, humidity and vibration
- Order: **ICM550-ENC**

## DEMAND DEFROST CONTROL

## ICM3000

### FEATURES/APPLICATION

- Heat active (B) reversing valve logic
- Sensor input for defrost terminate
- Time and temperature terminate
- 14-minute fixed defrost time
- On-board test pins
- Input accumulates actual compressor run time
- Pin-selectable: 50°F, 60°F, 70°F (factory default), 80°F defrost terminate
- Integral short cycle protection
- Certified to UL 60730-1 and CSA E60730-1:15

### SPECIFICATIONS

#### INPUT

- **Voltage:** 18-30 VAC, 50/60Hz
- **OAT (outdoor ambient sensor):** 10kΩ @ 77°F
- **OCT (outdoor coil sensor):** 10kΩ @ 77°F

#### OUTPUT

- **CC (compressor contactor):** 1A, 24 VAC, pilot duty
- **RV (reversing valve):** 1A, 24 VAC, pilot duty
- **D (auxiliary heat):** 1A, 24 VAC, pilot duty
- **Fan (outdoor fan):** 2 FLA, 4 LRA, 120 VAC / 240 VAC

#### TIME DELAY

- **Defrost:** Fixed at 14 minutes
- **Delay on make:** 3 minutes
- **Anti-short cycle delay:** 3 minutes
- **LPC (low pressure cutoff):**
  - Bypassed during the defrost cycle
  - Bypassed for the first 90 seconds of compressor run time
  - Bypassed for 90 seconds after the defrost cycle
- **Operating temperature range:** -22°F to 158°F (-30°C to 70°C)
- **Storage temperature range:** -40°F to 185°F (-40°C to 85°C)
- **Dimensions:** 5.50" x 3.50" x 1.25

### REPLACES

- **Rheem:**
  - 1157-100,
  - 1157-110,
  - 1157-120,
  - 1157-121,
  - 47-102684-01,
  - 47-102684-02,
  - 47-102684-03,
  - 47-102684-04,
  - 47-102684-08,
  - 47-102685-02,
  - 47-102685-04,
  - 47-102685-05,
  - 47-102685-06,
  - 47-102685-07,
  - 47-21517-22,
  - DDL-122131-2RH
- **White Rodgers:**
  - 47D43-101-90,
  - 47D43-111-01,
  - 47D43-111-02,
  - 47D43-111-03,
  - 47D43-111-04,
  - 47D43-811



UL US  
E118867

# INCREASE REFRIGERANT SYSTEM EFFICIENCY BY EVADING MASSIVE ICE BLANKETS ON EVAPORATOR COILS!

The ICM550 reduces the need for excess defrost cycles in refrigerating applications, specifically applicable to walk-in coolers/ commercial freezers.

**Why does this matter?** The increased efficiency presents the opportunity for a decrease in utility costs.

An elegant, simple to use, drag & drop replacement for popular defrost timers, the ICM550 is a bare board solution with the simple, user-friendly time clock for commercial refrigerant cooler applications.

To order with the weatherproof enclosure, use part number ICM550-ENC.



**UL** US  
LISTED  
E492643  
CLOCK OPERATED SWITCH

**ICM550-ENC**  
With NEMA Type 4X  
Rated Weatherproof  
Enclosure

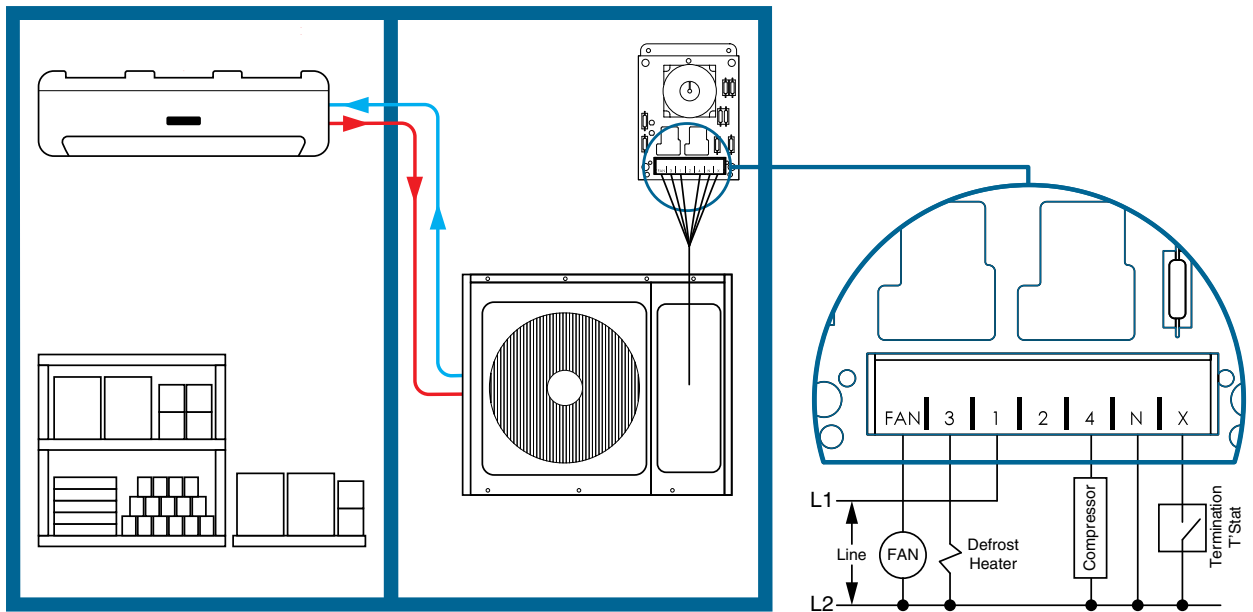

# HEAD PRESSURE CONTROLS

## ICM325HN (120-480 VAC) & ICM325HNV (600 VAC)



### FEATURES/APPLICATION

- Integral heat pump bypass circuitry allows electronic bypass of speed control
- Eliminates overshoots common to on/off and pressure switch controls
- Helps prevent evaporator freeze-ups, low pressure cut outs and liquid-slugged compressors in low ambient conditions
- Hard start, low temperature cutoff, isolated 24 VAC supply
- Controls up to 3 refrigerant circuits
- Typical application: A/C and heat pumps

### SPECIFICATIONS

- **Input:**
  - **Control:** 18-30 VAC
  - **Frequency:** 50/60 Hz, 1.8 VA max.
  - **Line input:**
    - (ICM325HN) 120-480 VAC
    - (ICM325HNV) 600 VAC
- **Output:**
  - **Maximum:** 10 amps
  - **Minimum:** 100 mA
- **Modulation:** 70°F to 100°F
- **Dimensions:** 4.50" x 3.00" x 1.75"

### REPLACES

- **ACT:** FM2000
- **Hoffman:** 800, 800A, 800AA, 814-50, 816-10
- **Ranco:** E31Series

## ICM326HN (120 OR 208/240 VAC)

### FEATURES/APPLICATION

- Integral heat pump bypass circuitry allows electronic bypass of speed control
- Built in transformer eliminates cost, reduces installation time and simplifies wiring
- Helps prevent evaporator freeze-ups, low pressure cut outs and liquid-slugged compressors in low ambient conditions
- Hard start, low temperature cutoff
- Ideal for line voltage air conditioning & refrigeration
- For line voltage reversing valves only

### SPECIFICATIONS

- **Input:**
  - **Control:** 120 or 208/240 VAC
  - **Frequency:** 50/60 Hz
- **Output:**
  - **Maximum:** 10 amps
  - **Minimum:** 100 mA
- **Modulation:** 70°F to 100°F
- **Dimensions:** 4.50" x 3.0" x 2.0"

### REPLACES

- **ACT:** FM4000
- **Hoffman:** 800, 800A, 800AA, 814-50, 816-10
- **Ranco:** E31 Series



## ICM327HN (480 VAC)

### FEATURES/APPLICATION

- Integral heat pump bypass circuitry allows electronic bypass of speed control
- Built in transformer eliminates cost, reduces installation time and simplifies wiring
- Helps prevent evaporator freeze-ups, low pressure cut outs and liquid-slugged compressors in low ambient conditions
- Hard start, low temperature cutoff
- Ideal for line voltage air conditioning & refrigeration
- For line voltage reversing valves only

### SPECIFICATIONS

- **Input:**
  - **Control:** 480 VAC
  - **Frequency:** 50/60 Hz
- **Output:**
  - **Maximum:** 10 amps
  - **Minimum:** 100 mA
- **Modulation:** 70°F to 100°F
- **Dimensions:** 4.50" x 3.0" x 2.0"

### REPLACES

- **ACT:** FM4000
- **Hoffman:** 800, 800A, 800AA, 814-50, 816-10
- **Ranco:** E31 Series

## ICM333 (120-600 VAC)

### FEATURES/APPLICATION

- Support for dual temperature OR dual pressure probes
- 120-600 VAC
- Integral heat pump bypass circuitry allows for electronic bypass of speed control
- Dial temperature or pressure set point: 70°F to 140°F, 35-465 psig
- Helps prevent evaporator freeze-ups, low pressure cut outs and liquid slugged compressors in low ambient conditions
- Hard start, low temperature cutoff

### SPECIFICATIONS

- **Voltage:** 18-30 VAC
- **Line voltage:** 120, 208, 240, 277, 480 and 600 VAC
- **Frequency:** 50/60 Hz
- **Operating temperature:** -40°F to +176°F
- **Probes:**
  - **Temperature:** Thermistor, 10K ohm at 77°F
  - **Pressure:** ICM380 (ordered separately)
- **Heat pump override:** 24 VAC, N.C./N.O.
- **Mounting:** Surface mount using (2) #8 screws
- **Dimensions:** 4.75" x 3.25" x 2.00"

### REPLACES

- **Johnson Controls:** P66AAB/ P66AAD





## ICM334 (208-600 VAC)

### FEATURES/APPLICATION

- 3-phase ON/OFF control
- One temperature and two pressure inputs
- Integral heat pump bypass circuitry
- Solid 10 amp load carrying capability
- Hard Start – 10 second hard start
- 120-600 VAC
- Heat pump bypass
- Applies full voltage to the motor under normal conditions

### SPECIFICATIONS

- **Voltage:** 18-30 VAC
- **Line voltage:** 120-600 VAC
- **Frequency:** 50/60 Hz
- **Operating temp.:** -40°F to +140°F
- **Probes:**
  - **Temperature:** ICM379 thermistor, 10K ohm at 77°F
  - **Pressure:** ICM380 (ordered separately)
- **Heat pump override:** 24 VAC, N.C./N.O.
- **Mounting:** Surface mount using (2) #8 screws
- **Dimensions:** 4.75" x 3.25" x 2.00"

## CONTROL ACCESSORIES

### ACC-OE-03 (OUTDOOR ENCLOSURE)

#### FEATURES/APPLICATION

- Rugged steel construction
- Easy to mount
- Helps to protect controls from harsh environmental conditions such as temperature, shock, humidity and vibration
- Ideal for use with ICM head pressure controls

#### SPECIFICATIONS

- NEMA 3R rated
- **Dimensions:** 4.25" x 6.25" x 6.25"



### ICM379 PROBE

#### FEATURES/APPLICATION

- Probe for use with **ALL** head pressure controls with optional heat pump bypass feature

#### SPECIFICATIONS

- 70°F to 100°F (21°C to 38°C)
- **Dimensions:** 79.0" x 0.12" x 0.75"

### ICM380

#### FEATURES/APPLICATION

- Optional pressure transducer for **ICM333** & **ICM334** head pressure controls

#### SPECIFICATIONS

- **Length:** 72"
- 0-500 psi
- 1/4" SAE female flare with Schraeder deflator
- **Dimensions:** 39.0" x 2.00" x 0.75"





# Thermostats

- Programmable
- Non-programmable
- Wi-Fi
- A model for every situation
- Large displays
- Simple installation
- Available with a custom logo



ICM Controls has been producing a wide range of thermostats for 20+ years

# THERMOSTAT QUICK REFERENCE GUIDE



## i3™ Series – Wi-Fi Thermostat

i2020WR: 2H/2C, 7-day programmable, HW

## Simple Comfort® Non-Programmable Thermostats

### Heat Only Thermostats

**SC1600L:** 1-stage heat, battery, no fan output

**SC1600VL:** 1-stage heat, battery, no fan output, verical model

### Heat/Cool Thermostats

**SC2010L:** 1H/1C, backlit display, dual powered



## Simple Comfort® Programmable Thermostats

### Heat/Cool Thermostats

**SC5010:** 1H/1C, auto changeover, dual powered, PRO series

### Multi-Stage Thermostats

**SC5811:** 2H/2C, auto changeover, HW, PRO series

## Garage – Frost Sentry™

**FS1500L:** Frost Sentry™, 35°F-75°F, heat only, battery powered



## Temporary Construction

**ACHo45:** Cool only, 45°F fixed

**ACHo55:** Cool only, 55°F fixed

**ACHo60:** Heat only, 60°F fixed

**ACHo65:** Heat only, 65°F fixed

**ACHo70:** Heat only, 70°F fixed

**ACHo75:** Cool only, 75°F fixed

**ACHo85:** Cool only, 85°F fixed

## Accessories

**ACC-RT103:** Remote sensor for SC5811

**ACC-RT104:** Remote sensor for FS1500L, SC1600L/VL and SC5010 thermostats

**ACC-WP03:** Large, universal insulated wall plate

**ACC-WP04:** Small, universal insulated wall plate



# I3™ THERMOSTATS

## Through innovation, comes affordability!

Designed around capacitive touch sensing technology, the new and innovative i3™ Series Touch Thermostat from ICM Controls feature huge displays and a patent-pending dynamic interface for intuitive programming that uses familiar icons that illuminate only when they are needed.



P/N	PROGRAM	STAGES	HP	POWER	WI-FI	HUMIDITY	TERMINATIONS
i2020WR	7-Day	2H/2C	Y	Hardwired	Y	N	RC, RH, C, W1/O/B, W2, Y1, Y2, G, S1, S2, SC

### FEATURES:

- **Alexa 5.0 Compatible** – The Wi-Fi i3 is compatible and can communicate with your Alexa!
- **Large Display** – The touch icons are positioned away from the display for a larger viewing area; keeps display clean
- **Button/Switch Free Front** – No mechanical buttons or switches to break or wear
- **Dynamic Interface** – Highly intuitive – patent-pending! Icons illuminate ONLY when they are needed
- **Customized Printed Interface** – Color and plastic can be customized
- **Customized Icons** – Uses branded icons, or those found on most cell phones, in any desired backlit color
- **Positioning** – Thin profile ideal for either “internal” or “wall mount” applications
- **Mounting Base** – Designed with sub base to make installation a “snap”
- **Removable Logo Plate** – Great for customers to promote their business
- **Thermal Safety** – Excessive heating bi-metal safety switch
- **User Coded Lockout** – Designed with renters and children in mind

### TYPICAL APPLICATIONS:

- Temperature controls in residential and commercial buildings
- Appliances such as heating, air conditioning, and refrigeration equipment including commercial freezers

### DIMENSIONS

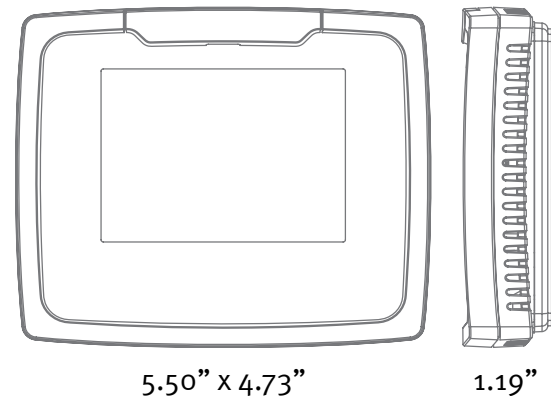

### SPECIFICATIONS:

- 6 (1A) relay outputs
- 7-Day, 5-2-Day, or 5-1-1 day programmable
- Configurable for multiple systems
- Large display with backlight
- Selectable Celsius or Fahrenheit
- Icon indicator lights
- Relay outputs – minimum voltage drop in thermostat
- Remote sensor compatible
- Ideally suited for:
  - Residential (new construction/replacement)
  - Light commercial
- Works with two-transformer systems

### CUSTOMIZE YOUR I3™ THERMOSTAT!

- Add your company name and/or phone number to the removable tab on top of the thermostat or leave it blank.
- Logo is laser engraved directly into the tab so it will never fade, wash off, rub off or peel off. Logo will be 50% grey.
- **Maximum custom logo area is 1.75" wide x .25" high**

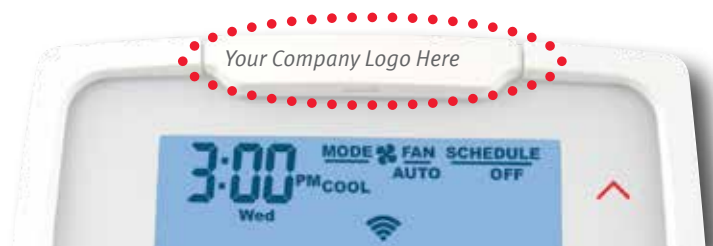

# SIMPLECOMFORT® THERMOSTATS

## SimpleComfort® Thermostat Features

Thermostat Model Number		Exclusive Patented Thermal Intrusion Barrier	1-Stage	2-Stage	3-Stage Heat	Heat Pump	Heat - gas/oil	Cool	Battery	Hard Wired	Auto Changeover - soft switch	Dual Fuel	Backlit	Remote Sensor	Permanent Memory	Field Temperature Calibration	Maximum Heat Set point	Minimum Cool Set point	Adj. Temperature Differential for Each Stage	Freeze Protection	High Temperature Protection	Programmable Fan	Temporary Override	Keypad Lockout	Millivolt Compatible	4 or 5 wire	Status LEDs	Comfort/Energy Savings Mode	Vertical Model Available
Non Programmable	SC1600L	●	●				●		●				●	●					●	●	●				●			●	
	SC1600VL	●	●				●		●				●	●						●	●	●				●			●
Programmable	SC2010L	●	●			●	●	●	●	●			●	●	●	●	●	●	●	●	●	●		●		●			
	SC5010	●	●			●	●	●	●	●	●		●	●	●	●	●	●	●	●	●	●	●	●		●	●		
Programmable	SC5811	●		●		●	●	●			●		●	●	●	●	●	●	●			●	●	●		●	●	●	
	SC5811	●		●		●	●	●			●		●	●	●	●	●	●	●			●	●	●		●	●	●	

## FAN COIL RELAY CONTROL BOARDS



### SC1600L, SC1600VL

#### FEATURES/APPLICATION

- Single-stage heat thermostat
- ICM patented thermal intrusion barrier
- Large backlit LCD display
- Battery operated with low battery indicator
- Millivolt compatible
- Freeze protection feature
- Remote sensor compatible
- Compatible with gas, oil and hydronic systems
- Selectable °F and °C
- For vertical model, order: **SC1600VL**

#### SPECIFICATIONS

- **Electrical rating:**
  - 24 VAC (18-30 VAC)
  - 1 amp maximum per terminal
- **Temperature control ranges:** 45°F to 90°F, Accuracy ± 1°F

#### TERMINATIONS

R, W, S1, S2

### SC2010L

#### FEATURES/APPLICATION

- For single-stage heat/cool or single-stage heat pump
- ICM patented thermal intrusion barrier
- Large display with backlight
- Adjustable temperature differential
- Easy access terminal block
- Field adjustable calibration
- 4- or 5-wire compatible
- Dual powered
- Manual changeover
- Permanent memory
- Freeze protection
- Selectable °F and °C
- Keypad lockout

#### SPECIFICATIONS

- **Electrical rating:**
  - 24 VAC (18-30 VAC)
  - 1 amp max. per terminal
- **Temperature control ranges:** 45°F to 90°F, Accuracy ± 1°F

#### TERMINATIONS

RC, RH, C, W, Y, O, B, G



## SIMPLECOMFORT® PRO PROGRAMMABLE THERMOSTATS



### SC5010 PRO

#### FEATURES/APPLICATION

- For single-stage heat/cool or single-stage heat pump
- 7-day, 5-2-day and 5-1-1-day programming
- ICM patented thermal intrusion barrier
- Manual or auto changeover
- Large display with backlight
- Permanent memory
- Dual powered (battery or hardwire)

#### SPECIFICATIONS

- **Electrical rating:**
  - 24 VAC (18-30 VAC)
  - 1 amp max. per terminal
- **Easy access terminal block**
- **Temperature control ranges:**  
45°F to 90°F, Accuracy  $\pm 1^\circ\text{F}$

#### TERMINATIONS

RC, RH, C, W/O/B,  
Y, G, S1, S2

### SC5811 PRO

#### FEATURES/APPLICATION

- For two-stage heat/cool or two-stage heat pump
- 7-day, 5-2-day and 5-1-1-day programming
- Hardwired
- ICM patented thermal intrusion barrier
- Large backlit LCD display
- Auto or manual changeover
- Adjustable temperature differential for each stage
- Permanent memory

#### SPECIFICATIONS

- **Electrical rating:**
  - 24 VAC (18-30 VAC)
  - 1 amp max. per terminal
- **Easy access terminal block**
- **Temperature control ranges:**  
45°F to 90°F, Accuracy  $\pm 1^\circ\text{F}$

#### TERMINATIONS

R, C, W1/O/B, Y1,  
W2, Y2, G, S1, S2



## FROST SENTRY™ GARAGE THERMOSTATS

*When it comes to freezing cold temperatures, you can relax knowing that ICM's Frost Sentry™ is on guard. These low-cost thermostats are perfect for areas where protection from extreme cold is essential. Its special foam backing improves accuracy by providing separation from the wall at installation, while sealing up any unsightly wiring holes. This insulated backing helps eliminate the risk of "wall effect" (wall temperature causing false temperature readings). Ideal for storage areas, garages, workshops, crawl spaces and other critical areas.*



### FS1500L

#### FEATURES/APPLICATION

- Controls single stage heating systems
- Millivolt, hydronic (water or steam) system, gas and electric systems
- Battery operated
- Backlit display
- Mercury-free, environmentally safe
- Remote sensor compatible ACC-RT104
- Perfect for use with unit heaters

#### SPECIFICATIONS

- **Electrical rating:**
  - 24 VAC (18-30 VAC)
  - 1 amp maximum per terminal
  - Easy access terminal block
- **Temperature control ranges:**  
35°F to 75°F, Accuracy  $\pm 1^\circ\text{F}$

#### TERMINATIONS

R, W, G, S1, S2

# SIMPLECOMFORT® THERMOSTATS ACCESSORIES

## REMOTE SENSOR

**Need to monitor the temperature away from the thermostat?**

*Choose an ICM remote sensor.*

The fast, easy solution for temperature sensing problems.

- For tamper-prone areas
- Poor air flow areas
- Troubled applications
- Foam gasket prevents drafts through wall opening
- Mounts to standard 2" x 4" outlet box
- **Order: ACC-RT103** – 2 3/4" x 4 1/2" **ACC-RT104** – 2 3/4" x 4 1/2"



*Remote Sensor Compatible with the Following Thermostats*

ACC-RT103	ACC-RT104		
SC5811	SC1600L/VL	SC5010	FS1500L i3 SERIES

## WALL PLATES

**Need more wall coverage?**

*Choose an ICM insulated wall plate.*



The fast, easy solution for hiding wall problems.

- Rugged, flexible construction
- Foam gasket prevents drafts through wall opening
- Hidden mounting screws (included) for a sleek appearance

**Order: ACC-WP03** – 5 19/32" x 7 1/2" **ACC-WP04** – 5 27/32" x 5 15/16"

ACC-WP03



ACC-WP04



# DRYOUT / NEW CONSTRUCTION THERMOSTATS

The ACHo45 to ACHo85 series thermostats are low-cost, single set point thermostats intended for use as temporary devices to provide heating or cooling to allow drywall to dry during construction. They also can be used as a low ambient cutoff switch.

## FEATURES

- Two-wire installation
- Seven fixed set point models to choose from: 45°F to 85°F
- Temporary use for dryout applications
- Can be used as a low ambient cutoff switch

## SPECIFICATIONS

- **Input:** 18-30 VAC
- **Output:** 2 amp maximum
- **Temperature control range:** 45°F to 85°F (±9°F)



## MODES OF OPERATION

### • Heat/Cool Thermostat

The heating models will close when the ambient temperature drops below the respective set point and open when the ambient temperature is above the respective set point. The cooling models will close when the ambient temperature is above the respective set point and open when the ambient temperature drops below the respective set point.

### • Low Ambient Cutoff: Condenser Fan Motor

The ACHo45 and ACHo55 models can be used as a low ambient cutoff switch for a condenser fan motor. When the ambient temperature drops below the set point, the unit will open the fan signal and turn the fan motor off. It will not allow the fan to turn back on until the temperature rises above the set point.

### • Low Ambient Cutoff: Compressor

The ACHo45 and ACHo55 models can also be used as a low ambient cutoff switch for the compressor when wired in series with the Y circuit from the thermostat. When using with the compressor circuit, an anti-short cycle timer is recommended to prevent possible damage to the compressor from short cycling.

## ORDERING INFORMATION

Part Number	ACHo45	ACHo55	ACHo60	ACHo65	ACHo70	ACHo75	ACHo85
Temperature Range*	45°F ±9°	55°F ±9°	60°F ±9°	65°F ±9°	70°F ±9°	75°F ±9°	85°F ±9°
2-Wire	✓	✓	✓	✓	✓	✓	✓
Heat			✓	✓	✓		
Cool	✓	✓				✓	✓

\* Consult factory for other set points

## WIRING DIAGRAMS

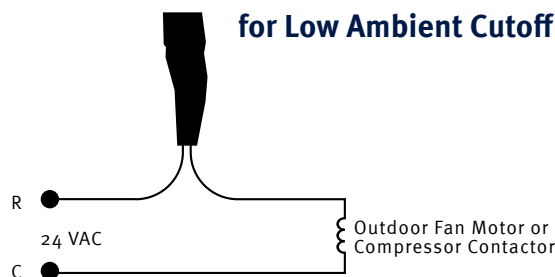
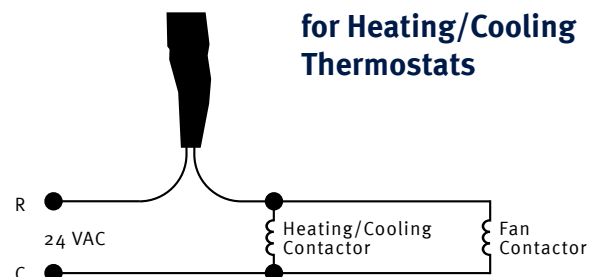

# CUSTOM LOGO PROGRAM INSTRUCTIONS

## Simple Comfort® & i3™ Series Logo Ordering Instructions



### 1. Please read entire Custom Logo Request Form prior to completing it.

- If you do not understand something, contact Jim Kocik @ 800.365.5525 x321.
- ANY modifications to a previously approved logo requires that this Custom Logo Request Form is resubmitted.

### 2. Completely fill out the Custom Logo Request Form, and send it to ICM.

- Print appropriate information in the blank spaces on the form.
- Pay special attention to check boxes.

**IMPORTANT!** Please do not send in a PO with this Custom Logo Request Form. A PO for Custom Logo Requests cannot be processed until a Logo L#### is assigned & the logo approved. This L#### must be used on the PO when ordering! The Custom Logo Approval Form provided by ICM with the logo for approval will provide this number.

### 3. If choosing a font from the Sample Fonts, make sure the correct font number appears in the appropriate space on the form (under Logo Art Origin).

### 4. If choosing to provide a formatted logo.

- It is important to provide the Graphics Specifications on the Simple Comfort® & i3 Series Custom Logo Request Form to the Company or Person providing the art for the Logo.
- We suggest getting a commitment from the graphics provider as to when the logo will be submitted to ICM and following up with them and ICM to be sure the logo has been received.
- If the logo is not submitted and/or received there will be no logo for the thermostats.
- Be sure to submit the Custom Logo Request Form completely filled out with a clean/enlarged hard copy of the graphics to be provided for the logo attached. Review this copy with the contractor before submitting to ICM, so that anything on the Logo that should not appear on the thermostat is noted.

### 5. A Custom Logo Approval Form will be sent for approval with an L#### provided.

- This form must be returned to ICM with the Approval signatures.
- The L#### must be used on the PO when ordering with the thermostat part #. This ensures the specific Logo, identified with the L#### is printed on the selected thermostat. Replacement covers for **Simple Comfort® Thermostat logos that are incorrectly ordered are \$3.75 each.** Incorrectly ordered **i3 Series Custom Tab Logos are \$1.00 each.** Refer to the Custom Logo Approval Form for more information.
- Custom Logo Approval Forms are expected to be returned to ICM with approvals within 10 days with a Purchase Order using the L#### and Thermostat part # as shown on the Approval Forms.
- Failure to return the approved Custom Logo Approval Form or a PO will cause delays.

### 6. If you need further assistance, or have questions please contact: Jim Kocik @ 800.365.5525 x321.

Copyright© 2021 ICM Controls. All rights reserved. No part of this catalog may be reproduced, stored in a retrieval system or transmitted in any form, by any means, electronic, mechanical, photocopying or otherwise, without the express written consent of the publisher. **SIMPLECOMFORT®** is a registered trademark of ICM Controls.



## Simple Comfort® Thermostat

## Custom Logo Request Form

This form is available on the home page of our web site at [www.icmcontrols.com](http://www.icmcontrols.com) and in the back of our catalog.

Wholesale Information	Wholesaler Name		Wholesaler Contact Person
	Wholesaler Phone Number	Wholesaler Fax Number	Wholesaler Email Address
	Contractor Name		
Contractor Information	Contractor Contact Person		
	Contractor Address (City, State and Zip Code)		
	Contractor Phone Number	Contractor Fax Number	Contractor Email Address

### Simple Comfort® Logo specifications (3 lines maximum)

**Approximate logo dimensions:** 1.5”w x 0.7”h. **Final Logo size:** Will be determined by ICM. If you can not read your logo when scaled to fit the box, it **WILL NOT** mark properly on a thermostat. Your logo should be modified accordingly to be legible. Logo is laser engraved into the thermostat.

**Note:** Blue box shows exterior boundaries of logo area. It will not be printed.

### LOGO ART ORIGIN (check one)

- A. Please create a basic imprint from the fonts on the right.
- Use font # \_\_\_\_ for this logo. (Choose from 1 to 22 from list on right)
- LINE 1: \_\_\_\_\_
- LINE 2: \_\_\_\_\_
- LINE 3: \_\_\_\_\_
- B. Accommodations made to have the graphics for a properly formatted logo emailed to [jkocik@icmcontrols.com](mailto:jkocik@icmcontrols.com).  
**Note:** See Graphics Specifications below.
- C. Submitting changes to existing logo. Please provide existing L#### that requires changes:  
**Note:** New logo will receive a new L####, and must be used instead of the previous L####. Using the previous L#### on a PO will result in the Old L#### being printed on the thermostats.

Logo Change Notes

FONT #	SAMPLE FONT	FONT #	SAMPLE FONT
1	ALMONTE SNOW Made in the USA 800-365-5525	12	Block T Regular Made in the USA 800-365-5525
2	Avante Garde Made in the USA 800-365-5525	13	CG Omega Made in the USA 800-365-5525
3	Myriad Pro Made in the USA 800-365-5525	14	Charcol Made in the USA 800-365-5525
4	Antique O Bold Made in the USA 800-365-5525	15	Clearface Gothic Bold Made in the USA 800-365-5525
5	Barbedor T Bold Made in the USA 800-365-5525	16	Cooper Black Made in the USA 800-365-5525
6	Albertus Medium Made in the USA 800-365-5525	17	Micro FLF Made in the USA 800-365-5525
7	Bell MT Made in the USA 800-365-5525	18	Futura Made in the USA 800-365-5525
8	Blippo Bld Made in the USA 800-365-5525	19	Hobo D Made in the USA 800-365-5525
9	Tubular Regular Made in the USA 800-365-5525	20	LIBERTY D MADE IN THE USA 800-365-5525
10	Bodoni Ant T Bold Made in the USA 800-365-5525	21	Rockwell Made in the USA 800-365-5525
11	Broadway D Made in the USA 800-365-5525	22	Trebuchet MS Made in the USA 800-365-5525

### GRAPHICS SPECIFICATIONS:

(Please forward this information to your graphics company or graphics provider.)

- Required Formats:** Illustrator or any vector file with text converted to outline/paths/curves.
- Acceptable logo formats to submit:** (a) **100% black logo only** (no color or grey scale), 300 dpi JPEG, EPS, or TIFF files. (b) Adobe Illustrator vector file with fonts converted to outlines
- Unacceptable logo file formats:** BMPs, Corel Draw files, DAT files, DXF/CAD files, GIF files, PNG files, Low-res scans, MSWord files, Page Maker files, PowerPoint files, Quark Xpress files, Window metafiles, and web site images less than 300 dpi.
- Email logo to: [jkocik@icmcontrols.com](mailto:jkocik@icmcontrols.com)

# CUSTOM LOGO FORM – i3™ THERMOSTATS

## i3™ Series Custom Tabs

### Custom Logo Request Form

This form is available on the home page of our web site at [www.icmcontrols.com](http://www.icmcontrols.com) and in the back of our catalog.

Wholesale Information	Wholesaler Name		Wholesaler Contact Person
	Wholesaler Phone Number	Wholesaler Fax Number	Wholesaler Email Address
	Contractor Name		Contractor Contact Person
Contractor Information	Contractor Address (City, State and Zip Code)		
	Contractor Phone Number	Contractor Fax Number	Contractor Email Address



### i3™ Series Custom Tab Specifications (1 line maximum)

**Approximate logo dimensions:** 1.75" w x 3/8" h. If you can not read your logo when scaled to fit the box, it **WILL NOT** mark properly on a thermostat. Your logo should be modified accordingly to be legible. Logo is laser engraved into the tab.  
**Note:** Blue box shows exterior boundaries of logo area. It will not be printed.

### LOGO ART ORIGIN (check one)

- A. Please create a basic imprint from the fonts on the right.**  
 Use font # \_\_\_\_ for this logo. (Choose from 1 to 22 from list on right)  
 LINE 1: \_\_\_\_\_
- B. Accommodations made to have the graphics for a properly formatted logo emailed to [jkocik@icmcontrols.com](mailto:jkocik@icmcontrols.com).**  
**Note:** See Graphics Specifications below.
- C. Submitting changes to existing logo. Please provide existing L#### that requires changes:**  
**Note:** New logo will receive a new L####, and must be used instead of the previous L####. Using the previous L#### on a PO will result in the Old L#### being printed on the thermostats.

Logo Change Notes

FONT #	SAMPLE FONT	FONT #	SAMPLE FONT
1	<i>Made in the USA</i>	12	<b>Made in the USA</b>
2	<b>Made in the USA</b>	13	Made in the USA
3	Made in the USA	14	<b>Made in the USA</b>
4	<b>Made in the USA</b>	15	Made in the USA
5	Made in the USA	16	<b>Made in the USA</b>
6	Made in the USA	17	<b>Made in the USA</b>
7	Made in the USA	18	<b>Made in the USA</b>
8	<b>Made in the USA</b>	19	<b>Made in the USA</b>
9	<i>Made in the USA</i>	20	MADE IN THE USA
10	<b>Made in the USA</b>	21	Made in the USA
11	<b>Made in the USA</b>	22	Made in the USA

### GRAPHICS SPECIFICATIONS:

(Please forward this information to your graphics company or graphics provider.)

- Required Formats:** Illustrator or any vector file with text converted to outline/paths/curves.
- Acceptable logo formats to submit:** (a) **100% black logo only** (no color or grey scale), 300 dpi JPEG, EPS, or TIFF files. (b) Adobe Illustrator vector file with fonts converted to outlines
- Unacceptable logo file formats:** BMPs, Corel Draw files, DAT files, DXF/CAD files, GIF files, PNG files, Low-res scans, MSWord files, Page Maker files, PowerPoint files, Quark Xpress files, Window metafiles, and web site images less than 300 dpi.
- Email logo to: [jkocik@icmcontrols.com](mailto:jkocik@icmcontrols.com)



ICM Controls Corp. 7313 William Barry Blvd. North Syracuse, NY 13212



[WWW.ICMCONTROLS.COM](http://WWW.ICMCONTROLS.COM)

Copyright © 2021 ICM Controls

All features and specifications are subject to change without notice. All rights reserved. No part of this catalog may be reproduced, stored in a retrieval system or transmitted in any form, by any means, electronic, mechanical, photocopying or otherwise, without the express written consent of the publisher.



PHONE: 1-800-365-5525 FAX: 315-233-5276 WEB: [WWW.ICMCONTROLS.COM](http://WWW.ICMCONTROLS.COM)

All features and specifications are subject to change without notice.





---

ICM CONTROLS CORP. 7313 WILLIAM BARRY BLVD. NORTH SYRACUSE, NY 13212  
phone: 1-800-365-5525 fax: 315-233-5276 web: [www.icmcontrols.com](http://www.icmcontrols.com)

LIC037-1