

MOEN®

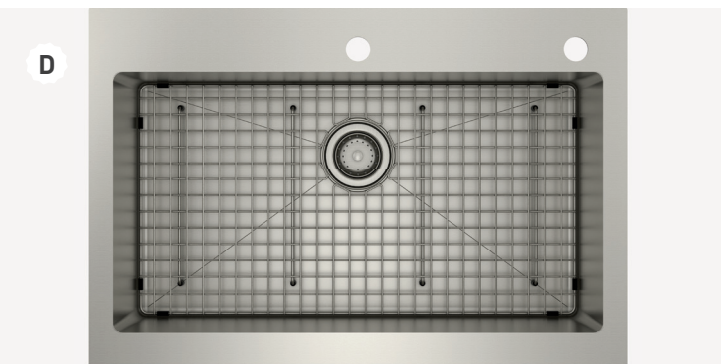

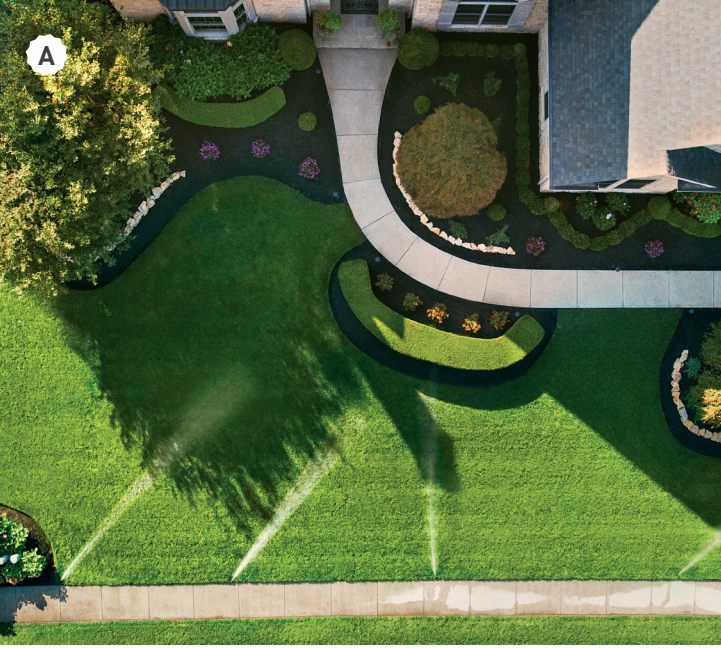

SMART WATER NETWORK

- 42 **Collection Feature:**
Smart Water Network
- 44 Smart Customizable Water
- 50 Smart Water Security
- 52 Smart Irrigation

KITCHEN AND BAR

- 54 **Collection Feature:** Cia™
- 59 Touchless Kitchen Faucets
- 70 Nio™
- 71 STō™
- 72 Apphia™
- 72 Weymouth™
- 74 Sinema™
- 75 Paterson™
- 77 Cia™
- 78 Align™
- 81 KURV™
- 82 Brantford™
- 83 Arbor™
- 84 Belfield™
- 85 Genta™ LX
- 86 Sleek™
- 87 Camerist™
- 88 Integra™ and Method™
- 89 Chateau™
- 90 Banbury™
- 91 Pot Fillers
- 92 Bar/Prep Faucets
- 97 Laundry Faucets
- 99 Water Filtration
- 106 Soap Dispensers

KITCHEN SINKS

- 112 Fireclay Sinks
- 113 Granite Sinks
- 115 1800™ Series Workstation Sinks
- 116 1600™ Series
- 117 1800™ Series
- 119 Sink Accessories

DISPOSALS

- 125 EXL Series
- 126 GX Series
- 127 GT Series
- 128 GX Pro Series
- 129 Accessories

EBIDETS AND ETOILETS

- 133 Electronic Bidet Seats
- 134 Non-Electronic Bidet Seats
- 135 Electronic Cleansing Toilets

BATH AND SHOWER

- 136 **Collection Feature:**
Greenfield™
- 143 Touchless Bath Faucets
- 145 Weymouth™
- 159 Arris™
- 169 Flara™
- 182 Colinet™
- 193 90°™
- 205 Via™
- 207 Doux™
- 218 Greenfield™
- 229 Wynford™
- 240 Align™
- 252 Rizon™
- 261 Belfield™
- 274 Cia™
- 283 Voss™
- 297 Dartmoor™
- 304 Glyde™
- 310 Brantford™
- 319 Eva™
- 329 Vichy™
- 334 Gibson™
- 342 Genta™ LX
- 350 Chateau™

CUSTOM SHOWERING

- 360 **Collection Feature:**
Verso Rainshower Featuring
- 364 Smart Shower
- 367 ExactTemp™
¾" Thermostatic Showering
- 373 M-CORE™ Integrated
Transfer Valve Trim
- 380 M-CORE Transfer Valve Trim
- 409 Shower Rails
- 424 Posi-Temp™ Integrated
Transfer Valve Trim
- 429 Rainshowers
- 432 Showerheads
- 438 Handheld Showers
- 444 Magnetix Handheld Showers
- 447 Accessories and Body Sprays
- 453 Drains and Tub Spouts

VALVES

- 463 Bath and Showering Valves

COORDINATING ACCESSORIES

- 482 Mason™
- 483 Retreat™
- 484 Arlys™
- 485 Triva™
- 486 Sage™
- 487 Iso™
- 488 Kyvos™
- 489 Lounge™
- 490 Madison™
- 491 Preston™
- 492 Aspen™
- 493 Kingsley™
- 494 Gilcrest™ and Glenshire™
- 495 Donner™
- 495 Straight Shower Rods
- 496 Build-Your-Own
Straight Shower Rod
- 497 Contemporary
- 498 Stainless Steel
- 499 Economy Metal
- 500 Hotel/Motel
- 501 Recessed Fixtures
- 502 30" Towel Bars
- 503 Shower Rods and Rings
- 504 Curved Shower Rods
- 507 Tension Shower Rods
- 508 Shower Curtain Rings
- 509 Lighting
- 514 Knobs and Pulls
- 517 Bath Safety
- 520 Collection Concealed
Screw Grab Bars
- 526 Designer Grab Bars
- 530 Standard Grab Bars
- 531 Grab Bars with Accessories
- 531 SecureMount™ System
- 531 Hand Grips
- 532 Chairs, Seats and Benches
- 533 Tub, Shower and Toilet Safety
- 533 Handheld Shower

MOEN GENUINE REPLACEMENT PARTS

- 535 Moen Genuine Replacement Parts

BULK PACK PRODUCTS

- 589 Bulk Pack Products

COMMERCIAL FAUCETS, VALVES AND SHOWER

- 611 Commercial Faucets, Valves and
Shower

NEW IN 2023

A Smart Irrigation | **B** Pre-Rinse with *MotionSense Wave*™ | **C** 1800 Series Workstation Sinks | **D** 1800 Series Dual Mount Sinks | **E** Smart Handle-Free Faucet with Motion Control | **F** Arbor Laundry Faucet | **G** Greenfield Bath Collection | **H** Cia with Power Boost™ Pro | **I** 3-in-1 Water Filtration Pulldown Kitchen Faucets | **J** Verso Rainshower Featuring Infiniti Dial with Magnetix | **K** Matte Black Finish Extension for Select Bath Collections





Water. Our world's
most precious
resource. It runs
through our homes
and our lives,
creating moments
of relaxation,
restoration and joy.

At Moen®, we're committed to ensuring every experience you have with water in your home is an exceptional one, from leveraging technology to delivering water in an innovative, more customized way, to designing on-trend products that artfully combine form and function to reflect your personal style, to developing new ways to save water without sacrificing a spa-like sensation...simply put, it's your water, your way, every day.

In these pages, you'll find our latest fixtures and new innovations to enhance your daily interactions with water, all available in a wide range of finishes and styles to suit your personal preferences.



MISSION  MOEN.

We're innovating to save 1 trillion gallons of water and repurposing 2,000 tons of ocean plastic by 2030, all while helping you enjoy water even more.



Mission Moen is Moen's pledge to innovate, engineer and design for the water of tomorrow. Our goals are to work to save 1 trillion gallons of water and repurpose 2,000 tons of ocean-bound plastic by the year 2030, keeping our Earth's water beautiful for all. That's why Moen® is using recycled ocean plastic in the design of the Magnetix® docks for the Moen Quattro Handheld Shower and the Verso® Showerheads.

To learn more, visit [moen.com/mission-moen](https://www.moen.com/mission-moen)

Wholesale

Listed in numerical order

MODEL NUMBER	LIST PRICE	PAGE NO.	UNIVERSAL PRODUCT CODE	CASE QTY
2-100-5A	6.95	496	034584100108	50
2-100-6A	8.70	496	034584100115	50
2-10155SS	14.10	496	034584100092	25
2-102-5PS	27.80	507	034584003522	25
2-102-5BS	29.15	507	034584003539	25
2-100-5SS	37.65	496	034584100283	25
3W	0.30	497	034584100658	250
3C	1.80	497	034584100641	250
3CH	4.85	497	034584015945	200
52-F	4.85	496	034584100603	200
52-5	11.90	495	034584484741	50
52-6	13.45	495	034584484758	50
52-5-SS	18.85	495	034584484857	10
52-5-OWB	27.45	495	034584008244	10
52-5-BN	41.10	495	034584011909	10
54-F	1.45	496	034584100689	200
54-5	8.50	495	034584484765	50
54-6	10.10	495	034584484789	50
55-F	11.25	496	034584100429	50
55-5	48.80	495	034584484871	50
58-F	9.45	496	034584100443	50
58-5	47.10	495	034584484895	50
61-F	1.75	496	034584100610	200
61-5-SS	15.70	495	034584484918	50
63-F	4.70	496	034584100627	200
63-5	11.70	495	034584484802	50
63-5-SS	18.70	495	034584484949	50
63-5-HD	42.35	495	034584484932	50
65-F-PS	19.80	507	034584003546	25
65-F-BS	22.80	507	034584003553	25
117	7.10	542	026508001172	72
162	115.10	547	026508043349	6
208H2	173.95	443	026508324608	2
208H2SRN	191.35	443	026508325421	2
220C3	275.40	444	026508348123	2
220C3EP	275.40	444	026508348161	2
220R3	277.25	432	026508366271	2
220R3EP	277.25	432	026508366318	2
220C3BL	358.00	444	026508348147	2
220C3BN	358.00	444	026508348154	2
220C3EPBL	358.00	444	026508348185	2
220C3EPBN	358.00	444	026508348192	2
220R3BG	360.45	432	026508366288	2
220R3BN	360.45	432	026508366301	2
220R3EPBG	360.45	432	026508366325	2
220R3EPBN	360.45	432	026508366349	2
220C3BG	393.80	444	026508348130	2
220C3EPBG	393.80	444	026508348178	2
220R3BL	414.50	432	026508366295	2
220R3EPBL	414.50	432	026508366332	2
395	1,717.85	241	026508298367	1
395BG	2,319.15	241	026508298374	1
395BN	2,319.15	241	026508298398	1
395BL	2,550.95	241	026508298381	1
575	35.10	501	034584700230	20
588	4.15	501	034584701305	80
601	43.15	546	026508072158	12
615	1,717.85	275	026508335895	1
615BG	2,319.15	275	026508335901	1
615BN	2,319.15	275	026508335925	1
615BL	2,550.95	275	026508335918	1
620	1,717.85	218	026508364260	1
620BG	2,319.15	218	026508364277	1
620BN	2,319.15	218	026508364291	1
620BL	2,550.95	101	026508364284	1
655	1,874.95	230	026508298404	1
655BN	2,531.20	230	026508298411	1
655ORB	2,784.35	230	026508298435	1
695	1,874.95	284	026508280973	1
695BG	2,531.20	284	026508290415	1
695BN	2,531.20	284	026508280980	1
695NL	2,531.20	284	026508290422	1
695BL	2,624.95	284	026508371299	1
695ORB	2,784.35	284	026508280997	1
900-001	767.70	50	860000103503	2
900-006	846.10	50	860000103572	2
900-002	1,230.75	50	860000103534	2
902	1.90	499	034584711007	50
908	3.55	499	034584712004	100
910	3.30	499	034584719003	100
910A18	4.55	499	034584713001	24
910A24	5.10	499	034584714008	24
920-002	7.95	50	026508351246	20
920-003	18.75	50	860000103510	10
920-006	35.50	51	850015061011	36

MODEL NUMBER	LIST PRICE	PAGE NO.	UNIVERSAL PRODUCT CODE	CASE QTY
920-004	78.05	51	860000103596	8
920-005	203.00	51	850015061004	4
930-001	62.40	50	860000103541	24
930-002	62.40	50	860000103558	24
930-003	72.05	50	026508325438	24
930-004	72.05	50	026508325445	24
930-005	104.85	50	026508325452	24
930-006	104.85	50	026508325469	24
950	3.60	499	034584718006	200
1011	17.35	129	026508269176	24
1017	17.90	130	026508269190	50
1023	8.95	130	029122010230	24
1024	10.95	130	029122010247	24
1026	10.05	130	029122010261	6
1037	9.95	130	629122010850	10
1200	52.90	539	026508012000	36
1200B	52.90	541	026508005019	144
1212	85.00	539	026508342817	12
1213	110.00	539	026508328057	12
1214	389.00	539	026508360538	12
1215	110.00	541	026508356906	12
1222	88.30	539	026508014004	18
1222B	88.30	539	026508043868	72
1222HD	107.15	541	026508207604	18
1224	17.35	538	026508012246	36
1224B	17.35	541	026508004609	144
1225	33.35	538	026508012253	36
1225B	33.35	541	026508004616	144
1234	16.80	539	026508251669	18
1248	17.35	538	026508004623	18
1248B	17.35	541	026508043226	144
1255	34.15	539	026508199022	72
1258	17.40	539	026508251676	18
1576SS	12.40	501	034584704504	40
1824	21.30	130	026508269206	10
1920	73.15	552	026508019207	6
1920BN	106.20	552	026508199329	6
1920ORB	130.35	552	026508199336	6
2326PF	201.20	469	026508312339	6
2328PF	201.20	469	026508312346	6
2353	225.35	354	026508025697	12
2360PF	208.45	470	026508312353	3
2363	257.55	354	026508025703	12
2510	156.10	467	026508074541	6
2520	156.10	467	026508073001	6
2521	281.85	471	026508299999	6
2551	281.85	471	026508300008	6
2565CH	19.45	501	034584700131	36
2570	189.55	467	026508073018	6
2571	317.40	471	026508300015	6
2575	19.20	501	034584700162	36
2580	156.10	468	026508233566	6
2581	317.40	471	026508300022	6
2590	189.55	467	026508073025	6
2919EP	221.20	358	026508270783	6
2982EP	221.20	358	026508270790	6
2995EP	258.70	358	026508270806	6
3346	89.90	453	026508335819	6
3346BG	142.45	453	026508335826	6
3346BN	142.45	453	026508335840	6
3346BL	165.85	453	026508335833	6
3347	75.25	456	026508335857	6
3347BG	116.15	456	026508335864	6
3347BN	116.15	456	026508335888	6
3347BL	127.75	456	026508335871	6
3360	205.55	651	026508222768	6
3558EP	276.70	441	026508282274	6
3558EPBN	373.55	441	026508282281	6
3558EPBL	410.90	441	026508285442	6
3558EPORB	410.90	441	026508282298	6
3636EP	340.10	442	026508241677	6
3636EPBG	647.15	442	026508352267	6
3636EPBN	647.15	442	026508241684	6
3636EPBL	711.90	442	026508351017	6
3636EPORB	711.90	442	026508242773	6
3638	132.65	432	026508241691	12
3638EP	132.65	432	026508242131	12
3638EPBG	206.55	432	026508351383	12
3638EPBL	219.10	432	026508351390	12
3638BG	225.15	432	026508350959	12
3638BN	225.15	432	026508241707	12
3638EPBN	225.15	432	026508242148	12
3638BL	227.30	432	026508305980	12
3638ORB	247.75	432	026508242155	12
3662EP	228.85	444	026508279861	6

Wholesale

Listed in numerical order

SUGGESTED LIST PRICES

MODEL NUMBER	LIST PRICE	PAGE NO.	UNIVERSAL PRODUCT CODE	CASE QTY	MODEL NUMBER	LIST PRICE	PAGE NO.	UNIVERSAL PRODUCT CODE	CASE QTY
3662EPBG	310.25	444	026508351000	6	3960	72.95	455	026508004302	12
3662EPBN	310.25	444	026508279878	6	3988EP	326.50	441	026508282304	6
3662EPBL	378.35	444	026508324783	6	3988EPBN	648.75	441	026508282328	6
3662EPORB	390.35	444	026508279885	6	3988EPSRN	648.75	441	026508282359	6
3667EP	351.55	440	026508242162	6	4325	97.00	453	026508364796	6
3667EPBG	695.05	440	026508350973	6	4325BG	147.35	453	026508364802	6
3667EPBN	695.05	440	026508242179	6	4325BN	153.70	453	026508364826	6
3667EPNL	695.05	440	026508301197	6	4325BL	172.85	453	026508364833	6
3667EPBL	764.55	440	026508350997	6	4326	78.35	456	026508364840	6
3667EPORB	764.55	440	026508242186	6	4326BG	121.05	456	026508364819	6
3668EP	294.30	441	026508242193	6	4326BN	121.05	456	026508364857	6
3668EPBN	425.95	441	026508242209	6	4326BL	133.20	456	026508364789	6
3668EPORB	468.10	441	026508242216	6	4500	356.45	229	026508253649	3
3669EP	351.55	440	026508242223	6	4500BN	481.25	229	026508253656	3
3669EPBN	695.05	440	026508242230	6	4500ORB	516.90	229	026508255667	3
3669EPBL	764.55	440	026508290187	6	4505	354.30	229	026508255674	3
3669EPORB	764.55	440	026508242247	6	4505BN	478.35	184	026508255681	3
3670EP	393.80	439	026508300039	6	4505ORB	513.75	229	026508255704	3
3670EPBN	571.05	439	026508300053	6	4507	527.70	229	026508255711	3
3670EPBL	628.05	439	026508300046	6	4507BN	686.05	183	026508255728	3
3671EP	393.80	440	026508300060	6	4507ORB	738.80	229	026508255742	3
3671EPBN	571.05	440	026508300084	6	4736	323.00	97	026508357569	3
3671EPBL	628.05	440	026508300077	6	4792	188.55	464	026508229583	6
3737	102.30	454	026508265642	6	4793	213.55	464	026508229590	6
3737BN	148.50	454	026508265659	6	4794	203.60	464	026508244050	6
3737BL	163.35	454	026508337912	6	4796	177.65	464	026508229606	6
3737ORB	163.35	454	026508265666	6	4797	181.10	464	026508229613	6
3800	84.90	455	026508030639	12	4798	181.10	464	026508229620	6
3801	84.90	455	026508029473	12	4903	128.35	96	026508085325	12
3806	105.90	454	026508041680	12	4905	265.15	96	026508138748	3
3814	104.95	454	026508251041	6	4905SRS	331.40	96	026508242902	3
3814BN	152.30	454	026508251058	6	4925	195.80	350	026508002360	12
3814ORB	167.60	454	026508251065	6	4945	342.85	350	026508002537	6
3828	62.90	457	026508133736	12	4975	130.85	98	026508003206	12
3829	62.90	457	026508133743	12	5263EP15	56.35	662	026508237236	12
3829BN	144.25	457	026508133804	12	5263EP17	56.35	662	026508237250	12
3829BL	150.55	457	026508300091	12	5263EP15CBN	102.85	662	026508237243	12
3829ORB	158.70	457	026508134375	12	5263EP17CBN	102.85	662	026508237267	12
3839	73.15	455	026508239490	12	5520NC	14.40	500	034584741066	24
3839BN	106.15	455	026508260203	1	5571	28.10	500	034584115713	20
3839BL	116.65	455	026508294840	12	5577	50.25	500	034584700605	20
3853	74.80	455	026508070345	12	5622	530.55	94	026508352281	3
3853BRB	115.15	455	026508271858	12	5622SRS	663.20	94	026508352311	3
3853BN	155.20	455	026508164518	12	5622BL	689.75	94	026508352304	3
3853ORB	170.70	455	026508164525	12	5622BG	769.30	94	026508352298	3
3857	103.05	454	026508070406	6	5802CH	5.95	492	034584220011	24
3857BN	149.55	454	026508162453	6	5808CH	13.35	492	034584220028	3
3857ORB	164.50	454	026508162460	6	5818CH	15.65	492	034584220035	3
3858	92.45	456	026508162477	6	5824CH	17.95	492	034584220042	3
3858BN	134.25	456	026508162484	6	5882	373.85	96	026508351925	3
3858BL	147.70	456	026508357590	6	5882SRS	471.10	96	026508351949	3
3858ORB	147.70	456	026508162491	6	5882BL	486.05	96	026508351932	3
3863EP	320.60	441	026508219539	6	5886CH	10.50	492	034584220073	3
3863EPBN	669.60	441	026508219546	6	5923	635.75	66	026508267028	3
3865EP	244.65	442	026508221495	6	5923SRS	794.65	79	026508267035	3
3865EPBN	355.20	442	026508221501	6	5923EWC	794.75	66	026508279007	3
3865EPORB	390.95	442	026508227619	6	5923BL	826.45	79	026508282557	3
3868EP	294.30	441	026508221532	6	5923BG	921.80	79	026508329573	3
3868EPBG	425.95	441	026508285176	6	5923BLS	921.80	79	026508294505	3
3868EPBN	425.95	441	026508221549	6	5923EWSRS	993.40	66	026508279014	3
3868EPORB	468.10	441	026508227633	6	5923EWSBL	1,033.15	66	026508291054	3
3887EP	359.15	440	026508222157	6	5923EWSBG	1,152.35	66	026508329580	3
3887EPBG	713.70	440	026508285183	6	5923EWSBLS	1,152.35	66	026508294512	3
3887EPBN	713.70	440	026508223239	6	5925	503.45	68	026508315316	3
3887EPBL	756.25	440	026508283509	6	5925SRS	629.30	87	026508315347	3
3890	97.15	454	026508174746	12	5925EWC	653.50	68	026508373293	3
3890BN	141.05	454	026508174753	12	5925BL	654.45	87	026508315323	3
3890BL	148.40	454	026508294857	12	5925BLS	730.00	87	026508315330	3
3892	79.35	457	026508174760	12	5925EWSRS	816.80	68	026508373309	3
3892BG	122.50	457	026508285602	6	5925EWSBL	849.50	68	026508373279	3
3892BN	122.50	457	026508174777	12	5925EWSBLS	947.50	68	026508373286	3
3892BL	130.70	457	026508279427	6	5926	529.90	85	026508357606	3
3911	72.95	455	026508004258	12	5926SRS	662.40	85	026508358078	3
3919	16.60	540	026508039199	18	5926BL	688.90	85	026508358061	3
3924	16.60	540	026508039243	18	5927	531.70	84	026508358085	3
3926	70.95	455	026508004272	12	5927SRS	664.60	84	026508358115	3
3931	70.95	455	026508004289	12	5927BL	691.20	84	026508358092	3
3942	62.45	107	026508187586	6	5927ORB	744.35	84	026508358108	3
3942SRS	78.05	107	026508234341	6	5965	505.30	94	026508240007	3
3942BL	81.20	107	026508187890	6	5965SRS	631.65	94	026508240014	3
3944	61.25	107	026508187616	6	5965BL	656.90	94	026508282564	3
3944SRS	79.65	107	026508234358	6	5965BG	732.70	94	026508283851	3
3944BL	82.70	107	026508289907	6	5965BLS	732.70	94	026508289452	3
3944ORB	85.75	107	026508187937	6	5985ORB	622.40	95	026508211809	3
3959	71.05	457	026508004296	12	5995	415.30	95	026508207291	3

Wholesale

Listed in numerical order

MODEL NUMBER	LIST PRICE	PAGE NO.	UNIVERSAL PRODUCT CODE	CASE QTY
5995SRS	519.10	95	026508231968	3
5995BL	539.90	95	026508228395	3
5995ORB	581.40	95	026508209790	3
6126	494.00	95	026508335635	3
6126SRS	617.50	95	026508335659	3
6126BL	642.20	95	026508335642	3
6126NL	666.90	95	026508336700	3
6145	226.90	334	026508272060	3
6145BN	306.30	334	026508290064	3
6145BL	340.35	334	026508290170	3
6150	191.00	334	026508272077	3
6150BN	257.85	334	026508290088	3
6150BL	276.95	334	026508290071	3
6170	300.60	304	026508351147	3
6170BN	390.80	304	026508351178	3
6170BL	405.85	304	026508351161	3
6172	216.40	304	026508261163	3
6172BN	292.15	304	026508261170	3
6172BL	303.00	304	026508325506	1
6190	356.45	240	026508244913	3
6190BN	481.25	240	026508249567	3
6190BG	516.90	240	026508284674	3
6190BL	516.90	240	026508274989	3
6191	346.90	143	026508249598	3
6191BN	468.30	240	026508249604	3
6191BL	485.65	240	026508274996	3
6191BG	503.00	240	026508285930	3
6192	527.70	240	026508249611	3
6192BN	686.05	240	026508249628	3
6192BL	712.40	240	026508370872	3
6192BG	765.20	240	026508285947	3
6221	342.10	116	026508335932	3
6221BN	461.85	274	026508335963	3
6221BG	496.05	274	026508335949	3
6221BL	496.05	274	026508335956	3
6221EW	627.70	143	026508337790	3
6221EWBN	847.40	143	026508337820	3
6221EWBG	910.15	143	026508337806	3
6221EWBL	910.15	143	026508337813	3
6260	405.85	95	026508337530	3
6260SRS	507.30	95	026508337561	3
6260BL	527.60	95	026508337547	3
6260ORB	568.20	95	026508337554	3
6300	44.50	434	026508154724	12
6300EP	44.50	434	026508208557	12
6300EP15	44.50	434	026508241745	12
6300BN	67.90	434	026508207574	12
6300EPBN	67.90	434	026508208571	12
6302	114.75	433	026508142417	12
6302EP	114.75	433	026508208595	12
6302EP15	114.75	433	026508241752	12
6302BN	179.10	433	026508142431	12
6302EPBN	179.10	433	026508208625	12
6302EPORB	197.05	433	026508208632	12
6302ORB	197.05	433	026508142448	12
6302WR	197.05	433	026508142486	12
6303	63.45	434	026508153314	12
6303EP	63.45	434	026508208687	12
6303BN	97.20	434	026508153321	12
6303EPBN	97.20	434	026508208694	12
6303EPORB	106.90	434	026508208700	12
6303ORB	106.90	434	026508153338	12
6313	63.45	434	026508214862	12
6313BN	97.20	434	026508214879	12
6313ORB	106.90	434	026508214886	12
6322	113.35	433	026508239506	12
6322EP	113.35	433	026508239513	12
6322BN	186.95	433	026508260210	12
6322EPBN	186.95	433	026508260227	12
6322BL	187.20	433	026508290095	12
6322EPBL	187.20	433	026508290101	12
6325	113.35	433	026508230107	12
6325EP	113.35	433	026508230121	12
6325BG	177.00	433	026508285251	12
6325BN	177.00	433	026508230114	12
6325EPBG	177.00	433	026508285268	12
6325EPBN	177.00	433	026508230138	12
6325EPNL	177.00	433	026508301210	12
6325NL	177.00	433	026508301227	12
6325EPORB	194.85	433	026508230145	12
6325ORB	194.85	433	026508230152	12
6345	109.75	430	026508238554	3
6345EP	109.75	430	026508281857	3
6345BG	123.65	430	026508337837	3
6345BN	123.65	430	026508271469	3

MODEL NUMBER	LIST PRICE	PAGE NO.	UNIVERSAL PRODUCT CODE	CASE QTY
6345EPBG	123.65	430	026508337844	3
6345EPBN	123.65	430	026508281864	3
6345BL	137.50	430	026508306000	3
6345EPBL	137.50	430	026508306017	3
6345EPORB	137.50	432	026508281871	3
6345ORB	137.50	432	026508271476	3
6370EP	68.50	433	026508281840	12
6370	71.90	433	026508266632	12
6370EPBN	104.85	433	026508281796	3
6370BN	110.05	433	026508266687	12
6370EPBL	115.40	433	026508325520	12
6370BL	121.20	433	026508325513	12
6371EP	68.50	434	026508281802	12
6371	71.90	434	026508266625	12
6371EPBN	104.85	434	026508281819	12
6371BN	110.05	434	026508266649	12
6371EPBL	115.40	434	026508342305	12
6371EPORB	115.40	434	026508281826	12
6371BL	121.20	434	026508342299	12
6371ORB	121.20	434	026508266670	12
6399	122.35	433	026508174722	12
6399EP	122.35	433	026508208762	12
6399EP15	122.35	433	026508274682	12
6399BG	190.95	433	026508285954	12
6399BN	190.95	433	026508174739	12
6399EPBG	190.95	433	026508285961	12
6399EPBN	190.95	433	026508208779	12
6399BL	210.15	433	026508275009	12
6399EP15BL	210.15	433	026508275016	12
6399EPBL	210.15	433	026508275023	12
6400	300.60	319	026508195369	3
6400BN	390.80	319	026508195376	3
6400ORB	420.85	319	026508195383	3
6401	364.35	261	026508275337	3
6401BN	473.70	261	026508275344	3
6401BL	491.90	261	026508371350	3
6401NL	510.10	261	026508301234	3
6401ORB	510.10	261	026508275351	3
6402	351.25	261	026508275153	3
6402BN	456.65	261	026508275160	3
6402BL	474.20	261	026508371343	3
6402NL	491.75	261	026508301241	3
6402ORB	491.75	261	026508275177	3
6410	216.40	319	026508153109	6
6410BN	292.15	319	026508153116	6
6410ORB	313.80	319	026508153123	6
6504	356.45	218	026508364215	3
6504BN	445.60	218	026508364246	3
6504BL	481.25	218	026508364239	3
6504BG	516.90	218	026508364222	3
6512EP	134.65	432	026508290408	12
6512EPBN	216.35	432	026508290385	12
6512EPBL	238.10	432	026508290392	12
6600	300.60	310	026508195390	3
6600BN	390.80	310	026508195406	3
6600ORB	420.85	310	026508195413	3
6610	216.40	105	026508162057	6
6610BN	292.15	310	026508160992	6
6610ORB	313.80	310	026508161005	6
6702	217.40	342	026508271186	3
6702BN	282.65	342	026508290125	3
6702BL	304.40	342	026508290118	3
6710	274.50	193	026508273074	3
6802	216.40	297	026508264386	3
6802BN	292.15	297	026508264393	3
6802BL	303.00	297	026508336977	3
6802ORB	313.80	297	026508264409	3
6803	300.60	297	026508351185	3
6803BN	390.80	297	026508351208	3
6803BL	405.85	297	026508351192	3
6803ORB	420.85	297	026508351154	3
6900	356.45	252	026508235096	3
6900BL	516.90	252	026508301258	3
6901	340.00	283	026508230169	3
6901BN	459.05	283	026508230176	3
6901BL	476.05	283	026508372197	3
6901NL	476.05	283	026508301265	3
6901BG	493.05	283	026508284629	3
6901ORB	493.05	283	026508230183	3
6903	342.10	283	026508230190	3
6903BN	461.85	283	026508230206	3
6903BL	478.95	283	026508372180	3
6903NL	478.95	283	026508297582	3
6903BG	496.05	283	026508284636	3
6903ORB	496.05	283	026508230213	3

Wholesale

Listed in numerical order

SUGGESTED LIST PRICES

MODEL NUMBER	LIST PRICE	PAGE NO.	UNIVERSAL PRODUCT CODE	CASE QTY	MODEL NUMBER	LIST PRICE	PAGE NO.	UNIVERSAL PRODUCT CODE	CASE QTY
7050	130.45	90	026508274750	3	7622EWC	752.40	65	026508352410	3
7051	142.80	90	026508274774	3	7622BL	768.50	78	026508352342	3
7051SRS	178.50	90	026508274781	3	7622BG	857.15	78	026508352335	3
7165	522.25	80	026508240021	3	7622EVC	913.65	63	026508352373	3
7165SRS	652.80	80	026508240038	3	7622EWSRS	940.50	65	026508352427	3
7165BL	678.90	80	026508317785	3	7622EWBL	978.10	65	026508352403	3
7185C	484.75	82	026508211786	3	7622EVSRS	1,005.00	63	026508352380	3
7185SRS	605.90	82	026508242940	3	7622EVBL	1,050.70	63	026508352366	3
7185EWC	641.05	67	026508292686	3	7622EWBG	1,090.95	65	026508352397	3
7185ORB	678.65	82	026508211816	3	7622EVBG	1,096.35	63	026508352359	3
7185EWSRS	801.30	67	026508292709	3	7664	370.10	96	026508316450	3
7185EVC	811.10	64	026508303603	3	7664SRS	462.65	96	026508316498	3
7185EVSRS	892.20	64	026508303627	3	7664BL	481.15	96	026508316467	3
7185EWORB	897.45	67	026508292693	3	7664ORB	518.15	96	026508316481	3
7185EVORB	973.35	64	026508303610	3	7664BG	536.65	96	026508349922	3
7245C	391.60	85	026508259900	3	7664BLS	536.65	96	026508316474	3
7245SRS	489.50	85	026508259924	3	7822	850.00	78	026508357781	3
7245BL	509.05	85	026508337585	3	7822SRS	1,062.50	78	026508357811	3
7245ORB	548.20	85	026508259917	3	7822BL	1,105.00	78	026508357804	3
7250C	318.40	85	026508259931	3	7822BG	1,232.50	78	026508357798	3
7250SRS	398.00	85	026508259955	3	7825	226.20	88	026508138786	3
7250BL	413.90	85	026508337592	3	7825SRS	282.75	88	026508242988	3
7250ORB	445.75	85	026508259948	3	7840	269.70	88	026508138847	3
7255C	370.10	85	026508259962	3	7840SRS	337.15	88	026508243008	3
7255SRS	462.65	85	026508259986	3	7864	411.25	64	026508278444	3
7255BL	481.15	85	026508337608	3	7864SRS	514.05	87	026508278468	3
7255ORB	518.15	85	026508259979	3	7864BL	534.60	87	026508278451	3
7260	451.00	64	026508337615	3	7864EWC	567.55	68	026508279052	3
7260SRS	563.70	84	026508337721	3	7864ORB	575.70	87	026508316504	3
7260BL	586.25	84	026508337622	3	7864BG	596.30	87	026508349939	3
7260EWC	607.30	67	026508337684	3	7864BLS	596.30	87	026508294543	3
7260ORB	631.35	84	026508337714	3	7864EWSRS	709.40	68	026508279069	3
7260EWSRS	759.10	67	026508337707	3	7864EVC	736.35	64	026508303771	3
7260EVC	776.75	64	026508337646	3	7864EWBL	737.80	68	026508289921	3
7260EWBL	789.45	67	026508337677	3	7864EVSRS	809.95	64	026508303788	3
7260EWORB	850.20	67	026508337691	3	7864EWBG	822.90	68	026508351093	3
7260EVSRS	854.45	64	026508337660	3	7864EWBLS	822.90	68	026508294550	3
7260EVBL	893.25	64	026508337639	3	7864EVBL	846.80	64	026508303757	3
7260EVORB	932.10	64	026508337653	3	7864EVBG	883.60	64	026508350515	3
7295SRS	549.85	83	026508267165	3	7864EVBLS	883.60	64	026508303764	3
7365	459.50	80	026508251171	3	7871	452.40	87	026508316566	3
7365SRS	574.40	80	026508251188	3	7871SRS	565.50	87	026508316603	3
7365BL	597.35	80	026508317778	3	7871BL	588.10	87	026508316573	3
7412	24.20	530	034584175373	6	7882	449.45	67	026508279311	3
7423	176.95	89	026508053157	6	7882SRS	561.85	86	026508279328	3
7425	173.65	89	026508052938	6	7882BL	584.30	86	026508289938	3
7425SRS	217.05	89	026508274873	6	7882EWC	605.75	67	026508350539	3
7430	218.50	89	026508052853	6	7882EWSRS	757.20	67	026508350546	3
7430SRS	273.10	89	026508274880	6	7882EWBL	787.50	67	026508350522	3
7434	218.50	89	026508053034	6	7906	164.85	89	026508003398	6
7437	223.20	89	026508053126	6	7907	207.40	89	026508030318	6
7545C	439.90	87	026508138816	3	8103	182.95	623	026508162309	6
7545SRS	549.85	87	026508242964	3	8113	271.05	623	026508162279	6
7545ORB	615.85	87	026508164907	3	8116	335.10	623	026508162316	6
7565	563.00	80	026508240045	3	8119	317.75	622	026508162330	6
7565SRS	703.70	80	026508240052	3	8124	269.30	623	026508026168	6
7565EWC	727.60	66	026508342794	3	8126	318.60	622	026508162347	6
7565BL	731.85	80	026508274736	3	8137	256.55	622	026508185476	6
7565BG	816.30	80	026508283868	3	8138	305.40	622	026508199046	6
7565BLS	816.30	80	026508294536	3	8210F05	209.90	617	026508235430	6
7565EVC	889.60	63	026508303665	3	8210F12	209.90	617	026508266847	6
7565EWSRS	909.50	66	026508342800	3	8210SMF05	209.90	617	026508258866	6
7565EWBL	945.85	66	026508303696	3	8210SMF12	209.90	617	026508266854	6
7565EVSRS	978.55	63	026508303672	3	8215F03	232.75	617	026508235447	6
7565EVBL	1,023.05	63	026508303641	3	8215F05	232.75	617	026508235454	6
7565EWBG	1,055.00	66	026508303689	3	8215F12	232.75	617	026508266946	6
7565EWBLS	1,055.00	66	026508303702	3	8215SMF12	232.75	617	026508266830	6
7565EVBG	1,067.50	63	026508303634	3	8220F05	328.75	616	026508235508	3
7565EVBLS	1,067.50	63	026508303658	3	8225	341.35	619	026508162439	3
7585C	257.65	88	026508270318	3	8225SMF15	341.35	619	026508238684	3
7585SRS	322.10	88	026508270325	3	8226	263.75	619	026508155431	6
7594C	462.60	83	026508205037	3	8227	320.60	619	026508162255	3
7594SRS	578.25	83	026508231982	3	8228F05	349.50	616	026508235522	3
7594BL	601.35	83	026508228388	3	8228F12	349.50	616	026508266823	3
7594EWC	618.90	67	026508279021	3	8229	284.60	619	026508162262	6
7594ORB	647.65	83	026508209806	3	8230	218.45	623	026508172179	3
7594EWSRS	773.60	67	026508279045	3	8242	367.70	617	026508185483	3
7594EVC	788.60	64	026508303726	3	8244	388.40	617	026508185490	3
7594EWBL	804.55	67	026508289914	3	8248	334.30	619	026508181089	3
7594EWORB	866.45	67	026508279038	3	8248SMF12	334.30	619	026508267073	3
7594EVSRS	867.45	64	026508303740	3	8270	249.65	618	026508154618	6
7594EVBL	906.90	64	026508303719	3	8276	224.10	618	026508167717	6
7594EVORB	946.30	64	026508303733	3	8277	227.10	622	026508199060	6
7622	591.15	63	026508352328	3	8278	263.05	618	026508167809	6
7622SRS	738.95	78	026508352434	3	8278SM	263.05	618	026508238714	6

Wholesale

Listed in numerical order

MODEL NUMBER	LIST PRICE	PAGE NO.	UNIVERSAL PRODUCT CODE	CASE QTY	MODEL NUMBER	LIST PRICE	PAGE NO.	UNIVERSAL PRODUCT CODE	CASE QTY
8278SMF12	263.05	618	026508267080	6	8439F05	156.65	631	026508232675	12
8279SM	279.90	618	026508238738	6	8551	644.95	639	026508249901	6
8279SMF12	279.90	618	026508267097	6	8551AC	663.95	642	026508249918	6
8279	284.65	618	026508167816	6	8552	719.95	639	026508249925	6
8280	252.80	620	026508154632	6	8552AC	719.95	642	026508249932	6
8285	273.55	620	026508161203	6	8553	644.95	639	026508249949	6
8287	315.10	117	026508162231	6	8553AC	663.95	642	026508249956	6
8289	335.75	620	026508162248	6	8553BN	806.20	639	026508343722	6
8290EP15	121.45	662	026508213360	12	8553ACBN	829.95	640	026508344606	6
8290	126.35	662	026508154069	12	8553BL	870.70	639	026508343715	6
8292	131.90	662	026508172186	12	8553ACBL	896.35	640	026508344590	6
8310MR128	159.55	648	026508236550	6	8554	719.95	640	026508249963	6
8310M128	198.30	648	026508236529	3	8554AC	719.95	642	026508249970	6
8310M16	198.30	648	026508236536	3	8554ACBN	899.95	642	026508344620	6
8310M35	198.30	648	026508236543	3	8554BN	899.95	640	026508343746	6
8310R16	532.60	645	026508160329	3	8554ACBL	971.95	642	026508344613	6
8310SR128	532.60	645	026508265178	3	8554BL	971.95	640	026508343739	6
8310SR35	532.60	645	026508265192	3	8558	523.45	636	026508271995	3
8310RDF16	559.15	645	026508205983	3	8558BN	654.30	636	026508343760	3
8310	636.50	644	026508006412	3	8558BL	706.65	636	026508343753	3
8310AC16	636.50	644	026508167649	4	8559	615.25	636	026508271483	6
8310S35	636.50	644	026508265123	3	8559BN	769.05	636	026508343777	6
8310ACDF16	668.20	644	026508205969	4	8559BL	830.60	636	026508341599	6
8310DF16	668.20	644	026508205976	3	8560	523.45	636	026508272008	3
8311	636.50	644	026508199077	3	8560BN	654.30	636	026508343791	3
8311AC12	636.50	644	026508199091	3	8560BL	706.65	636	026508343784	1
8312M0125	198.30	648	026508236574	3	8562	1,117.10	637	026508271490	3
8312M05	198.30	648	026508236581	3	8565	639.80	637	026508271506	3
8312M10	198.30	648	026508236598	3	8701	155.20	621	026508129739	12
8312R10	532.60	645	026508160305	3	8707	184.90	621	026508206515	6
8312SR05	532.60	645	026508265260	3	8713	465.70	621	026508020951	6
8312SR125	532.60	645	026508265284	3	8716	33.00	526	034584017871	6
8312	636.50	644	026508152225	4	8717	274.05	621	026508237649	6
8312AC10	636.50	645	026508167656	4	8718	34.20	527	034584178251	6
8315	636.50	644	026508199084	3	8724	35.35	526	034584175465	6
8315AC05	636.50	645	026508199107	3	8730	39.90	528	034584175472	6
8316	636.50	644	026508205990	3	8732	41.95	528	034584175489	6
8316AC	636.50	645	026508213223	3	8736	46.70	527	034584175496	6
8342	694.15	653	026508078266	1	8742	50.55	527	034584175502	6
8342EP15	694.15	653	026508213377	0	8748	55.55	527	034584175519	6
8343	712.90	651	026508083130	1	8780	125.75	633	026508021859	6
8346	492.80	654	026508063347	4	8792	287.00	633	026508125717	6
8346EP15	492.80	654	026508213384	4	8798	201.55	633	026508003930	6
8349	79.90	662	026508015094	6	8799	262.70	633	026508013779	6
8349EP15	79.90	662	026508213391	6	8800	174.65	632	026508007778	6
8349EP17	79.90	662	026508228647	6	8800F05	174.65	632	026508235317	6
8349EP15CBN	116.35	662	026508237045	6	8810	200.25	632	026508007785	6
8349EP17CBN	116.35	662	026508237052	6	8820	206.30	632	026508007792	6
8360	243.70	660	026508086810	6	8884	189.05	627	026508093238	6
8370HD	139.65	651	026508228470	6	8886	348.45	203	026508093245	6
8370	198.10	651	026508013960	12	8889	446.00	627	026508093252	6
8371HD	168.05	651	026508228487	6	8894	214.65	627	026508220672	6
8372HD	168.05	651	026508228494	6	8912	31.60	529	034584175533	6
8373HD	168.05	651	026508228500	6	8915	128.40	632	026508094143	12
8374HD	181.15	651	026508228517	6	8917	151.35	632	026508030325	12
8375HD	168.05	651	026508239803	6	8922	270.65	485	026508039175	6
8375	223.20	651	026508040423	12	8924	289.60	529	026508039205	6
8375EP15	223.20	657	026508213407	12	8938	174.15	634	026508003954	6
8389EP15	254.90	656	026508213414	6	8942	56.95	529	034584175595	6
8400	188.20	630	026508015063	6	8948	171.80	529	026508061695	6
8413F03	179.75	616	026508234440	3	8957	134.15	445	026508030264	12
8413F05	179.75	616	026508234457	3	8992	110.40	529	034584015037	3
8413F12	179.75	616	026508266564	3	8994	111.25	529	034584015044	3
8414	214.50	616	026508137123	6	8996	118.65	529	034584015051	3
8414F12	214.50	616	026508269954	3	9000	162.15	463	026508081112	6
8414F12BN	268.15	616	026508271773	3	9001	110.80	546	026508094709	6
8416	193.05	616	026508017272	6	9025	1,874.95	261	026508298442	1
8416F05	193.05	616	026508234471	3	9025BN	2,531.20	261	026508298459	1
8417F05	248.30	615	026508234495	6	9025NL	2,531.20	261	026508298466	1
8417F12	248.30	615	026508266571	6	9025BL	2,624.95	261	026508372135	1
8419F05	282.05	615	026508227848	6	9025ORB	2,784.35	261	026508298473	1
8419F12	282.05	615	026508266588	6	9126	548.90	63	026508335666	3
8420	218.40	630	026508015070	12	9126SRS	686.10	81	026508335741	3
8422	197.45	491	026508232125	12	9126EWC	710.15	66	026508335727	3
8422F05	197.45	630	026508232149	12	9126BL	713.55	81	026508335673	3
8425	212.65	630	026508015087	12	9126NL	741.00	82	026508336748	3
8430	147.15	630	026508066454	12	9126EVC	871.40	63	026508335697	3
8430F05	147.15	630	026508232156	12	9126EWSRS	887.70	66	026508335734	3
8430CBN	183.95	630	026508235348	12	9126EWSRS	923.20	66	026508335710	3
8432	181.10	630	026508066461	12	9126EWSRS	958.55	63	026508335703	3
8432F05	181.10	630	026508264706	12	9126EWNL	958.70	66	026508336731	3
8434	174.60	631	026508066478	12	9126EVL	1,002.10	63	026508335680	3
8437	190.55	631	026508232163	12	9126EVNL	1,045.65	63	026508336724	3
8437CBN	238.20	631	026508235355	12	9263EP15	77.05	662	026508255438	12
8439	156.65	631	026508232170	12	9265	321.95	471	026508255155	6

Wholesale

Listed in numerical order

SUGGESTED LIST PRICES

MODEL NUMBER	LIST PRICE	PAGE NO.	UNIVERSAL PRODUCT CODE	CASE QTY	MODEL NUMBER	LIST PRICE	PAGE NO.	UNIVERSAL PRODUCT CODE	CASE QTY
9417F05	274.75	615	026508257296	3	52714	52.90	663	026508249871	12
9417F12	274.75	615	026508266977	3	52716EP15	74.20	662	026508213353	20
9419F05	305.30	615	026508255483	3	52740EP17	291.30	661	026508228524	6
9419F12	305.30	615	026508266984	3	52748EP15	212.95	661	026508234754	6
9480	170.05	629	026508255490	3	62300	145.15	467	026508025857	12
9482	188.95	629	026508255506	3	62320	145.15	467	026508009208	12
9501	67.05	105	026508153963	6	62330	192.40	469	026508102312	12
9601	67.05	105	026508153918	18	62340	161.05	468	026508102305	12
9700	229.35	463	026508230008	3	62345	145.15	469	026508252512	12
9792	424.85	464	026508229637	6	62360	176.45	468	026508102275	12
9793	434.80	464	026508229644	6	62360PF	196.55	470	026508337349	12
10066	29.10	549	026508037836	125	62365	145.15	468	026508227251	12
10066BN	41.10	549	026508117088	20	62365PF	165.35	470	026508337356	12
10066NL	41.75	549	026508146309	20	62370	176.45	467	026508009215	12
10066WR	45.50	549	026508117095	20	62380	145.15	468	026508102268	12
10154	26.45	435	026508050903	50	62380PF	165.35	470	026508337370	12
10154BRB	37.50	435	026508210628	20	62385	176.45	468	026508227268	12
10154BL	44.85	435	026508317440	30	62385PF	196.55	470	026508337387	12
10154BG	47.50	435	026508285213	30	62390	176.45	468	026508067055	12
10154BN	47.50	435	026508105344	50	62700	132.20	471	026508009277	12
10154NL	47.50	435	026508104248	1	62720	132.20	471	026508009284	12
10154ORB	52.25	435	026508100325	50	64601	151.80	594	026508040751	12
10399	42.45	548	026508033197	36	64621	186.55	594	026508002896	12
10510	29.10	549	026508037829	30	64900	118.65	597	026508040775	12
10709	14.85	546	026508027226	84	64919	164.55	597	026508017265	12
10709BC	20.75	546	026508172247	20	64920	164.55	597	026508002889	12
10709BG	46.35	546	026508291832	20	64922	118.65	597	026508147955	12
10709BN	46.35	546	026508172254	20	64925	164.55	597	026508134542	12
10709NL	50.95	546	026508204900	20	66172	195.10	596	026508261194	6
10709BL	51.05	546	026508326732	20	66410	195.10	596	026508152485	6
10709ORB	51.05	546	026508172261	20	66610	195.10	596	026508162064	6
10709WR	51.05	546	026508172308	50	66802	195.10	596	026508264379	6
10790	134.10	546	026508004166	12	67315C	313.00	88	026508069257	6
13382	12.70	543	026508028834	300	67315SRS	391.30	88	026508242933	6
14272	7.55	542	026508031087	150	67425	170.20	593	026508052983	6
14292	251.00	552	026508004180	0	67430	213.95	593	026508052884	12
14526	14.95	553	026508028308	0	67434	213.95	593	026508053041	6
14891	21.15	541	026508148914	60	67545C	410.25	592	026508209165	3
15856	63.60	663	026508015186	12	67840	258.00	592	026508138861	6
15856CBN	92.60	663	026508239858	12	69000	143.90	547	026508045114	6
20001	38.55	434	026508279663	3	74998	98.30	98	026508028070	12
20200	57.15	540	026508202005	18	90530	67.10	460	026508905302	10
22036	21.65	121	026508017593	24	91751	13.00	543	026508023655	1000
22037	18.95	121	026508008652	40	94514	13.50	543	026508021316	150
22174	9.80	121	026508038314	30	96107	19.55	553	026508961070	18
22175	4.95	122	026508036006	1000	96365	10.10	539	026508963654	36
22194	6.80	121	026508038321	100	96497	25.75	553	026508004708	12
22650	14.25	122	026508104385	1	96778	10.65	539	026508967782	36
22681	5.40	122	026508032336	1	96782	33.05	540	026508967829	18
22682	6.40	122	026508032374	1	96790	34.25	543	026508009048	150
22684	4.45	122	026508032299	1	96791	33.05	543	026508009055	150
22897	1.15	122	026508038307	1	96797	34.25	543	026508009062	150
23026	44.10	434	026508224281	4	96858	61.35	548	026508014486	25
23418A	1.80	497	034584100122	50	96868	75.30	548	026508014509	1
23418SS	3.35	498	034584100016	50	96914	6.90	542	026508030998	500
23424A	2.25	497	034584100146	50	96945	42.95	548	026508017609	100
23424SS	4.45	498	034584100023	50	96945BG	61.45	548	026508293164	9
23430A	2.90	497	034584100160	50	96945BN	61.45	548	026508120361	9
23430SS	5.80	498	034584100030	50	96945WR	67.55	548	026508118337	9
25818A	1.75	499	034584100184	50	96955	52.20	548	026508017616	100
25824A	2.30	499	034584100191	50	96987	11.30	549	026508028001	250
26100EP	69.80	444	026508266540	2	96987BG	15.95	549	026508293171	12
26100EPSRN	85.35	444	026508266557	2	96987BN	15.95	549	026508118344	20
26100EPBL	91.95	444	026508329276	2	96987NL	16.05	549	026508147139	20
52016F05	20.75	642	026508236284	100	96987WR	17.05	549	026508118351	20
52016F10	20.75	642	026508228708	24	96988	20.80	541	026508017586	100
52016	22.45	544	026508165065	24	97557	67.50	540	026508975572	36
52100	94.60	627	026508207635	24	98026	38.35	540	026508042472	12
52120	175.60	617	026508207048	12	98032	13.00	540	026508042533	18
52124GBM25	251.45	660	026508234112	3	98039	33.05	540	026508042601	18
52224GBP25	223.00	661	026508227008	3	98040	17.90	539	026508043400	18
52224GBM15	257.20	661	026508226964	3	98085	7.10	553	026508041901	225
52224GBM17	257.20	661	026508226971	3	99550	33.95	627	026508207659	12
52224GBM25	257.20	661	026508226995	3	99551	33.95	627	026508220689	12
52224GBM15CBN	527.15	661	026508236970	3	99556	37.15	639	026508252130	20
52236GBM15	280.05	661	026508227015	3	99557	37.15	639	026508252147	20
52236GBM17	280.05	661	026508227022	3	99557BN	46.45	639	026508343975	20
52236GBM25	280.05	661	026508227046	3	99557BL	51.05	639	026508343968	20
52236GBM15CBN	572.90	661	026508237007	3	99558	47.70	636	026508252154	20
52703	70.55	663	026508026083	12	99558BN	59.65	636	026508343869	20
52710	291.90	661	026508063361	6	99558BL	65.60	636	026508343708	20
52710EP15	291.90	661	026508213346	6	99559	37.15	615	026508258859	20
52710CBN	580.95	661	026508237106	6	99596	43.35	546	026508020920	0
52710EP15CBN	580.95	661	026508237144	6	99915	0.25	542	026508045541	2500
52711	52.90	663	026508228630	12	100224	23.25	552	026508092262	45

Wholesale

Listed in numerical order

MODEL NUMBER	LIST PRICE	PAGE NO.	UNIVERSAL PRODUCT CODE	CASE QTY
100679	68.70	552	026508057704	12
100686	53.05	663	026508057711	60
100686CBN	76.25	663	026508246436	60
100710	24.45	540	026508059524	18
100817	37.25	547	026508124185	100
100818	39.90	547	026508124192	20
101100	36.35	549	026508096550	100
101205	12.70	540	026508060575	18
101663BG	40.45	460	026508285411	12
101663BN	40.45	460	026508120897	12
101663WR	44.55	460	026508120927	12
101663ORB	46.05	460	026508100349	12
101664BG	50.25	460	026508285428	12
101664BN	50.25	460	026508120903	12
101664WR	55.40	460	026508120934	12
101664ORB	57.10	460	026508100363	12
102763BG	50.25	460	026508285435	12
102763BN	50.25	460	026508120910	12
102763WR	55.40	460	026508120941	12
102763ORB	57.10	460	026508100387	12
104414	57.30	663	026508081525	0
104421	56.45	539	026508074589	36
104451	180.55	640	026508199282	12
104463	180.55	464	026508324257	12
104464	180.55	464	026508324240	12
104465	180.55	464	026508204368	12
104466	180.55	464	026508267103	12
104540	42.65	649	026508245293	20
104541	37.35	649	026508245309	20
104542	51.95	649	026508245316	20
104543	57.30	649	026508245323	20
104544	63.95	649	026508245330	20
104545	70.60	649	026508245347	20
104546	37.35	649	026508245354	20
104547	41.35	649	026508245361	20
104548	44.00	649	026508245378	20
104549	47.95	649	026508245385	20
104550	53.35	649	026508245392	20
104551	57.30	649	026508245408	20
104552	63.95	649	026508245415	20
104553	67.95	649	026508245422	20
104554	73.25	649	026508245439	20
104555	128.35	646	026508246535	20
104556	128.35	646	026508244074	20
104557	22.45	649	026508244081	20
104560	49.85	649	026508247891	12
104561	70.35	649	026508246559	20
104563	94.60	649	026508245446	20
104564	94.60	649	026508246573	20
104565	94.60	649	026508245453	20
104566	94.60	649	026508245460	20
104567	94.60	649	026508245477	20
104568	94.60	649	026508245484	20
104569	28.45	649	026508245491	20
104570	21.00	646	026508245507	12
104571	28.05	646	026508246580	20
104572	7.30	649	026508245514	20
104573	27.15	649	026508246801	30
104574	59.30	649	026508246818	15
104575	53.20	649	026508248010	6
104577	12.75	649	026508246825	30
104578	53.60	646	026508244098	12
104579	58.15	646	026508244104	12
104580	53.70	646	026508244111	12
104581	37.50	646	026508244128	20
104582	34.15	646	026508246832	20
104583	29.40	646	026508246856	20
104584	87.35	646	026508247877	12
104585	137.60	646	026508247884	0
104587	167.70	646	026508248614	6
104588	31.55	646	026508246863	20
104589	50.75	646	026508246870	20
104590	30.15	649	026508247426	33
104591	30.15	649	026508247433	33
104592	30.15	649	026508247440	33
104593	30.15	649	026508247457	33
104594	30.15	649	026508247464	33
104595	30.15	649	026508247471	33
104597	20.15	649	026508246849	40
104598	29.70	649	026508251843	20
104599	53.35	649	026508251850	20
104600	57.25	649	026508252536	12
104609	11.65	649	026508251867	20
104617	34.00	646	026508273999	12
104618	80.40	646	026508274002	12

MODEL NUMBER	LIST PRICE	PAGE NO.	UNIVERSAL PRODUCT CODE	CASE QTY
104619	80.40	646	026508274019	12
104620	80.40	646	026508274026	12
104621	80.40	646	026508274033	12
104622	80.40	646	026508274040	12
104623	80.40	646	026508274057	12
104624	80.40	646	026508274064	12
104625	37.85	646	026508274071	12
104626	38.90	646	026508274088	12
104627	36.20	646	026508274095	12
104628	107.00	646	026508274101	12
104630	109.90	636	026508273609	12
104631	36.30	646	026508274118	12
104633	129.45	646	026508274125	12
104634	25.60	646	026508274132	20
105895	30.80	108	026508288542	6
105895NL	41.10	108	026508294338	6
105895BG	41.60	108	026508283608	6
105895BL	42.15	108	026508098011	6
105895SRS	42.50	108	026508214138	6
105895BLS	43.35	108	026508294499	6
105895ORB	44.40	108	026508144336	6
106378	22.50	548	026508085868	250
106479	5.45	549	026508085899	300
114348	115.35	451	026508118085	12
114348NL	134.15	451	026508146354	12
114348BN	167.25	451	026508118115	12
114348ORB	183.85	451	026508101766	12
114348WR	183.85	451	026508118122	12
116651	18.25	435	026508128572	6
116651BG	30.90	435	026508285572	6
116651BN	30.90	435	026508128589	6
116651NL	30.90	435	026508147146	6
116651ORB	40.15	435	026508147191	6
116651WR	40.15	435	026508128596	6
116711	8.20	544	026508135686	500
123815	35.95	435	026508140437	12
123815BG	59.90	435	026508285138	12
123815BN	59.90	435	026508152881	12
123815NL	59.90	435	026508301159	12
123815BL	65.90	435	026508279410	12
123815ORB	65.90	435	026508164983	12
123816	60.80	553	026508140444	12
123816BN	85.15	553	026508166994	12
123816BL	94.00	553	026508356722	12
123816ORB	94.00	553	026508167007	12
128284	36.25	450	026508156568	12
129102	42.50	548	026508173114	12
129102BG	62.65	548	026508293195	12
129102BN	62.65	548	026508173121	12
129102NL	62.65	548	026508173176	12
129102ORB	68.95	548	026508173152	12
129102WR	68.95	548	026508173145	12
130153	42.25	548	026508158500	12
130153BG	62.55	548	026508297650	12
130153BN	64.85	548	026508158517	12
130153NL	70.80	548	026508157244	12
130153ORB	71.30	548	026508158524	12
130153WR	71.30	548	026508158531	12
131553	86.45	553	026508157862	12
131553BN	117.95	553	026508200742	12
131553NL	117.95	553	026508230916	12
131553ORB	128.20	553	026508200759	12
131553BG	129.55	553	026508286616	12
131553BL	132.70	553	026508305096	12
135167	58.70	549	026508171677	9
135167BN	107.05	549	026508171318	9
135167WR	117.95	549	026508171325	9
137114	48.15	547	026508173275	20
137347	45.25	548	026508173565	9
137347NL	53.75	548	026508173596	9
137347P	72.15	548	026508173602	9
137347BG	73.70	548	026508293287	9
137347BN	73.70	548	026508173589	9
137347WR	81.00	548	026508173619	9
137401	15.70	545	026508180310	12
137488	10.85	437	026508178454	200
137488BG	28.20	437	026508285220	12
137488BN	28.20	437	026508178461	200
137488NL	28.20	437	026508309698	48
137488BL	29.75	437	026508277409	24
140676	6.50	542	026508184356	96
140680	18.05	460	026508184431	12
140690	20.35	460	026508184448	12
140715	12.70	464	026508187517	200
140780	76.80	146	026508165720	12

Wholesale

Listed in numerical order

MODEL NUMBER	LIST PRICE	PAGE NO.	UNIVERSAL PRODUCT CODE	CASE QTY	MODEL NUMBER	LIST PRICE	PAGE NO.	UNIVERSAL PRODUCT CODE	CASE QTY
140780BG	107.05	146	026508286623	12	161919	26.35	143	026508233283	20
140780BN	107.05	146	026508165737	12	161919BG	37.35	143	026508292891	20
140780NL	107.05	146	026508230923	12	161919BN	37.35	143	026508233290	20
140780BL	120.90	146	026508299371	12	161919NL	37.35	143	026508309704	20
140780ORB	128.75	146	026508165744	12	161951	122.50	436	026508233559	12
141002	56.60	63	026508187296	6	161951BG	165.70	436	026508285237	12
141002NL	61.60	63	026508265765	6	161951BN	165.70	436	026508233610	12
141002BG	64.95	63	026508283677	6	161951NL	165.70	436	026508299449	12
141002BL	64.95	63	026508229019	6	161951BL	182.25	436	026508299432	12
141002SRS	64.95	63	026508209370	6	161951ORB	182.25	436	026508233627	12
141002BLS	71.45	63	026508314159	6	161955	101.40	454	026508233726	6
141002ORB	71.60	95	026508211410	6	161955BG	157.15	454	026508285589	6
142538	7.15	460	026508188668	180	161955BN	157.15	454	026508233733	6
143326	14.55	545	026508199695	100	161955NL	157.15	454	026508299456	6
143530	10.60	546	026508193167	144	161955BL	162.20	454	026508371312	6
145058	21.05	550	026508190432	50	161955ORB	172.90	454	026508233740	6
145665	5.75	547	026508193044	120	163847	12.30	545	026508238264	100
147204	30.45	193	026508204450	12	164745	14.65	437	026508239247	20
147204BN	73.75	193	026508205136	12	164745BG	21.40	437	026508285244	20
147204BL	81.10	193	026508375136	12	164745BN	21.40	437	026508239254	20
147206	108.05	549	026508200544	12	164745NL	21.40	437	026508299463	20
147212	40.60	549	026508200605	12	164745ORB	27.80	437	026508239261	20
147556	160.15	193	026508204696	6	164927	96.70	445	026508241585	6
147556BN	234.85	193	026508205211	6	164927BG	118.00	445	026508351574	6
147556BL	258.35	193	026508375068	6	164927NL	132.50	445	026508299470	6
147572	15.60	437	026508204849	12	164927BN	140.10	445	026508241592	6
147572BG	22.75	437	026508350966	12	164927BL	141.75	445	026508351581	6
147572BN	22.75	437	026508205327	12	164927ORB	158.05	445	026508241608	6
147572BL	27.10	437	026508317457	12	164928	99.10	445	026508241615	6
147913	175.60	445	026508200513	6	164928BN	143.65	445	026508241622	6
147913BN	260.00	445	026508200520	6	164928BL	158.05	445	026508290194	6
148479	32.50	549	026508202975	25	164928ORB	158.05	445	026508241639	6
148479BN	60.80	549	026508202982	25	164929	83.00	446	026508241646	6
148479WR	61.20	549	026508202999	25	164929NL	120.10	446	026508271872	6
150257	46.95	542	026508205693	50	164929BN	120.40	446	026508241653	6
150627	34.25	543	026508213834	50	164929ORB	132.50	446	026508241660	6
151380	93.50	435	026508207413	6	165006	27.90	252	026508239926	20
151380BG	158.90	435	026508323687	6	165006BL	57.60	252	026508306482	20
151380BN	158.90	435	026508207420	6	165018	8.25	545	026508240120	12
151380BL	174.70	435	026508323694	6	165914	193.00	453	026508242339	6
151380ORB	174.70	435	026508207437	6	165914BN	327.20	453	026508242346	6
154289	8.55	544	026508218075	20	165914BL	359.95	453	026508308103	6
154296	364.50	448	026508218266	6	168665	32.30	546	026508239193	50
154296BG	379.40	448	026508291870	6	168666	20.50	546	026508244487	50
154296BN	400.80	448	026508218273	6	169031	156.45	61	026508266199	12
154296BL	440.90	448	026508328088	6	172656	96.10	454	026508251003	6
154296NL	440.90	448	026508231029	6	172656BG	145.95	454	026508285145	6
154296ORB	440.90	448	026508218280	6	172656BN	152.30	454	026508251010	6
154305	178.95	445	026508218488	6	172656BL	172.85	454	026508274675	6
154305BG	245.60	445	026508291887	6	172657	96.10	454	026508251027	6
154305BN	259.50	445	026508218495	6	172657BG	129.55	454	026508291931	6
154305BL	275.55	445	026508312643	6	172657BN	152.30	454	026508251034	6
154305NL	275.55	445	026508231098	6	172657BL	188.50	454	026508293379	6
154305ORB	275.55	445	026508218501	6	172666	19.10	240	026508250938	20
154364	8.25	544	026508213612	100	172666BG	23.70	240	026508292006	20
155656	41.90	447	026508219867	12	172666BN	23.70	240	026508250945	20
155694	32.05	451	026508221372	12	172666BL	33.35	240	026508280942	20
155694BG	46.35	451	026508337769	12	174055	34.05	642	026508235799	12
155694BN	46.35	451	026508221389	12	174056	108.15	642	026508235904	12
155694BL	51.00	451	026508337776	12	174057	30.05	642	026508235911	12
155694ORB	51.00	451	026508227565	12	174060	19.05	642	026508235942	12
155746	258.80	448	026508221396	6	174061	26.70	642	026508235959	12
155746BG	357.25	448	026508292853	6	174061BN	33.40	642	026508346433	12
155746BN	375.15	448	026508221402	6	174061BL	36.75	642	026508346426	12
155746ORB	412.70	448	026508227572	6	174062	9.85	642	026508252765	12
155747	83.00	446	026508221419	6	174065	54.00	642	026508252772	12
155747BG	109.10	446	026508293584	6	174066	6.25	642	026508252789	12
155747BN	120.40	446	026508221426	6	174335	213.65	642	026508254394	12
155747ORB	132.50	446	026508227589	6	174336	21.20	642	026508254400	20
155747NL	153.75	446	026508312674	6	174337	21.20	642	026508254417	20
155748BG	48.65	449	026508294314	8	174337BN	26.50	642	026508343852	20
155748NL	48.65	449	026508295007	8	174337BL	29.15	642	026508343845	20
155748	49.60	449	026508221433	8	175083	8.25	544	026508252895	200
155748BN	71.90	449	026508221440	8	175084	8.25	544	026508252901	350
155748BL	106.00	449	026508280775	8	175385	100.75	454	026508257753	6
155748BR	106.00	449	026508280782	8	175385BN	156.40	454	026508257760	6
155891	83.00	446	026508223178	24	175385NL	156.40	454	026508257777	6
155891BG	115.35	446	026508293591	6	175385ORB	171.95	454	026508257784	6
155891BN	115.35	446	026508223185	24	175709	127.20	547	026508254912	12
155891BL	132.50	446	026508278185	24	175916	17.05	641	026508261903	12
157276EP15	83.00	446	026508241714	6	175917	17.05	641	026508261910	1
159060	22.20	108	026508231425	6	175918	17.05	641	026508261927	12
160042	127.65	445	026508228166	6	175921	17.05	641	026508266755	12
160042BN	185.25	445	026508228173	6	175925	17.05	641	026508266762	12
160042ORB	203.75	445	026508228180	6	175926	17.05	641	026508266779	12

SUGGESTED LIST PRICES

Wholesale

Listed in numerical order

MODEL NUMBER	LIST PRICE	PAGE NO.	UNIVERSAL PRODUCT CODE	CASE QTY	MODEL NUMBER	LIST PRICE	PAGE NO.	UNIVERSAL PRODUCT CODE	CASE QTY
176257	120.10	445	026508254974	6	193371BL	125.40	457	026508372166	6
176257BN	176.10	445	026508254981	6	193371ORB	133.20	457	026508299944	6
177171	117.25	436	026508257876	12	195386	93.50	457	026508281208	6
177171BN	158.55	436	026508257883	12	195386BN	135.65	457	026508281215	6
177171NL	158.55	436	026508257890	12	195386NL	135.65	457	026508281222	6
177171ORB	174.45	436	026508257906	12	195386ORB	149.25	457	026508281239	6
177566	48.10	65	026508259719	6	195827	78.35	457	026508299951	6
178755	81.65	552	026508259030	8	195827BG	121.05	457	026508299968	6
178755BN	118.40	552	026508259047	8	195827BN	121.05	457	026508299982	6
178755ORB	125.70	552	026508259054	8	195827BL	133.20	457	026508299975	6
179573	76.75	366	026508274224	6	195957	75.70	446	026508305102	6
179791	121.75	454	026508264171	6	195957BN	109.80	446	026508305119	6
179791BN	154.90	454	026508264188	6	195957NL	109.80	446	026508305126	6
179791BL	170.40	454	026508326855	6	195957ORB	120.90	446	026508305133	6
179834	17.85	437	026508263969	20	195958	78.55	446	026508305140	6
179834BL	24.00	437	026508335499	20	195958BN	113.90	446	026508305157	6
180158	11.10	544	026508266458	20	195958NL	113.90	446	026508305164	6
181040	17.05	641	026508266786	12	195958ORB	125.05	446	026508305171	6
181148	79.80	636	026508274491	12	198017	99.05	448	026508315163	6
181148BN	99.75	636	026508343920	12	198017BN	143.60	448	026508315187	6
181148BL	107.75	636	026508343913	12	198017BL	152.50	448	026508315170	6
181149	69.05	636	026508274507	12	198020	109.05	445	026508315255	6
181149BN	86.30	636	026508343944	12	198020BN	158.10	445	026508315279	6
181149BL	93.20	636	026508343937	12	198020BL	173.95	445	026508315262	6
182413	62.00	642	026508272305	64	198021	109.05	445	026508315286	6
182414	17.50	642	026508272312	12	198021BN	158.10	445	026508315309	6
182415	127.85	642	026508272329	24	198021BL	173.95	445	026508315293	6
182416	105.80	642	026508272336	12	199785	58.60	59	026508328699	6
182417	52.15	642	026508272343	12	200755	45.25	547	026508329450	15
182418	36.40	642	026508272350	12	200755BG	73.70	547	026508331255	15
182419	17.65	642	026508272367	12	200755BN	73.70	547	026508331279	15
182420	46.35	642	026508272374	12	200755NL	73.70	547	026508331286	15
182421	67.20	642	026508272381	12	200755BL	80.90	547	026508331262	15
182422	165.35	642	026508272398	12	200760	62.90	547	026508329504	12
182534	55.80	642	026508273708	6	200763	5.75	549	026508329528	12
182535	150.30	642	026508273715	6	200779	45.25	547	026508331446	15
182536	10.65	642	026508273722	20	200779BG	73.70	547	026508331453	15
182537	165.35	642	026508273739	12	200779BN	73.70	547	026508331477	15
182538	23.40	636	026508273746	20	200779BL	73.70	547	026508331484	15
182540	56.60	642	026508273760	12	200779ORB	81.00	547	026508331460	15
182542	18.15	642	026508273777	20	200780	45.25	547	026508331507	15
182543	18.05	642	026508273784	20	200780BN	73.70	547	026508331514	15
182544	18.05	642	026508273791	20	200781	45.25	547	026508331521	15
182546	36.35	636	026508273807	12	200781BG	73.70	547	026508331538	15
182546BN	45.45	636	026508343951	12	200781BN	73.70	547	026508331545	15
182546BL	50.00	636	026508343692	12	200781NL	73.70	547	026508331552	15
182547	26.25	642	026508273814	20	200781ORB	81.00	547	026508331569	15
185820	119.45	453	026508276969	6	205497	11.25	129	026508269183	100
185820BN	142.55	453	026508276976	6	210007	59.65	449	026508353714	12
185820NL	142.55	453	026508299487	6	210007BN	83.05	449	026508353721	12
185820BL	149.30	453	026508372159	6	210007SRN	83.05	449	026508353738	12
185820ORB	151.75	453	026508276983	6	210007BG	122.45	449	026508353769	12
186117	25.75	444	026508284742	6	210007BL	122.45	449	026508353745	12
186117SRN	31.30	444	026508284759	6	21007ORB	122.45	449	026508353752	12
186117BN	38.70	444	026508329238	6	213293	19.10	218	-	12
186117BL	41.55	444	026508329221	6	213293BG	23.70	218	-	12
186117ORB	42.60	444	026508329252	6	213293BN	23.70	218	-	12
186589	9.95	129	026508275221	6	213293BL	33.35	218	-	12
187054BG	193.05	444	026508363218	6	216721	8.25	544	026508186374	700
187054	161.35	444	026508281147	6	221672	26.95	145	026508224519	12
187054BN	201.15	444	026508281154	6	221672BG	35.80	145	026508293140	12
187054BL	222.90	444	026508324745	6	221672BN	35.80	145	026508224526	12
187054ORB	222.90	444	026508281161	6	221672NL	35.80	145	026508231135	12
189315	70.55	446	026508282120	6	221672BL	39.60	145	026508301166	12
189315BN	95.25	446	026508282137	6	221672ORB	39.60	145	026508224533	12
189315BL	104.85	446	026508285459	6	221673	18.25	156	026508224540	12
189315ORB	104.85	446	026508282144	6	221673BG	24.35	156	026508293157	12
189318	78.55	446	026508282151	6	221673BN	24.35	156	026508224557	12
189318BN	113.90	446	026508282168	6	221673NL	24.35	156	026508231142	12
189318SRN	113.90	446	026508282199	6	221673BL	26.85	156	026508301173	12
189318BRB	125.45	446	026508282175	6	221673ORB	26.85	156	026508224564	12
189318ORB	125.45	446	026508282182	6	221772	17.30	147	026508256947	12
189575	113.60	445	026508282205	6	221772BN	22.95	147	026508256954	12
189575BG	166.65	445	026508304815	6	221772BG	24.25	147	026508336878	12
189575BN	166.65	445	026508282212	6	221772NL	24.25	147	026508336885	12
189575NL	166.65	445	026508304822	6	221772BL	24.40	147	026508301180	12
189575BL	183.40	445	026508337783	6	221772ORB	25.25	147	026508288290	12
191956	94.15	456	026508281178	6	226651	56.45	435	026508165751	6
191956BG	136.45	456	026508285152	6	226651BG	109.45	435	026508285596	6
191956BN	136.45	456	026508281185	6	226651BN	109.45	435	026508165782	6
191956NL	136.45	456	026508299494	6	226651NL	109.45	435	026508165799	6
191956BL	141.25	456	026508371329	6	226651ORB	120.35	435	026508165805	6
191956ORB	150.00	456	026508281192	6	226651WR	120.35	435	026508165829	6
193371	78.35	457	026508299913	6	262578	22.00	103	026508375044	12
193371BN	121.05	457	026508299920	6					

Wholesale

Listed in numerical order

SUGGESTED LIST PRICES

MODEL NUMBER	LIST PRICE	PAGE NO.	UNIVERSAL PRODUCT CODE	CASE QTY	MODEL NUMBER	LIST PRICE	PAGE NO.	UNIVERSAL PRODUCT CODE	CASE QTY
316711	8.25	544	026508178775	350	AT2099ORB	60.20	437	026508132173	12
316721	12.30	545	026508260883	100	AT2199	10.25	437	026508065136	200
336651	84.45	435	026508282229	6	AT2199BN	27.00	437	026508130162	200
336651BG	164.20	435	026508285169	6	AT2199NL	27.00	437	026508104057	48
336651BN	164.20	435	026508282243	6	AT2199BG	28.55	437	026508324271	48
336651NL	164.20	435	026508282250	6	AT2199ORB	29.65	437	026508132180	200
336651BL	180.45	435	026508282236	6	AT2199WR	29.65	437	026508118436	24
336651ORB	180.45	435	026508282267	6	BH3803CH	29.15	260	034584024848	12
416711	8.25	544	026508178782	200	BH3803BN	32.10	260	034584029058	24
516711	8.25	544	026508180464	500	BH3803BL	35.35	260	034584029041	24
A501	122.70	447	026508149119	12	BH3808CH	50.10	260	034584024855	3
A501BN	153.45	447	026508149300	12	BH3808BN	55.15	260	034584029072	6
A501NL	153.45	447	026508149171	12	BH3808BL	60.65	260	034584029065	6
A501ORB	168.75	447	026508149256	12	BH3818CH	50.50	260	034584024862	3
A501WR	168.75	447	026508149188	12	BH3818BN	55.55	260	034584029096	6
A701	61.60	452	026508232941	12	BH3818BL	61.10	260	034584029089	6
A701BG	89.10	452	026508335970	12	BH3824CH	54.80	260	034584024879	3
A701BN	89.10	452	026508232958	12	BH3824BN	60.25	260	034584029119	6
A701BL	98.05	452	026508335987	12	BH3824BL	66.25	260	034584029102	6
A701ORB	98.05	452	026508232965	12	BH3886CH	40.20	260	034584024886	3
A705	56.05	436	026508240816	12	BH3886BN	44.25	260	034584029133	6
A705CBN	84.05	436	026508240823	12	BH3886BL	48.60	260	034584029126	6
A714	56.15	451	026508042847	24	BP1803CH	19.75	485	034584030870	24
A714ORB	89.50	451	026508181317	12	BP1803BN	23.70	485	034584030863	24
A714WR	89.50	451	026508167014	12	BP1803BL	28.50	485	034584030856	24
A720	94.30	452	026508042892	12	BP1808CH	33.05	485	034584030900	6
A720BN	128.15	452	026508141984	12	BP1808BN	37.45	485	034584030894	6
A720BL	140.95	452	026508351291	12	BP1808BL	43.35	485	034584030887	6
A720ORB	140.95	452	026508141991	12	BP1818CH	43.25	485	034584030931	6
A721	84.55	439	026508227725	12	BP1818BN	49.45	485	034584030924	6
A721BG	119.25	439	026508282496	12	BP1818BL	62.30	485	034584030917	6
A721BN	119.25	439	026508227732	12	BP1822CH	73.50	485	034584030962	6
A721NL	119.25	439	026508301272	12	BP1822BN	81.55	485	034584030955	6
A721SRN	119.25	441	026508282465	12	BP1822BL	105.90	485	034584030948	6
A721BL	131.15	450	026508335994	12	BP1824CH	47.00	485	034584030993	6
A721ORB	131.15	450	026508282472	12	BP1824BN	54.40	485	034584030986	6
A723	32.65	663	026508228654	20	BP1824BL	67.60	485	034584030979	6
A725	66.10	439	026508044551	12	BP1886CH	24.75	485	034584031020	6
A725CBN	86.85	663	026508191224	12	BP1886BN	29.65	485	034584031013	6
A725BN	93.60	439	026508121955	12	BP1886BL	34.60	485	034584031006	6
A725NL	93.60	439	026508079232	12	BP1888CH	42.45	485	034584031051	6
A725BG	98.85	439	026508285275	12	BP1888BN	50.95	485	034584031044	6
A725ORB	102.90	439	026508132166	12	BP1888BL	61.15	485	034584031037	6
A725WR	102.90	439	026508121962	12	BP1892CH	247.10	485	034584037442	1
A726	134.25	119	026508073032	12	BP1892BN	296.50	485	034584037435	1
A726WR	152.95	449	026508118412	6	BP1892BL	355.85	485	034584037428	1
A726BG	239.80	449	026508285367	12	BP3703CH	29.85	488	034584025418	24
A726NL	239.80	449	026508079638	24	BP3703BN	33.65	488	034584025401	24
A726SRN	239.80	449	026508282458	12	BP3708CH	43.35	488	034584025432	6
A726ST	239.80	449	026508079645	12	BP3708BN	48.75	488	034584025425	6
A726BR	248.50	449	026508181225	12	BP3718CH	56.85	488	034584025456	6
A735	208.70	448	026508172728	6	BP3718BN	63.90	488	034584025449	6
A735BG	270.85	448	026508294307	6	BP3724CH	59.45	488	034584025470	6
A735NL	296.85	448	026508313374	6	BP3724BN	69.55	488	034584025463	6
A735BN	302.60	448	026508172735	6	BP3786CH	46.05	488	034584025494	6
A735ORB	321.15	448	026508172742	6	BP3786BN	51.75	488	034584025487	6
A735WR	321.15	448	026508172766	6	BP5808CH	14.40	492	034584007384	6
A742	225.65	448	026508204078	6	BP5824CH	16.60	492	034584007391	6
A742BG	290.10	448	026508282441	6	BP5886CH	11.35	492	034584007407	6
A742NL	309.60	448	026508301289	6	BP6903CH	12.30	490	034584020215	24
A742BN	327.35	448	026508205433	6	BP6903ORB	18.65	490	034584012517	24
A742BL	360.10	448	026508351284	6	BP6908CH	27.15	490	034584484093	6
A742BRB	360.10	448	026508282434	6	BP6908ORB	36.60	490	034584012524	6
A742ORB	360.10	448	026508282427	6	BP6908PW	36.65	490	034584484178	6
A750	41.65	439	026508172674	24	BP6918CH	28.40	490	034584484079	6
A755	169.00	450	026508232972	12	BP6918ORB	35.50	490	034584012531	6
A755BG	245.15	450	026508351376	12	BP6924CH	31.30	490	034584484086	6
A755BN	245.15	450	026508232989	12	BP6924ORB	41.35	490	034584012548	6
A755BL	269.70	450	026508351369	12	BP6924PW	41.35	490	034584484161	6
A755ORB	269.70	450	026508232996	12	BP6980CH	22.80	490	034584014658	6
A780	158.35	118	026508227138	20	BP6980ORB	27.60	490	034584014665	6
A1717	175.40	310	026508166116	6	BP6986CH	20.45	490	034584484109	6
A1717BN	251.30	310	026508166123	6	BP6986PW	25.55	490	034584484185	6
A1717ORB	273.10	310	026508199015	6	BP6986ORB	25.60	490	034584012555	6
ARC-4200	66.75	129	029122010520	60	BR587	4.90	501	034584701183	72
ARC-4200-CH/SN	87.60	129	029122010711	6	CA8301	623.50	642	026508211076	3
AS-4201-CH	22.45	129	029122010681	100	CA8301BN	779.40	636	026508343814	3
AS-4201-BL	28.05	129	026508294369	100	CA8301BL	841.75	636	026508343807	3
AS-4201-BRB	33.90	129	026508251706	100	CA8302	615.25	642	026508211083	6
AS-4201-NL	33.90	129	026508294376	100	CA8302BN	769.05	636	026508343838	6
AS-4201-BLS	39.85	129	026508294574	100	CA8302BL	830.60	636	026508343821	6
AS-4201-BG	44.85	129	026508292075	100	CA8303	693.80	642	026508211090	3
AS-4201-SN	44.85	129	029122010674	100	CL703	104.95	452	026508250549	12
AT2099	21.55	437	026508065112	12	CL703BN	152.10	452	026508250556	12
AT2099BN	54.80	437	026508105924	12	CL703BL	167.40	452	026508351345	12

Wholesale

Listed in numerical order

MODEL NUMBER	LIST PRICE	PAGE NO.	UNIVERSAL PRODUCT CODE	CASE QTY	MODEL NUMBER	LIST PRICE	PAGE NO.	UNIVERSAL PRODUCT CODE	CASE QTY
CL7030RB	167.40	452	026508250563	12	DN0724BN	58.00	340	034584012937	3
CL707	142.50	452	026508250570	12	DN0724BL	63.80	340	034584034182	3
CL707BN	206.55	452	026508250587	12	DN0761CH	146.85	341	034584018632	2
CL707BL	227.25	452	026508351307	12	DN0761BL	177.90	341	034584029867	2
CL707ORB	227.25	452	026508250594	12	DN0761BN	184.90	341	034584018625	2
CL6302	114.75	433	026508254240	12	DN0761BG	221.85	341	034584028549	2
CL6302EP	114.75	433	026508266892	12	DN0762CH	209.50	341	034584018656	2
CL6302BN	179.10	433	026508254257	12	DN0762BL	253.75	341	034584029874	2
CL6302EPBN	179.10	433	026508266908	12	DN0762BN	258.90	341	034584018649	2
CL6303	63.45	434	026508254264	12	DN0762BG	310.60	341	034584028532	2
CL6303EP	63.45	434	026508266878	12	DN0763CH	257.10	341	034584018670	2
CL6303BN	97.20	434	026508254271	12	DN0763BL	311.35	341	034584029881	2
CL6303EPBN	97.20	434	026508266885	12	DN0763BN	321.45	341	034584018663	2
CL10154	36.80	435	026508254103	12	DN0763BG	385.70	341	034584028525	2
CL10154BN	74.35	435	026508254110	12	DN0764CH	329.35	341	034584018694	2
CL26500	67.60	434	026508254226	12	DN0764BL	398.85	341	034584029898	2
CL26500EP	67.60	434	026508266915	12	DN0764BN	411.55	341	034584018687	2
CL26500BN	110.30	434	026508254233	12	DN0764BG	493.85	341	034584028518	2
CL26500EPBN	110.30	434	026508266922	12	DN0769	27.10	341	034584019097	3
CL123815	46.05	435	026508254127	12	DN0786CH	32.45	340	034584008312	3
CL123815BN	86.90	435	026508254134	12	DN0786BL	39.40	340	034584012982	3
CL155694	30.35	451	026508254141	12	DN0786BL	43.40	340	034584034199	3
CL155694BN	43.85	451	026508254158	12	DN0790CH	90.65	340	034584008329	3
CL155747	78.55	446	026508254776	6	DN0790BN	102.05	340	034584012999	3
CL155747BN	113.90	446	026508254783	6	DN0790BL	112.25	340	034584034205	3
CL155748	46.90	449	026508254165	12	DN0792CH	121.30	340	034584008336	3
CL155748BN	68.05	449	026508254172	12	DN0792BN	136.50	340	034584013101	3
CL164928	93.80	445	026508254202	6	DN0792BL	150.15	340	034584034212	3
CL164928BN	136.05	445	026508254219	6	DN0794CH	212.20	340	034584015167	2
CLA701	61.60	452	026508254288	12	DN0794BN	229.45	340	034584015174	2
CLA701BN	89.10	452	026508254295	12	DN0794BL	252.40	340	034584034229	2
CSR2145CH	54.40	506	034584023407	10	DN0892ORB	119.65	494	034584037459	3
CSR2145BN	63.50	506	034584023391	10	DN2141CH	83.80	504	034584017536	2
CSR2155CH	59.35	506	034584023421	10	DN2141BN	84.50	504	034584017543	2
CSR2155BN	63.35	506	034584023414	10	DN2141OWB	106.30	504	034584017550	2
CSR2155OWB	74.85	506	034584023438	10	DN2141BL	109.00	504	034584029904	6
CSR2160CH	66.65	505	034584008831	10	DN2141NL	176.05	504	034584029911	6
CSR2160BN	67.90	505	034584008848	10	DN2692CH	102.05	494	034584037473	3
CSR2160OWB	83.85	505	034584008855	10	DN2692BN	106.90	494	034584037466	3
CSR2160BG	97.90	505	034584028587	10	DN5075	23.55	501	034584014856	3
CSR2160BL	100.05	505	034584029805	10	DN5075W	23.55	501	034584014863	3
CSR2160NL	133.40	505	034584029812	10	DN6801CH	21.85	486	034584001139	3
CSR2164CH	68.15	505	034584024374	10	DN6801BN	33.20	486	034584001146	12
CSR2164BN	75.00	505	034584024381	10	DN6801ORB	36.60	486	034584009333	12
CSR2164OWB	85.75	505	034584024398	10	DN6803CH	13.60	486	034584483300	3
CSR2164BL	102.30	505	034584029829	10	DN6803BN	22.25	486	034584483317	12
CSR2164BG	104.90	505	034584028570	10	DN6803ORB	22.50	486	034584015983	12
CSR2164NL	136.40	505	034584029836	10	DN6808CH	25.95	486	034584483324	3
CSR2165CH	52.70	506	034584008794	10	DN6808BN	34.60	486	034584483331	3
CSR2165BN	56.45	506	034584008800	10	DN6808ORB	38.25	486	034584015990	3
CSR2165OWB	67.80	506	034584011336	10	DN6818CH	30.35	486	034584483348	3
CSR2166CH	60.30	506	034584008817	10	DN6818BN	40.90	486	034584483355	3
CSR2166BN	64.85	506	034584008824	10	DN6818ORB	42.50	486	034584016003	3
CSR2167CH	51.80	506	034584031112	10	DN6822BN	67.50	486	034584002297	3
CSR2167BN	60.45	506	034584031105	10	DN6824CH	32.95	486	034584483362	3
CSR2167BL	74.65	506	034584031099	10	DN6824BN	44.40	486	034584483379	3
CSR2168CH	63.45	505	034584031143	10	DN6824ORB	46.20	486	034584016010	3
CSR2168BN	69.90	505	034584031136	10	DN6850BN	66.00	486	034584483416	2
CSR2168BL	91.35	505	034584031129	10	DN6886CH	21.45	486	034584483386	3
CSR2172CH	61.70	507	034584023018	10	DN6886BN	31.00	486	034584483393	3
CSR2172BN	67.90	507	034584023001	10	DN6886ORB	31.35	486	034584016027	3
DN0703CH	25.40	340	034584008268	12	DN6890BN	65.60	486	034584485564	3
DN0703BN	28.55	340	034584012890	12	DN6892BN	127.35	486	034584002235	3
DN0703BL	31.45	340	034584034373	24	DN6903PW	18.50	490	034584190819	24
DN0705CH	10.95	340	034584018489	48	DN6918PW	34.50	490	034584190833	3
DN0705BN	12.80	340	034584018472	48	DN7005	46.10	533	034584179623	2
DN0705BL	13.30	340	034584029843	48	DN7010	37.30	533	034584179630	2
DN0705BG	15.35	340	034584028563	48	DN7015	45.05	533	034584179647	2
DN0707CH	21.85	340	034584018496	48	DN7020	42.70	533	034584179654	2
DN0707BN	23.55	340	034584018144	48	DN7025	61.20	532	034584179661	2
DN0707BL	26.40	340	034584029850	48	DN7030	78.00	532	034584179678	2
DN0707BG	28.20	340	034584028556	48	DN7050	19.45	533	034584179715	24
DN0708CH	50.00	340	034584008275	3	DN7060	102.00	532	034584484277	2
DN0708BN	56.30	340	034584012906	3	DN7075	102.30	533	034584484307	2
DN0708BL	61.95	340	034584034380	3	DN7100	137.30	532	034584011923	2
DN0709CH	45.95	340	034584017314	3	DN7105	176.55	532	034584011947	2
DN0709BN	51.40	340	034584017307	3	DN7110	477.65	532	034584019141	2
DN0709BL	56.55	340	034584034397	3	DN7110OWB	554.15	532	034584023827	2
DN0718CH	46.00	340	034584008282	3	DN7175	72.15	533	034584011916	2
DN0718BN	53.25	340	034584012913	3	DN7703CH	15.55	489	034584004154	24
DN0718BL	58.55	340	034584034168	3	DN7703BN	18.05	489	034584004215	24
DN0722CH	75.00	340	034584008299	3	DN7708CH	28.85	489	034584004161	3
DN0722BN	84.15	340	034584012920	3	DN7708BN	33.10	489	034584004222	3
DN0722BL	92.60	340	034584034175	3	DN7718CH	30.40	489	034584004178	3
DN0724CH	50.00	340	034584008305	3	DN7718BN	34.95	489	034584004239	3

Wholesale

Listed in numerical order

SUGGESTED LIST PRICES

MODEL NUMBER	LIST PRICE	PAGE NO.	UNIVERSAL PRODUCT CODE	CASE QTY	MODEL NUMBER	LIST PRICE	PAGE NO.	UNIVERSAL PRODUCT CODE	CASE QTY
DN7722CH	47.95	489	034584004864	3	F9940	74.95	104	-	12
DN7722BN	55.10	489	034584004871	3	F26610SRS	99.95	105	-	6
DN7724CH	33.00	489	034584004185	3	F26620CH	89.95	105	-	6
DN7724BN	38.00	489	034584004246	3	F26620SRS	99.95	105	-	6
DN7786CH	21.60	489	034584004192	3	F26620BL	105.95	105	-	6
DN7786BN	24.80	489	034584004253	3	F26660SRS	99.95	105	-	6
DN7790CH	52.00	489	034584004208	3	F26660BL	105.95	105	-	6
DN7790BN	59.85	489	034584004260	3	FC301810	895.30	112	026508334744	1
DN8001W	57.25	533	034584025319	3	FC331910	970.90	112	026508334751	1
DN8001CH	63.45	533	034584011701	3	FP62300	145.15	467	026508154502	12
DN8303CH	17.70	483	034584004413	24	FP62320	145.15	467	026508154496	12
DN8303BN	19.85	483	034584004482	24	FP62325PF	158.15	469	026508312377	12
DN8308CH	33.95	483	034584004420	3	FP62326PF	189.45	469	026508312384	12
DN8308BN	37.85	483	034584004499	3	FP62327PF	158.15	469	026508312391	12
DN8318CH	34.70	483	034584004437	3	FP62328PF	189.45	469	026508312407	12
DN8318BN	38.80	483	034584004505	3	FP62340	161.05	469	026508199213	12
DN8322CH	57.35	483	034584004444	3	FP62360PF	196.55	470	026508312414	12
DN8322BN	64.05	483	034584004512	3	FP62365	145.15	468	026508233580	12
DN8324CH	37.65	483	034584004451	3	FP62365PF	165.35	470	026508312421	12
DN8324BN	42.10	483	034584004529	3	FP62370	176.45	467	026508154519	12
DN8386CH	24.50	483	034584004468	3	FP62380	145.15	468	026508154526	12
DN8386BN	27.40	483	034584004536	3	FP62380PF	165.35	470	026508312438	12
DN8390CH	64.05	483	034584004475	3	FP62385	176.45	468	026508264713	12
DN8390BN	71.40	483	034584004543	3	FP62385PF	196.55	470	026508312445	12
DN8403CH	9.05	491	034584141118	12	FS7235	780.70	75	026508344569	3
DN8403BN	13.50	491	034584002242	12	FS7235SRS	975.90	75	026508344583	3
DN8403BL	16.70	491	026508363409	12	FS7235BL	1,014.95	75	026508344576	3
DN8408CH	19.30	491	034584141125	3	FS72003	765.55	76	026508375181	3
DN8408BN	26.60	491	034584002259	3	FS72003SRS	956.95	76	026508344552	3
DN8408BL	29.00	491	026508363416	3	FS72003BL	995.25	76	026508344545	3
DN8418CH	25.15	491	034584141132	3	FS73004	784.40	73	026508375211	3
DN8418BN	31.15	491	034584002266	3	FS73004SRS	980.50	73	026508344538	3
DN8418BL	33.95	491	026508363423	3	FS73004NL	1,058.90	73	026508344514	3
DN8422CH	41.50	491	034584141187	3	FS73004ORB	1,098.15	73	026508344521	3
DN8424CH	26.95	491	034584141149	1	FS73004BG	1,137.35	73	026508344507	3
DN8424BN	33.20	491	034584002273	3	G16100	841.30	116	026508240267	1
DN8424BL	36.20	491	026508363430	3	G16200	819.70	116	026508240274	1
DN8486CH	17.30	491	034584141156	3	G16221	862.90	116	026508240281	1
DN8486BN	22.35	491	034584002280	3	G16430	517.30	116	026508240298	1
DN8486BL	24.35	491	026508363454	3	G18121	884.50	118	026508248447	1
DN8490CH	45.40	491	034584481849	3	G18180	571.50	118	026508248119	1
DN8712	29.60	528	034584178275	6	G18185	442.80	118	026508248140	1
DN8948	64.50	529	034584175601	6	G18220	1,036.20	117	026508248454	1
DN9830CH	6.00	502	034584005885	50	G18287	571.50	117	026508248157	1
DN9830BC	7.60	502	034584005908	50	G18288	646.90	117	026508248164	1
DN9830BL	9.00	502	034584029928	50	GA716	112.80	119	026508248027	10
DN9830SN	9.90	502	034584005915	50	GA719	163.00	119	026508248034	6
DN9830BN	10.55	502	034584005892	50	GA726	79.30	119	026508248041	15
DN9830ORB	11.45	502	034584005922	50	GA728	107.00	119	026508248058	12
DN9830NL	15.00	502	034584029935	50	GA749B	170.45	120	026508248201	6
EB500-E	144.00	134	026508358269	5	GA760	190.70	116	026508248218	3
EB500-R	144.00	134	026508358276	5	GA763	140.95	116	026508248225	6
EB800-E	305.30	134	026508358283	1	GA768	166.35	116	026508248232	10
EB1000	438.70	134	026508337127	1	GA771	183.25	118	026508248249	6
EB1500-E	613.85	133	026508358238	1	GA772	140.40	117	026508248256	12
EB1500-EBS	706.20	133	026508358245	1	GA780B	186.30	118	026508248263	6
EB2100-E	844.60	133	026508358252	1	GA781B	166.35	118	026508248270	8
ET900	1,921.55	135	026508358306	1	GA782B	140.95	117	026508248287	15
ET1300	3,536.95	135	026508358290	1	GA785B	153.80	117	026508248294	6
ET2200	5,229.25	135	026508337158	1	GA821	103.80	121	026508248331	10
EXL100c	507.30	125	026508295670	2	GA841	140.40	121	026508248348	10
F5923	763.90	80	026508344415	3	GGA50B	137.85	114	026508307328	9
F5923SRS	954.85	80	026508344446	3	GGA51B	175.25	113	026508307335	10
F5923BL	993.05	80	026508344439	3	GGA52B	190.55	113	026508307342	9
F5923BG	1,107.65	80	026508344422	3	GGA55B	150.95	113	026508307373	10
F7600	199.95	101	026508359815	6	GGA57B	143.60	120	026508307397	9
F7600SRS	249.95	101	026508359822	6	GGA60B	83.85	121	026508307427	56
F7600BL	259.95	101	026508376584	6	GGA60W	83.85	121	026508307458	56
F7620	199.95	101	026508359839	6	GGA61B	96.95	122	026508307465	72
F7620SRS	249.95	101	026508359853	6	GGA61W	96.95	122	026508307496	72
F7620BL	259.95	101	026508359846	6	GGB3018B	382.65	114	026508307502	1
F7660	199.95	101	026508376355	6	GGB3019B	521.70	113	026508307519	1
F7660SRS	249.95	101	026508359877	6	GGB3024B	878.15	113	026508307526	1
F7660BL	259.95	101	026508359860	6	GGB3026B	703.50	113	026508307533	1
F9126	657.30	81	026508375570	3	GGB3028B	641.10	113	026508307557	1
F9126SRS	821.65	81	026508344491	3	GGB4010B	662.40	113	026508309353	1
F9126BL	854.50	81	026508344484	3	GGB4012B	645.25	113	026508309360	1
F9800	211.95	101	026508346419	2	GGW3018B	382.65	114	026508307717	1
F9805	100.70	105	026508365953	6	GGW3019B	521.70	113	026508307724	1
F9810	53.30	104	026508359884	12	GGW3024B	878.15	113	026508307731	1
F9820	93.30	103	026508359891	12	GGW3026B	703.50	113	026508307748	1
F9900	539.95	101	026508373132	1	GGW3028B	641.10	113	026508307762	1
F9910	74.95	104	026508373095	12	GGW4010B	662.40	113	026508309445	1
F9920	74.95	104	026508373118	12	GGW4012B	645.25	113	026508309452	1
F9930	139.95	104	026508373125	12	GS181020BUX	1,075.00	115	026508365939	1

Wholesale

Listed in numerical order

MODEL NUMBER	LIST PRICE	PAGE NO.	UNIVERSAL PRODUCT CODE	CASE QTY	MODEL NUMBER	LIST PRICE	PAGE NO.	UNIVERSAL PRODUCT CODE	CASE QTY
GS181050BUX	1,425.00	115	026508365878	1	N207C0BLC	575.90	413	026508324035	2
GS181062B	750.00	118	026508365915	1	N207C0BL	669.35	413	026508324028	2
GS181092B	975.00	118	026508365922	1	N400ROCH	231.10	431	026508346037	2
GS181210B	514.35	118	026508357637	1	N400H0CH	245.60	444	026508345962	2
GS182040BUX	1,350.00	115	026508368268	1	N400R0BG	303.75	431	026508346013	2
GS182072B	750.00	117	026508365892	1	N400ROBN	303.75	431	026508346143	2
GS182082B	850.00	117	026508365885	1	N400H0BG	318.30	444	026508345979	2
GT33c	137.25	127	026508290453	2	N400H0BN	318.30	444	026508345993	2
GT50c	165.15	127	026508290460	2	N400ROBL	332.80	431	026508346020	2
GX50c	191.95	126	026508261798	2	N400R0ORB	332.80	431	026508346044	2
GX100c	415.20	126	026508277720	1	N400H0BL	361.90	444	026508345986	2
GXB75c	356.85	126	026508274453	2	N400H0ORB	361.90	444	026508346006	2
GXP33c	126.40	128	026508261811	2	P1700	15.70	498	034584751904	100
GXP50c	148.70	128	026508261804	2	P1703	7.25	498	034584751805	100
GXS75c	266.40	126	026508261781	2	P1718	18.35	498	034584029171	50
IN208C2	323.00	443	026508323496	2	P1724	19.20	498	034584029188	50
IN208C2SRN	339.25	443	026508323502	2	P1780	16.40	498	034584751409	50
INC20801	25.95	443	3760094160819	6	P1786	12.55	498	034584751706	100
INC20802	25.95	443	3760094160826	6	P5030	2.60	497	034584090300	100
INC20803	25.95	443	3760094160833	6	P5030BN	5.10	497	034584027481	100
INC20804	25.95	443	3760094160840	6	P5050	5.15	497	034584090454	100
L2352	197.30	356	026508047538	6	P5050BN	11.70	497	034584027498	100
L2353	225.35	354	026508047569	6	P5080	4.35	497	034584090317	100
L2361	214.80	357	026508047613	6	P5080BN	9.60	497	034584027504	100
L2362	229.30	356	026508047545	6	P5100	4.30	497	034584090478	100
L2363	257.55	354	026508047583	6	P5118	5.85	497	034584090324	50
L2368EP	285.20	356	026508241813	3	P5118BN	12.70	497	034584027511	36
L2369EP	307.70	354	026508241820	3	P5124	6.60	497	034584090331	50
L4601	172.25	350	026508047293	12	P5124BN	14.05	497	034584027528	36
L4605	172.25	350	026508060759	12	P5130BN	15.15	497	034584027535	36
L4621	212.80	350	026508047286	12	P5340	3.25	497	034584090348	100
L4625	212.80	350	026508047323	12	P5360	3.85	497	034584090355	100
L64600	151.80	594	026508063705	12	P5500	4.55	497	034584090362	100
L64601	151.80	594	026508063712	12	P5860	5.40	497	034584090379	100
L64620	198.00	595	026508047309	12	P5860BN	10.15	497	034584027542	100
L64621	186.55	595	026508047316	12	P26100EP	69.80	444	026508266540	12
L64624	203.70	595	026508047347	12	R2250	18.80	531	034584094452	6
L64625	188.45	595	026508047354	12	R2260	22.65	531	034584094469	6
L64635	203.70	595	026508061534	12	R2270	26.85	531	034584094476	6
LR2250DCH	26.70	531	034584009005	3	R2356DBN	77.05	531	034584025258	3
LR2350DCH	71.95	531	034584020857	3	R5519	54.40	500	034584700544	10
LR2350DBN	74.80	531	034584017598	3	R7418	22.25	530	034584174185	6
LR2352DBN	69.20	531	034584017604	3	R7424	25.30	530	034584174246	6
LR2352DCH	71.95	531	034584020871	3	R7436	35.25	530	034584174369	6
LR2354DCH	71.95	531	034584020918	3	R7442	38.15	530	034584174420	6
LR2354DBN	74.80	531	034584020550	3	R8712P	27.95	528	034584094889	6
LR2356DCH	71.95	531	034584020895	3	R8712W	39.10	528	034584017826	6
LR7518	29.60	530	034584485397	3	R8712D3GCH	57.25	527	034584020017	6
LR7524	33.75	530	034584485403	3	R8712D3GBN	62.70	527	034584020000	6
LR7536	42.65	530	034584485410	3	R8712D3GOWB	75.20	527	034584020024	6
LR7542	47.45	530	034584485427	3	R8716P	31.20	528	034584017833	6
LR8716D3CH	39.90	526	034584005236	3	R8716W	45.05	528	034584017840	6
LR8716D3BN	44.75	526	034584005212	3	R8716D1GCH	64.40	526	034584025289	3
LR8716D3GCH	63.00	527	034584005311	3	R8716D1GBN	69.65	526	034584025272	3
LR8716D3GBN	64.40	527	034584005298	3	R8718P	32.95	528	034584094896	6
LR8716D3GOWB	76.20	527	034584007780	3	R8718PS	42.45	528	034584172273	6
LR8724D2CH	46.90	526	034584005205	3	R8718W	47.25	528	034584171870	6
LR8724D3CH	46.95	526	034584005243	3	R8718D3GCH	62.75	527	034584020048	6
LR8724PS	50.85	528	034584000798	3	R8718D3GBN	71.25	527	034584020031	6
LR8724D3BN	52.15	526	034584005229	3	R8718PB	83.40	528	034584177186	6
LR8724D2BN	52.20	526	034584005182	3	R8718D3GOWB	83.95	527	034584020055	6
LR8724D3GCH	69.00	527	034584005328	3	R8724P	37.55	528	034584094902	6
LR8724D1GCH	69.65	526	034584005281	3	R8724PS	46.50	528	034584172259	6
LR8724D1GBN	73.05	526	034584005267	3	R8724W	51.30	528	034584172242	6
LR8724D3GBN	75.20	527	034584005304	3	R8724PB	99.70	528	034584178244	6
LR8724D1GOWB	86.85	526	034584007773	3	R8730P	44.45	528	034584094919	6
LR8724D3GOWB	89.10	527	034584007797	3	R8730W	56.45	528	034584014917	6
MANCIS	58.55	459	026508355633	12	R8732P	42.45	528	034584014955	6
MANCXS	58.55	459	026508356913	12	R8732W	58.15	528	034584015181	6
MANXS	58.55	459	026508356920	12	R8736P	50.35	528	034584094926	6
MBHG3818CH	141.40	260	034584030078	3	R8736PS	54.85	528	034584172280	6
MBHG3818BN	147.15	260	034584030061	3	R8736W	62.95	528	034584094872	6
N207Z0GLC	31.70	413	026508324097	6	R8736D3GCH	104.55	527	034584009043	6
N207Z0SRN	33.70	413	026508324103	6	R8736D3GBN	105.55	527	034584009050	6
N207Z0BL	35.50	413	026508324080	6	R8736D3GOWB	124.85	527	034584016256	6
N207H0CH	110.30	413	026508318096	2	R8742P	54.10	528	034584094933	6
N207H0SRN	138.40	413	026508318102	2	R8742PS	67.10	528	034584172297	6
N207H0BLC	147.75	413	026508324066	2	R8742W	69.30	528	034584014962	6
N207H0BL	185.10	413	026508318089	2	R8742D3GCH	126.70	527	034584009067	6
N207R0CH	372.05	413	026508318126	2	R8742D3GBN	127.95	527	034584009074	6
N207R0SRN	420.70	413	026508318133	2	R8742D3GOWB	149.95	527	034584016263	6
N207R0BLC	428.15	413	026508324073	2	R8748P	63.95	528	034584482594	6
N207C0CH	482.40	413	026508324042	2	R8748W	70.75	528	034584014979	6
N207R0BL	484.25	413	026508318119	2	R8748D3GCH	144.40	527	034584020079	6
N207C0SRN	559.05	413	026508324059	2	R8748D3GBN	146.55	527	034584020062	6

MODEL NUMBER	LIST PRICE	PAGE NO.	UNIVERSAL PRODUCT CODE	CASE QTY	MODEL NUMBER	LIST PRICE	PAGE NO.	UNIVERSAL PRODUCT CODE	CASE QTY
R8748D3GOWB	170.85	527	034584020086	6	S176	254.10	430	026508139189	3
R8912P	32.50	529	034584094940	6	S176EP	254.10	430	026508214558	3
R8912W	48.75	529	034584485571	6	S176BG	349.35	430	026508285190	3
R8916P	32.95	529	034584017857	6	S176BN	349.35	430	026508152911	3
R8916	34.15	529	034584017888	6	S176EPBG	349.35	430	026508286012	3
R8918	37.55	529	034584176011	6	S176EPBN	349.35	430	026508214565	3
R8918P	39.20	529	034584094438	6	S176BL	366.80	430	026508279335	3
R8918W	59.85	529	034584171924	6	S176EPBL	366.80	430	026508279342	3
R8924	42.45	529	034584176028	6	S177	61.35	436	026508223550	6
R8924P	44.45	529	034584094445	6	S177BN	127.05	436	026508223574	6
R8924W	64.85	529	034584176059	6	S178	251.10	431	026508374757	3
R8930	45.75	529	034584014986	6	S178EP	251.10	431	026508374719	3
R8930P	48.15	529	034584094957	6	S178BG	349.35	431	026508374764	3
R8930W	64.85	529	034584014993	6	S178BN	349.35	431	026508374788	3
R8932	45.70	529	034584015006	6	S178EPBG	349.35	431	026508374726	3
R8932P	48.20	529	034584015020	6	S178EPBN	349.35	431	026508374740	3
R8932W	70.05	529	034584015013	6	S178BL	366.80	431	026508374771	3
R8936	52.05	529	034584176035	6	S178EPBL	366.80	431	026508374733	3
R8936P	55.30	529	034584481047	6	S664	1,109.60	91	026508200063	3
R8936W	74.05	529	034584176073	6	S664SRS	1,387.05	91	026508234242	3
R8942P	59.55	529	034584481054	6	S664BL	1,442.50	91	026508289525	3
R8942W	86.30	529	034584176097	6	S664NL	1,498.00	91	026508294352	3
R8948P	61.35	529	034584482587	6	S664ORB	1,553.45	91	026508169032	3
R8948W	88.95	529	034584092533	6	S664BG	1,608.95	91	026508283967	3
R8960FDW	173.90	530	034584016607	2	S665	1,109.60	91	026508205617	3
R8960FD	177.35	530	034584016584	2	S665SRS	1,387.05	91	026508234259	3
R8962FDW	192.70	530	034584016614	2	S665BL	1,442.50	91	026508289532	3
R8962FD	202.95	530	034584016591	2	S665BG	1,608.95	91	026508283974	3
RA8716D1GBN	79.60	526	034584025296	3	S665BLS	1,608.95	91	026508294635	3
RR5506HD	27.45	500	034584115263	60	S905	2,246.60	194	026508298480	1
RR5506HDOWB	32.65	500	034584024558	60	S905BN	3,032.85	194	026508298497	1
RR5520SS	22.90	500	034584700551	24	S905BL	3,032.90	194	026508370926	1
S0000	55.35	624	026508181461	12	S931	2,191.75	170	026508302484	1
S0001	66.55	624	026508025314	12	S931BG	2,958.80	170	026508302491	1
S0002	67.95	624	026508025321	12	S931BN	2,958.80	170	026508302507	1
S0003	66.55	624	026508025338	12	S931NL	2,958.80	170	026508302514	1
S0004	79.95	624	026508025345	12	S989	279.70	453	026508302521	6
S0007	67.95	624	026508025376	12	S989BG	419.60	453	026508302538	6
S0009	73.25	624	026508025390	12	S989BN	419.60	453	026508302545	6
S0010	79.95	624	026508025406	12	S989NL	419.60	453	026508302552	6
S0011	66.55	624	026508025413	12	S990	275.15	456	026508302569	6
S0012	145.30	624	026508025420	12	S990BG	412.75	456	026508302576	6
S0030NA	76.90	625	026508273821	6	S990BN	412.75	456	026508302583	6
S110	167.40	436	026508242353	6	S990NL	412.75	456	026508302590	6
S110BG	202.75	436	026508351321	6	S1001	544.40	429	026508282366	3
S110BN	202.75	436	026508242360	6	S1001EP	544.40	429	026508290507	3
S110BL	222.85	436	026508279434	6	S1002	580.70	429	026508290514	3
S110ORB	222.85	436	026508351352	6	S1002EP	580.70	429	026508290521	3
S112	572.40	430	026508132753	3	S1003	544.40	429	026508290538	3
S112EP	572.40	430	026508221761	3	S1003EP	544.40	429	026508290545	3
S112BG	775.05	430	026508323700	3	S1004	580.70	429	026508290552	3
S112BN	775.05	430	026508132760	3	S1004EP	580.70	429	026508290569	3
S112EPBG	775.05	430	026508323717	3	S1300	124.00	471	026508219621	6
S112EPBN	775.05	430	026508222065	3	S1311	610.65	429	026508152171	3
S112NL	775.05	430	026508144671	3	S1311EP	610.65	429	026508213988	3
S112EPNL	852.50	430	026508222072	3	S1311BG	833.45	429	026508285282	3
S112EPORB	852.50	430	026508222089	3	S1311BN	833.45	429	026508152188	3
S112EPWR	852.50	430	026508222096	3	S1311EPBG	833.45	429	026508285299	3
S112ORB	852.50	430	026508144664	3	S1311EPBN	833.45	429	026508214015	3
S112WR	852.50	430	026508132777	3	S1311EPNL	833.45	429	026508231180	3
S113	167.40	436	026508133965	6	S1311NL	833.45	429	026508231197	3
S113BG	202.75	436	026508285978	6	S1311BL	916.70	429	026508301326	3
S113BN	202.75	436	026508133972	6	S1311EPBL	916.70	429	026508301333	3
S113NL	202.75	436	026508144695	3	S1311EPORB	916.70	429	026508214022	3
S113ORB	222.85	436	026508144688	6	S1311ORB	916.70	429	026508152195	3
S113WR	222.85	436	026508133989	3	S2000ESUSA	261.90	51	026508343661	4
S116	181.80	436	026508349793	6	S3102	842.45	210	026508269916	3
S116BG	218.00	436	026508349809	6	S3104	1,800.30	465	026508269923	3
S116BN	218.00	436	026508349823	6	S3105	2,246.60	465	026508294277	1
S116BL	239.80	436	026508349816	6	S3105BN	3,032.85	208	026508294291	1
S116ORB	239.80	436	026508349830	6	S3105BL	3,336.20	208	026508294284	1
S122	61.50	436	026508223499	6	S3371	714.65	465	026508216408	6
S122BG	127.05	436	026508337851	6	S3600	181.70	465	026508216439	12
S122BN	127.05	436	026508223512	6	S3835	169.15	453	026508291221	6
S122NL	127.05	436	026508299517	6	S3835BN	245.25	453	026508291245	6
S122BL	139.90	436	026508299500	6	S3835BL	269.85	453	026508291238	6
S122ORB	139.90	436	026508223529	6	S3836	152.35	456	026508291252	6
S133	61.50	436	026508223536	6	S3836BN	220.90	456	026508291276	6
S133BG	127.05	436	026508351314	6	S3836BL	242.90	456	026508291269	6
S133BN	127.05	436	026508223543	6	S3870EPBN	982.55	439	026508228982	6
S133BL	139.90	436	026508351338	6	S3879EP	432.45	439	026508221884	6
S134	61.50	436	026508328620	6	S3879EPBN	867.70	439	026508221891	6
S134BG	127.05	436	026508328637	6	S3880EP	432.45	439	026508282380	6
S134BN	127.05	436	026508328651	6	S3880EPBG	867.70	439	026508318997	6
S134BL	139.90	436	026508328644	6	S3880EPBN	867.70	439	026508282373	6

Wholesale

Listed in numerical order

MODEL NUMBER	LIST PRICE	PAGE NO.	UNIVERSAL PRODUCT CODE	CASE QTY
S3880EPNL	867.70	439	026508316696	6
S3894	144.60	453	026508240144	6
S3896	138.40	453	026508220764	6
S3896BN	200.70	453	026508222126	6
S3896BL	207.55	453	026508370889	6
S3898	136.15	456	026508220450	6
S3898BL	197.40	456	026508370896	6
S3898BN	197.50	456	026508220467	6
S3945C	204.00	106	026508248911	6
S3945SRS	255.00	106	026508248935	6
S3945BL	265.20	106	026508289945	6
S3945NL	275.40	106	026508295236	6
S3945ORB	285.60	106	026508248928	6
S3945BG	295.80	106	026508283882	6
S3946C	204.00	107	026508248942	6
S3946SRS	255.00	107	026508248966	6
S3946BL	265.20	107	026508247167	6
S3946NL	275.40	107	026508316900	6
S3946ORB	285.60	107	026508248959	6
S3946BG	295.80	107	026508283899	6
S3946BLS	295.80	107	026508294581	6
S3947C	204.00	106	026508248973	6
S3947SRS	255.00	106	026508247327	6
S3947BL	265.20	106	026508289457	6
S3947BG	295.80	106	026508283905	6
S3947BLS	295.80	106	026508294598	6
S3948C	204.00	107	026508247150	6
S3948SRS	255.00	107	026508250280	6
S3948BL	265.20	107	026508289464	6
S3948ORB	285.60	107	026508250273	6
S3955C	204.00	106	026508300619	6
S3955SRS	255.00	106	026508300626	6
S3955BL	265.20	106	026508300602	6
S5000	261.50	453	026508310526	6
S5000BG	392.20	453	026508310533	6
S5000BN	392.20	453	026508310557	6
S5000BL	431.35	453	026508310540	6
S5001	244.65	456	026508310564	6
S5001BG	366.95	456	026508310571	6
S5001BN	366.95	456	026508310595	6
S5001BL	403.65	456	026508310588	6
S5235	880.35	65	026508316702	3
S5235EWC	1,030.40	65	026508373323	3
S5235SRS	1,100.40	75	026508316733	3
S5235BL	1,144.45	75	026508316719	3
S5235NL	1,188.45	75	026508316726	3
S5235EWSRS	1,287.90	65	026508373347	3
S5235EWBL	1,339.50	65	026508373316	3
S5235EWNL	1,391.00	65	026508373330	3
S5500	370.65	92	026508249475	6
S5510	424.35	102	026508249482	3
S5510SRS	530.45	102	026508249505	3
S5510BL	551.70	102	026508289471	3
S5510NL	572.90	102	026508294345	3
S5510ORB	594.10	102	026508249499	3
S5510BG	615.35	102	026508283912	3
S5520	424.35	102	026508249512	3
S5520SRS	530.45	102	026508249536	3
S5520BL	551.70	102	026508289488	3
S5520ORB	594.10	102	026508249529	3
S5520BG	615.35	102	026508283929	3
S5520BLS	615.35	102	026508294604	3
S5530	424.35	102	026508249543	3
S5530SRS	530.45	102	026508249550	3
S5530BL	551.70	102	026508289495	3
S5530BG	615.35	102	026508283936	3
S5530BLS	615.35	102	026508294611	3
S5535	396.00	102	026508316788	3
S5535SRS	495.00	102	026508316818	3
S5535BL	514.80	102	026508316795	3
S5535NL	534.60	102	026508316801	3
S5540	424.35	102	026508300633	3
S5540SRS	530.45	102	026508300657	3
S5540BL	551.70	102	026508300640	3
S5550	424.35	101	026508300695	3
S5550SRS	530.45	101	026508300718	3
S5550BL	551.70	101	026508300701	3
S5550BLS	615.35	101	026508316672	3
S5560	404.20	102	026508335758	3
S5560SRS	505.20	102	026508335772	3
S5560BL	525.45	102	026508335765	3
S5560NL	545.65	102	026508336755	3
S6235	609.45	93	026508316825	3
S6235SRS	761.85	93	026508316856	3
S6235BL	792.30	93	026508316832	3

MODEL NUMBER	LIST PRICE	PAGE NO.	UNIVERSAL PRODUCT CODE	CASE QTY
S6235NL	822.80	93	026508316849	3
S6310	254.10	431	026508220771	3
S6310EP	254.10	431	026508221921	3
S6310EPNL	332.65	431	026508234389	3
S6310NL	332.65	431	026508234549	3
S6310BN	349.35	431	026508220986	3
S6310EPBN	349.35	431	026508221938	3
S6310EPORB	366.80	431	026508221945	3
S6310EPWR	366.80	431	026508281000	3
S6310ORB	366.80	431	026508220993	3
S6310WR	366.80	431	026508221013	3
S6312	165.30	432	026508220788	12
S6312EP	165.30	432	026508222003	12
S6312BN	196.45	432	026508221037	12
S6312EPBN	196.45	432	026508222027	12
S6312EPNL	196.45	432	026508260845	6
S6312NL	196.45	432	026508260869	12
S6312EPORB	216.05	432	026508260852	12
S6312ORB	216.05	432	026508260876	12
S6320	387.05	430	026508220795	3
S6320EP	387.05	430	026508221853	3
S6320BG	608.30	430	026508286494	3
S6320BN	608.30	430	026508221068	3
S6320EPBG	608.30	430	026508285206	3
S6320EPBN	608.30	430	026508221860	3
S6320BL	669.00	430	026508351598	3
S6320EPBL	669.00	430	026508351604	3
S6320EPORB	669.00	430	026508221877	3
S6320ORB	669.00	430	026508221075	3
S6335	199.25	432	026508220849	6
S6335EP	199.25	432	026508221778	6
S6335EP15	199.25	432	026508264218	6
S6335BN	271.25	432	026508220863	6
S6335EPBN	271.25	432	026508222041	6
S6340	254.10	431	026508220801	3
S6340EP	254.10	431	026508221907	3
S6340EP15	254.10	429	026508241790	3
S6340BN	349.35	431	026508220634	3
S6340EP15BN	349.35	429	026508241806	3
S6340EPBN	349.35	431	026508221914	3
S6345	398.00	430	026508260944	3
S6345EP	398.00	430	026508260968	3
S6345BG	625.50	430	026508286036	3
S6345BN	625.50	430	026508260951	3
S6345EPBG	625.50	430	026508286043	3
S6345EPBN	625.50	430	026508260975	3
S6345BL	687.95	430	026508351611	3
S6345EPBL	687.95	430	026508351628	3
S6360	369.90	430	026508220481	3
S6360EP	369.90	430	026508220504	3
S6360BN	554.85	430	026508220498	3
S6360EPBN	554.85	430	026508220511	3
S6360EPORB	611.25	430	026508224946	3
S6360ORB	611.25	430	026508224953	3
S6365	254.10	431	026508230220	3
S6365EP	254.10	431	026508230244	3
S6365BG	349.35	431	026508285305	3
S6365BN	349.35	431	026508230237	3
S6365EPBG	349.35	431	026508285312	3
S6365EPBN	349.35	431	026508230251	3
S6365EPNL	349.35	431	026508301371	3
S6365NL	349.35	431	026508301388	3
S6365BL	366.80	431	026508289501	3
S6365EPBL	366.80	431	026508289518	3
S6365EPORB	366.80	431	026508230268	3
S6365ORB	366.80	431	026508230275	3
S6710	604.20	193	026508298206	3
S6710BN	906.30	193	026508298213	3
S6710BL	936.50	193	026508370902	3
S6712	845.70	193	026508298220	3
S6712BN	1,099.40	193	026508298237	3
S6712BL	1,141.65	193	026508370919	3
S6910	460.40	143	026508291085	3
S6910BN	598.55	207	026508291108	3
S6910BL	644.60	207	026508291092	3
S6910EW	825.90	143	026508355015	3
S6910EWBN	1,060.80	143	026508355039	3
S6910EWBL	1,156.25	143	026508355022	3
S6981	643.05	143	026508302408	3
S6981BN	835.95	169	026508302422	3
S6981NL	900.25	169	026508302439	3
S6981BG	932.40	169	026508302415	3
S6981EW	1,009.30	143	026508354971	3
S6981EWBN	1,261.60	143	026508354995	3
S6981EWNL	1,312.05	143	026508354988	3

Wholesale

Listed in numerical order

SUGGESTED LIST PRICES

MODEL NUMBER	LIST PRICE	PAGE NO.	UNIVERSAL PRODUCT CODE	CASE QTY	MODEL NUMBER	LIST PRICE	PAGE NO.	UNIVERSAL PRODUCT CODE	CASE QTY
S6981EWBG	1,362.55	143	026508355008	3	S62101BL	841.65	93	026508337172	3
S6982	771.65	169	026508302446	3	S62101NL	874.00	93	026508236437	3
S6982BN	1,003.15	169	026508302460	3	S62101ORB	906.35	93	026508236444	3
S6982NL	1,080.35	169	026508302477	3	S62101BG	938.75	93	026508283943	3
S6982BG	1,118.90	169	026508302453	3	S62308	657.60	92	026508236796	3
S7235	677.15	61	026508316863	3	S62308SRS	822.00	92	026508236819	3
S7235SRS	846.45	75	026508316894	3	S62308BL	854.90	92	026508236802	3
S7235BL	880.30	75	026508316870	3	S62308BG	953.50	92	026508283950	3
S7235NL	914.15	75	026508316887	3	S62308BLC	986.40	92	026508305775	3
S7235EVC	1,004.15	62	026508329191	3	S70005EV2C	1,213.05	59	026508357842	3
S7235EVSRS	1,104.60	62	026508329214	3	S70005EV2SRS	1,334.35	59	026508368343	3
S7235EVBL	1,154.80	62	026508329184	3	S70005EV2BL	1,395.05	59	026508357828	3
S7235EV2C	1,174.75	61	026508356777	3	S70005EV2BLS	1,455.70	59	026508357835	3
S7235EVNL	1,205.00	62	026508329207	3	S70909EV2CH	1,276.90	60	026508368350	3
S7235EV2SRS	1,292.20	61	026508356791	3	S70909EV2SRS	1,404.60	60	026508368312	3
S7235EV2BL	1,350.95	61	026508356760	3	S70909EV2BL	1,468.45	60	026508368329	3
S7235EV2NL	1,409.70	61	026508356784	3	S70909EV2BG	1,532.30	60	026508368336	3
S8000	507.05	205	026508261446	3	S70909EV2NL	1,532.30	60	026508368305	3
S8000BLC	785.95	205	026508305799	3	S72003	684.20	61	026508294765	3
S11705EP	352.40	442	026508221969	6	S72003SRS	855.25	76	026508294789	3
S11705EPBN	510.75	442	026508221952	6	S72003BL	889.45	76	026508294772	3
S12104	219.30	453	026508215531	6	S72003EVC	1,011.20	62	026508304648	3
S12104BG	347.35	453	026508285985	6	S72003EV2C	1,021.30	61	026508356746	3
S12104BN	347.35	453	026508215548	6	S72003EVSRS	1,112.30	62	026508304655	3
S12104NL	350.85	453	026508231166	6	S72003EV2SRS	1,123.40	61	026508356753	3
S12104BL	382.10	453	026508301302	6	S72003EVBL	1,162.85	62	026508304631	3
S12104ORB	382.10	453	026508215555	6	S72003EV2BL	1,174.45	61	026508356081	3
S12105	197.45	456	026508281246	6	S72103	850.10	76	026508300664	3
S12105BG	286.30	456	026508285992	6	S72103SRS	1,062.60	76	026508300688	3
S12105BN	286.30	456	026508281253	6	S72103BL	1,105.10	76	026508300671	3
S12105NL	286.30	456	026508281260	6	S72308	820.30	62	026508236826	3
S12105BL	314.95	456	026508301319	6	S72308SRS	1,025.40	71	026508236840	3
S12105ORB	314.95	456	026508281277	6	S72308BL	1,066.40	71	026508236833	3
S12107EP	711.80	439	026508218945	6	S72308EVC	1,151.10	62	026508303825	3
S12107EPBG	1,006.60	439	026508286005	6	S72308BG	1,189.45	71	026508283998	3
S12107EPBN	1,006.60	439	026508218952	6	S72308BLC	1,230.45	71	026508305782	3
S12107EPNL	1,006.60	439	026508231173	6	S72308EVSRS	1,266.20	62	026508303832	3
S12107EPORB	1,107.15	439	026508218969	6	S72308EVBL	1,323.75	62	026508303801	3
S12107EPBL	1,117.70	439	026508313381	6	S72308EVBG	1,381.30	62	026508303795	3
S16900	185.40	456	026508282946	6	S73004	704.95	60	026508288726	3
S16900BN	314.40	456	026508282953	6	S73004SRS	881.20	73	026508288757	3
S16900BL	345.95	456	026508301340	6	S73004BL	916.45	73	026508337196	3
S22105	2,322.25	147	026508251072	1	S73004NL	951.70	73	026508288733	3
S22105BN	3,367.30	147	026508251089	1	S73004ORB	986.95	73	026508288740	3
S22105BL	3,483.35	147	026508302293	1	S73004BG	1,022.20	73	026508299234	3
S22105NL	3,599.50	147	026508337448	1	S73004EVC	1,031.95	62	026508303856	3
S22105BG	3,715.60	147	026508373200	1	S73004EV2C	1,042.25	60	026508356821	3
S22105ORB	3,715.60	147	026508285015	1	S73004EVSRS	1,135.15	62	026508303887	3
S22110	2,322.25	147	026508255001	1	S73004EV2SRS	1,146.50	60	026508356852	3
S22110BN	3,367.30	147	026508255018	1	S73004EVBL	1,186.75	62	026508341520	3
S22110BL	3,483.35	147	026508302309	1	S73004EV2BL	1,198.60	60	026508356814	3
S22110NL	3,599.50	147	026508337455	1	S73004EVBG	1,238.35	62	026508303849	3
S22110BG	3,715.60	147	026508373217	1	S73004EVNL	1,238.35	62	026508303863	3
S22110ORB	3,715.60	147	026508285022	1	S73004EVORB	1,238.35	62	026508303870	3
S42107	780.10	145	026508215562	3	S73004EV2BG	1,250.70	60	026508356807	3
S42107BN	1,092.15	145	026508215579	3	S73004EV2NL	1,250.70	60	026508356838	3
S42107BL	1,131.15	145	026508301357	3	S73004EV2ORB	1,250.70	60	026508356845	3
S42107NL	1,170.15	145	026508231203	3	S73104	863.90	65	026508305386	3
S42107BG	1,209.20	145	026508286029	3	S73104EWC	1,013.90	65	026508373378	3
S42107ORB	1,209.20	145	026508215586	3	S73104SRS	1,079.85	73	026508305423	3
S43001	712.15	159	026508242391	3	S73104BL	1,123.05	73	026508337202	3
S43001BL	1,032.60	159	026508301364	3	S73104NL	1,166.25	73	026508305409	3
S44101	596.90	182	026508310441	3	S73104ORB	1,209.45	73	026508305416	3
S44101BN	775.95	182	026508310472	3	S73104BG	1,252.65	73	026508305393	3
S44101BL	835.65	182	026508310465	3	S73104EWSRS	1,267.40	65	026508373408	3
S44101BG	865.50	182	026508310458	3	S73104EWBL	1,318.10	65	026508373361	3
S44507	2,191.75	183	026508310489	1	S73104EWNL	1,368.80	65	026508373385	3
S44507BG	2,958.80	183	026508310496	1	S73104EWORB	1,419.50	65	026508373392	3
S44507BN	2,958.80	183	026508310519	1	S73104EWBG	1,470.20	65	026508373354	3
S44507BL	3,254.80	183	026508310502	1	S73204	1,015.95	72	026508337219	3
S52003	608.95	93	026508294734	3	S73204SRS	1,269.90	72	026508337264	3
S52003SRS	761.15	93	026508294758	3	S73204BL	1,320.70	72	026508337233	3
S52003BL	791.60	93	026508294741	3	S73204NL	1,371.50	72	026508337240	3
S53004	627.40	93	026508288689	3	S73204ORB	1,422.30	72	026508337257	3
S53004SRS	784.25	93	026508288719	3	S73204BG	1,473.10	72	026508337226	3
S53004BL	815.65	93	026508337165	3	S75005	825.25	60	026508288795	3
S53004NL	847.00	93	026508288696	3	S75005SRS	1,031.55	71	026508288818	3
S53004ORB	878.35	93	026508288702	3	S75005BL	1,072.80	71	026508288801	3
S53004BG	909.75	93	026508299241	3	S75005EVC	1,152.25	61	026508304716	3
S55005	734.45	92	026508288764	3	S75005EV2C	1,160.85	60	026508356883	3
S55005SRS	918.05	92	026508288788	3	S75005BLS	1,196.60	71	026508300589	3
S55005BL	954.75	92	026508288771	3	S75005EVSRS	1,267.45	61	026508304723	3
S55005BLS	1,064.95	92	026508300572	3	S75005EV2SRS	1,276.95	60	026508357583	3
S62101	647.40	93	026508236420	3	S75005EVBL	1,325.05	61	026508304693	3
S62101SRS	809.25	93	026508236451	3	S75005EV2BL	1,335.00	60	026508356869	3

Wholesale

Listed in numerical order

MODEL NUMBER	LIST PRICE	PAGE NO.	UNIVERSAL PRODUCT CODE	CASE QTY
S75005EVBL5	1,382.70	61	026508304709	3
S75005EV2BLS	1,393.00	60	026508356876	3
S93005	2,246.60	160	026508251096	1
S93005BL	3,032.90	160	026508302316	1
SMA1000CH	39.35	531	034584007728	24
SMA1000OWB	42.50	531	034584007735	24
SMA1001CH	37.70	531	034584007759	10
SR2100CH	15.10	508	034584013354	25
SR2100BN	17.30	508	034584013361	25
SR2100OWB	17.55	508	034584013378	25
SR2201CH	18.80	508	034584018830	12
SR2201BN	21.70	508	034584018823	12
SR2201OWB	22.00	508	034584018847	12
SR2201BL	30.50	508	034584029195	24
SR2201NL	30.50	508	034584029201	24
SV003	137.25	624	026508025444	12
SV006	127.95	624	026508025475	12
SV010	134.60	624	026508025512	12
T181	44.55	357	026508029565	12
T182	49.05	604	026508029589	12
T182EP	49.05	605	026508208786	12
T183	79.65	601	026508029602	12
T183EP	79.65	601	026508208809	12
T187	44.55	606	026508019832	12
T373	348.95	305	026508261316	3
T373BN	522.10	305	026508261323	3
T373BL	574.40	305	026508325612	3
T393	523.85	242	026508249642	3
T393BG	731.95	242	026508285909	3
T393BN	731.95	242	026508249659	3
T393BL	775.70	242	026508281925	3
T394	815.85	242	026508249666	3
T394BG	1,343.10	242	026508285893	3
T394BN	1,343.10	242	026508249673	3
T470	47.30	610	026508019825	12
T471	91.35	608	026508015742	12
T471EP	91.35	608	026508270813	12
T473	56.40	609	026508015728	12
T473EP	56.40	609	026508270967	12
T653	523.85	231	026508253830	3
T653BN	731.95	231	026508253847	3
T653ORB	805.10	231	026508256107	3
T654	815.85	231	026508256114	3
T654BN	1,343.10	231	026508254448	3
T654ORB	1,477.45	231	026508254578	3
T683	348.95	298	026508264621	3
T683BN	522.10	298	026508264638	3
T683BL	574.40	298	026508337066	3
T683ORB	574.40	298	026508264645	3
T693	502.70	285	026508230701	3
T693BG	702.45	285	026508286272	3
T693BN	702.45	285	026508230718	3
T693NL	702.45	285	026508301777	3
T693BL	728.95	285	026508373040	3
T693ORB	772.65	285	026508230725	3
T694	783.05	285	026508230732	3
T694BG	1,289.00	285	026508286487	3
T694BN	1,289.00	285	026508230749	3
T694NL	1,289.00	285	026508301784	3
T694BL	1,331.15	285	026508372227	3
T694ORB	1,417.85	285	026508230756	3
T908	349.00	343	026508295717	3
T908BN	522.10	343	026508295731	3
T908BL	574.35	343	026508295724	3
T924	547.95	311	026508162019	3
T924BN	694.15	311	026508161036	3
T924ORB	763.65	311	026508161043	3
T933	348.95	311	026508162118	3
T933BN	522.10	311	026508162132	3
T933ORB	574.40	311	026508162125	3
T935	523.85	253	026508027806	3
T935BL	805.15	253	026508301814	3
T936	815.85	253	026508235171	3
T943	348.95	320	026508153192	3
T943BN	522.10	320	026508153208	3
T943ORB	574.40	320	026508153215	3
T944	547.95	320	026508153161	3
T944BN	694.15	320	026508153178	3
T944ORB	763.65	320	026508153185	3
T961	341.55	334	026508272190	3
T961BN	496.55	334	026508289877	3
T961BL	546.20	334	026508289860	3
T990	332.60	351	026508125724	6
T994	205.15	351	026508017173	6
T2131	71.15	323	026508153222	3

MODEL NUMBER	LIST PRICE	PAGE NO.	UNIVERSAL PRODUCT CODE	CASE QTY
T2131BN	162.55	323	026508153239	3
T2131ORB	178.70	323	026508153246	3
T2132	93.35	323	026508153253	3
T2132BN	200.85	325	026508153260	3
T2132EPBN	200.85	323	026508209066	3
T2132EPORB	220.85	323	026508209073	3
T2132ORB	220.85	325	026508153277	3
T2133	135.80	322	026508153284	3
T2133BN	264.90	324	026508153291	3
T2133EPBN	264.90	322	026508207833	3
T2133EPORB	291.40	322	026508207840	3
T2133ORB	291.40	324	026508153307	3
T2137EP	166.65	324	026508272411	3
T2137EPBN	306.45	324	026508272428	3
T2137EPORB	339.05	324	026508272435	3
T2138	145.25	325	026508326923	3
T2138EP	145.25	325	026508326947	3
T2138BN	250.45	325	026508326930	3
T2138EPBN	250.45	325	026508326954	3
T2139	186.85	324	026508326961	3
T2139EP	186.85	324	026508326985	3
T2139BN	313.10	324	026508326978	3
T2139EPBN	313.10	324	026508326992	3
T2151	71.15	314	026508162149	3
T2151BN	162.55	314	026508162163	3
T2151ORB	178.70	314	026508162156	3
T2152	93.35	314	026508162170	3
T2152BN	200.85	316	026508162194	3
T2152EPBN	200.85	314	026508207871	3
T2152EPORB	220.85	314	026508207888	3
T2152ORB	220.85	316	026508162187	3
T2153	135.80	313	026508162200	3
T2153BN	264.90	315	026508162224	3
T2153EPBN	264.90	313	026508207918	3
T2153EPORB	291.40	313	026508207925	3
T2153ORB	291.40	315	026508162217	3
T2157EP	166.65	315	026508272442	3
T2157EPBN	306.45	315	026508272459	3
T2157EPORB	339.05	315	026508272466	3
T2181	71.15	301	026508264423	3
T2181BN	162.55	301	026508264430	3
T2181BL	178.70	301	026508336984	3
T2181ORB	178.70	301	026508264447	3
T2182EP	77.40	300	026508264478	3
T2182	93.35	300	026508264454	3
T2182BN	200.85	302	026508264461	3
T2182EPBN	200.85	300	026508264485	3
T2182BL	220.85	302	026508336991	3
T2182EPBL	220.85	300	026508337004	3
T2182EPORB	220.85	300	026508264492	3
T2182ORB	220.85	302	026508264508	3
T2183EP	116.60	300	026508264539	3
T2183	135.80	300	026508264515	3
T2183BN	264.90	302	026508264522	3
T2183EPBN	264.90	300	026508264546	3
T2183BL	291.40	302	026508337011	3
T2183EPBL	291.40	300	026508337028	3
T2183EPORB	291.40	300	026508264553	3
T2183ORB	291.40	302	026508264560	3
T2190	301.30	250	026508300107	4
T2190BG	547.05	250	026508300114	4
T2190BN	547.05	250	026508300138	4
T2190BL	601.90	250	026508300121	4
T2191	166.90	248	026508249680	3
T2191BG	303.00	248	026508286050	3
T2191BN	303.00	248	026508249178	3
T2191BL	333.40	248	026508275030	3
T2192NH	176.95	247	026508249314	3
T2192	222.40	247	026508249710	3
T2192EP	222.40	247	026508249185	3
T2192NHBG	321.35	247	026508286081	3
T2192NHBN	321.35	247	026508249321	3
T2192NHBL	353.50	247	026508275047	3
T2192BG	404.50	249	026508286067	3
T2192BN	404.50	249	026508249727	3
T2192EPBG	404.50	247	026508286074	3
T2192EPBN	404.50	247	026508249192	3
T2192BL	445.05	249	026508281888	3
T2192EPBL	445.05	247	026508281895	3
T2193NH	190.60	247	026508249338	3
T2193	283.05	247	026508249758	3
T2193EP	283.05	247	026508249208	3
T2193NHBG	372.60	247	026508286111	3
T2193NHBN	372.60	247	026508249345	3
T2193NHBL	409.95	247	026508275054	3

Wholesale

Listed in numerical order

MODEL NUMBER	LIST PRICE	PAGE NO.	UNIVERSAL PRODUCT CODE	CASE QTY	MODEL NUMBER	LIST PRICE	PAGE NO.	UNIVERSAL PRODUCT CODE	CASE QTY
T2193BG	514.25	249	026508286098	3	T2471BL	150.60	346	026508289587	3
T2193BN	514.25	249	026508249765	3	T2472NH	69.00	345	026508271247	3
T2193EPBG	514.25	247	026508286104	3	T2472EP	72.65	345	026508271230	3
T2193EPBN	514.25	247	026508249772	3	T2472NHBN	141.50	345	026508289631	3
T2193BL	565.60	249	026508281901	3	T2472EPBN	148.85	345	026508289617	3
T2193EPBL	565.60	247	026508281918	3	T2472NHBL	155.65	345	026508289624	3
T2221	166.90	226	026508364413	3	T2472EPBL	163.80	345	026508289600	3
T2221BG	303.00	226	026508364529	3	T2473NH	93.75	345	026508271261	3
T2221BN	303.00	226	026508364444	3	T2473EP	109.30	345	026508271254	3
T2221BL	333.40	226	026508364406	3	T2473NHBN	186.35	345	026508289679	3
T2222EP	222.40	226	026508364390	3	T2473NHBL	205.05	345	026508289662	3
T2222EPBG	404.50	226	026508364482	3	T2473EPBN	210.20	345	026508289655	3
T2222EPBN	404.50	226	026508364499	3	T2473EPBL	231.15	345	026508289648	3
T2222EPBL	445.05	226	026508364567	3	T2662EP	75.75	330	026508273098	3
T2223EP	283.05	226	026508364468	3	T2663EP	114.10	330	026508273111	3
T2223EPBG	514.25	226	026508364574	3	T2690	289.20	293	026508300220	4
T2223EPBN	514.25	226	026508364345	3	T2690BG	525.10	293	026508300237	4
T2223EPBL	565.60	226	026508364451	3	T2690BN	525.10	293	026508300244	4
T2232EP	145.25	323	026508271414	4	T2690NL	525.10	293	026508300251	4
T2232EPBN	250.45	323	026508271544	4	T2690BL	534.95	293	026508373019	4
T2232EPORB	270.00	323	026508271551	4	T2690ORB	577.60	293	026508300268	4
T2233EP	186.85	322	026508271407	4	T2691	160.15	291	026508230282	3
T2233EPBN	313.10	322	026508271568	4	T2691BG	290.85	291	026508286128	3
T2233EPORB	339.05	322	026508271575	4	T2691BN	290.85	291	026508230299	3
T2252EP	145.25	314	026508271391	4	T2691NL	290.85	291	026508301487	3
T2252EPBN	250.45	314	026508271582	4	T2691BL	296.30	291	026508372999	3
T2252EPORB	270.00	314	026508271599	4	T2691ORB	320.05	291	026508230305	3
T2253EP	186.85	313	026508271384	4	T2692NH	169.80	292	026508230367	3
T2253EPBN	313.10	313	026508271605	4	T2692	213.45	291	026508230312	3
T2253EPORB	339.05	313	026508271612	4	T2692EP	213.45	291	026508230336	3
T2261	160.15	280	026508336007	3	T2692NHBN	308.40	292	026508230374	3
T2261BG	290.85	280	026508336014	3	T2692BG	388.25	292	026508286135	3
T2261BN	290.85	280	026508336038	3	T2692BN	388.25	292	026508230329	3
T2261BL	320.05	280	026508336021	3	T2692EPBG	388.25	291	026508286142	3
T2262EP	213.45	280	026508336045	4	T2692EPBN	388.25	291	026508230343	3
T2262EPBG	388.25	280	026508336052	4	T2692EPNL	388.25	291	026508301494	3
T2262EPBN	388.25	280	026508336076	4	T2692NL	388.25	292	026508301517	3
T2262EPBL	427.10	280	026508336069	4	T2692BL	394.85	292	026508372968	3
T2263EP	271.60	280	026508336083	4	T2692EPBL	394.85	291	026508373033	3
T2263EPBG	493.50	280	026508336090	4	T2692EPORB	427.00	291	026508230350	3
T2263EPBN	493.50	280	026508336113	4	T2692ORB	427.00	292	026508230398	3
T2263EPBL	542.80	280	026508336106	4	T2693NH	182.90	292	026508230459	3
T2282EP	145.25	300	026508271438	4	T2693	271.60	291	026508230404	3
T2282EPBN	250.45	300	026508271629	4	T2693EP	271.60	291	026508230428	3
T2282EPBL	270.00	300	026508337035	4	T2693NHBN	357.60	292	026508230466	3
T2282EPORB	270.00	300	026508271636	4	T2693BG	493.50	292	026508286166	3
T2283EP	186.85	300	026508271421	4	T2693BN	493.50	292	026508230411	3
T2283EPBN	313.10	300	026508271643	4	T2693EPBG	493.50	291	026508286173	3
T2283EPBL	339.05	300	026508337042	4	T2693EPBN	493.50	291	026508230435	3
T2283EPORB	339.05	300	026508271650	4	T2693EPNL	493.50	291	026508301524	3
T2310	290.35	270	026508300145	4	T2693NL	493.50	292	026508301548	3
T2310BN	527.20	270	026508300152	4	T2693BL	502.45	292	026508373071	3
T2310NL	527.20	270	026508300169	4	T2693EPBL	502.45	291	026508373026	3
T2310BL	537.15	270	026508371381	4	T2693EPORB	543.10	291	026508230442	3
T2310ORB	579.95	270	026508300176	4	T2693ORB	543.10	292	026508230480	3
T2311	160.85	268	026508275429	3	T2741	71.15	307	026508261217	3
T2311BN	292.00	268	026508275436	3	T2741BN	162.55	307	026508261224	3
T2311NL	292.00	268	026508301418	3	T2741BL	178.70	307	026508325544	3
T2311BL	297.60	268	026508371398	3	T2742EP	77.40	306	026508261255	3
T2311ORB	321.20	268	026508275443	3	T2742	93.35	306	026508261231	3
T2312	214.30	268	026508275450	4	T2742BN	200.85	308	026508261248	3
T2312EP	214.30	268	026508275474	4	T2742EPBN	200.85	306	026508261262	3
T2312BN	389.80	269	026508275467	4	T2742BL	220.85	308	026508325551	3
T2312EPBN	389.80	268	026508275481	4	T2742EPBL	220.85	306	026508325568	3
T2312EPNL	389.80	268	026508301425	4	T2743EP	116.60	306	026508261293	3
T2312NL	389.80	269	026508301449	4	T2743	135.80	306	026508261279	3
T2312BL	396.45	269	026508371404	4	T2743BN	264.90	308	026508261286	3
T2312EPBL	396.45	268	026508371411	4	T2743EPBN	264.90	306	026508261309	3
T2312EPORB	428.60	268	026508275498	4	T2743BL	291.40	308	026508325575	3
T2312ORB	428.60	269	026508275535	4	T2743EPBL	291.40	306	026508325582	3
T2313	272.50	268	026508275542	4	T2810	301.30	259	026508300305	4
T2313EP	272.50	268	026508275566	4	T2810BL	601.90	259	026508300312	4
T2313BN	495.40	269	026508275559	4	T2811	166.90	258	026508235102	3
T2313EPBN	495.40	268	026508275573	4	T2811BL	333.35	258	026508301555	3
T2313EPNL	495.40	268	026508301456	4	T2812NH	176.95	257	026508255671	3
T2313NL	495.40	269	026508301470	4	T2812	222.40	257	026508235119	3
T2313BL	504.15	269	026508371428	4	T2812EP	222.40	257	026508235126	3
T2313EPBL	504.15	268	026508371435	4	T2812NHBL	353.50	257	026508301586	3
T2313EPORB	545.25	268	026508275580	4	T2812BL	445.00	258	026508301562	3
T2313ORB	545.25	269	026508275627	4	T2812EPBL	445.00	257	026508301579	3
T2470	99.15	348	026508300183	4	T2813NH	190.60	257	026508255688	3
T2470BN	143.75	348	026508300206	4	T2813	283.05	257	026508235133	3
T2470BL	154.85	348	026508300190	4	T2813EP	283.05	257	026508235140	3
T2471	66.80	346	026508271223	3	T2813NHBL	409.90	257	026508301616	3
T2471BN	136.85	346	026508289594	3	T2813BL	565.60	258	026508301593	3

Wholesale

Listed in numerical order

MODEL NUMBER	LIST PRICE	PAGE NO.	UNIVERSAL PRODUCT CODE	CASE QTY	MODEL NUMBER	LIST PRICE	PAGE NO.	UNIVERSAL PRODUCT CODE	CASE QTY
T2813EPBL	565.60	257	026508301609	3	T4412ORB	251.15	263	026508290842	6
T2842EP	145.25	306	026508271452	4	T4500	301.30	238	026508300367	4
T2842EPBN	250.45	306	026508271667	4	T4500BN	547.05	238	026508300374	4
T2842EPBL	270.00	306	026508325599	4	T4500ORB	601.90	238	026508300398	4
T2843EP	186.85	306	026508271445	4	T4501	166.90	237	026508253441	3
T2843EPBN	313.10	306	026508271674	4	T4501BN	303.00	237	026508253458	3
T2843EPBL	339.05	306	026508325605	4	T4501ORB	333.40	237	026508255766	3
T2900	103.50	339	026508300336	4	T4502	222.40	237	026508253465	3
T2900BN	150.10	339	026508300350	4	T4502EP	222.40	237	026508253489	3
T2900BL	165.15	339	026508300343	4	T4502BN	404.50	237	026508253472	3
T2901	69.75	337	026508272121	3	T4502EPBN	404.50	237	026508253496	3
T2901BN	143.20	337	026508289693	3	T4502EPORB	444.90	237	026508255780	3
T2901BL	157.55	337	026508289686	3	T4502ORB	444.90	237	026508255810	3
T2902NH	72.05	337	026508272145	3	T4503	283.05	237	026508253519	3
T2902EP	75.75	337	026508272138	3	T4503EP	283.05	237	026508253533	3
T2902NHBN	148.10	337	026508289730	3	T4503BN	514.25	237	026508253526	3
T2902EPBN	155.75	337	026508289716	3	T4503EPBN	514.25	237	026508253540	3
T2902NHBL	162.90	337	026508289723	3	T4503EPORB	565.90	237	026508255834	3
T2902EPBL	171.35	337	026508289709	3	T4503ORB	565.90	237	026508255872	3
T2903NH	97.70	336	026508272169	3	T4520	373.60	229	026508253403	3
T2903EP	114.10	336	026508272152	3	T4520BN	560.45	229	026508253700	3
T2903NHBN	194.90	336	026508289778	3	T4520ORB	597.80	229	026508255919	3
T2903NHBL	214.40	336	026508289761	3	T4524	381.00	229	026508253717	3
T2903EPBN	215.00	336	026508289754	3	T4524BN	571.50	229	026508253762	3
T2903EPBL	236.55	336	026508289747	3	T4524ORB	609.60	229	026508255933	3
T3002EP	129.75	337	026508272176	4	T4611	146.90	290	026508230589	12
T3002EPBN	230.40	337	026508289822	4	T4611BG	197.35	290	026508285862	12
T3002EPBL	253.45	337	026508306024	4	T4611BN	197.35	290	026508230596	12
T3003EP	168.00	336	026508272183	4	T4611NL	197.35	290	026508301715	12
T3003EPBN	316.65	336	026508289839	4	T4611BL	205.65	290	026508371237	12
T3003EPBL	348.35	336	026508306031	4	T4611ORB	217.05	290	026508230602	12
T3111	184.40	550	026508108017	3	T4612	146.90	551	026508281338	12
T3111BN	430.30	550	026508115336	3	T4612BG	197.35	551	026508286241	12
T3111ORB	473.40	550	026508132395	3	T4612BN	197.35	551	026508281345	12
T3290	229.60	246	026508294864	3	T4612NL	197.35	551	026508301722	12
T3290BN	308.40	246	026508294888	3	T4612BL	205.65	551	026508373064	12
T3290BL	339.25	246	026508294871	3	T4612ORB	217.05	551	026508281352	12
T3291	197.55	245	026508249819	3	T4621	291.25	276	026508336120	3
T3291BG	420.80	245	026508286197	3	T4621BG	439.95	276	026508336137	3
T3291BN	420.80	245	026508249826	3	T4621BN	439.95	276	026508336151	3
T3691	189.60	289	026508230497	3	T4621BL	473.40	276	026508336144	3
T3691BG	403.80	289	026508285329	3	T4622	148.30	276	026508336168	6
T3691BN	403.80	289	026508230503	3	T4622BG	223.50	276	026508336175	6
T3691NL	403.80	289	026508301654	3	T4622BN	223.50	276	026508336199	6
T3691BL	417.05	289	026508372982	3	T4622BL	241.00	276	026508336182	6
T3691ORB	444.40	289	026508230510	3	T4691	292.10	286	026508290859	3
T4111	239.10	550	026508115176	3	T4691BG	439.95	286	026508290866	3
T4111BN	321.15	550	026508115558	3	T4691BN	439.95	286	026508290873	3
T4111ORB	353.20	550	026508132425	3	T4691NL	439.95	286	026508290880	3
T4191	153.05	246	026508249253	12	T4691BL	452.70	286	026508371244	3
T4191BG	205.65	246	026508285886	12	T4691ORB	474.55	286	026508290897	3
T4191BN	205.65	246	026508249260	12	T4692	148.30	286	026508290903	6
T4191BL	226.20	246	026508275061	12	T4692BG	223.50	286	026508290910	6
T4192	151.75	551	026508260326	12	T4692BN	223.50	286	026508290927	6
T4192BG	205.65	551	026508285879	12	T4692NL	223.50	286	026508290934	6
T4192BN	205.65	551	026508281666	12	T4692BL	229.85	286	026508371251	6
T4192BL	226.20	551	026508281659	12	T4692ORB	241.00	286	026508290941	6
T4291	303.55	243	026508290668	3	T4943	263.35	311	026508162088	3
T4291BG	458.40	243	026508290705	3	T4943BN	343.80	311	026508162101	3
T4291BN	458.40	243	026508290729	3	T4943ORB	378.05	311	026508162095	3
T4291BL	493.25	243	026508290712	3	T5220	471.55	326	026508171769	3
T4292	154.50	243	026508290736	6	T5220BN	569.35	326	026508171776	3
T4292BG	232.90	243	026508290743	6	T6142	209.30	334	026508272114	3
T4292BN	232.90	243	026508290767	6	T6142BN	313.95	334	026508289853	3
T4292BL	251.15	243	026508290750	6	T6142BL	345.30	334	026508289846	3
T4311	159.70	264	026508250402	6	T6173	213.85	304	026508261330	3
T4311BN	214.70	264	026508250419	6	T6173BN	299.40	304	026508261347	3
T4311ORB	236.05	264	026508250426	6	T6173BL	320.80	304	026508325629	3
T4401	303.55	220	026508364383	3	T6193	370.20	240	026508249857	3
T4401BG	458.40	220	026508364376	3	T6193BN	573.75	240	026508249291	3
T4401BN	458.40	220	026508364369	3	T6193BL	592.30	240	026508275078	3
T4401BL	493.25	220	026508364536	3	T6193BG	610.80	240	026508286258	3
T4402	154.50	220	026508364437	6	T6222	355.25	274	026508336205	3
T4402BG	232.90	220	026508364475	6	T6222BN	532.85	274	026508336236	3
T4402BN	232.90	220	026508364505	6	T6222BL	568.35	274	026508336229	3
T4402BL	251.15	220	026508364543	6	T6222BG	586.15	274	026508336212	3
T4411	304.30	263	026508290774	3	T6223	502.70	276	026508336243	3
T4411BN	458.40	263	026508290781	3	T6223BG	702.45	276	026508336250	3
T4411NL	458.40	263	026508290798	3	T6223BN	702.45	276	026508336274	3
T4411BL	471.65	263	026508371558	3	T6223BL	772.70	276	026508336267	3
T4411ORB	494.50	263	026508290804	3	T6405	382.05	261	026508275757	3
T4412	154.50	263	026508290811	6	T6405BN	534.90	261	026508275764	3
T4412BN	232.90	263	026508290828	6	T6405BL	554.00	261	026508371367	3
T4412NL	232.90	263	026508290835	6	T6405NL	554.00	261	026508301739	3
T4412BL	239.45	263	026508371541	6	T6405ORB	573.10	261	026508275771	3

Wholesale

Listed in numerical order

SUGGESTED LIST PRICES

MODEL NUMBER	LIST PRICE	PAGE NO.	UNIVERSAL PRODUCT CODE	CASE QTY	MODEL NUMBER	LIST PRICE	PAGE NO.	UNIVERSAL PRODUCT CODE	CASE QTY
T6420	213.85	319	026508153130	3	T62152EP	77.40	316	026508208397	12
T6420BN	299.40	319	026508153147	3	T62153	116.60	315	026508162040	12
T6420ORB	331.50	319	026508153154	3	T62153EP	116.60	315	026508208410	12
T6503	523.85	219	026508364550	3	T62182	77.40	603	026508264577	12
T6503BG	731.95	219	026508364512	3	T62183	116.60	600	026508264584	12
T6503BN	731.95	219	026508364420	3	T62742	77.40	603	026508261354	12
T6503BL	775.70	219	026508364352	3	T62743	116.60	600	026508261361	6
T6601	304.30	232	026508290958	3	T90331	45.65	460	026508184455	12
T6601BN	458.40	232	026508290965	3	T90331BG	143.95	460	026508286289	12
T6601ORB	494.50	232	026508290682	3	T90331BN	143.95	460	026508184509	12
T6602	154.50	232	026508290699	6	T90331NL	143.95	460	026508184516	12
T6602BN	232.90	232	026508290972	6	T90331ORB	158.35	460	026508184523	12
T6602ORB	251.15	232	026508290996	6	T90331WR	158.35	460	026508184578	12
T6620	213.85	310	026508162071	3	TF3347	322.50	458	026508357095	6
T6620BN	299.40	310	026508161012	3	TF3347BG	412.80	458	026508357101	6
T6620ORB	331.50	310	026508161029	3	TF3347BN	412.80	458	026508357125	6
T6708	176.15	342	026508295687	3	TF3347BL	454.10	458	026508357118	6
T6708BN	237.80	342	026508295700	3	TF3858	225.00	459	026508357132	6
T6708BL	255.40	342	026508295694	3	TF3858BN	303.75	459	026508357156	6
T6805	213.85	297	026508264591	3	TF3858BL	334.15	459	026508357149	6
T6805BN	299.40	297	026508264607	3	TF3858ORB	334.15	459	026508357163	6
T6805BL	320.80	297	026508337059	3	TF3901	234.45	459	026508357170	6
T6805ORB	331.50	297	026508264614	3	TF3901BN	316.50	459	026508357194	6
T6905	355.25	283	026508230640	3	TF3901BL	348.20	459	026508357187	6
T6905BN	532.85	283	026508230657	3	TF4326	360.15	458	026508372388	6
T6905BL	550.60	283	026508372203	3	TF4326BG	460.95	458	026508372395	6
T6905NL	550.60	283	026508301746	3	TF4326BN	460.95	458	026508372418	6
T6905ORB	568.35	283	026508230664	3	TF4326BL	507.10	458	026508372401	6
T6905BG	586.15	283	026508284650	3	TF191956	335.00	458	026508356937	6
T6906	404.95	284	026508230671	3	TF191956BG	428.80	458	026508356944	6
T6906BL	587.20	284	026508372210	3	TF191956BN	428.80	458	026508356951	6
T6906BN	587.20	284	026508230688	3	TF191956NL	428.80	458	026508356968	6
T6906NL	607.45	284	026508301753	3	TF191956BL	450.15	458	026508371336	6
T6906ORB	627.70	284	026508230695	3	TF191956ORB	471.70	458	026508356975	6
T6906BG	647.90	284	026508286265	3	TF193371	300.00	458	026508356982	6
T6920	370.20	252	026508235157	3	TF193371BN	384.00	458	026508356999	6
T6920BL	610.80	252	026508301760	3	TF193371NL	384.00	458	026508357002	6
T8342NH	352.35	653	026508237175	1	TF193371BL	403.15	458	026508372173	6
T8342	361.00	653	026508228562	1	TF193371ORB	422.40	458	026508357019	6
T8342EP15	361.00	653	026508228579	1	TF195386	225.00	459	026508357026	6
T8342NHCBN	483.15	653	026508237182	1	TF195386BN	303.75	459	026508357040	6
T8342CBN	530.65	653	026508237151	1	TF195386BL	334.15	459	026508357033	6
T8342EP15CBN	530.65	653	026508237168	1	TF195827	360.15	458	026508357057	6
T8343	381.40	651	026508228586	1	TF195827BG	460.95	458	026508357064	6
T8343EP15	381.40	651	026508228593	1	TF195827BN	460.95	458	026508357088	6
T8343CBN	560.80	651	026508237199	1	TF195827BL	507.10	458	026508357071	6
T8343EP15CBN	560.80	651	026508237625	1	TFS990	365.00	458	026508357293	6
T8346	333.15	655	026508228609	4	TFS990BG	492.75	458	026508357309	6
T8346EP15	333.15	655	026508228616	4	TFS990BN	492.75	458	026508357316	6
T8346CBN	472.40	655	026508235638	4	TFS990NL	492.75	458	026508357323	6
T8346EP15CBN	472.40	655	026508235645	4	TFS3836	348.80	458	026508357200	6
T8360	48.15	660	026508222775	3	TFS3836BN	488.30	458	026508357224	6
T8360CBN	87.95	660	026508235652	3	TFS3836BL	537.15	458	026508357217	6
T8370	37.65	658	026508211885	3	TFS3898	348.80	458	026508357231	6
T8370CBN	68.75	658	026508235669	3	TFS3898BN	470.90	458	026508357248	6
T8375NH	46.10	657	026508235690	3	TFS3898BL	488.30	458	026508370933	6
T8375	65.05	657	026508211892	3	TFS5001	376.05	458	026508358375	6
T8375EP15	65.05	657	026508222782	3	TFS5001BG	507.65	458	026508357255	6
T8375NHCBN	77.05	657	026508235706	3	TFS5001BN	507.65	458	026508357279	6
T8389	99.60	656	026508212134	3	TFS5001BL	558.45	458	026508357262	6
T8389EP15	99.60	656	026508222799	3	TL181	44.55	353	026508047620	12
T8389EP15CBN	155.60	656	026508235720	3	TL182NH	46.50	352	026508208496	12
T9023	471.85	262	026508275788	3	TL182	49.05	352	026508047552	12
T9023BN	663.10	262	026508275795	3	TL182EP	49.05	352	026508208472	12
T9023NL	663.10	262	026508301791	3	TL183NH	69.95	352	026508208533	12
T9023BL	684.20	262	026508371374	3	TL183	79.65	352	026508047590	12
T9023ORB	720.05	262	026508275801	3	TL183EP	79.65	352	026508208519	12
T9024	641.30	262	026508275818	3	TL470	47.30	610	026508047842	12
T9024BN	903.05	262	026508275825	3	TL471	91.35	608	026508047828	12
T9024NL	903.05	262	026508301807	3	TL471EP	91.35	608	026508271056	12
T9024BL	929.85	262	026508372234	3	TL473	56.40	609	026508047774	12
T9024ORB	968.50	262	026508275832	3	TL473EP	56.40	609	026508271087	12
T9342EP15	493.55	652	026508257340	1	TL2368EP	103.40	356	026508242414	6
T9342GBM15	542.85	652	026508257388	1	TL2369EP	125.75	355	026508242421	6
T9346GBM15	478.25	654	026508255568	1	TR1000BN	38.85	507	034584017710	3
T9360	133.20	660	026508255582	3	TR1000CH	38.85	507	034584017727	3
T9370	104.10	658	026508255599	3	TR1000WB	38.85	507	034584017734	3
T9375EP15	130.25	657	026508255612	3	TR1000BL	42.75	507	034584033772	3
T9389EP15	165.70	656	026508255636	3	TR1032BN	54.65	507	034584029164	3
T62132	77.40	325	026508152508	12	TS913	741.90	195	026508298282	3
T62132EP	77.40	325	026508208359	12	TS913BN	1,038.65	195	026508298299	3
T62133	116.60	324	026508152515	12	TS913BL	1,075.75	195	026508371022	3
T62133EP	116.60	324	026508208373	12	TS914	1,155.50	195	026508298305	3
T62151	57.60	606	026508162026	12	TS914BN	1,938.75	195	026508298312	3
T62152	77.40	316	026508162033	12	TS914BL	1,964.35	195	026508371039	3

Wholesale

Listed in numerical order

MODEL NUMBER	LIST PRICE	PAGE NO.	UNIVERSAL PRODUCT CODE	CASE QTY
TS926	1,035.00	172	026508303245	3
TS926BG	1,500.70	172	026508303252	3
TS926BN	1,500.70	172	026508303269	3
TS926NL	1,500.70	172	026508303276	3
TS927	1,061.65	172	026508303283	3
TS927BG	1,527.40	172	026508303290	3
TS927BN	1,527.40	172	026508303306	3
TS927NL	1,527.40	172	026508303313	3
TS928	1,364.85	172	026508303320	3
TS928BG	1,978.95	172	026508303337	3
TS928BN	1,978.95	172	026508303344	3
TS928NL	1,978.95	172	026508303351	3
TS929	1,391.45	172	026508303368	3
TS929BG	2,005.65	172	026508303375	3
TS929BN	2,005.65	172	026508303382	3
TS929NL	2,005.65	172	026508303399	3
TS983	505.40	209	026508291146	3
TS983BN	707.50	209	026508291160	3
TS983BL	778.25	209	026508291153	3
TS984	787.25	209	026508291177	3
TS984BN	1,102.20	209	026508291191	3
TS984BL	1,212.40	209	026508291184	3
TS1320	195.15	447	026508219638	6
TS1320BN	275.15	447	026508219645	6
TS1320NL	275.15	447	026508250754	6
TS1320ORB	310.60	447	026508219652	6
TS1322	195.15	447	026508219669	6
TS1322BG	275.15	447	026508285374	6
TS1322BN	275.15	447	026508219676	6
TS1322NL	275.15	447	026508250761	6
TS1322BL	310.60	447	026508301821	6
TS1322ORB	310.60	447	026508219683	6
TS1420	302.05	447	026508252543	6
TS1420BN	409.30	447	026508258743	6
TS1420NL	409.30	447	026508258750	6
TS1420ORB	450.35	447	026508258767	6
TS1422	302.05	447	026508258798	6
TS1422BG	409.30	447	026508286296	6
TS1422BN	409.30	447	026508258804	6
TS1422NL	409.30	447	026508258811	6
TS1422BL	450.35	447	026508301838	6
TS1422ORB	450.35	447	026508258828	6
TS2200	523.05	165	026508300404	4
TS2200BN	758.40	216	026508300459	4
TS2200BL	834.30	216	026508300442	4
TS2201	250.15	214	026508291283	3
TS2201BN	362.80	214	026508291306	3
TS2201BL	399.05	214	026508291290	3
TS2202	333.55	214	026508291313	4
TS2202EP	333.55	214	026508291344	4
TS2202BN	483.60	215	026508291337	4
TS2202EPBN	483.60	214	026508291368	4
TS2202BL	532.05	215	026508291320	4
TS2202EPBL	532.05	214	026508291351	4
TS2203	424.10	214	026508291405	4
TS2203EP	424.10	214	026508291436	4
TS2203BN	615.00	215	026508291429	4
TS2203EPBN	615.00	214	026508291450	4
TS2203BL	676.35	215	026508291412	4
TS2203EPBL	676.35	214	026508291443	4
TS2710	486.15	202	026508300466	4
TS2710BN	900.05	202	026508300473	4
TS2710BL	923.65	202	0265083070940	4
TS2711	236.30	200	026508215111	3
TS2711BN	437.60	200	026508216989	3
TS2711BL	449.00	200	0265083070957	3
TS2712	315.25	200	026508215128	3
TS2712EP	315.25	200	026508222218	3
TS2712BN	583.85	201	026508216996	3
TS2712EPBN	583.85	200	026508223413	3
TS2712BL	598.95	201	0265083070964	3
TS2712EPBL	598.95	200	0265083070971	3
TS2713	400.70	200	026508215135	3
TS2713EP	400.70	200	026508222249	3
TS2713BN	742.35	201	026508217009	3
TS2713EPBN	742.35	200	026508223437	3
TS2713BL	761.30	201	0265083073187	3
TS2713EPBL	761.30	200	0265083073194	3
TS2911	286.85	177	026508302066	3
TS2911BG	430.20	177	026508302613	3
TS2911BN	430.20	177	026508302620	3
TS2911NL	430.20	177	026508302637	3
TS2912	434.15	177	026508302644	4
TS2912EP	434.15	177	026508302675	4
TS2912BG	651.15	178	026508302651	4

MODEL NUMBER	LIST PRICE	PAGE NO.	UNIVERSAL PRODUCT CODE	CASE QTY
TS2912BN	651.15	178	026508302668	4
TS2912EPBG	651.15	177	026508302682	4
TS2912EPBN	651.15	177	026508302699	4
TS2912EPNL	651.15	177	026508302705	4
TS2912NL	651.15	178	026508302750	4
TS2913	552.10	177	026508302767	4
TS2913EP	552.10	177	026508302798	4
TS2913BG	828.05	178	026508302774	4
TS2913BN	828.05	178	026508302781	4
TS2913EPBG	828.05	177	026508302804	4
TS2913EPBN	828.05	177	026508302811	4
TS2913EPNL	828.05	177	026508302828	4
TS2913NL	828.05	178	026508302873	4
TS3100	398.25	196	026508223581	3
TS3100BN	602.40	196	026508223598	3
TS3100BL	617.25	196	0265083070988	3
TS3101	421.45	210	026508291498	3
TS3101BN	611.05	210	026508291511	3
TS3101BL	672.15	210	026508291504	3
TS3102	194.50	210	026508291528	6
TS3102BN	282.10	210	026508291542	6
TS3102BL	310.25	210	026508291535	6
TS3210	402.10	155	026508215715	3
TS3210BG	568.75	156	026508286371	3
TS3210BN	568.75	156	026508215845	3
TS3210NL	568.75	156	026508231319	3
TS3210BL	613.80	156	026508301999	3
TS3210ORB	613.80	156	026508215852	3
TS3300	183.85	161	026508223635	6
TS3300BN	245.15	196	026508223642	6
TS3300BL	248.15	196	0265083070995	6
TS3302BL	553.95	366	026508299203	3
TS3302TB	553.95	366	026508269930	3
TS3304BL	842.45	366	026508299210	3
TS3304TB	842.45	366	026508269947	3
TS3661NH	700.40	413	026508266991	3
TS3661NHBG	1,106.45	413	026508324585	3
TS3661NHBN	1,106.45	413	026508279458	3
TS3661NHBL	1,167.50	413	026508279441	3
TS3661NHORB	1,167.50	413	026508279465	3
TS4201	402.00	173	026508303009	3
TS4201BG	603.00	173	026508303016	3
TS4201BN	603.00	173	026508303023	3
TS4201NL	603.00	173	026508303030	3
TS4202	185.50	173	026508303047	6
TS4202BG	278.40	173	026508303054	6
TS4202BN	278.40	173	026508303061	6
TS4202NL	278.40	173	026508303078	6
TS4211	362.35	145	026508215302	3
TS4211BN	496.15	550	026508217610	3
TS4211ORB	522.65	550	026508217627	3
TS6721	540.90	193	026508298244	3
TS6721BN	811.35	193	026508298251	3
TS6721BL	838.40	193	0265083071008	3
TS6731	627.35	194	026508298268	3
TS6731BN	846.90	194	026508298275	3
TS6731BL	878.30	194	0265083071015	3
TS6925	409.60	207	026508291115	3
TS6925BN	532.50	207	026508291139	3
TS6925BL	573.45	207	026508291122	3
TS6984	613.65	170	026508303160	3
TS6984BN	797.75	170	026508303184	3
TS6984NL	859.15	170	026508303191	3
TS6984BG	889.80	170	026508303177	3
TS6985	640.40	170	026508303207	3
TS6985BN	832.50	170	026508303221	3
TS6985NL	896.55	170	026508303238	3
TS6985BG	928.55	170	026508303214	3
TS8002BLC	925.80	205	026508305805	3
TS21102	1,739.20	148	026508215593	3
TS21102BG	3,027.40	148	026508286302	3
TS21102BN	3,027.40	148	026508215609	3
TS21102NL	3,027.40	148	026508211203	3
TS21102BL	3,266.30	148	026508301845	3
TS21102ORB	3,266.30	148	026508215616	3
TS21103	1,739.20	148	026508215623	3
TS21104BG	3,027.40	148	026508286319	3
TS21104BN	3,027.40	148	026508215630	3
TS21104NL	3,027.40	148	026508231227	3
TS21104BL	3,266.30	148	026508301852	3
TS21104ORB	3,266.30	148	026508215647	3
TS22000	801.35	167	026508300411	4
TS22000BL	1,310.60	167	026508305720	4
TS22001	373.70	165	026508242438	3
TS22001BL	611.35	165	026508301869	3

Wholesale

Listed in numerical order

SUGGESTED LIST PRICES

MODEL NUMBER	LIST PRICE	PAGE NO.	UNIVERSAL PRODUCT CODE	CASE QTY	MODEL NUMBER	LIST PRICE	PAGE NO.	UNIVERSAL PRODUCT CODE	CASE QTY
TS22002	728.30	165	026508242452	3	TS43002BL	1,156.50	159	026508302125	3
TS22002EP	728.30	165	026508242476	3	TS43003	789.10	159	026508242650	3
TS22002BL	1,170.00	166	026508301876	3	TS43003BL	1,183.65	159	026508281932	3
TS22002EPBL	1,170.00	165	026508301883	3	TS44102	534.30	182	026508310601	3
TS22003	871.90	165	026508242513	3	TS44102BN	694.60	182	026508310632	3
TS22003EP	871.90	165	026508242537	3	TS44102BL	748.05	182	026508310625	3
TS22003BL	1,391.30	166	026508301890	3	TS44102BG	774.75	182	026508310618	3
TS22003EPBL	1,391.30	165	026508301906	3	TS44103	559.80	182	026508310649	3
TS22101	1,140.80	148	026508215654	3	TS44103BN	727.75	182	026508310670	3
TS22101BG	1,614.60	148	026508291078	3	TS44103BL	783.75	182	026508310663	3
TS22101BN	1,614.60	148	026508215661	3	TS44103BG	811.75	182	026508310656	3
TS22101NL	1,614.60	148	026508231234	3	TS44104	561.10	182	026508310687	3
TS22101BL	1,742.00	148	026508301913	3	TS44104BN	729.40	182	026508310717	3
TS22101ORB	1,742.00	148	026508215678	3	TS44104BL	785.50	182	026508310700	3
TS22103	1,140.80	148	026508215685	3	TS44104BG	813.55	182	026508310694	3
TS22103BG	1,614.60	148	026508286326	3	TS44105	586.60	182	026508310724	3
TS22103BN	1,614.60	148	026508215692	3	TS44105BN	762.55	182	026508310755	3
TS22103NL	1,614.60	148	026508231241	3	TS44105BL	821.20	182	026508310748	3
TS22103BL	1,742.00	148	026508301920	3	TS44105BG	850.55	182	026508310731	3
TS22103ORB	1,742.00	148	026508215708	3	TS44201	274.35	190	026508310809	3
TS25105	968.90	147	026508251119	1	TS44201BG	411.60	190	026508310816	3
TS25105BN	1,404.75	147	026508251126	1	TS44201BN	411.60	190	026508310830	3
TS25105BL	1,453.35	147	-	1	TS44201BL	452.75	190	026508310823	3
TS25105NL	1,501.80	147	026508337462	1	TS44401	384.50	185	026508311004	3
TS25105ORB	1,545.25	147	026508282014	1	TS44401BG	576.70	185	026508311011	3
TS25105BG	1,550.25	147	026508373255	1	TS44401BN	576.70	185	026508311035	3
TS32100	862.15	157	026508300480	4	TS44401BL	634.45	185	026508311028	3
TS32100BG	1,219.15	157	026508300497	4	TS44402	177.50	185	026508311042	6
TS32100BN	1,219.15	157	026508300510	4	TS44402BG	266.30	185	026508311059	6
TS32100NL	1,219.15	157	026508300527	4	TS44402BN	266.30	185	026508311073	6
TS32100BL	1,315.70	157	026508300503	4	TS44402BL	292.90	185	026508311066	6
TS32100ORB	1,315.70	157	026508300534	4	TS44503	990.05	184	026508311080	3
TS32102	766.85	155	026508215722	3	TS44503BG	1,435.55	184	026508311097	3
TS32102EP	766.85	155	026508218877	3	TS44503BN	1,435.55	184	026508311110	3
TS32102BG	1,119.30	155	026508286333	3	TS44503BL	1,579.05	184	026508311103	3
TS32102BN	1,119.30	155	026508215739	3	TS44504	1,198.50	184	026508311127	3
TS32102EPBG	1,119.30	155	026508286340	3	TS44504BG	1,737.90	184	026508311134	3
TS32102EPBN	1,119.30	155	026508218884	3	TS44504BN	1,737.90	184	026508311158	3
TS32102EPNL	1,119.30	155	026508231258	3	TS44504BL	1,911.70	184	026508311141	3
TS32102NL	1,119.30	155	026508231272	3	TS44505	1,015.55	184	026508311165	3
TS32102BL	1,207.45	155	026508299180	3	TS44505BG	1,461.05	184	026508311172	3
TS32102EPBL	1,207.45	155	026508299173	3	TS44505BN	1,461.05	184	026508311196	3
TS32102EPORB	1,207.45	155	026508218891	3	TS44505BL	1,604.60	184	026508311189	3
TS32102ORB	1,207.45	155	026508215777	3	TS44506	1,224.00	184	026508311202	3
TS32104	935.10	155	026508215784	3	TS44506BG	1,763.40	184	026508311219	3
TS32104EP	935.10	155	026508218914	3	TS44506BN	1,763.40	184	026508311233	3
TS32104BG	1,311.90	155	026508286357	3	TS44506BL	1,937.20	184	026508311226	3
TS32104BN	1,311.90	155	026508215791	3	TS50100	400.90	463	026508251133	2
TS32104EPBG	1,311.90	155	026508286364	3	TS50110	325.95	463	026508258231	2
TS32104EPBN	1,311.90	155	026508218921	3	TS50200	601.45	463	026508251140	2
TS32104EPNL	1,311.90	155	026508231289	3	TS50210	488.90	463	026508258248	2
TS32104NL	1,311.90	155	026508231302	3	TS52104	252.45	149	026508216071	6
TS32104BL	1,415.45	155	026508299159	3	TS52104BG	348.75	149	026508286449	6
TS32104EPBL	1,415.45	155	026508299142	3	TS52104BN	348.75	149	026508216088	6
TS32104EPORB	1,415.45	155	026508218938	3	TS52104NL	348.75	149	026508231395	6
TS32104ORB	1,415.45	155	026508215838	3	TS52104BL	376.05	149	026508302132	6
TS32110	486.25	149	026508215869	3	TS52104ORB	376.05	149	026508216095	6
TS32110BG	715.70	149	026508286388	3	TS93003	1,004.20	160	026508242735	3
TS32110BN	715.70	149	026508215876	3	TS93003BL	1,597.55	160	026508302149	3
TS32110NL	715.70	149	026508231326	3	TS93004	1,533.35	160	026508242759	3
TS32110BL	772.05	149	026508302002	3	TS93004BL	3,008.05	160	026508302156	3
TS32110ORB	772.05	149	026508215883	3	TV6507	538.20	218	026508373699	3
TS33002	399.80	161	026508242599	3	TV6507BN	672.75	218	026508373705	3
TS33002BL	659.80	161	026508302033	3	TV6507BL	726.55	218	026508373729	3
TS33003	228.40	161	026508242612	6	TV6507BG	780.40	218	026508373712	3
TS33003BL	366.60	161	026508302040	6	U130CI	71.20	465	026508319390	6
TS42108	828.20	145	026508215982	3	U130CX	71.20	465	026508319413	6
TS42108BN	1,118.05	145	026508215999	3	U130X	71.20	465	026508319437	6
TS42108BL	1,159.45	145	026508302095	3	U130CIS	102.45	465	026508319406	6
TS42108NL	1,200.85	145	026508231364	3	U130CXS	102.45	465	026508319420	6
TS42108BG	1,242.25	145	026508286425	3	U130XS	102.45	465	026508319444	6
TS42108ORB	1,242.25	145	026508216002	3	U140CI	71.20	465	026508319451	6
TS42112	847.50	146	026508216019	3	U140CX	71.20	465	026508319475	6
TS42112BN	1,101.70	146	026508216026	3	U140X	71.20	465	026508319536	6
TS42112BL	1,144.10	146	026508302101	3	U140CX-PF	80.40	465	026508319482	3
TS42112NL	1,186.45	146	026508231371	3	U140X-PF	80.40	466	026508319543	3
TS42112BG	1,228.85	146	026508286432	3	U140V	87.20	465	026508319512	6
TS42112ORB	1,228.85	146	026508216033	3	U140CIS	102.45	465	026508319468	6
TS42114	828.20	145	026508216040	3	U140CXS	102.45	465	026508319499	6
TS42114BN	1,118.05	145	026508216057	3	U140XS	102.45	466	026508319550	6
TS42114BL	1,159.45	145	026508302118	3	U140CXS-PF	111.70	465	026508319505	3
TS42114NL	1,200.85	145	026508231388	3	U140XS-PF	111.70	466	026508319567	3
TS42114ORB	1,242.25	145	026508216064	3	U140VS	118.50	465	026508319529	6
TS42114BG	1,283.70	145	026508286467	3	U231CI	149.70	466	026508319574	6
TS43002	771.00	159	026508242636	3	U231CX	149.70	466	026508319581	6

Wholesale

Listed in numerical order

MODEL NUMBER	LIST PRICE	PAGE NO.	UNIVERSAL PRODUCT CODE	CASE QTY
U231X	149.70	466	026508319598	6
U232CIS	265.40	466	026508319604	6
U232CXS	265.40	466	026508319611	6
U232XS	265.40	466	026508319628	6
U361CI	149.70	466	026508319635	6
U361CX	149.70	466	026508319642	6
U361X	149.70	466	026508319659	6
U362CIS	265.40	466	026508319666	6
U362CXS	265.40	466	026508319673	6
U362XS	265.40	466	026508319680	6
U8350	255.30	659	026508319697	3
UT2011	188.60	321	026508319703	12
UT2011BN	229.05	321	026508319710	12
UT2011ORB	244.80	321	026508319727	12
UT2021	188.60	312	026508319734	12
UT2021BN	229.05	312	026508319741	12
UT2021ORB	244.80	312	026508319758	12
UT2031	188.60	299	026508319765	12
UT2031BN	229.05	299	026508319772	12
UT2031BL	244.80	299	026508337073	12
UT2031ORB	244.80	299	026508319789	12
UT2081	227.70	256	026508319826	12
UT2081BL	300.85	256	026508319833	12
UT2131	177.75	323	026508338094	3
UT2131BN	282.70	323	026508338100	3
UT2131ORB	298.85	323	026508338117	3
UT2132NH	182.60	323	026508338155	3
UT2132EP	186.55	323	026508338124	12
UT2132NHBN	292.40	323	026508338162	3
UT2132NHORB	309.60	323	026508338179	3
UT2132EPBN	321.00	323	026508338131	12
UT2132EPORB	341.00	323	026508338148	12
UT2133NH	208.95	322	026508338216	3
UT2133EP	225.75	322	026508338186	4
UT2133NHBN	323.00	322	026508338223	3
UT2133NHORB	337.30	322	026508338230	3
UT2133EPBN	385.00	322	026508338193	4
UT2133EPORB	411.55	322	026508338209	4
UT2151	177.75	314	026508338247	3
UT2151BN	282.70	314	026508338254	3
UT2151ORB	298.85	314	026508338261	3
UT2152NH	182.60	314	026508338308	3
UT2152EP	186.55	314	026508338278	12
UT2152NHBN	292.40	314	026508338315	3
UT2152NHORB	309.60	314	026508338322	3
UT2152EPBN	321.00	314	026508338285	12
UT2152EPORB	341.00	314	026508338292	12
UT2153NH	220.00	313	026508338360	3
UT2153EP	225.75	313	026508338339	3
UT2153NHBN	312.10	313	026508338377	3
UT2153NHORB	337.30	313	026508338384	3
UT2153EPBN	385.00	313	026508338346	3
UT2153EPORB	411.55	313	026508338353	3
UT2181	177.75	301	026508338391	3
UT2181BN	282.70	301	026508338407	3
UT2181BL	298.85	301	026508343258	3
UT2181ORB	298.85	301	026508338414	3
UT2182EP	186.55	300	026508338421	12
UT2182EPBN	321.00	300	026508338438	12
UT2182EPBL	341.00	300	026508343265	12
UT2182EPORB	341.00	300	026508338445	12
UT2183EP	225.75	300	026508338452	12
UT2183EPBN	385.00	300	026508338469	12
UT2183EPBL	411.55	300	026508343272	12
UT2183EPORB	411.55	300	026508338476	12
UT2191	293.05	248	026508338483	3
UT2191BG	429.15	248	026508338490	3
UT2191BN	429.15	248	026508338513	3
UT2191BL	459.55	248	026508338506	3
UT2192NH	303.00	247	026508338568	3
UT2192EP	348.50	247	026508338520	12
UT2192NHBG	447.45	247	026508338575	3
UT2192NHBN	447.45	247	026508338599	3
UT2192NHBL	479.65	247	026508338582	3
UT2192EPBG	530.65	247	026508338537	12
UT2192EPBN	530.65	247	026508338551	12
UT2192EPBL	571.15	247	026508338544	12
UT2193NH	316.75	247	026508338643	3
UT2193EP	409.10	247	026508338605	3
UT2193NHBG	498.75	247	026508338650	3
UT2193NHBN	498.75	247	026508338674	3
UT2193NHBL	536.10	247	026508338667	3
UT2193EPBG	640.40	247	026508338612	3
UT2193EPBN	640.40	247	026508338636	3
UT2193EPBL	691.75	247	026508338629	3

MODEL NUMBER	LIST PRICE	PAGE NO.	UNIVERSAL PRODUCT CODE	CASE QTY
UT2232EP	265.45	323	026508338681	4
UT2232EPBN	370.60	323	026508338698	4
UT2232EPORB	390.10	323	026508338704	4
UT2233EP	307.05	322	026508338711	4
UT2233EPBN	433.30	322	026508338728	4
UT2233EPORB	459.25	322	026508338735	4
UT2252EP	265.45	314	026508338742	4
UT2252EPBN	370.60	314	026508338759	4
UT2252EPORB	390.10	314	026508338766	4
UT2253EP	307.05	313	026508338773	4
UT2253EPBN	433.30	313	026508338780	4
UT2253EPORB	459.25	313	026508338797	4
UT2261	281.20	280	026508336281	3
UT2261BG	411.90	280	026508336298	3
UT2261BN	411.90	280	026508336311	3
UT2261BL	441.05	280	026508336304	3
UT2262EP	334.50	280	026508336328	4
UT2262EPBG	509.30	280	026508336335	4
UT2262EPBN	509.30	280	026508336359	4
UT2262EPBL	548.15	280	026508336342	4
UT2263EP	392.65	280	026508336366	4
UT2263EPBG	614.50	280	026508336373	4
UT2263EPBN	614.50	280	026508336397	4
UT2263EPBL	663.85	280	026508336380	4
UT2282EP	265.45	300	026508338803	4
UT2282EPBN	370.60	300	026508338810	4
UT2282EPBL	390.10	300	026508343289	4
UT2282EPORB	390.10	300	026508338827	4
UT2283EP	307.05	300	026508338834	4
UT2283EPBN	433.30	300	026508338841	4
UT2283EPBL	459.25	300	026508343296	4
UT2283EPORB	459.25	300	026508338858	4
UT2311	286.95	268	026508338865	3
UT2311BN	418.10	268	026508338872	3
UT2311NL	418.10	268	026508338889	3
UT2311BL	430.45	268	026508371442	3
UT2311ORB	447.35	268	026508338896	3
UT2312EP	340.45	268	026508338902	4
UT2312EPBN	515.95	268	026508338919	3
UT2312EPNL	515.95	268	026508338926	4
UT2312EPBL	527.70	268	026508371459	4
UT2312EPORB	554.75	268	026508338933	4
UT2313EP	398.60	268	026508338940	4
UT2313EPBN	621.55	268	026508338957	4
UT2313EPNL	621.55	268	026508338964	4
UT2313EPBL	637.80	268	026508371466	4
UT2313EPORB	671.35	268	026508338971	4
UT2321	293.05	225	026508365021	3
UT2321BG	429.15	225	026508365199	3
UT2321BN	429.15	225	026508365045	3
UT2321BL	459.55	225	026508365007	3
UT2322EP	348.50	225	026508365014	3
UT2322EPBG	530.65	225	026508365120	3
UT2322EPBN	530.65	225	026508364949	3
UT2322EPBL	571.15	225	026508365168	3
UT2323EP	409.10	225	026508365250	3
UT2323EPBG	640.40	225	026508365076	3
UT2323EPBN	640.40	225	026508364987	3
UT2323EPBL	691.75	225	026508365281	3
UT2401	183.70	344	026508319857	12
UT2401BN	229.05	344	026508319871	12
UT2401BL	244.80	344	026508319864	12
UT2471	186.90	346	026508339107	3
UT2471BN	257.00	346	026508339121	3
UT2471BL	270.75	346	026508339114	3
UT2472NH	189.20	345	026508339169	3
UT2472EP	192.80	345	026508339138	12
UT2472NHBN	261.70	345	026508339183	3
UT2472EPBN	269.00	345	026508339152	12
UT2472NHBL	275.80	345	026508339176	3
UT2472EPBL	283.90	345	026508339145	12
UT2473NH	213.80	345	026508339220	3
UT2473EP	229.50	345	026508339190	12
UT2473NHBN	306.55	345	026508339244	3
UT2473NHBL	325.15	345	026508339237	3
UT2473EPBN	330.35	345	026508339213	12
UT2473EPBL	351.35	345	026508339206	12
UT2661	189.85	331	026508339251	3
UT2662NH	192.20	330	026508339275	3
UT2662EP	195.95	330	026508339268	1
UT2663NH	217.85	330	026508339299	3
UT2663EP	234.25	330	026508339282	12
UT2691	281.20	291	026508339305	3
UT2691BG	411.90	291	026508339312	3
UT2691BN	411.90	291	026508339329	3

Wholesale

Listed in numerical order

SUGGESTED LIST PRICES

MODEL NUMBER	LIST PRICE	PAGE NO.	UNIVERSAL PRODUCT CODE	CASE QTY	MODEL NUMBER	LIST PRICE	PAGE NO.	UNIVERSAL PRODUCT CODE	CASE QTY
UT2691NL	411.90	291	026508339336	3	UT3293BG	847.10	245	026508320105	4
UT2691BL	421.85	291	026508373002	3	UT3293BN	847.10	245	026508320129	4
UT2691ORB	441.05	291	026508339343	3	UT3293EPBG	847.10	245	026508320143	4
UT2692EP	334.50	291	026508339350	12	UT3293EPBN	847.10	245	026508320167	4
UT2692EPBG	509.30	291	026508339367	12	UT3293BL	931.80	245	026508320112	4
UT2692EPBN	509.30	291	026508339374	12	UT3293EPBL	931.80	245	026508320150	4
UT2692EPNL	509.30	291	026508339381	12	UT3311	320.75	266	026508320174	3
UT2692EPBL	518.45	291	026508373057	12	UT3311BN	547.80	266	026508320181	3
UT2692EPORB	548.05	291	026508339398	12	UT3311NL	547.80	266	026508320198	3
UT2693EP	392.65	291	026508339404	3	UT3311BL	561.25	266	026508371497	3
UT2693EPBG	614.50	291	026508339411	3	UT3311ORB	587.45	266	026508320204	3
UT2693EPBN	614.50	291	026508339428	3	UT3312	389.85	265	026508320211	4
UT2693EPNL	614.50	291	026508339435	3	UT3312EP	389.85	265	026508320235	4
UT2693EPBL	628.25	291	026508372951	3	UT3312BN	644.10	265	026508320228	4
UT2693EPORB	664.15	291	026508339442	3	UT3312EPBN	644.10	265	026508320242	4
UT2721	188.60	305	026508319888	12	UT3312EPNL	644.10	265	026508320259	4
UT2721BN	229.05	305	026508319895	12	UT3312NL	644.10	265	026508320273	4
UT2721BL	244.80	305	026508339708	12	UT3312BL	662.75	265	026508371503	4
UT2741	177.75	307	026508339459	3	UT3312EPBL	662.75	265	026508371510	4
UT2741BN	282.70	307	026508339473	3	UT3312EPORB	730.95	265	026508320266	4
UT2741BL	298.85	307	026508339466	3	UT3312ORB	730.95	265	026508320280	4
UT2742EP	186.55	306	026508339480	12	UT3313	481.30	265	026508320297	4
UT2742EPBN	321.00	306	026508339503	12	UT3313EP	481.30	265	026508320310	4
UT2742EPBL	341.00	306	026508339497	12	UT3313BN	812.50	265	026508320303	4
UT2743EP	225.75	306	026508339510	3	UT3313EPBN	812.50	265	026508320327	4
UT2743EPBN	385.00	306	026508339534	3	UT3313EPNL	812.50	265	026508320334	4
UT2743EPBL	411.50	306	026508339527	3	UT3313NL	812.50	265	026508320358	4
UT2811	293.05	419	026508339541	3	UT3313BL	842.25	265	026508371534	4
UT2811BL	459.50	419	026508339558	3	UT3313EPBL	842.25	265	026508371527	4
UT2812NH	303.00	257	026508339602	3	UT3313EPORB	920.05	265	026508320341	4
UT2812EP	348.50	257	026508339572	12	UT3313ORB	920.05	265	026508320365	4
UT2812NHBL	479.65	257	026508339619	3	UT3322	328.90	267	026508320372	4
UT2812EPBL	571.10	257	026508339589	12	UT3322BN	407.75	267	026508320389	4
UT2813NH	316.75	257	026508339664	3	UT3322NL	407.75	267	026508320396	4
UT2813EP	409.10	257	026508339633	12	UT3322BL	427.55	267	026508371473	4
UT2813NHBL	536.00	257	026508339671	3	UT3322ORB	438.65	267	026508320402	4
UT2813EPBL	691.75	257	026508339640	12	UT3331	315.65	279	026508336403	4
UT2842EP	265.45	306	026508339695	4	UT3331BG	391.30	279	026508336410	4
UT2842EPBN	370.60	306	026508339718	4	UT3331BN	391.30	279	026508336434	4
UT2842EPBL	390.10	306	026508339701	4	UT3331BL	430.45	279	026508336427	4
UT2843EP	307.05	306	026508339725	4	UT3361	334.00	278	026508336441	3
UT2843EPBN	433.30	306	026508339749	4	UT3361BG	548.25	278	026508336458	3
UT2843EPBL	459.25	306	026508339732	4	UT3361BN	548.25	278	026508336472	3
UT2901	189.85	337	026508339756	3	UT3361BL	603.05	278	026508336465	3
UT2901BN	263.35	337	026508339770	3	UT3362	397.50	278	026508336489	3
UT2901BL	277.70	337	026508339763	3	UT3362EP	397.50	278	026508336526	3
UT2902NH	192.20	337	026508339817	3	UT3362BG	667.95	278	026508336496	3
UT2902EP	195.95	337	026508339787	12	UT3362BN	667.95	278	026508336519	3
UT2902NHBN	268.25	337	026508339831	3	UT3362EPBG	667.95	278	026508336533	3
UT2902EPBN	275.85	337	026508339800	12	UT3362EPBN	667.95	278	026508336557	3
UT2902NHBL	283.10	337	026508339824	3	UT3362BL	734.75	278	026508336502	3
UT2902EPBL	291.45	337	026508339794	12	UT3362EPBL	734.75	278	026508336540	3
UT2903NH	217.85	336	026508339879	3	UT3363	487.85	278	026508336564	3
UT2903EP	234.25	336	026508339848	12	UT3363EP	487.85	278	026508336601	3
UT2903NHBN	315.05	336	026508339893	3	UT3363BG	812.95	278	026508336571	3
UT2903NHBL	334.55	336	026508339886	3	UT3363BN	812.95	278	026508336595	3
UT2903EPBN	335.10	336	026508339862	12	UT3363EPBG	812.95	278	026508336618	3
UT2903EPBL	356.60	336	026508339855	12	UT3363EPBN	812.95	278	026508336632	3
UT2921	188.60	335	026508319901	12	UT3363BL	894.30	278	026508336588	3
UT2921BN	229.40	335	026508319925	12	UT3363EPBL	894.30	278	026508336625	3
UT2921BL	245.30	335	026508319918	12	UT3611	315.60	289	026508320419	4
UT3002EP	249.80	337	026508339909	4	UT3611BG	391.30	289	026508320426	4
UT3002EPBN	350.60	337	026508339923	4	UT3611BN	391.30	289	026508320440	4
UT3002EPBL	373.55	337	026508339916	4	UT3611NL	391.30	289	026508324738	4
UT3003EP	288.20	336	026508339930	4	UT3611BL	410.30	289	026508320433	4
UT3003EPBN	436.75	336	026508339954	4	UT3611ORB	420.95	289	026508320457	4
UT3003EPBL	468.45	336	026508339947	4	UT3691	334.00	289	026508320464	3
UT3290	328.90	246	026508319932	4	UT3691BG	548.25	289	026508320471	3
UT3290BG	407.75	246	026508319949	4	UT3691BN	548.25	289	026508320488	3
UT3290BN	407.75	246	026508319963	4	UT3691NL	548.25	289	026508320495	3
UT3290BL	448.55	246	026508319956	4	UT3691BL	551.10	289	026508371183	3
UT3291	348.05	245	026508319970	3	UT3691ORB	588.85	289	026508320501	3
UT3291BG	571.30	245	026508319987	3	UT3692	397.50	288	026508320518	4
UT3291BN	571.30	245	026508320006	3	UT3692EP	397.50	288	026508320549	4
UT3291BL	628.40	245	026508319994	3	UT3692BG	667.95	288	026508320525	4
UT3292	414.15	245	026508320013	4	UT3692BN	667.95	288	026508320532	4
UT3292EP	414.15	245	026508320051	4	UT3692EPBG	667.95	288	026508320556	4
UT3292BG	696.00	245	026508320020	4	UT3692EPBN	667.95	288	026508320563	4
UT3292BN	696.00	245	026508320044	4	UT3692EPNL	667.95	288	026508320570	4
UT3292EPBG	696.00	245	026508320068	4	UT3692NL	667.95	288	026508320594	4
UT3292EPBN	696.00	245	026508320082	4	UT3692BL	675.70	288	026508371190	4
UT3292BL	765.60	245	026508320037	4	UT3692EPBL	675.70	288	026508371206	4
UT3292EPBL	765.60	245	026508320075	4	UT3692EPORB	720.35	288	026508320587	4
UT3293	508.35	245	026508320099	4	UT3692ORB	720.35	288	026508320600	4
UT3293EP	508.35	245	026508320136	4	UT3693	487.85	288	026508320617	4

Wholesale

Listed in numerical order

MODEL NUMBER	LIST PRICE	PAGE NO.	UNIVERSAL PRODUCT CODE	CASE QTY
UT3693EP	487.85	288	026508320648	4
UT3693BG	812.95	288	026508320624	4
UT3693BN	812.95	288	026508320631	4
UT3693EPBG	812.95	288	026508320655	4
UT3693EPBN	812.95	288	026508320662	4
UT3693EPNL	812.95	288	026508320679	4
UT3693NL	812.95	288	026508320693	4
UT3693BL	829.30	288	026508371213	4
UT3693EPBL	829.30	288	026508371220	4
UT3693EPORB	879.75	288	026508320686	4
UT3693ORB	879.75	288	026508320709	4
UT3811	348.05	255	026508325209	3
UT3811BL	613.50	255	026508325216	3
UT3812EP	414.15	255	026508325230	4
UT3812EPBL	750.55	255	026508325247	4
UT3813EP	508.35	255	026508325261	4
UT3813EPBL	916.70	255	026508325278	4
UT4191	227.70	246	026508320716	12
UT4191BG	280.30	246	026508320723	12
UT4191BN	280.30	246	026508320747	12
UT4191BL	300.80	246	026508320730	12
UT4291	483.05	244	026508347089	3
UT4291BG	706.30	244	026508347096	3
UT4291BN	706.30	244	026508347119	3
UT4291BL	763.40	244	026508347102	3
UT4292EP	549.15	244	026508347126	4
UT4292EPBG	831.00	244	026508347133	4
UT4292EPBN	831.00	244	026508347157	4
UT4292EPBL	900.60	244	026508347140	4
UT4293EP	643.35	244	026508346464	4
UT4293EPBG	982.10	244	026508347164	4
UT4293EPBN	982.10	244	026508347188	4
UT4293EPBL	1,066.80	244	026508347171	4
UT4301	222.00	267	026508320754	12
UT4301BN	272.75	267	026508320761	12
UT4301NL	272.75	267	026508320778	12
UT4301BL	277.50	267	026508371480	12
UT4301ORB	292.45	267	026508320785	12
UT4311	455.75	264	026508347195	3
UT4311BN	682.80	264	026508347201	3
UT4311NL	682.80	264	026508347218	3
UT4311BL	696.25	264	026508371565	3
UT4311ORB	722.45	264	026508347225	3
UT4312EP	524.85	264	026508347232	4
UT4312EPBN	779.10	264	026508347249	4
UT4312EPNL	779.10	264	026508347256	4
UT4312EPBL	797.75	264	026508371572	4
UT4312EPORB	865.95	264	026508347263	4
UT4313EP	616.30	264	026508347270	4
UT4313EPBN	947.50	264	026508347287	4
UT4313EPNL	947.50	264	026508347294	4
UT4313EPBL	977.25	264	026508372128	4
UT4313EPORB	1,055.05	264	026508347300	4
UT4321	483.05	221	026508364956	3
UT4321BG	706.30	221	026508365274	3
UT4321BN	706.30	221	026508365366	3
UT4321BL	763.40	221	026508365359	3
UT4322EP	549.15	221	026508365373	4
UT4322EPBG	831.00	221	026508365311	4
UT4322EPBN	831.00	221	026508364994	4
UT4322EPBL	900.60	221	026508365380	4
UT4323EP	643.35	221	026508365397	4
UT4323EPBG	982.10	221	026508365144	4
UT4323EPBN	982.10	221	026508365052	4
UT4323EPBL	1,066.80	221	026508365403	4
UT4361	469.00	277	026508359471	3
UT4361BG	683.25	277	026508359488	3
UT4361BN	683.25	277	026508359501	3
UT4361BL	738.05	277	026508359495	3
UT4362EP	532.50	277	026508359518	3
UT4362EPBG	802.95	277	026508359525	3
UT4362EPBN	802.95	277	026508359549	3
UT4362EPBL	869.75	277	026508359532	3
UT4363EP	622.85	277	026508359556	3
UT4363EPBG	947.95	277	026508359563	3
UT4363EPBN	947.95	277	026508359587	3
UT4363EPBL	1,029.30	277	026508359570	3
UT4511	227.70	235	026508320792	12
UT4511BN	280.30	235	026508320808	12
UT4511ORB	300.80	235	026508320822	12
UT4611	218.50	290	026508320839	12
UT4611BG	268.95	290	026508320846	12
UT4611BN	268.95	290	026508320853	12
UT4611NL	268.95	290	026508320860	12
UT4611BL	284.05	290	026508372975	12

MODEL NUMBER	LIST PRICE	PAGE NO.	UNIVERSAL PRODUCT CODE	CASE QTY
UT4611ORB	288.65	290	026508320877	12
UT4620	218.50	279	026508336649	12
UT4620BG	268.95	279	026508336656	12
UT4620BN	268.95	279	026508336670	12
UT4620BL	288.65	279	026508336663	12
UT4691	469.00	287	026508348383	3
UT4691BG	683.25	287	026508348390	3
UT4691BN	683.25	287	026508348406	3
UT4691NL	683.25	287	026508348413	3
UT4691BL	686.10	287	026508371268	3
UT4691ORB	723.85	287	026508348420	3
UT4692EP	532.50	287	026508348437	4
UT4692EPBG	802.95	287	026508348444	4
UT4692EPBN	802.95	287	026508348451	4
UT4692EPNL	802.95	287	026508348468	4
UT4692EPBL	810.70	287	026508371275	4
UT4692EPORB	855.35	287	026508348475	4
UT4693EP	622.85	287	026508348482	4
UT4693EPBG	947.95	287	026508348499	4
UT4693EPBN	947.95	287	026508348505	4
UT4693EPNL	947.95	287	026508348512	4
UT4693EPBL	964.30	287	026508371282	4
UT4693EPORB	1,014.75	287	026508348529	4
UT4811	483.05	254	026508348536	3
UT4811BL	748.50	254	026508348543	3
UT4812EP	549.15	254	026508348557	4
UT4812EPBL	885.55	254	026508348574	4
UT4813EP	643.35	254	026508348598	4
UT4813EPBL	1,051.70	254	026508348604	4
UT5500	320.90	235	026508320884	4
UT5500BN	407.75	235	026508320891	4
UT5500ORB	438.65	235	026508320914	4
UT6501	227.70	224	026508364888	12
UT6501BG	280.30	224	026508364895	12
UT6501BN	280.30	224	026508364918	12
UT6501BL	300.80	224	026508364901	12
UT8350	189.70	659	026508321126	3
UT8350CBN	243.45	659	026508321133	3
UT24501	293.05	236	026508338988	3
UT24501BN	429.15	236	026508338995	3
UT24501ORB	459.55	236	026508339015	3
UT24502EP	348.50	236	026508339022	3
UT24502EPBN	530.65	236	026508339039	3
UT24502EPORB	571.05	236	026508339053	3
UT24503EP	409.10	236	026508339060	3
UT24503EPBN	640.40	236	026508339077	3
UT24503EPORB	692.05	236	026508339091	3
UT33321	348.05	223	026508365243	3
UT33321BG	571.30	223	026508365113	3
UT33321BN	571.30	223	026508365298	3
UT33321BL	628.40	223	026508365212	3
UT33322EP	414.15	222	026508365328	4
UT33322EPBG	696.00	222	026508365236	4
UT33322EPBN	696.00	222	026508365304	4
UT33322EPBL	696.00	222	026508365090	4
UT33322EPORB	696.00	222	026508365083	4
UT33323EP	696.00	222	026508365267	4
UT33323EPBG	765.60	222	026508365069	4
UT33323EPBL	765.60	222	026508364963	4
UT33323EPBN	508.35	222	026508365137	4
UT33323EPNL	508.35	222	026508365229	4
UT33323EPORB	847.10	222	026508365335	4
UT33324EP	847.10	222	026508365205	4
UT33324EPBG	847.10	222	026508365175	4
UT33324EPBN	847.10	222	026508364970	4
UT33324EPBL	931.80	222	026508364932	4
UT33324EPORB	931.80	222	026508365182	4
UT33341	328.90	224	026508365038	4
UT33341BG	407.75	224	026508365342	4
UT33341BN	407.75	224	026508365151	4
UT33341BL	448.55	224	026508365106	4
UT35501	348.05	234	026508323014	3
UT35501BN	571.30	234	026508323021	3
UT35501ORB	613.50	234	026508323045	3
UT35502	414.15	234	026508323052	4
UT35502EP	414.15	234	026508323076	4
UT35502EPBN	696.00	234	026508323069	4
UT35502EPBL	696.00	234	026508323083	4
UT35502EPORB	750.55	234	026508323106	4
UT35503	508.35	234	026508323120	4
UT35503EP	508.35	234	026508323137	4
UT35503EPBN	847.10	234	026508323151	4
UT35503EPBL	847.10	234	026508323144	4
UT35503EPORB	847.10	234	026508323168	4
UT35504EPORB	916.70	234	026508323182	4

Wholesale

Listed in numerical order

SUGGESTED LIST PRICES

MODEL NUMBER	LIST PRICE	PAGE NO.	UNIVERSAL PRODUCT CODE	CASE QTY
UT35503ORB	916.70	234	026508323205	4
UT45501	483.05	233	026508348260	3
UT45501BN	706.30	233	026508348277	3
UT45501ORB	748.50	233	026508348291	3
UT45502EP	549.15	233	026508348307	4
UT45502EPBN	831.00	233	026508348314	4
UT45502EPORB	885.55	233	026508348338	4
UT45503EP	643.35	233	026508348345	4
UT45503EPBN	982.10	233	026508348352	4
UT45503EPORB	1,051.70	233	026508348376	4
UTL170	203.15	598	026508321140	3
UTL171	209.20	598	026508321157	12
UTL171EP	209.20	598	026508321164	12
UTL172	251.45	598	026508321171	12
UTL172EP	251.45	598	026508321188	12
UTL181	153.30	353	026508339961	3
UTL182NH	155.15	352	026508340004	12
UTL182EP	157.75	352	026508339985	12
UTL183NH	178.60	352	026508340035	12
UTL183EP	188.30	352	026508340011	12
UTS2201	401.15	214	026508340134	3
UTS2201BN	513.85	214	026508340158	3
UTS2201BL	550.05	214	026508340141	3
UTS2202EP	484.60	214	026508340165	4
UTS2202EPBN	634.60	214	026508340189	4
UTS2202EPBL	683.05	214	026508340172	4
UTS2203EP	575.15	214	026508340196	4
UTS2203EPBN	766.00	214	026508340219	4
UTS2203EPBL	827.35	214	026508340202	4
UTS2411	508.65	176	026508321232	4
UTS2411BG	737.50	176	026508321249	4
UTS2411BN	737.50	176	026508321256	4
UTS2411NL	737.50	176	026508321263	4
UTS2611	444.25	213	026508321270	4
UTS2611BN	644.15	213	026508321294	4
UTS2611BL	708.55	213	026508321287	4
UTS2711	380.15	200	026508340523	3
UTS2711BN	581.40	200	026508340530	3
UTS2711BL	589.20	200	026508371046	3
UTS2712EP	459.05	200	026508340547	4
UTS2712EPBN	727.70	200	026508340554	4
UTS2712EPBL	757.45	200	026508371053	4
UTS2713EP	544.55	200	026508340561	4
UTS2713EPBN	886.15	200	026508340578	4
UTS2713EPBL	898.55	200	026508371060	4
UTS2911	437.85	177	026508340615	3
UTS2911BG	581.30	177	026508340622	3
UTS2911BN	581.30	177	026508340639	3
UTS2911NL	581.30	177	026508340646	3
UTS2912EP	585.15	177	026508340653	4
UTS2912EPBG	802.25	177	026508340660	4
UTS2912EPBN	802.25	177	026508340677	4
UTS2912EPNL	802.25	177	026508340684	4
UTS2913EP	703.10	177	026508340691	4
UTS2913EPBG	979.10	177	026508340707	4
UTS2913EPBN	979.10	177	026508340714	4
UTS2913EPNL	979.10	177	026508340721	4
UTS3201	451.50	212	026508321461	3
UTS3201BN	569.30	212	026508321485	3
UTS3201BL	607.30	212	026508321478	3
UTS3202	544.35	212	026508321492	4
UTS3202EP	544.35	212	026508321522	4
UTS3202BN	726.25	212	026508321515	4
UTS3202EPBN	726.25	212	026508321546	4
UTS3202BL	819.50	212	026508321508	4
UTS3202EPBL	819.50	212	026508321539	4
UTS3203	645.85	212	026508321553	4
UTS3203EP	645.85	212	026508321584	4
UTS3203BN	888.85	212	026508321577	4
UTS3203EPBN	888.85	212	026508321607	4
UTS3203BL	1,002.10	212	026508321560	4
UTS3203EPBL	1,002.10	212	026508321591	4
UTS3311	503.10	164	026508321973	4
UTS3311BL	1,094.95	164	026508321980	4
UTS3711	435.20	198	026508322000	3
UTS3711BN	814.30	198	026508322017	3
UTS3711BL	826.85	198	026508371077	3
UTS3713	641.40	198	026508322024	4
UTS3713EP	641.40	198	026508322048	4
UTS3713BN	1,229.30	198	026508322031	4
UTS3713EPBN	1,229.30	198	026508322055	4
UTS3713BL	1,250.75	198	026508371084	4
UTS3713EPBL	1,250.75	198	026508371091	4
UTS3715	520.10	198	026508322062	4
UTS3715EP	520.10	198	026508322086	4

MODEL NUMBER	LIST PRICE	PAGE NO.	UNIVERSAL PRODUCT CODE	CASE QTY
UTS3715BN	1,002.00	198	026508322079	4
UTS3715EPBN	1,002.00	198	026508322093	4
UTS3715BL	1,014.20	198	026508371107	4
UTS3715EPBL	1,014.20	198	026508371114	4
UTS3911	545.20	175	026508322109	3
UTS3911BG	723.05	175	026508322116	3
UTS3911BN	723.05	175	026508322123	3
UTS3911NL	723.05	175	026508322130	3
UTS3912	648.50	175	026508322147	4
UTS3912EP	648.50	175	026508322178	4
UTS3912BG	897.20	175	026508322154	4
UTS3912BN	897.20	175	026508322161	4
UTS3912EPBG	897.20	175	026508322185	4
UTS3912EPBN	897.20	175	026508322192	4
UTS3912EPNL	897.20	175	026508322208	4
UTS3912NL	897.20	175	026508322215	4
UTS3913	772.95	175	026508322222	4
UTS3913EP	772.95	175	026508322253	4
UTS3913BG	1,096.55	175	026508322239	4
UTS3913BN	1,096.55	175	026508322246	4
UTS3913EPBG	1,096.55	175	026508322260	4
UTS3913EPBN	1,096.55	175	026508322277	4
UTS3913EPNL	1,096.55	175	026508322284	4
UTS3913NL	1,096.55	175	026508322291	4
UTS4172	297.50	199	026508322307	12
UTS4172BN	370.40	199	026508322314	12
UTS4172BL	386.75	199	026508371121	12
UTS4201	586.50	211	026508348710	3
UTS4201BN	704.30	211	026508348734	3
UTS4201BL	742.30	211	026508348727	3
UTS4202EP	679.35	211	026508348741	4
UTS4202EPBN	861.25	211	026508348765	4
UTS4202EPBL	954.50	211	026508348758	4
UTS4203EP	780.85	211	026508348772	4
UTS4203EPBN	1,023.85	211	026508348796	4
UTS4203EPBL	1,137.10	211	026508348789	4
UTS4311	738.70	153	026508322321	4
UTS4311BG	1,071.10	153	026508322338	4
UTS4311BN	1,071.10	153	026508322352	4
UTS4311NL	1,071.10	153	026508322369	4
UTS4311BL	1,178.20	153	026508322345	4
UTS4311ORB	1,178.20	153	026508322376	4
UTS4711	570.20	197	026508347317	3
UTS4711BN	949.30	197	026508349106	3
UTS4711BL	961.85	197	026508371138	3
UTS4713EP	776.40	197	026508349113	4
UTS4713EPBN	1,364.30	197	026508349120	4
UTS4713EPBL	1,385.75	197	026508371145	4
UTS4715EP	655.10	197	026508349137	4
UTS4715EPBN	1,137.00	197	026508349144	4
UTS4715EPBL	1,149.20	197	026508371152	4
UTS4910	680.20	174	026508349182	3
UTS4910BG	858.05	174	026508349199	3
UTS4910BN	858.05	174	026508349205	3
UTS4910NL	858.05	174	026508349212	3
UTS4911	330.70	176	026508322581	12
UTS4911BG	449.10	176	026508322598	12
UTS4911BN	449.10	176	026508322604	12
UTS4911NL	449.10	176	026508322611	12
UTS4912EP	783.50	174	026508349229	4
UTS4912EPBG	1,032.20	174	026508349236	4
UTS4912EPBN	1,032.20	174	026508349243	4
UTS4912EPNL	1,032.20	174	026508349250	4
UTS4913EP	907.95	174	026508349267	4
UTS4913EPBG	1,231.55	174	026508349274	4
UTS4913EPBN	1,231.55	174	026508349281	4
UTS4913EPNL	1,231.55	174	026508349298	4
UTS9011	420.40	199	026508322628	4
UTS9011BN	608.70	199	026508322635	4
UTS9011BL	630.60	199	026508371169	4
UTS9204	314.10	213	026508322642	12
UTS9204BN	413.15	213	026508322666	12
UTS9204BL	445.10	213	026508322659	12
UTS9211	485.70	188	026508322673	4
UTS9211BG	704.30	188	026508322680	4
UTS9211BN	704.30	188	026508322703	4
UTS9211BL	774.70	188	026508322697	4
UTS9381	315.90	188	026508322710	12
UTS9381BG	428.85	188	026508322727	12
UTS9381BN	428.85	188	026508322741	12
UTS9381BL	471.75	188	026508322734	12
UTS22001	486.45	165	026508340042	3
UTS22001BL	724.05	165	026508340059	3
UTS22002EP	841.05	165	026508340073	3
UTS22002EPBL	1,282.75	165	026508340080	3

Wholesale

Listed in numerical order

MODEL NUMBER	LIST PRICE	PAGE NO.	UNIVERSAL PRODUCT CODE	CASE QTY
UTS22003EP	984.65	165	026508340103	3
UTS22003EPBL	1,504.05	165	026508340110	3
UTS23005	434.20	164	026508321201	12
UTS23005BL	557.70	164	026508321218	12
UTS23210	514.80	154	026508340226	3
UTS23210BG	681.50	154	026508340356	3
UTS23210BN	681.50	154	026508340370	3
UTS23210NL	681.50	154	026508340387	3
UTS23210BL	726.50	154	026508340363	3
UTS23210ORB	726.50	154	026508340394	3
UTS32001	567.60	163	026508321317	3
UTS32001BL	809.15	163	026508321324	3
UTS32002	888.70	163	026508321348	3
UTS32002EP	888.70	163	026508321379	3
UTS32002BL	1,376.05	163	026508321355	3
UTS32002EPBL	1,376.05	163	026508321386	3
UTS32003	1,006.30	163	026508321409	3
UTS32003EP	1,006.30	163	026508321430	3
UTS32003BL	1,577.45	163	026508321416	4
UTS32003EPBL	1,577.45	163	026508321447	3
UTS32205	459.95	153	026508321614	12
UTS32205BG	525.60	153	026508321621	12
UTS32205BN	525.60	153	026508321645	12
UTS32205NL	525.60	153	026508321652	12
UTS32205BL	559.50	153	026508321638	12
UTS32205ORB	559.50	153	026508321669	12
UTS33101	615.75	152	026508321676	3
UTS33101BG	790.40	152	026508321683	3
UTS33101BN	790.40	152	026508321706	3
UTS33101NL	790.40	152	026508321713	3
UTS33101BL	838.50	152	026508321690	3
UTS33101ORB	838.50	152	026508321720	3
UTS33102	922.20	151	026508321737	3
UTS33102EP	922.20	151	026508321775	3
UTS33102BG	1,280.85	151	026508321744	3
UTS33102BN	1,280.85	151	026508321768	3
UTS33102EPBG	1,280.85	151	026508321782	3
UTS33102EPBN	1,280.85	151	026508321805	3
UTS33102EPNL	1,280.85	151	026508321812	3
UTS33102NL	1,280.85	151	026508321836	3
UTS33102BL	1,408.75	151	026508321751	3
UTS33102EPBL	1,408.75	151	026508321799	3
UTS33102EPORB	1,408.75	151	026508321829	3
UTS33102ORB	1,408.75	151	026508321843	3
UTS33103	1,057.05	151	026508321850	3
UTS33103EP	1,057.05	151	026508321898	3
UTS33103BG	1,449.80	151	026508321867	3
UTS33103BN	1,449.80	151	026508321881	3
UTS33103EPBG	1,449.80	151	026508321904	3
UTS33103EPBN	1,449.80	151	026508321928	3
UTS33103EPNL	1,449.80	151	026508321935	3
UTS33103NL	1,449.80	151	026508321959	3
UTS33103BL	1,596.85	151	026508321874	3
UTS33103EPBL	1,596.85	151	026508321911	3
UTS33103EPORB	1,596.85	151	026508321942	3
UTS33103ORB	1,596.85	151	026508321966	3
UTS42001	702.60	162	026508348628	3
UTS42001BL	944.15	162	026508348635	3
UTS42002EP	1,023.70	162	026508348659	3
UTS42002EPBL	1,511.05	162	026508348666	3
UTS42003EP	1,141.30	162	026508348680	3
UTS42003EPBL	1,712.45	162	026508348697	3
UTS43101	750.75	150	026508348802	3
UTS43101BG	925.40	150	026508348819	3
UTS43101BN	925.40	150	026508348833	3
UTS43101NL	925.40	150	026508348840	3
UTS43101BL	973.50	150	026508348826	3
UTS43101ORB	973.50	150	026508348857	3
UTS43102EP	1,057.20	150	026508348864	3
UTS43102EPBG	1,415.85	150	026508348871	3
UTS43102EPBN	1,415.85	150	026508348895	3
UTS43102EPNL	1,415.85	150	026508348901	3
UTS43102EPBL	1,543.75	150	026508348888	3
UTS43102EPORB	1,543.75	150	026508348918	3
UTS43103EP	1,192.05	150	026508348925	3
UTS43103EPBG	1,584.80	150	026508348932	3
UTS43103EPBN	1,584.80	150	026508348956	3
UTS43103EPNL	1,584.80	150	026508348963	3
UTS43103EPBL	1,731.85	150	026508348949	3
UTS43103EPORB	1,731.85	150	026508348970	3
UTS232102EP	879.65	154	026508340233	3
UTS232102EPBG	1,232.15	154	026508340240	3
UTS232102EPBN	1,232.15	154	026508340264	3
UTS232102EPNL	1,232.15	154	026508340271	3
UTS232102EPBL	1,320.20	154	026508340257	3

MODEL NUMBER	LIST PRICE	PAGE NO.	UNIVERSAL PRODUCT CODE	CASE QTY
UTS232102EPORB	1,320.20	154	026508340288	3
UTS232104EP	1,047.80	154	026508340295	3
UTS232104EPBG	1,424.65	154	026508340301	3
UTS232104EPBN	1,424.65	154	026508340325	3
UTS232104EPNL	1,424.65	154	026508340332	3
UTS232104EPBL	1,528.25	154	026508340318	3
UTS232104EPORB	1,528.25	154	026508340349	3
UTS244201	425.35	189	026508340400	3
UTS244201BG	562.60	189	026508340417	3
UTS244201BN	562.60	189	026508340431	3
UTS244201BL	603.75	189	026508340424	3
UTS244202EP	566.30	189	026508340448	3
UTS244202EPBG	773.90	189	026508340455	3
UTS244202EPBN	773.90	189	026508340479	3
UTS244202EPBL	836.15	189	026508340462	3
UTS244203EP	679.05	189	026508340486	3
UTS244203EPBG	943.10	189	026508340493	3
UTS244203EPBN	943.10	189	026508340516	3
UTS244203EPBL	1,022.30	189	026508340509	3
UTS344301	520.65	187	026508323212	3
UTS344301BG	690.50	187	026508323229	3
UTS344301BN	690.50	187	026508323243	3
UTS344301BL	759.50	187	026508323236	3
UTS344302	619.35	187	026508323250	3
UTS344302EP	619.35	187	026508323298	3
UTS344302BG	856.75	187	026508323267	3
UTS344302BN	856.75	187	026508323281	3
UTS344302EPBG	856.75	187	026508323304	3
UTS344302EPBN	856.75	187	026508323328	3
UTS344302BL	942.50	187	026508323274	3
UTS344302EPBL	942.50	187	026508323311	3
UTS344303	738.15	187	026508323335	3
UTS344303EP	738.15	187	026508323373	3
UTS344303BG	1,047.25	187	026508323342	3
UTS344303BN	1,047.25	187	026508323366	3
UTS344303EPBG	1,047.25	187	026508323380	3
UTS344303EPBN	1,047.25	187	026508323403	3
UTS344303BL	1,151.95	187	026508323359	3
UTS344303EPBL	1,151.95	187	026508323397	3
UTS444301	655.65	186	026508348987	3
UTS444301BG	825.50	186	026508348994	3
UTS444301BN	825.50	186	026508349014	3
UTS444301BL	894.50	186	026508349007	3
UTS444302EP	754.35	186	026508349021	3
UTS444302EPBG	991.75	186	026508349038	3
UTS444302EPBN	991.75	186	026508349052	3
UTS444302EPBL	1,077.50	186	026508349045	3
UTS444303EP	873.15	186	026508349069	3
UTS444303EPBG	1,182.25	186	026508349076	3
UTS444303EPBN	1,182.25	186	026508349090	3
UTS444303EPBL	1,286.95	186	026508349083	3
WIACC001G1USA	60.00	53	026508365984	12
WICNT008G1USA	270.00	53	026508366059	1
WICNT016G1USA	352.50	53	026508366011	1
WISNS002G1USA	105.00	53	026508365991	3
WMV130CIS	151.05	463	026508353134	6
WMV130CXS	151.05	463	026508353141	6
WMV130XS	151.05	463	026508353158	6
WT371	435.00	304	026508353059	3
WT371BN	574.20	304	026508353172	3
WT371BL	631.60	304	026508353165	3
WT391	720.25	241	026508353189	3
WT391BG	965.15	241	026508353196	3
WT391BN	965.15	241	026508353219	3
WT391BL	1,061.60	241	026508353202	3
WT621	720.25	219	026508372425	3
WT621BG	965.15	219	026508372432	3
WT621BN	965.15	219	026508372456	3
WT621BL	1,061.60	219	026508372449	3
WT681	435.00	297	026508353264	3
WT681BN	574.20	297	026508353288	3
WT681BL	631.60	297	026508353271	3
WT681ORB	631.60	297	026508353295	3
WT691	650.00	285	026508353066	3
WT691BG	897.00	285	026508353301	3
WT691BN	897.00	285	026508353318	3
WT691NL	897.00	285	026508353325	3
WT691BL	943.30	285	026508371305	3
WT691ORB	986.70	285	026508353332	3
WT901	474.10	342	026508353349	3
WT901BN	606.85	342	026508353363	3
WT901BL	667.55	342	026508353356	3
WT961	474.10	334	026508353417	3
WT961BN	616.35	334	026508353431	3
WT961BL	678.00	334	026508353424	3

Wholesale

Listed in numerical order

SUGGESTED LIST PRICES

MODEL NUMBER	LIST PRICE	PAGE NO.	UNIVERSAL PRODUCT CODE	CASE QTY	MODEL NUMBER	LIST PRICE	PAGE NO.	UNIVERSAL PRODUCT CODE	CASE QTY
WT6221	698.75	275	026508353226	3	YB0305BG	28.50	179	034584031655	48
WT6221BG	943.30	275	026508353233	3	YB0307CH	36.60	179	034584031716	48
WT6221BN	943.30	275	026508353257	3	YB0307BN	47.65	179	034584031709	48
WT6221BL	1,037.65	275	026508353240	3	YB0307NL	52.40	179	034584031723	48
WT9021	630.00	262	026508353370	3	YB0307BG	57.20	179	034584031693	48
WT9021BN	875.70	262	026508353387	3	YB0308CH	127.80	179	034584031167	6
WT9021NL	875.70	262	026508353394	3	YB0308BN	166.05	179	034584031150	6
WT9021BL	914.30	262	026508372142	3	YB0308NL	182.70	179	034584031174	6
WT9021ORB	963.30	262	026508353400	3	YB0308BG	199.35	179	034584031730	6
WTS911	790.25	195	026508353073	3	YB0318CH	147.05	179	034584031204	6
WTS911BN	1,114.25	195	026508353486	3	YB0318BN	191.05	179	034584031198	6
WTS911BL	1,145.85	195	026508371176	3	YB0318NL	210.15	179	034584031211	6
WTS921	800.00	171	026508353493	3	YB0318BG	229.35	179	034584031181	6
WTS921BG	1,120.00	171	026508353509	3	YB0322CH	142.55	179	034584031242	6
WTS921NL	1,120.00	171	026508353523	3	YB0322BN	185.25	179	034584031235	6
WTS921BN	1,220.80	171	026508353516	3	YB0322NL	203.90	179	034584031259	6
WTS981	790.25	208	026508353530	3	YB0322BG	222.45	179	034584031228	6
WTS981BN	987.80	208	026508353554	3	YB0324CH	152.10	179	034584031280	6
WTS981BL	1,086.60	208	026508353547	3	YB0324BN	197.80	179	034584031273	6
WTS44501	812.05	183	026508353448	3	YB0324NL	217.50	179	034584031297	6
WTS44501BG	1,112.50	183	026508353455	3	YB0324BG	237.35	179	034584031266	6
WTS44501BN	1,112.50	183	026508353479	3	YB0361CH	232.80	181	034584031327	2
WTS44501BL	1,223.75	183	026508353462	3	YB0361BN	302.60	181	034584031310	2
Y5703CH	19.75	484	034584033239	12	YB0361NL	332.85	181	034584031334	2
Y5703BN	23.70	484	034584032973	12	YB0361BG	363.10	181	034584031303	2
Y5703BL	28.50	484	034584032317	12	YB0362CH	325.65	181	034584031365	2
Y5708CH	24.60	484	034584033246	3	YB0362BN	423.35	181	034584031358	2
Y5708BN	28.90	484	034584032980	3	YB0362NL	465.75	181	034584031372	2
Y5708BL	34.65	484	034584032324	3	YB0362BG	508.10	181	034584031341	2
Y5709CH	33.05	484	034584034250	3	YB0363CH	404.50	181	034584030306	2
Y5709BN	37.45	484	034584034243	3	YB0363BN	525.80	181	034584030290	2
Y5709BL	43.35	484	034584034236	3	YB0363NL	578.35	181	034584030303	2
Y5718CH	43.25	484	034584033253	3	YB0363BG	630.95	181	034584030283	2
Y5718BN	49.45	484	034584032997	3	YB0364CH	505.60	181	034584030344	2
Y5718BL	62.30	484	034584032331	3	YB0364BN	657.30	181	034584030337	2
Y5722CH	73.50	484	034584034281	3	YB0364NL	722.95	181	034584030351	2
Y5722BN	81.55	484	034584034274	3	YB0364BG	788.60	181	034584030320	2
Y5722BL	105.90	484	034584034267	3	YB0369	40.10	181	034584030368	3
Y5724CH	47.00	484	034584033260	3	YB0386CH	102.70	179	034584030399	6
Y5724BN	54.40	484	034584033000	3	YB0386BN	133.50	179	034584030382	6
Y5724BL	67.60	484	034584032348	3	YB0386NL	146.90	179	034584030405	6
Y5785CH	33.35	484	034584034311	3	YB0386BG	160.25	179	034584030375	6
Y5785BN	37.55	484	034584034304	3	YB0390CH	141.20	179	034584030436	6
Y5785BL	42.25	484	034584034298	3	YB0390BN	183.50	179	034584030429	6
Y5786CH	23.05	484	034584033277	3	YB0390NL	201.80	179	034584030443	6
Y5786BN	27.00	484	034584033017	3	YB0390BG	220.15	179	034584030412	6
Y5786BL	31.50	484	034584032355	3	YB0392CH	347.60	179	034584030474	1
Y5788CH	42.45	484	034584034342	3	YB0392BN	417.05	179	034584030467	1
Y5788BN	50.95	484	034584034335	3	YB0392NL	458.80	179	034584030481	1
Y5788BL	61.15	484	034584034328	3	YB0392BG	500.45	179	034584030450	1
Y5794CH	193.10	484	034584034366	2	YB0402CH	65.55	251	034584022547	24
Y5794BN	193.30	484	034584034359	2	YB0402BN	74.65	251	034584022530	24
Y5794BL	219.05	484	034584032881	2	YB0402BL	81.90	251	034584026750	24
YB0201CH	79.50	217	034584028389	24	YB0403CH	36.25	251	034584022561	24
YB0201BN	85.75	217	034584028372	24	YB0403BN	39.90	251	034584022554	24
YB0201BL	94.35	217	034584028365	24	YB0403BL	43.80	251	034584026767	24
YB0203CH	60.90	217	034584028419	24	YB0403BG	47.90	251	034584028594	24
YB0203BN	65.30	217	034584028402	24	YB0408CH	66.15	251	034584022585	6
YB0203BL	71.65	217	034584028396	24	YB0408BN	73.15	251	034584022578	6
YB0208CH	112.10	217	034584028440	6	YB0408BL	80.45	251	034584026774	6
YB0208BN	120.85	217	034584028433	6	YB0408BG	106.10	251	034584028600	6
YB0208BL	132.90	217	034584028426	6	YB0409CH	56.30	251	034584022608	6
YB0218CH	128.80	217	034584028471	6	YB0409BN	61.95	251	034584022592	6
YB0218BN	139.15	217	034584028464	6	YB0409BL	68.10	251	034584026781	6
YB0218BL	153.00	217	034584028457	6	YB0418CH	76.80	251	034584022622	6
YB0224CH	133.45	217	034584028501	6	YB0418BN	84.45	251	034584022615	6
YB0224BN	144.25	217	034584028495	6	YB0418BL	92.85	251	034584026798	6
YB0224BL	158.75	217	034584028488	6	YB0418BG	118.25	251	034584028617	6
YB0275CH	80.10	217	034584028303	6	YB0424CH	79.20	251	034584022646	6
YB0275BN	88.15	217	034584028297	6	YB0424BN	87.45	251	034584022639	6
YB0275BL	97.45	217	034584028280	6	YB0424BL	96.15	251	034584026804	6
YB0286CH	89.95	217	034584028891	6	YB0424BG	122.30	251	034584028624	6
YB0286BN	97.05	217	034584028884	6	YB0486CH	53.90	251	034584022660	6
YB0286BL	106.75	217	034584028877	6	YB0486BN	58.95	251	034584022653	6
YB0301CH	90.60	179	034584031570	24	YB0486BL	64.85	251	034584026811	6
YB0301BN	117.75	179	034584031587	24	YB0486BG	85.45	251	034584028648	6
YB0301NL	129.55	179	034584031594	24	YB0501CH	90.65	191	034584032423	24
YB0301BG	141.35	179	034584031648	24	YB0501BN	117.85	191	034584032416	9
YB0303CH	69.45	179	034584031631	24	YB0501BL	129.65	191	034584032409	24
YB0303BN	90.35	179	034584031624	24	YB0501BG	136.05	191	034584032393	24
YB0303NL	99.30	179	034584031600	24	YB0503CH	69.50	191	034584032461	24
YB0303BG	108.40	179	034584031617	24	YB0503BN	90.35	191	034584032454	24
YB0305CH	18.25	179	034584031679	48	YB0503BL	99.40	191	034584032447	24
YB0305NL	20.10	179	034584031686	48	YB0503BG	104.20	191	034584032430	24
YB0305BN	23.75	179	034584031662	48	YB0505CH	18.25	191	034584032508	48

Wholesale

Listed in numerical order

MODEL NUMBER	LIST PRICE	PAGE NO.	UNIVERSAL PRODUCT CODE	CASE QTY	MODEL NUMBER	LIST PRICE	PAGE NO.	UNIVERSAL PRODUCT CODE	CASE QTY
YB0505BN	23.75	191	034584032492	48	YB1763BG	461.70	228	034584037824	1
YB0505BL	26.20	191	034584032485	48	YB1764CH	394.10	228	034584037893	1
YB0505BG	27.45	191	034584032478	48	YB1764BN	492.65	228	034584037886	1
YB0507CH	36.65	191	034584032546	48	YB1764BL	537.00	228	034584037879	1
YB0507BN	47.70	191	034584032539	48	YB1764BG	591.15	228	034584037862	1
YB0507BL	52.40	191	034584032522	48	YB1769	32.45	228	034584037909	3
YB0507BG	55.05	191	034584032515	48	YB1786CH	53.90	227	034584037947	6
YB0508CH	127.80	191	034584032584	6	YB1786BN	58.95	227	034584037930	6
YB0508BN	166.15	191	034584032577	6	YB1786BL	64.85	227	034584037923	6
YB0508BL	182.85	191	034584032560	6	YB1786BG	85.45	227	034584037916	6
YB0508BG	191.75	191	034584032553	6	YB1788CH	95.90	227	034584037985	3
YB0518CH	147.05	191	034584032621	6	YB1788BN	106.10	227	034584037978	3
YB0518BN	191.15	191	034584032614	6	YB1788BL	116.65	227	034584037961	3
YB0518BL	210.30	191	034584032607	6	YB1788BG	153.85	227	034584037954	3
YB0518BG	220.55	191	034584032591	6	YB1794CH	312.10	227	034584038029	2
YB0524CH	152.25	191	034584032669	6	YB1794BN	342.30	227	034584038012	2
YB0524BN	197.90	191	034584032652	6	YB1794BL	373.15	227	034584038005	2
YB0524BL	217.65	191	034584032645	6	YB1794BG	445.00	227	034584037992	2
YB0524BG	228.35	191	034584032638	6	YB2101CH	25.00	303	034584024992	24
YB0561CH	232.90	192	034584032706	2	YB2101BN	40.10	303	034584024985	24
YB0561BN	302.70	192	034584032690	2	YB2101BL	44.15	303	034584033512	24
YB0561BL	333.00	192	034584032683	2	YB2101ORB	44.15	303	034584025005	24
YB0561BG	349.35	192	034584032676	2	YB2103CH	18.65	303	034584025029	24
YB0562CH	325.90	192	034584032744	2	YB2103BN	28.40	303	034584025012	24
YB0562BN	423.65	192	034584032737	2	YB2103BL	31.20	303	034584033529	24
YB0562BL	466.00	192	034584032720	2	YB2103ORB	31.20	303	034584025036	24
YB0562BG	488.90	192	034584032713	2	YB2108CH	33.25	303	034584025050	6
YB0563CH	404.70	192	034584032782	2	YB2108BN	51.15	303	034584025043	6
YB0563BN	526.05	192	034584032775	2	YB2108BL	56.15	303	034584033536	6
YB0563BL	578.65	192	034584032768	2	YB2108ORB	56.15	303	034584025067	6
YB0563BG	607.00	192	034584032751	2	YB2118CH	40.80	303	034584025098	6
YB0564CH	505.80	192	034584032829	2	YB2118BN	62.70	303	034584025074	6
YB0564BN	657.55	192	034584032812	2	YB2118BL	68.90	303	034584033543	6
YB0564BL	723.30	192	034584032805	2	YB2118ORB	68.90	303	034584025081	6
YB0564BG	758.75	192	034584032799	2	YB2124CH	43.05	303	034584025111	6
YB0569	41.95	192	034584032836	3	YB2124BN	65.95	303	034584025104	6
YB0586CH	102.70	191	034584032874	6	YB2124BL	72.40	303	034584033550	6
YB0586BN	133.60	191	034584032867	6	YB2124ORB	72.40	303	034584025128	6
YB0586BL	146.95	191	034584032850	6	YB2186CH	25.40	303	034584025142	6
YB0586BG	154.10	191	034584032843	6	YB2186BN	38.65	303	034584025135	6
YB0801CH	112.25	168	034584021717	24	YB2186BL	42.65	303	034584033567	6
YB0801BL	135.90	168	034584021710	24	YB2186ORB	42.65	303	034584025159	6
YB0803CH	107.80	168	034584021731	24	YB2201CH	25.00	317	034584008015	6
YB0803BL	130.65	168	034584021724	24	YB2201BN	40.10	317	034584008008	6
YB0808CH	153.40	168	034584021755	6	YB2201ORB	44.15	317	034584008022	6
YB0808BL	185.80	168	034584021748	6	YB2203CH	18.65	317	034584008046	24
YB0818CH	177.60	168	034584021779	6	YB2203BN	28.40	317	034584008039	24
YB0818BL	215.10	168	034584021772	6	YB2203ORB	31.20	317	034584008053	24
YB0824CH	191.65	168	034584021793	6	YB2208CH	33.25	317	034584008077	6
YB0824BL	232.15	168	034584021786	6	YB2208BN	51.15	317	034584008060	6
YB0886CH	124.05	168	034584021816	6	YB2208ORB	56.15	317	034584008084	6
YB0886BL	150.15	168	034584021809	6	YB2218CH	40.80	317	034584008107	6
YB0892CH	309.25	168	034584021830	3	YB2218BN	62.70	317	034584008091	6
YB0892BL	374.50	168	034584021823	3	YB2218ORB	68.90	317	034584008114	6
YB1701CH	47.10	227	034584037572	24	YB2224CH	43.05	317	034584008138	6
YB1701BN	52.00	227	034584037565	24	YB2224BN	65.95	317	034584008121	6
YB1701BL	56.70	227	034584037558	24	YB2224ORB	72.40	317	034584008145	6
YB1701BG	67.60	227	034584037541	24	YB2261CH	147.20	318	034584022233	2
YB1703CH	36.25	227	034584037619	24	YB2261BN	184.10	318	034584022226	2
YB1703BN	39.90	227	034584037602	24	YB2261ORB	184.10	318	034584022240	2
YB1703BL	43.80	227	034584037596	24	YB2262CH	206.10	318	034584022264	2
YB1703BG	47.90	227	034584037589	24	YB2262BN	257.70	318	034584022257	2
YB1708CH	66.15	227	034584037657	6	YB2262ORB	257.70	318	034584022271	2
YB1708BN	73.15	227	034584037640	6	YB2263CH	255.90	318	034584022295	2
YB1708BL	80.45	227	034584037633	6	YB2263BN	319.95	318	034584022288	2
YB1708BG	106.10	227	034584037626	6	YB2263ORB	319.95	318	034584022301	2
YB1718CH	76.80	227	034584037695	6	YB2264CH	327.80	318	034584022325	2
YB1718BN	84.45	227	034584037688	6	YB2264BN	409.65	318	034584022318	2
YB1718BL	92.85	227	034584037671	6	YB2264ORB	409.65	318	034584022332	2
YB1718BG	118.25	227	034584037664	6	YB2269	27.60	318	034584022349	3
YB1724CH	79.20	227	034584037732	6	YB2286CH	25.40	317	034584008169	6
YB1724BN	87.45	227	034584037725	6	YB2286BN	38.65	317	034584008152	6
YB1724BL	96.15	227	034584037718	6	YB2286ORB	42.65	317	034584008176	6
YB1724BG	122.30	227	034584037701	6	YB2303CH	18.65	309	034584024602	24
YB1761CH	177.10	228	034584037770	1	YB2303BN	28.40	309	034584024596	24
YB1761BN	221.45	228	034584037763	1	YB2303BL	31.20	309	034584033185	24
YB1761BL	241.40	228	034584037756	1	YB2308CH	33.25	309	034584024626	6
YB1761BG	265.80	228	034584037749	1	YB2308BN	51.15	309	034584024619	6
YB1762CH	247.80	228	034584037817	1	YB2308BL	56.15	309	034584033192	6
YB1762BN	309.75	228	034584037800	1	YB2318CH	40.80	309	034584024640	6
YB1762BL	337.60	228	034584037794	1	YB2318BN	62.70	309	034584024633	6
YB1762BG	371.70	228	034584037787	1	YB2318BL	68.90	309	034584033208	6
YB1763CH	307.80	228	034584037855	1	YB2324CH	43.05	309	034584024664	6
YB1763BN	384.70	228	034584037848	1	YB2324BN	65.95	309	034584024657	6
YB1763BL	419.30	228	034584037831	1	YB2324BL	72.40	309	034584033215	6

Wholesale

Listed in numerical order

SUGGESTED LIST PRICES

MODEL NUMBER	LIST PRICE	PAGE NO.	UNIVERSAL PRODUCT CODE	CASE QTY	MODEL NUMBER	LIST PRICE	PAGE NO.	UNIVERSAL PRODUCT CODE	CASE QTY
YB2386CH	25.40	309	034584024688	6	YB5164CH	394.10	296	034584023933	2
YB2386BN	38.65	309	034584024671	6	YB5164BL	492.65	296	034584038234	2
YB2386BL	42.65	309	034584033222	6	YB5164BN	492.65	296	034584023926	2
YB2801CH	25.00	327	034584005601	6	YB5164ORB	492.65	296	034584023940	2
YB2801BN	40.10	327	034584005663	6	YB5164NL	532.65	296	034584029782	2
YB2801ORB	44.15	327	034584005724	6	YB5164BG	591.15	296	034584028754	2
YB2803CH	18.65	327	034584005557	24	YB5169	32.45	296	034584023957	3
YB2803BN	28.40	327	034584005618	24	YB5186CH	51.70	294	034584020802	6
YB2803ORB	31.20	327	034584005670	24	YB5186BN	56.60	294	034584020796	6
YB2808CH	33.25	327	034584005564	6	YB5186ORB	57.65	294	034584020819	6
YB2808BN	51.15	327	034584005625	6	YB5186BL	61.65	294	034584038258	6
YB2808ORB	56.15	327	034584005687	6	YB5186NL	62.70	294	034584029744	6
YB2818CH	40.80	327	034584005571	6	YB5186BG	81.95	294	034584028747	6
YB2818BN	62.70	327	034584005632	6	YB5201CH	47.10	239	034584023087	6
YB2818ORB	68.90	327	034584005694	6	YB5201BN	52.00	239	034584023094	6
YB2824CH	43.05	327	034584005588	6	YB5201ORB	57.10	239	034584023575	6
YB2824BN	65.95	327	034584005649	6	YB5203CH	36.25	239	034584023100	24
YB2824ORB	72.40	327	034584005700	6	YB5203BN	39.90	239	034584023117	24
YB2861CH	147.20	328	034584022363	2	YB5203ORB	43.80	239	034584023599	24
YB2861BN	184.10	328	034584022356	2	YB5208CH	66.15	239	034584023124	6
YB2861ORB	184.10	328	034584022370	2	YB5208BN	73.15	239	034584023131	6
YB2862CH	206.10	328	034584022394	2	YB5208ORB	80.50	239	034584023612	6
YB2862BN	257.70	328	034584022387	2	YB5218CH	76.80	239	034584023148	6
YB2862ORB	257.70	328	034584022400	2	YB5218BN	84.45	239	034584023155	6
YB2863CH	255.90	328	034584022424	2	YB5218ORB	92.85	239	034584023636	6
YB2863BN	319.95	328	034584022417	2	YB5222CH	105.15	239	034584023162	6
YB2863ORB	319.95	328	034584022431	2	YB5222BN	110.85	239	034584023179	6
YB2864CH	327.80	328	034584022455	2	YB5222ORB	116.35	239	034584023650	6
YB2864BN	409.65	328	034584022448	2	YB5224CH	79.20	239	034584023186	6
YB2864ORB	409.65	328	034584022462	2	YB5224BN	87.45	239	034584023193	6
YB2869	27.60	328	034584022479	3	YB5224ORB	96.25	239	034584023674	6
YB2886CH	25.40	327	034584005595	6	YB5275CH	163.90	239	034584023544	6
YB2886BN	38.65	327	034584005656	6	YB5275BN	187.50	239	034584023537	6
YB2886ORB	42.65	327	034584005717	6	YB5275ORB	203.20	239	034584023551	6
YB2894CH	198.45	327	034584015143	2	YB5286CH	53.90	239	034584023209	6
YB2894BN	217.65	327	034584015136	2	YB5286BN	58.95	239	034584023216	6
YB2894ORB	239.35	327	034584015150	2	YB5286ORB	64.85	239	034584023698	6
YB5101CH	45.20	294	034584020628	24	YB5401CH	49.10	493	034584006127	24
YB5101BN	49.90	294	034584020611	24	YB5401BN	54.20	493	034584006103	24
YB5101NL	54.70	294	034584029607	24	YB5401ORB	59.55	493	034584001184	24
YB5101BL	54.80	294	034584038159	24	YB5401WR	59.55	493	034584006134	24
YB5101ORB	54.80	294	034584020635	24	YB5403CH	37.80	493	034584482761	24
YB5101BG	59.85	294	034584028631	24	YB5403BN	41.65	493	034584483003	24
YB5103CH	34.80	294	034584020659	24	YB5403ORB	45.70	493	034584000330	24
YB5103BN	38.30	294	034584020642	24	YB5403WR	45.70	493	034584483089	24
YB5103ORB	38.90	294	034584020666	24	YB5405CH	11.70	493	034584018168	48
YB5103BL	42.00	294	034584038166	24	YB5405BN	14.65	493	034584018151	48
YB5103NL	42.05	294	034584029591	24	YB5405ORB	15.60	493	034584018502	48
YB5103BG	45.95	294	034584028846	24	YB5407CH	23.25	493	034584018182	48
YB5108CH	63.50	294	034584020680	6	YB5407BN	28.95	493	034584018175	48
YB5108BN	70.25	294	034584020673	6	YB5407ORB	31.50	493	034584018519	48
YB5108ORB	71.60	294	034584020697	6	YB5408CH	69.05	493	034584482778	6
YB5108BL	77.35	294	034584038173	6	YB5408BN	76.40	493	034584483010	6
YB5108NL	82.60	294	034584029584	6	YB5408ORB	84.00	493	034584000347	6
YB5108BG	101.85	294	034584028839	6	YB5408WR	84.00	493	034584483096	6
YB5118CH	73.65	294	034584020710	6	YB5418CH	74.15	493	034584482785	6
YB5118BN	81.05	294	034584020703	6	YB5418BN	81.60	493	034584483027	6
YB5118ORB	82.50	294	034584020727	6	YB5418ORB	89.70	493	034584000606	6
YB5118BL	89.10	294	034584038180	6	YB5418WR	89.70	493	034584483102	6
YB5118NL	89.25	294	034584029577	6	YB5422CH	99.35	493	034584015693	6
YB5118BG	113.45	294	034584028822	6	YB5422BN	107.15	493	034584015686	6
YB5124CH	76.05	294	034584020741	6	YB5422ORB	117.90	493	034584015709	6
YB5124BN	83.90	294	034584020734	6	YB5422WR	117.90	493	034584015716	6
YB5124BL	92.40	294	034584038197	6	YB5424CH	76.60	493	034584482792	6
YB5124ORB	92.40	294	034584020758	6	YB5424BN	84.50	493	034584483034	6
YB5124NL	94.25	294	034584029683	6	YB5424ORB	93.00	493	034584000613	6
YB5124BG	117.40	294	034584028815	6	YB5424WR	93.00	493	034584483119	6
YB5161CH	177.10	296	034584023841	2	YB5486CH	52.05	493	034584482822	6
YB5161BL	221.45	296	034584038203	2	YB5486BN	57.00	493	034584483065	6
YB5161BN	221.45	296	034584023834	2	YB5486ORB	62.70	493	034584000644	6
YB5161ORB	221.45	296	034584023858	2	YB5486WR	62.70	493	034584483140	6
YB5161NL	221.55	296	034584029751	2	YB5490CH	98.60	493	034584482839	3
YB5161BG	265.80	296	034584028792	2	YB5490BN	106.00	493	034584483072	3
YB5162CH	247.80	296	034584023872	2	YB5490ORB	116.75	493	034584000651	3
YB5162BL	309.75	296	034584038210	2	YB5490WR	126.10	493	034584483157	3
YB5162BN	309.75	296	034584023865	2	YB5494CH	268.45	493	034584015082	2
YB5162ORB	309.75	296	034584023889	2	YB5494BN	295.90	493	034584015075	2
YB5162NL	322.55	296	034584029768	2	YB5494ORB	325.45	493	034584015099	2
YB5162BG	371.70	296	034584028778	2	YB6401CH	45.35	271	034584027047	24
YB5163CH	307.80	296	034584023902	2	YB6401BN	50.05	271	034584027030	24
YB5163BL	384.70	296	034584038227	2	YB6401NL	54.90	271	034584029737	24
YB5163BN	384.70	296	034584023896	2	YB6401BL	55.05	271	034584038265	24
YB5163ORB	384.70	296	034584023919	2	YB6401ORB	55.05	271	034584027054	24
YB5163NL	415.90	296	034584029775	2	YB6403CH	34.90	271	034584027078	24
YB5163BG	461.70	296	034584028761	2	YB6403BN	38.40	271	034584027061	24

Wholesale

Listed in numerical order

MODEL NUMBER	LIST PRICE	PAGE NO.	UNIVERSAL PRODUCT CODE	CASE QTY	MODEL NUMBER	LIST PRICE	PAGE NO.	UNIVERSAL PRODUCT CODE	CASE QTY
YB6403BL	42.35	271	034584038272	24	YB8403NL	152.15	158	034584020437	24
YB6403NL	42.35	271	034584029720	24	YB8403ORB	152.15	158	034584017956	24
YB6403ORB	42.35	271	034584027085	24	YB8403BG	165.85	158	034584028723	24
YB6408CH	63.70	271	034584027108	6	YB8405CH	22.35	158	034584021854	48
YB6408BN	70.45	271	034584027092	6	YB8405BN	25.25	158	034584021847	48
YB6408BL	77.60	271	034584038289	6	YB8405BL	27.75	158	034584029232	48
YB6408ORB	77.60	271	034584027115	6	YB8405NL	27.75	158	034584021861	48
YB6408NL	83.00	271	034584029713	6	YB8405ORB	27.75	158	034584021878	48
YB6418CH	74.05	271	034584027139	6	YB8405BG	30.30	158	034584028860	48
YB6418BN	81.30	271	034584027122	6	YB8407CH	41.75	158	034584021892	48
YB6418BL	89.50	271	034584038296	6	YB8407BN	44.60	158	034584021885	48
YB6418ORB	89.50	271	034584027146	6	YB8407BL	48.85	158	034584029249	48
YB6418NL	89.60	271	034584029706	6	YB8407NL	49.05	158	034584021908	48
YB6422CH	99.10	271	034584027160	6	YB8407ORB	49.05	158	034584021915	48
YB6422BN	106.70	271	034584027153	6	YB8407BG	53.55	158	034584028853	48
YB6422BL	117.50	271	034584038302	6	YB8408CH	174.40	158	034584017970	6
YB6422ORB	117.50	271	034584027177	6	YB8408BN	191.10	158	034584017963	6
YB6422NL	120.05	271	034584029218	6	YB8408BL	209.90	158	034584029256	6
YB6424CH	76.35	271	034584027191	6	YB8408NL	210.30	158	034584020444	6
YB6424BN	84.30	271	034584027184	6	YB8408ORB	210.30	158	034584017987	6
YB6424NL	92.45	271	034584029690	6	YB8408BG	229.40	158	034584029276	6
YB6424BL	92.70	271	034584038319	6	YB8418CH	196.85	158	034584018007	6
YB6424ORB	92.70	271	034584027207	6	YB8418BN	223.60	158	034584017994	6
YB6461CH	177.90	273	034584027344	1	YB8418BL	245.75	158	034584029263	6
YB6461BL	215.35	273	034584029317	1	YB8418NL	246.15	158	034584020451	6
YB6461NL	215.35	273	034584029324	1	YB8418ORB	246.15	158	034584018014	6
YB6461BN	222.30	273	034584027214	1	YB8418BG	268.25	158	034584028808	6
YB6461ORB	222.30	273	034584027351	1	YB8424CH	212.40	158	034584018038	6
YB6462CH	248.85	273	034584027375	1	YB8424BN	241.20	158	034584018021	6
YB6462BL	301.35	273	034584029331	1	YB8424BL	264.75	158	034584029270	6
YB6462NL	301.35	273	034584029393	1	YB8424NL	265.15	158	034584020468	6
YB6462BN	311.00	273	034584027368	1	YB8424ORB	265.15	158	034584018045	6
YB6462ORB	311.00	273	034584027382	1	YB8424BG	289.20	158	034584028785	6
YB6463CH	308.90	273	034584027443	1	YB8486CH	137.25	158	034584018069	6
YB6463BN	386.20	273	034584027399	1	YB8486BN	156.65	158	034584018052	6
YB6463NL	386.20	273	034584029379	1	YB8486BL	172.15	158	034584029287	6
YB6463ORB	386.20	273	034584027405	1	YB8486NL	172.35	158	034584020475	6
YB6463BL	402.10	273	034584029386	1	YB8486ORB	172.35	158	034584018076	6
YB6464CH	395.65	273	034584027450	1	YB8486BG	188.05	158	034584028709	6
YB6464BN	494.60	273	034584027412	1	YB8801CH	83.10	203	034584014696	24
YB6464ORB	494.60	273	034584027429	1	YB8801BN	89.70	203	034584016492	24
YB6464BL	513.60	273	034584029362	1	YB8801BL	97.75	203	034584038333	24
YB6464NL	513.60	273	034584029355	1	YB8803CH	63.65	203	034584014702	24
YB6469	32.65	273	034584027436	3	YB8803BN	68.90	203	034584016508	24
YB6486CH	52.00	271	034584027238	6	YB8803BL	75.10	203	034584038340	24
YB6486BN	56.80	271	034584027221	6	YB8805CH	16.80	203	034584018564	48
YB6486BL	62.55	271	034584038326	6	YB8805BN	19.40	203	034584018250	48
YB6486ORB	62.55	271	034584027245	6	YB8805BL	21.15	203	034584038357	48
YB6486NL	67.45	271	034584029348	6	YB8807CH	33.65	203	034584018571	48
YB8000CH	6.00	359	034584001641	50	YB8807BN	36.35	203	034584018267	48
YB8000BC	7.65	359	034584002181	50	YB8807BL	39.60	203	034584038364	48
YB8000SN	9.90	359	034584003478	50	YB8808CH	117.15	203	034584014719	6
YB8000OWB	12.85	359	034584009234	50	YB8808BN	126.40	203	034584016515	6
YB8003CH	5.25	359	034584001634	50	YB8808BL	137.80	203	034584038371	6
YB8003BC	6.70	359	034584002174	50	YB8818CH	134.80	203	034584014726	6
YB8003SN	6.85	359	034584003461	50	YB8818BN	145.55	203	034584016522	6
YB8003OWB	7.85	359	034584009241	50	YB8818BL	158.65	203	034584038388	6
YB8081	14.90	303	034584016836	25	YB8824CH	139.65	203	034584014733	6
YB8086CH	9.90	359	034584001689	50	YB8824BN	150.90	203	034584016539	6
YB8086BC	13.05	359	034584002228	50	YB8824BL	164.45	203	034584038395	6
YB8086SN	14.15	359	034584003515	50	YB8861CH	213.45	204	034584023971	2
YB8086OWB	15.15	359	034584009289	50	YB8861BN	266.70	204	034584023964	2
YB8088CH	10.85	359	034584020963	25	YB8861BL	290.70	204	034584038401	2
YB8088SN	17.70	359	034584020970	25	YB8862CH	298.60	204	034584023995	2
YB8094CH	5.00	359	034584001672	50	YB8862BN	373.35	204	034584023988	2
YB8094BC	6.45	359	034584002211	50	YB8862BL	406.95	204	034584038418	2
YB8094SN	8.20	359	034584003454	50	YB8863CH	370.85	204	034584024015	2
YB8094OWB	10.15	359	034584009272	50	YB8863BN	463.85	204	034584024008	2
YB8098CH	4.30	359	034584001665	50	YB8863BL	505.60	204	034584038425	2
YB8098BC	5.45	359	034584002204	50	YB8864CH	475.05	204	034584024039	2
YB8098SN	6.60	359	034584003492	50	YB8864BN	593.75	204	034584024022	2
YB8098OWB	7.65	359	034584009265	50	YB8864BL	647.15	204	034584038432	2
YB8099CH	2.10	359	034584001658	50	YB8869	39.20	204	034584024046	3
YB8099OWB	2.70	359	034584009258	50	YB8886CH	94.10	203	034584014740	6
YB8099SN	3.20	359	034584003485	50	YB8886BN	101.55	203	034584016546	6
YB8099BC	3.55	359	034584002198	50	YB8886BL	110.70	203	034584038449	6
YB8401CH	133.00	158	034584017918	24	YG0312CH	210.00	180	034584030511	6
YB8401BN	151.45	158	034584017901	24	YG0312BN	272.95	180	034584030504	6
YB8401BL	166.35	158	034584029300	24	YG0312NL	300.25	180	034584030528	6
YB8401NL	166.60	158	034584020420	24	YG0312BG	327.60	180	034584030498	6
YB8401ORB	166.60	158	034584017925	24	YG0318CH	219.45	180	034584030559	6
YB8401BG	181.80	158	034584028730	24	YG0318BN	285.25	180	034584030542	6
YB8403CH	120.80	158	034584017949	24	YG0318NL	313.80	180	034584030566	6
YB8403BN	138.25	158	034584017932	24	YG0318BG	342.25	180	034584030535	6
YB8403BL	151.95	158	034584029225	24	YG0324CH	229.30	180	034584030597	6

Wholesale

Listed in numerical order

SUGGESTED LIST PRICES

MODEL NUMBER	LIST PRICE	PAGE NO.	UNIVERSAL PRODUCT CODE	CASE QTY	MODEL NUMBER	LIST PRICE	PAGE NO.	UNIVERSAL PRODUCT CODE	CASE QTY
YG0324BN	297.95	180	034584030580	6	YG5412BN	162.45	523	034584483683	3
YG0324NL	327.85	180	034584030603	6	YG5412ORB	178.65	523	034584007476	3
YG0324BG	357.60	180	034584030573	6	YG5418CH	140.40	523	034584482655	3
YG0336CH	261.00	180	034584030634	6	YG5418BN	170.20	523	034584483690	3
YG0336BN	339.30	180	034584030627	6	YG5418ORB	187.45	523	034584007483	3
YG0336NL	373.20	180	034584030641	6	YG5424CH	146.60	523	034584482662	3
YG0336BG	407.15	180	034584030610	6	YG5424BN	183.75	523	034584483706	3
YG0342CH	384.05	180	034584031402	6	YG5424ORB	202.25	523	034584007490	3
YG0342BN	499.25	180	034584031396	6	YG5430CH	156.85	523	034584482679	3
YG0342NL	549.20	180	034584031419	6	YG5430BN	191.40	523	034584483713	3
YG0342BG	599.15	180	034584031389	6	YG5436CH	166.90	523	034584482686	3
YG0412CH	128.75	251	034584024091	6	YG5436BN	206.75	523	034584483720	3
YG0412BN	155.65	251	034584024107	6	YG5442CH	244.95	523	034584482693	3
YG0418CH	134.50	251	034584024114	6	YG5442BN	306.25	523	034584483737	3
YG0418BN	163.15	251	034584024121	6	YG6412CH	124.10	272	034584027269	6
YG0418BG	195.75	251	034584028693	6	YG6412BL	149.90	272	034584029942	6
YG0424CH	140.50	251	034584024138	6	YG6412BN	149.90	272	034584027252	6
YG0424BN	176.05	251	034584024145	6	YG6412NL	149.90	272	034584029447	6
YG0424BG	211.20	251	034584028686	6	YG6412ORB	164.95	272	034584027276	6
YG0436CH	159.95	251	034584024152	6	YG6418CH	129.65	272	034584027290	6
YG0436BN	198.15	251	034584024169	6	YG6418BL	156.65	272	034584029430	6
YG0442CH	234.70	251	034584024176	6	YG6418NL	156.65	272	034584029423	6
YG0442BN	293.40	251	034584024183	6	YG6418BN	157.20	272	034584027283	6
YG0712CH	84.45	341	034584021939	6	YG6418ORB	172.90	272	034584027306	6
YG0712BN	94.75	341	034584021922	6	YG6424CH	135.40	272	034584027320	6
YG0712BL	102.05	341	034584029294	6	YG6424BL	163.60	272	034584029416	6
YG0718CH	89.05	341	034584021953	6	YG6424NL	163.60	272	034584029409	6
YG0718BN	99.75	341	034584021946	6	YG6424BN	169.55	272	034584027313	6
YG0718BL	107.70	341	034584029560	6	YG6424ORB	186.60	272	034584027337	6
YG0724CH	93.65	341	034584021977	6	YG8812CH	192.55	203	034584022127	6
YG0724BN	104.80	341	034584021960	6	YG8812BN	208.10	203	034584022110	6
YG0724BL	113.20	341	034584029553	6	YG8812BL	226.85	203	034584038487	6
YG0736CH	106.65	341	034584021991	6	YG8818CH	201.20	203	034584022141	6
YG0736BN	119.40	341	034584021984	6	YG8818BN	218.10	203	034584022134	6
YG0736BL	128.90	341	034584029546	6	YG8818BL	237.75	203	034584038494	6
YG0742CH	156.75	341	034584022769	6	YG8824CH	210.20	203	034584022165	6
YG0742BN	176.75	341	034584022752	6	YG8824BN	235.40	203	034584022158	6
YG0742BL	189.40	341	034584029539	6	YG8824BL	256.55	203	034584038500	6
YG0812CH	202.20	168	034584022042	6	YG8836CH	239.25	203	034584022189	6
YG0812BL	244.20	168	034584029522	6	YG8836BN	265.05	203	034584022172	6
YG0818CH	211.25	168	034584022066	6	YG8836BL	288.90	203	034584038517	6
YG0818BL	255.20	168	034584029515	6	YG8842CH	352.20	203	034584022806	6
YG0824CH	220.75	168	034584022080	6	YG8842BN	389.35	203	034584022790	6
YG0824BL	266.65	168	034584029508	6	YG8842BL	424.40	203	034584038524	6
YG0836CH	251.25	168	034584022103	6					
YG0836BL	303.65	168	034584029492	6					
YG0842CH	351.65	168	034584022783	6					
YG0842BL	424.85	168	034584029485	6					
YG2212CH	109.65	317	034584024190	6					
YG2212BN	133.75	317	034584024206	6					
YG2212ORB	146.25	317	034584024213	6					
YG2218CH	115.90	317	034584024220	6					
YG2218BN	140.50	317	034584024237	6					
YG2218ORB	153.70	317	034584024244	6					
YG2224CH	121.40	317	034584024251	6					
YG2224BN	152.05	317	034584024268	6					
YG2224ORB	169.65	317	034584024275	6					
YG2812CH	109.65	327	034584024282	6					
YG2812BN	133.75	327	034584024299	6					
YG2812ORB	146.25	327	034584024305	6					
YG2818CH	115.90	327	034584024312	6					
YG2818BN	140.50	327	034584024329	6					
YG2818ORB	153.70	327	034584024336	6					
YG2824CH	121.40	327	034584024343	6					
YG2824BN	152.05	327	034584024350	6					
YG2824ORB	169.65	327	034584024367	6					
YG5112CH	123.55	295	034584025166	6					
YG5112BN	149.35	295	034584025241	6					
YG5112BL	164.20	295	034584038456	6					
YG5112ORB	164.20	295	034584025173	6					
YG5112NL	166.60	295	034584029478	6					
YG5112BG	179.15	295	034584028679	6					
YG5118CH	129.10	295	034584025197	6					
YG5118BN	156.60	295	034584025180	6					
YG5118BL	172.30	295	034584038463	6					
YG5118ORB	172.30	295	034584025203	6					
YG5118NL	180.50	295	034584029461	6					
YG5118BG	187.85	295	034584028662	6					
YG5124CH	134.90	295	034584025227	6					
YG5124BN	168.95	295	034584025210	6					
YG5124BL	185.90	295	034584038470	6					
YG5124ORB	185.90	295	034584025234	6					
YG5124NL	202.00	295	034584029454	6					
YG5124BG	202.65	295	034584028655	6					
YG5412CH	134.35	523	034584482648	3					

Bulk

Listed in numerical order

MODEL NUMBER	LIST PRICE	PAGE NO.	UNIVERSAL PRODUCT CODE	CASE QTY
67545C	410.25	592	026508209165	3
67315C	313.00	88	026508069257	6
67315SRS	391.30	88	026508242933	6
67840	258.00	592	026508138861	6
67425	170.20	593	026508052983	6
67430	213.95	593	026508052884	12
67434	213.95	593	026508053041	6
BGS181210B	462.95	593	026508357620	2
64601	151.80	594	026508040751	12
64621	186.55	594	026508002896	12
L64600	151.80	594	026508063705	12
L64601	151.80	594	026508063712	12
L64620	198.00	595	026508047309	12
L64621	186.55	595	026508047316	12
L64624	203.70	595	026508047347	12
L64625	188.45	595	026508047354	12
L64635	203.70	595	026508061534	12
66802	195.10	596	026508264379	6
66172	195.10	596	026508261194	6
66610	195.10	596	026508162064	6
66410	195.10	596	026508152485	6
64900	118.65	597	026508040775	12
64919	164.55	597	026508017265	12
64920	164.55	597	026508002889	12
64922	118.65	597	026508147955	12
64925	164.55	597	026508134542	12
69000	143.90	547	026508045114	6
UTL172	251.45	598	026508321171	12
UTL172EP	251.45	598	026508321188	12
UTL171	209.20	598	026508321157	12
UTL171EP	209.20	598	026508321164	12
UTL170	203.15	598	026508321140	3
T62183	116.60	600	026508264584	12
T62743	116.60	600	026508261361	6
T62153	116.60	315	026508162040	12
T62153EP	116.60	315	026508208410	12
T62133	116.60	324	026508152515	12
T62133EP	116.60	324	026508208373	12
T183	79.65	601	026508029602	12
T183EP	79.65	601	026508208809	12
TL183	79.65	352	026508047590	12
TL183EP	79.65	352	026508208519	12
TL183NH	69.95	352	026508208533	12
T62182	77.40	603	026508264577	12
T62742	77.40	603	026508261354	12
T62152	77.40	316	026508162033	12
T62152EP	77.40	316	026508208397	12
T62132	77.40	325	026508152508	12
T62132EP	77.40	325	026508208359	12
T182	49.05	604	026508029589	12
T182EP	49.05	605	026508208786	12
TL182	49.05	352	026508047552	12
TL182EP	49.05	352	026508208472	12
TL182NH	46.50	352	026508208496	12
T62151	57.60	606	026508162026	12
TL181	44.55	353	026508047620	12
T187	44.55	606	026508019832	12
T181	44.55	357	026508029565	12
T471	91.35	608	026508015742	12
T471EP	91.35	608	026508270813	12
TL471	91.35	608	026508047828	12
TL471EP	91.35	608	026508271056	12
T473	56.40	609	026508015728	12
T473EP	56.40	609	026508270967	12
TL473	56.40	609	026508047774	12
TL473EP	56.40	609	026508271087	12
T470	47.30	610	026508019825	12

MODEL NUMBER	LIST PRICE	PAGE NO.	UNIVERSAL PRODUCT CODE	CASE QTY
TL470	47.30	610	026508047842	12
62700	132.20	471	026508009277	12
62720	132.20	471	026508009284	12

B2B Connect: Best-In-Class Service

Moen® continues to empower you through B2B Connect with new technologies, responsive design, and ease of use processes to help you run your business efficiently. B2B Connect is Moen's new digital-first, self-serve business site to make it easier to do business with North America's number one faucet brand.

FEATURES:

- Check order status
- Check inventory
- Obtain order confirmation
- Order tracking details
- View and print packing slip
- Details on multi-shipment orders
- Place product orders
- Modern user interface compatible with all major web browsers
- Compatible with mobile devices
- Customer admin role to manage account users
- Product browsing and selection
- View and save shopping carts

Request an account today at B2BConnect.moen.com to receive Moen's best-in-class sales support.

Customer Support

MOEN B2B CONNECT

Phone: 1-888-450-5829 Website: B2Bconnect.moen.com Email: connect@moen.com

MOEN WHOLESALE FAUCETS

Phone: 1-800-531-1600 Fax: 1-800-848-6636 Email: moencustomerservicewholesaleUS@moen.com

MOEN RETAIL FAUCETS

Phone: 1-800-531-1606 Fax: 1-800-848-6636 Email: moencustomerserviceUS@moen.com

MOEN ACCESSORIES

Phone: 1-800-882-0116 Fax: 1-888-379-2720 Email: moencustomerserviceUS@moen.com

Visit moen.com/professional for products, tools and resources for the professional. Additional information and customer support can be found by visiting moen.com or contacting your Moen Sales Representative.

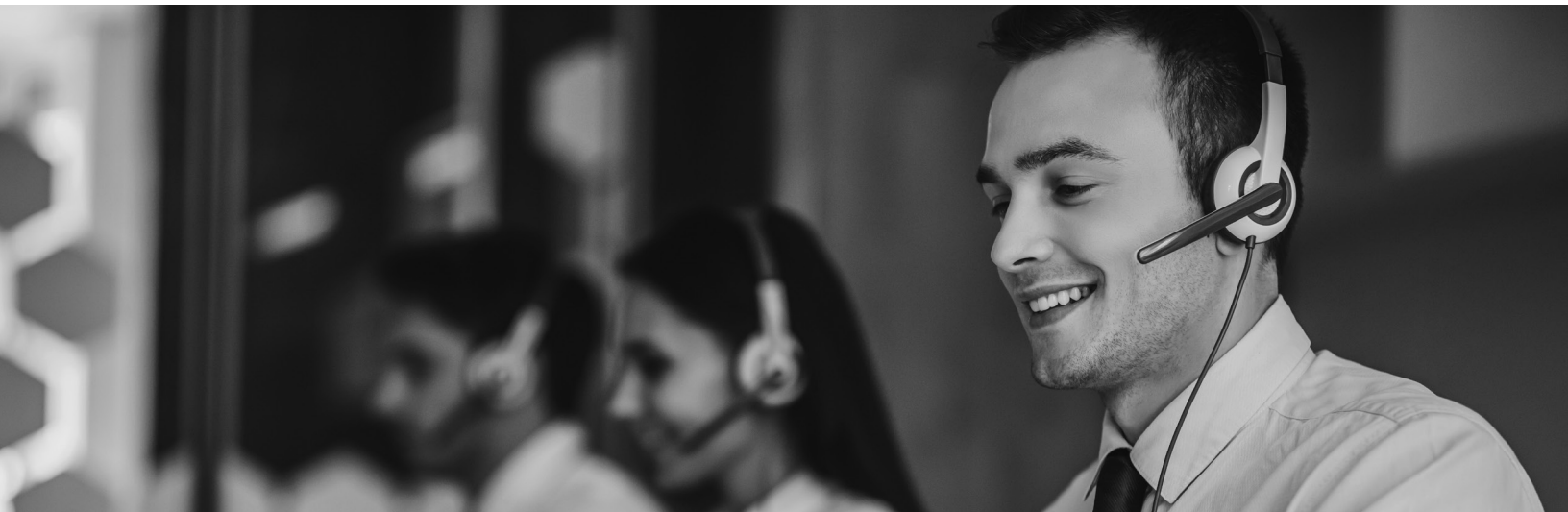

SMART WATER NETWORK



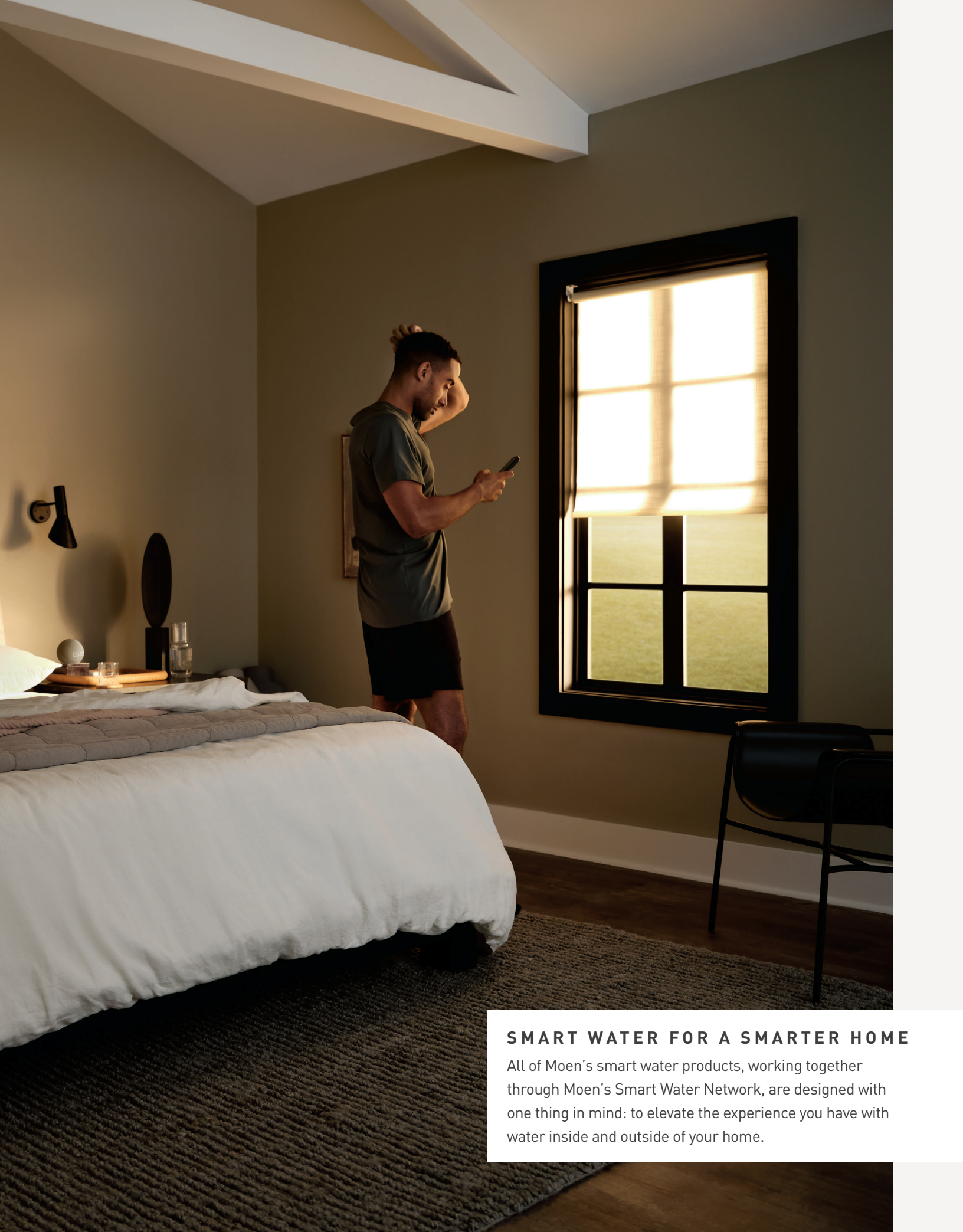

SMART WATER FOR A SMARTER HOME

All of Moen's smart water products, working together through Moen's Smart Water Network, are designed with one thing in mind: to elevate the experience you have with water inside and outside of your home.

Customized Control and Convenience

The Moen® Smart Water Network simplifies your life and gives you peace of mind by creating a deeper connection with the water in your home. Control and customize all interactions with water to elevate your experiences to a level that has never before been possible.

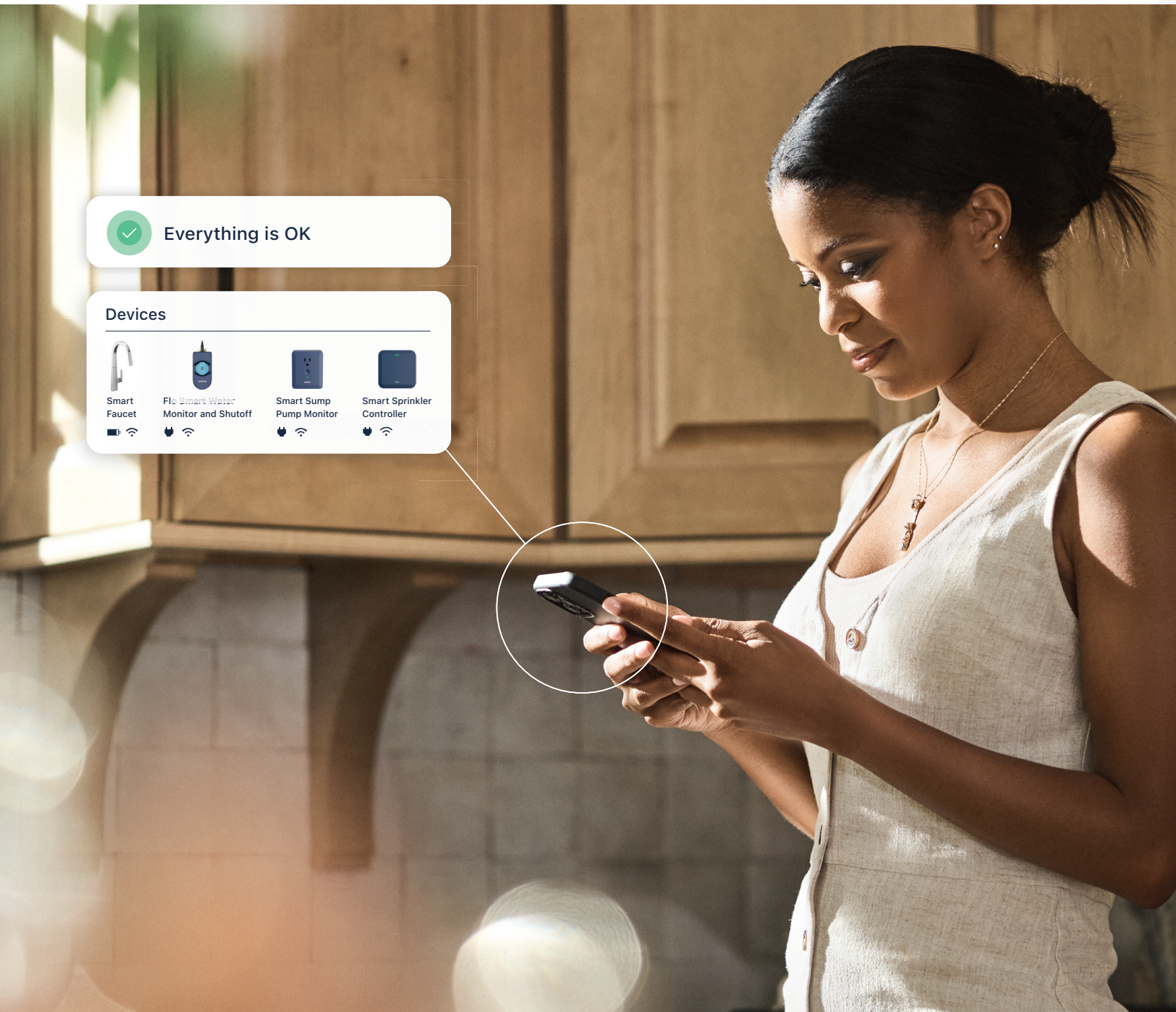



TRACK WATER USAGE

See your home's total water usage by device in the Moen® Smart Water App, so you can know when and where water is being used.

WATER SECURITY

Monitor your water usage, detect leaks in your pipes 24/7 and automatically shutoff your entire water supply before a catastrophic leak damages your home.

CUSTOMIZATION AND PERSONALIZATION

Further enhance your relationship with water throughout your home by creating preferred settings and presets for a completely personalized experience.

WHOLE HOME MONITORING

Monitor, track and control the entire water supply system throughout your home.

NOTIFICATIONS AND ALERTS

Receive real-time alerts through the app, a text or even phone call, so you can take immediate action to address potential issues.

CONSERVATION GOALS

Set and reach conservation goals with a variety of features; automatically shut off devices after a set amount of time, warmup and pause your Smart Shower until you are ready, and pour the exact amount of water you need with your Smart Faucet.

MOEN SMART WATER APP

The free iOS/Android™ Moen Smart Water app is easy to set up and allows you to control all of the features and benefits of the products in your Moen Smart Water Network from customized settings and personalized presets to monitoring water usage and automatic shutoff.



Google Play is a trademark of Google LLC. Apple® is a trademark of Apple Inc., registered in the U.S. and other countries and regions.

Smart Customizable Water

SMART PRODUCTS



NEW Q3 **Smart Handle-Free Faucet with Motion Control**



The Moen® Smart Faucet with Motion Control makes life easier and completely touch-free in the kitchen. Advanced sensor technology allows for touchless operation of both the temperature and water flow with simple hand motions, while voice-activated and app-based features offer additional control and personalization. It's an experience so seamless, you never need to touch the faucet—which is why these models have been designed without a handle entirely.

Collections

Nio™ | Apphia™

Reference Kitchen and Bar section for product details and pricing beginning on page 54



Smart Faucet with Motion Control



The Moen Smart Faucet with Motion Control makes life easier and completely touch free in the kitchen. The advanced sensor technology allows touchless operation of both the temperature and water flow by using simple hand motions, while the voice activated and app based features give you additional control and personalization.

Collections

Nio™ | Weymouth™ | Sinema™ | Paterson™

Reference Kitchen and Bar section for product details and pricing beginning on page 54



Smart Faucet



The Moen Smart Faucet makes life easier in the kitchen. Achieve precise volume and temperature control with your voice or a tap of the app; turn water on/off with the wave of your hand; or simply use the handle. Plus, with a wide range of styles and finishes, it's a beautifully practical addition to any home.

Collections

Nio | Stō™ | Weymouth | Sinema | Paterson | Cia™ | Align™
KURV™ | Brantford™ | Arbor™ | Sleek™ | Belfield™

Reference Kitchen and Bar section for product details and pricing beginning on page 54



Smart Customizable Water

SMART PRODUCTS



Smart Shower Controller and Digital Valve

The Smart Shower is a Wi-Fi enabled, digital shower that offers mobile connectivity and unmatched personalization, providing you with countless ways to create your ideal showering experience. You can control the shower in three ways: voice control through smart speakers, the U by Moen® Smart Shower App, and a shower controller. Within the app, you can create up to twelve presets including name, greeting, outlets used, temperature, timer and notifications. Additionally, the “warmup and pause” feature activates the shower to warm up to your exact temperature and then pause the water flow until you’re ready to get in, helping to reduce unnecessary water waste. With the Moen Smart Shower, your perfect shower is just a tap or voice command away.



Two-Outlet Controller
TS3302TB | TS3302BL

Four-Outlet Controller
TS3304TB | TS3304BL

Two-Outlet Valve
S3102

Four-Outlet Valve
S3104

Battery back-up sold separately | 179573

The Smart Shower controller must be paired with the Smart Shower digital valve
Controller available in Terra Beige (TB) and Matte Black (BL). See page 366 for additional product details and pricing.



Smart Water Security

SMART PRODUCTS











Flo Smart Water Monitor and Shutoff

Reduce your risk of water leaks and damage with the Flo Smart Water Monitor and Shutoff. Flo monitors flow rate and pressure of your home's water and tracks total home water usage, allowing the intelligent system to detect leaks as small as a drop a minute anywhere in your home. Plus, it can automatically shut off the water before a catastrophic leak occurs.



ELAN

	MODEL	LIST	FINISH/CONNECT	CASE QTY
FLO SMART WATER MONITOR AND SHUTOFF - PREMIUM				
 <ul style="list-style-type: none"> • Wi-Fi connected • features leak detection • features automatic shutoff • features water usage monitoring • smartphone app available for Apple iOS and Android OS • installs on main water line • AC power required 	900-001*	767.70	0.75" Shutoff	1
	900-006*	846.10	1.00" Shutoff	1
	900-002**	1230.75	1.25" Shutoff	1
FLO SMART WATER ACCESSORIES - PREMIUM				
 	920-003	18.75	25' DC Ext. Cable	10
	920-002	7.95	AC Adapter	1
FLO SMART WATER ACCESSORIES - PREMIUM				
     	930-001	62.40	0.75" NPT Spacer Kit	24
	930-002	62.40	0.75" CC Spacer Kit	24
	930-003	72.05	1.00" NPT Spacer Kit	24
	930-004	72.05	1.00" CC Spacer Kit	24
	930-005	104.85	1.25" NPT Spacer Kit	24
	930-006	104.85	1.25" CC Spacer Kit	24

* Can be installed on lines up to 1/4" | **Can be installed on lines up to 1/2"



Smart Leak Detector

The Smart Leak Detector is a standalone sensor that can be placed anywhere in a home to alert you when and where it detects moisture to help prevent water damage and loss. If the Smart Leak Detector senses the presence of water, extreme temperatures or high humidity, it will alert you in one or more ways, according to set preferences: Moen Smart Water App, text, phone call or email.



	MODEL	LIST	FINISH/CONNECT	CASE QTY
SMART LEAK DETECTOR - PREMIUM				
 <ul style="list-style-type: none"> • Wi-Fi connected • features moisture, temperature and humidity sensing • features audible, visual and app alerts • smartphone app available for Apple iOS and Android OS • installs anywhere water might be an issue • battery powered 	920-004***	78.05	Smart Leak Detector 1 pk	4
	920-005***	203.00	Smart Leak Detector 3 pk	4
	SMART LEAK DETECTOR ACCESSORY			
	920-006	35.50	6' Leak Sensing Cable	36

SMART PRODUCTS



Smart Sump Pump Monitor

Retrofittable to any sump pump (up to and including 1HP), the Moen Smart Sump Pump Monitor gives you peace of mind by monitoring your sump pump's performance through connected, smart technology that provides 24/7 alerts of potential failure or flooding issues, before it's too late.



	MODEL	LIST	FINISH/CONNECT	CASE QTY
SMART SUMP PUMP MONITOR - PREMIUM				
 <ul style="list-style-type: none"> • Wi-Fi connected • features ability to monitor and alert of potential issues with a sump pump system • features moisture, temperature and humidity sensing • smartphone app available for Apple iOS and Android OS • retrofits to any brand sump pump up to 1 HP • plugs into standard outlet and primary sump pump plugs into monitor • comes with 10' smart water level sensor, 6' leak sensing disc, 9 volt battery back-up and zip ties for installation 	S2000ESUSA	261.90	N/A	2

Requires:

- standard electrical outlet with 8 ft. of sump pump basin lid. For longer distances, a 5 ft. smart water level sensor extension cable is available
- Wi-Fi 2.4 Ghz
- iOS or Android Smart phone
- Moen Smart Water App

***Comes with 48" detector extension cable for hard to reach areas

Smart Irrigation NEW

SMART PRODUCTS





Smart Sprinkler Controller

The Moen® Smart Sprinkler Controller offers simple, intelligent and affordable control over home irrigation systems—all accessible from the Moen Smart Water App. Eliminate the guesswork in managing sprinkler routines with the controller's unique features that automate watering and ensure lawns and landscapes get water where it's needed, only when it's needed—helping to reduce water waste.



	MODEL	LIST	FINISH/CONNECT	CASE QTY
SMART SPRINKLER CONTROLLER - PREMIUM				
<ul style="list-style-type: none"> • Wi-Fi connected • retrofits on existing installed irrigation system • app control enables independent zone control, ability to set schedules, weather skip and seasonal adjustments • available in 8 or 16 zone controllers 	WICNT008G1USA	270.00	8-Zone Controller	1
	WICNT016G1USA	352.50	16-Zone Controller	1

SMART PRODUCTS



Smart Wireless Soil Sensor

Moen Smart Wireless Soil Sensors pair with the Moen Smart Sprinkler Controller to intelligently optimize and automate inground home irrigation systems. By monitoring the moisture and temperature levels of the soil, the sensors ensure just the right amount of water is used—where and when it's needed most—to ensure a healthy and lush landscape. Just set and forget.

	MODEL	LIST	FINISH/CONNECT	CASE QTY
SMART WIRELESS SOIL SENSOR - PREMIUM				
<ul style="list-style-type: none"> • wireless connection directly to Moen Smart Sprinkler Controller to automatically adjust watering schedule based on exact soil moisture • measure soil moisture and temperature levels at 1, 3 and 5-inch depths • recommend one sensor per zone 	WISNS002G1USA	105.00	Wireless Soil Sensor - 1 Pk	3



Smart Sprinkler Controller Outdoor Enclosure

The Moen Smart Sprinkler Controller Outdoor Enclosure securely houses the Moen Smart Sprinkler Controller to protect the device in outdoor installation settings. The water-tight enclosure is made of high-grade plastic and is certified for outdoor electrical systems to ensure it can withstand outdoor weather conditions and keep your controller protected and running uninterrupted.

	MODEL	LIST	FINISH/CONNECT	CASE QTY
SMART SPRINKLER CONTROLLER OUTDOOR ENCLOSURE - PREMIUM				
<ul style="list-style-type: none"> • enables Moen Smart Sprinkler Controller to be installed outdoors • fits 8 or 16 zone Smart Sprinkler Controllers 	WIACC001G1USA	60.00	Outdoor Enclosure	12

KITCHEN AND BAR





CIA™ KITCHEN COLLECTION

The Cia kitchen faucet stands out with its elegant, C-shaped spout. The new spring design features Power Boost™ Pro spray technology for enhanced cleaning ability and targeted control. The choice of three other platforms and several on-trend finishes and included contrasting finish escutcheons allow you to customize the faucet's style and functionality so it's just right for your lifestyle.

Cia One-Handle Pre-Rinse Spring Power Boost Pro Pulldown Kitchen Faucet | 7822BL



Create the ultimate beverage station by including a bar faucet in your kitchen layout.



Kitchen and Bar

COLLECTIONS

- 59 Smart Faucets
- 70 Premium Faucets
- 77 Faucets
- 91 Premium Pot Fillers
- 92 Premium Bar/Prep
- 94 Bar/Prep
- 97 Laundry Faucets
- 99 Water Filtration Systems & Faucets
- 106 Premium Soap/Lotion Dispensers

FINISHES

- Chrome
- Spot Resist Stainless
- Matte Black
- Matte Black/Chrome
- Polished Nickel
- Oil Rubbed Bronze
- Black Stainless
- Brushed Gold

LifeShine® Non-Tarnish Finish

All Brushed Gold and Polished Nickel faucet components feature the LifeShine Non-Tarnish Finish.

Want to add Water Filtration or a Soap Dispenser in the Kitchen?
See pages 99-107.

Bar/Prep faucet available.
See pages 92-96.

Deck Extension kits available on page 547.

ICON KEY



MotionSense Wave™ Hands-Free Faucet
MotionSense Wave single-sensor faucets allow you to easily turn water on and off with the wave of a hand.



Offers 3 times more reach when compared to most residential pre-rinse spring faucets.



Spot Resist™ Stainless

Spot Resist Stainless finish resists fingerprints and water spots for a cleaner looking kitchen.

DURALOCK®

Push-button connector that makes installing faucets quick, secure and hassle-free – no tools required. A telltale 'click' audibly signals a secure connection.

DURALAST®

Duralast Cartridge

Provides the smooth feel and reliable operation of a new faucet from the first time you use it to the last.

reflex

Secure retraction, range of motion, and flexibility. Works in unison as a complete system of innovations.

POWERBOOST™

Boosted stream fills pots and pitchers faster, while the boosted spray cleans 50 percent faster than other Moen faucets without Power Clean™ or Power Boost™ technology.

POWER CLEAN™

Cleans 50 percent faster than most Moen pulldowns and pullout faucets without Power Clean™ or Power Boost™ technology while containing splash and minimizing mess.



PowerBoost™ Pro

Faucets with Power Boost Pro offer a variable flow rate from 1.1-2.2 GPM to meet any need for improved cleaning spray, reduced splash and the ability to save water with a low-flow stream that won't sacrifice experience.



Also available in bulk pack.
See page 589.



KITCHEN TOUCHLESS FAUCETS



Smart Faucet with Motion Control

- Nio™
- Apphia™ **NEW!**
- Weymouth®
- Sinema™
- Paterson™

Smart Faucet

- Nio™
- STo®
- Weymouth®
- Sinema™
- Paterson™
- Cia™
- Align®
- KURV™
- Brantford®
- Arbor®
- Belfield™
- Sleek®

MotionSense Wave™

- Cia™
- Align®
- KURV™
- Brantford®
- Arbor®
- Belfield™
- Genta™ LX
- Sleek®

Touchless Kitchen Faucets





For the busiest room in your home, select Moen faucets use touchless technology and voice control to make life easier in the kitchen. If your hands are occupied or messy, or you're concerned about the spread of germs, you'll love our touchless features.

The Smart Faucet with Motion Control is the only faucet you never have to touch, offering advanced sensor technology that allows you to control the temperature of water with a simple hand motion, as well as voice control.

The Smart Faucet makes every day easier by allowing you to precisely control with your voice or a wave of your hand the amount of water you use.

MotionSense Wave™ allows you to turn water on and off with just the wave of a hand with no need to touch the faucet handle to start the flow. The faucet also offers manual operation as an optional choice.







	MODEL	LIST	FINISH/CONNECT	CASE QTY
NIO™	SMART FAUCET WITH MOTION CONTROL HANDLE-FREE KITCHEN PULLDOWN - PREMIUM			
 <p>NEW! Q3</p> <ul style="list-style-type: none"> • application: one hole • spout height: 18.38" • connection: 3/8" compression • number of functions: four-function • spray type: aerated stream; powerful cleaning rinse; boosted rinse; boosted stream • hose length: 68" • AC adapter included • DC powered: 6 D-cell batteries included • voice activated kitchen: compatible with Amazon Just Ask Alexa and Works with Google Assistant 	1.5 GPM (5.7 L/min) max.			
	S70005EV2C	1213.05	Chrome	3
	S70005EV2SRS●	1334.35	Spot Resist Stainless	3
	S70005EV2BL	1395.05	Matte Black	3
	S70005EV2BLS	1455.70	Black Stainless	3
	OPTIONAL WALL MOUNT & HOSE EXTENSION KIT SOLD SEPARATELY			
	199785	58.60	N/A or Unfinished	6
 POWERBOOST  reflex  DURALOCK®  DURALAST®				





TOUCHLESS Kitchen Faucets

TOUCHLESS KITCHEN



	MODEL	LIST	FINISH/CONNECT	CASE QTY
APPHIA™ SMART FAUCET WITH MOTION CONTROL HANDLE-FREE KITCHEN PULLDOWN - PREMIUM				
 <p>NEW! Q3</p> <ul style="list-style-type: none"> • spray wand: metal • application: one hole • spout height: 21.75" • connection: 3/8" compression • number of functions: four-function • spray type: aerated stream; powerful cleaning rinse; boosted rinse; boosted stream • handle mounting: right only • hose length: 68" • DC powered: 6 AA cell batteries included 	1.5 GPM (5.7 L/min) max.			
	S70909EV2CH	1276.90	Chrome	3
	S70909EV2SRS●	1404.60	Spot Resist Stainless	3
	S70909EV2BL	1468.45	Matte Black	3
	S70909EV2NL	1532.30	Polished Nickel	3
	S70909EV2BG	1532.30	Brushed Gold	3
	OPTIONAL WALL MOUNT & HOSE EXTENSION KIT SOLD SEPARATELY			
199785	58.60	N/A or Unfinished	6	
				





	MODEL	LIST	FINISH/CONNECT	CASE QTY
NIO™ SMART FAUCET WITH MOTION CONTROL ONE-HANDLE KITCHEN PULLDOWN - PREMIUM				
 <ul style="list-style-type: none"> • application: one hole • spout height: 18.38" • connection: 3/8" compression • number of functions: four-function • spray type: aerated stream; powerful cleaning rinse; boosted rinse; boosted stream • handle mounting: right only • hose length: 68" • secondary two-tone handle option included: chrome faucet has matte black handle; matte black faucet has brushed gold handle; spot resist faucet has matte black handle; black stainless faucet has spot resist stainless handle • AC adapter included • DC powered: 6 D-cell batteries included • voice activated kitchen: compatible with Amazon Just Ask Alexa and Works with Google Assistant 	1.5 GPM (5.7 L/min) max.			
	S75005EV2C	1160.85	Chrome	3
	S75005EV2SRS●	1276.95	Spot Resist Stainless	3
	S75005EV2BL	1335.00	Matte Black	3
	S75005EV2BLS●	1393.00	Black Stainless	3
	OPTIONAL WALL MOUNT & HOSE EXTENSION KIT SOLD SEPARATELY			
	199785	58.60	N/A or Unfinished	6
				

	MODEL	LIST	FINISH/CONNECT	CASE QTY
WEYMOUTH® SMART FAUCET WITH MOTION CONTROL ONE-HANDLE KITCHEN PULLDOWN - PREMIUM				
 <ul style="list-style-type: none"> • spray wand: metal • application: one hole • spout height: 17.00" • connection: 3/8" compression • number of functions: four-function • spray type: aerated stream; powerful cleaning rinse; boosted rinse; boosted stream • handle mounting: right only • hose length: 68" • includes: choice of matching finish or porcelain handle caps • AC adapter included • DC powered: 6 D-cell batteries included • voice activated kitchen: compatible with Amazon Just Ask Alexa and Works with Google Assistant 	1.5 GPM (5.7 L/min) max.			
	S73004EV2C	1042.25	Chrome	3
	S73004EV2SRS●	1146.50	Spot Resist Stainless	3
	S73004EV2BL	1198.60	Matte Black	3
	S73004EV2NL	1250.70	Polished Nickel	3
	S73004EV2ORB	1250.70	Oil Rubbed Bronze	3
	S73004EV2BG	1250.70	Brushed Gold	3
OPTIONAL WALL MOUNT & HOSE EXTENSION KIT SOLD SEPARATELY				
199785	58.60	N/A or Unfinished	6	
				



TOUCHLESS Kitchen Faucets

	MODEL	LIST	FINISH/CONNECT	CASE QTY
SINEMA™ SMART FAUCET WITH MOTION CONTROL ONE-HANDLE KITCHEN PULLDOWN - PREMIUM				
 	<ul style="list-style-type: none"> • spray wand: metal • application: one hole • spout height: 17.75" • connection: 3/8" compression • number of functions: four-function • spray type: aerated stream; powerful cleaning rinse; boosted rinse; boosted stream • handle mounting: right only • hose length: 68" • two-tone art deco-inspired etched handle installed on faucet; secondary matching finish handle option included • AC adapter included • DC powered: 6 D-cell batteries included • voice activated kitchen: compatible with Amazon Just Ask Alexa and Works with Google Assistant 			
	1.5 GPM (5.7 L/min) max.			
	S7235EV2C	1174.75	Chrome	3
	S7235EV2SRS●	1292.20	Spot Resist Stainless	3
	S7235EV2BL	1350.95	Matte Black	3
S7235EV2NL	1409.70	Polished Nickel	3	
OPTIONAL WALL MOUNT & HOSE EXTENSION KIT SOLD SEPARATELY				
199785	58.60	N/A or Unfinished	6	
 POWERBOOST reflex  DURALOCK® DURALAST®				

	MODEL	LIST	FINISH/CONNECT	CASE QTY
PATERSON™ SMART FAUCET WITH MOTION CONTROL ONE-HANDLE KITCHEN PULLDOWN - PREMIUM				
 	<ul style="list-style-type: none"> • application: one hole • spout height: 17.00" • connection: 3/8" compression • number of functions: four-function • spray type: aerated stream; powerful cleaning rinse; boosted rinse; boosted stream • handle mounting: right only • secondary wheel handle option: included • hose length: 68" • AC adapter included • DC powered: 6 D-cell batteries included • voice activated kitchen: compatible with Amazon Just Ask Alexa and Works with Google Assistant 			
	1.5 GPM (5.7 L/min) max.			
	S72003EV2C	1021.30	Chrome	3
	S72003EV2SRS●	1123.40	Spot Resist Stainless	3
	S72003EV2BL	1174.45	Matte Black	3
OPTIONAL WALL MOUNT & HOSE EXTENSION KIT SOLD SEPARATELY				
199785	58.60	N/A or Unfinished	6	
 POWERBOOST reflex  DURALOCK® DURALAST®				

	MODEL	LIST	FINISH/CONNECT	CASE QTY
NIO™ SMART FAUCET ONE-HANDLE KITCHEN PULLDOWN - PREMIUM				
 	<ul style="list-style-type: none"> • application: one hole • spout height: 18.38" • connection: 3/8" compression • number of functions: four-function • spray type: aerated stream; powerful cleaning rinse; boosted rinse; boosted stream • handle mounting: right only • hose length: 68" • secondary two-tone handle option included: chrome faucet has matte black handle; matte black faucet has brushed gold handle; spot resist faucet has matte black handle; black stainless faucet has spot resist stainless handle • DC powered: 6 D-cell batteries included • voice activated kitchen: compatible with Amazon Just Ask Alexa and Works with Google Assistant 			
	1.5 GPM (5.7 L/min) max.			
	S75005EVC	1152.25	Chrome	3
	S75005EVSRS●	1267.45	Spot Resist Stainless	3
	S75005EVBL	1325.05	Matte Black	3
S75005EVBLS●	1382.70	Black Stainless	3	
OPTIONAL AC ADAPTERS SOLD SEPARATELY				
169031	156.45	N/A or Unfinished	12	
OPTIONAL WALL MOUNT & HOSE EXTENSION KIT SOLD SEPARATELY				
199785	58.60	N/A or Unfinished	6	
 POWERBOOST reflex  DURALOCK® DURALAST®				





TOUCHLESS Kitchen Faucets

TOUCHLESS KITCHEN

	MODEL	LIST	FINISH/CONNECT	CASE QTY
	SMART FAUCET ONE-HANDLE KITCHEN PULLDOWN - PREMIUM			
	<ul style="list-style-type: none"> • application: one hole • spout height: 17.25" • connection: 3/8" compression • number of functions: four-function • powerboost wand concealed in spout • spray type: aerated stream; powerful cleaning rinse; boosted rinse; boosted stream • handle mounting: right only • hose length: 68" • DC powered: 6 D-cell batteries included • voice activated kitchen: compatible with Amazon Just Ask Alexa and Works with Google Assistant 			
	1.5 GPM (5.7 L/min) max.			
	S72308EVC	1151.10	Chrome	3
	S72308EVSRS●	1266.20	Spot Resist Stainless	3
	S72308EVBL	1323.75	Matte Black	3
	S72308EVBG	1381.30	Brushed Gold	3
	OPTIONAL AC ADAPTERS SOLD SEPARATELY			
	169031	156.45	N/A or Unfinished	12
	OPTIONAL WALL MOUNT & HOSE EXTENSION KIT SOLD SEPARATELY			
199785	58.60	N/A or Unfinished	6	



 **POWERBOOST** reflex  **DURALOCK® DURALAST®**

	MODEL	LIST	FINISH/CONNECT	CASE QTY
 	SMART FAUCET ONE-HANDLE KITCHEN PULLDOWN - PREMIUM			
	<ul style="list-style-type: none"> • spray wand: metal • application: one hole • spout height: 17.00" • connection: 3/8" compression • number of functions: four-function • spray type: aerated stream; powerful cleaning rinse; boosted rinse; boosted stream • handle mounting: right only • hose length: 68" • includes: choice of matching finish or porcelain handle caps • DC powered: 6 D-cell batteries included • voice activated kitchen: compatible with Amazon Just Ask Alexa and Works with Google Assistant 			
	1.5 GPM (5.7 L/min) max.			
	S73004EVC	1031.95	Chrome	3
	S73004EVSRS●	1135.15	Spot Resist Stainless	3
	S73004EVBL	1186.75	Matte Black	3
	S73004EVNL	1238.35	Polished Nickel	3
	S73004EVORB	1238.35	Oil Rubbed Bronze	3
	S73004EVBG	1238.35	Brushed Gold	3
	OPTIONAL AC ADAPTERS SOLD SEPARATELY			
169031	156.45	N/A or Unfinished	12	
OPTIONAL WALL MOUNT & HOSE EXTENSION KIT SOLD SEPARATELY				
199785	58.60	N/A or Unfinished	6	

 **POWERBOOST** reflex  **DURALOCK® DURALAST®**

	MODEL	LIST	FINISH/CONNECT	CASE QTY
 	SMART FAUCET ONE-HANDLE KITCHEN PULLDOWN - PREMIUM			
	<ul style="list-style-type: none"> • spray wand: metal • application: one hole • spout height: 17.75" • connection: 3/8" compression • number of functions: four-function • spray type: aerated stream; powerful cleaning rinse; boosted rinse; boosted stream • handle mounting: right only • hose length: 68" • two-tone art deco-inspired etched handle installed on faucet; secondary matching finish handle option included • DC powered: 6 D-cell batteries included • voice activated kitchen: compatible with Amazon Just Ask Alexa and Works with Google Assistant 			
	1.5 GPM (5.7 L/min) max.			
	S7235EVC	1004.15	Chrome	3
	S7235EVSRS●	1104.60	Spot Resist Stainless	3
	S7235EVBL	1154.80	Matte Black	3
	S7235EVNL	1205.00	Polished Nickel	3
	OPTIONAL AC ADAPTERS SOLD SEPARATELY			
	169031	156.45	N/A or Unfinished	12
	OPTIONAL WALL MOUNT & HOSE EXTENSION KIT SOLD SEPARATELY			
199785	58.60	N/A or Unfinished	6	



 **POWERBOOST** reflex  **DURALOCK® DURALAST®**



	MODEL	LIST	FINISH/CONNECT	CASE QTY
 	SMART FAUCET ONE-HANDLE KITCHEN PULLDOWN - PREMIUM			
	<ul style="list-style-type: none"> • spray wand: metal • application: one hole • spout height: 17.00" • connection: 3/8" compression • number of functions: four-function • spray type: aerated stream; powerful cleaning rinse; boosted rinse; boosted stream • handle mounting: right only • hose length: 68" • secondary wheel handle option: included • DC powered: 6 D-cell batteries included • voice activated kitchen: compatible with Amazon Just Ask Alexa and Works with Google Assistant 			
	1.5 GPM (5.7 L/min) max.			
	S72003EVC	1011.20	Chrome	3
	S72003EVSRS●	1112.30	Spot Resist Stainless	3
	S72003EVBL	1162.85	Matte Black	3
	OPTIONAL AC ADAPTERS SOLD SEPARATELY			
	169031	156.45	N/A or Unfinished	12
	OPTIONAL WALL MOUNT & HOSE EXTENSION KIT SOLD SEPARATELY			
	199785	58.60	N/A or Unfinished	6



 **POWERBOOST** reflex  **DURALOCK® DURALAST®**



TOUCHLESS Kitchen Faucets

	MODEL	LIST	FINISH/CONNECT	CASE QTY																																							
CIATM SMART FAUCET ONE-HANDLE KITCHEN PULLDOWN																																											
 <p>DECKPLATE SOLD SEPARATELY</p> 	<ul style="list-style-type: none"> • application: one or three hole • spout height: 16.86" • connection: 3/8" compression • number of functions: four-function • spray type: aerated stream; powerful cleaning rinse; boosted rinse; boosted stream • handle mounting: right only • hose length: 68" • secondary accent escutcheon option included: chrome faucet has optional matte black; spot resist stainless has chrome; matte black has brushed gold and chrome; brushed gold has matte black • DC powered: 6 D-cell batteries included • voice activated kitchen: compatible with Amazon Just Ask Alexa and Works with Google Assistant 																																										
	<p>1.5 GPM (5.7 L/min) max.</p> <table border="1"> <tr> <td>7622EVC</td> <td>913.65</td> <td>Chrome</td> <td>3</td> </tr> <tr> <td>7622EVSRS●</td> <td>1005.00</td> <td>Spot Resist Stainless</td> <td>3</td> </tr> <tr> <td>7622EVBL</td> <td>1050.70</td> <td>Matte Black</td> <td>3</td> </tr> <tr> <td>7622EVBG</td> <td>1096.35</td> <td>Brushed Gold</td> <td>3</td> </tr> </table> <p>OPTIONAL DECKPLATE SOLD SEPARATELY</p> <table border="1"> <tr> <td>141002</td> <td>56.60</td> <td>Chrome</td> <td>6</td> </tr> <tr> <td>141002SRS●</td> <td>64.95</td> <td>Spot Resist Stainless</td> <td>6</td> </tr> <tr> <td>141002BL</td> <td>64.95</td> <td>Matte Black</td> <td>6</td> </tr> <tr> <td>141002BG</td> <td>64.95</td> <td>Brushed Gold</td> <td>6</td> </tr> </table> <p>OPTIONAL AC ADAPTERS SOLD SEPARATELY</p> <table border="1"> <tr> <td>169031</td> <td>156.45</td> <td>N/A or Unfinished</td> <td>12</td> </tr> </table> <p>OPTIONAL WALL MOUNT & HOSE EXTENSION KIT SOLD SEPARATELY</p> <table border="1"> <tr> <td>199785</td> <td>58.60</td> <td>N/A or Unfinished</td> <td>6</td> </tr> </table>				7622EVC	913.65	Chrome	3	7622EVSRS●	1005.00	Spot Resist Stainless	3	7622EVBL	1050.70	Matte Black	3	7622EVBG	1096.35	Brushed Gold	3	141002	56.60	Chrome	6	141002SRS●	64.95	Spot Resist Stainless	6	141002BL	64.95	Matte Black	6	141002BG	64.95	Brushed Gold	6	169031	156.45	N/A or Unfinished	12	199785	58.60	N/A or Unfinished
7622EVC	913.65	Chrome	3																																								
7622EVSRS●	1005.00	Spot Resist Stainless	3																																								
7622EVBL	1050.70	Matte Black	3																																								
7622EVBG	1096.35	Brushed Gold	3																																								
141002	56.60	Chrome	6																																								
141002SRS●	64.95	Spot Resist Stainless	6																																								
141002BL	64.95	Matte Black	6																																								
141002BG	64.95	Brushed Gold	6																																								
169031	156.45	N/A or Unfinished	12																																								
199785	58.60	N/A or Unfinished	6																																								
<p> POWERBOOST reflex DURALOCK® DURALAST®</p>																																											



	MODEL	LIST	FINISH/CONNECT	CASE QTY																																															
ALIGN® SMART FAUCET ONE-HANDLE KITCHEN PULLDOWN																																																			
 <p>DECKPLATE SOLD SEPARATELY</p> 	<ul style="list-style-type: none"> • application: one or three hole • spout height: 15.70" • connection: 3/8" compression • number of functions: four-function • spray type: aerated stream; powerful cleaning rinse; boosted rinse; boosted stream • handle mounting: right only • hose length: 68" • DC powered: 6 D-cell batteries included • voice activated kitchen: compatible with Amazon Just Ask Alexa and Works with Google Assistant 																																																		
	<p>1.5 GPM (5.7 L/min) max.</p> <table border="1"> <tr> <td>7565EVC</td> <td>889.60</td> <td>Chrome</td> <td>3</td> </tr> <tr> <td>7565EVSRS●</td> <td>978.55</td> <td>Spot Resist Stainless</td> <td>3</td> </tr> <tr> <td>7565EVBL</td> <td>1023.05</td> <td>Matte Black</td> <td>3</td> </tr> <tr> <td>7565EVBS●</td> <td>1067.50</td> <td>Black Stainless</td> <td>3</td> </tr> <tr> <td>7565EVBG</td> <td>1067.50</td> <td>Brushed Gold</td> <td>3</td> </tr> </table> <p>OPTIONAL DECKPLATE SOLD SEPARATELY</p> <table border="1"> <tr> <td>141002</td> <td>56.60</td> <td>Chrome</td> <td>6</td> </tr> <tr> <td>141002SRS●</td> <td>64.95</td> <td>Spot Resist Stainless</td> <td>6</td> </tr> <tr> <td>141002BL</td> <td>64.95</td> <td>Matte Black</td> <td>6</td> </tr> <tr> <td>141002BLS●</td> <td>71.45</td> <td>Black Stainless</td> <td>6</td> </tr> <tr> <td>141002BG</td> <td>64.95</td> <td>Brushed Gold</td> <td>6</td> </tr> </table> <p>OPTIONAL AC ADAPTERS SOLD SEPARATELY</p> <table border="1"> <tr> <td>169031</td> <td>156.45</td> <td>N/A or Unfinished</td> <td>12</td> </tr> </table> <p>OPTIONAL WALL MOUNT & HOSE EXTENSION KIT SOLD SEPARATELY</p> <table border="1"> <tr> <td>199785</td> <td>58.60</td> <td>N/A or Unfinished</td> <td>6</td> </tr> </table>				7565EVC	889.60	Chrome	3	7565EVSRS●	978.55	Spot Resist Stainless	3	7565EVBL	1023.05	Matte Black	3	7565EVBS●	1067.50	Black Stainless	3	7565EVBG	1067.50	Brushed Gold	3	141002	56.60	Chrome	6	141002SRS●	64.95	Spot Resist Stainless	6	141002BL	64.95	Matte Black	6	141002BLS●	71.45	Black Stainless	6	141002BG	64.95	Brushed Gold	6	169031	156.45	N/A or Unfinished	12	199785	58.60	N/A or Unfinished
7565EVC	889.60	Chrome	3																																																
7565EVSRS●	978.55	Spot Resist Stainless	3																																																
7565EVBL	1023.05	Matte Black	3																																																
7565EVBS●	1067.50	Black Stainless	3																																																
7565EVBG	1067.50	Brushed Gold	3																																																
141002	56.60	Chrome	6																																																
141002SRS●	64.95	Spot Resist Stainless	6																																																
141002BL	64.95	Matte Black	6																																																
141002BLS●	71.45	Black Stainless	6																																																
141002BG	64.95	Brushed Gold	6																																																
169031	156.45	N/A or Unfinished	12																																																
199785	58.60	N/A or Unfinished	6																																																
<p> POWERBOOST reflex DURALOCK® DURALAST®</p>																																																			



	MODEL	LIST	FINISH/CONNECT	CASE QTY																																							
KURV™ SMART FAUCET ONE-HANDLE KITCHEN PULLDOWN																																											
 <p>DECKPLATE SOLD SEPARATELY</p> 	<ul style="list-style-type: none"> • spray wand: metal • application: one or three hole • spout height: 16.38" • connection: 3/8" compression • number of functions: four-function • spray type: aerated stream; powerful cleaning rinse; boosted rinse; boosted stream • handle mounting: right only • hose length: 68" • DC powered: 6 D-cell batteries included • voice activated kitchen: compatible with Amazon Just Ask Alexa and Works with Google Assistant 																																										
	<p>1.5 GPM (5.7 L/min) max.</p> <table border="1"> <tr> <td>9126EVC</td> <td>871.40</td> <td>Chrome</td> <td>3</td> </tr> <tr> <td>9126EVSRS●</td> <td>958.55</td> <td>Spot Resist Stainless</td> <td>3</td> </tr> <tr> <td>9126EVBL</td> <td>1002.10</td> <td>Matte Black</td> <td>3</td> </tr> <tr> <td>9126EVNL</td> <td>1045.65</td> <td>Polished Nickel</td> <td>3</td> </tr> </table> <p>OPTIONAL DECKPLATE SOLD SEPARATELY</p> <table border="1"> <tr> <td>141002</td> <td>56.60</td> <td>Chrome</td> <td>6</td> </tr> <tr> <td>141002SRS●</td> <td>64.95</td> <td>Spot Resist Stainless</td> <td>6</td> </tr> <tr> <td>141002BL</td> <td>64.95</td> <td>Matte Black</td> <td>6</td> </tr> <tr> <td>141002NL</td> <td>61.60</td> <td>Polished Nickel</td> <td>6</td> </tr> </table> <p>OPTIONAL AC ADAPTERS SOLD SEPARATELY</p> <table border="1"> <tr> <td>169031</td> <td>156.45</td> <td>N/A or Unfinished</td> <td>12</td> </tr> </table> <p>OPTIONAL WALL MOUNT & HOSE EXTENSION KIT SOLD SEPARATELY</p> <table border="1"> <tr> <td>199785</td> <td>58.60</td> <td>N/A or Unfinished</td> <td>6</td> </tr> </table>				9126EVC	871.40	Chrome	3	9126EVSRS●	958.55	Spot Resist Stainless	3	9126EVBL	1002.10	Matte Black	3	9126EVNL	1045.65	Polished Nickel	3	141002	56.60	Chrome	6	141002SRS●	64.95	Spot Resist Stainless	6	141002BL	64.95	Matte Black	6	141002NL	61.60	Polished Nickel	6	169031	156.45	N/A or Unfinished	12	199785	58.60	N/A or Unfinished
9126EVC	871.40	Chrome	3																																								
9126EVSRS●	958.55	Spot Resist Stainless	3																																								
9126EVBL	1002.10	Matte Black	3																																								
9126EVNL	1045.65	Polished Nickel	3																																								
141002	56.60	Chrome	6																																								
141002SRS●	64.95	Spot Resist Stainless	6																																								
141002BL	64.95	Matte Black	6																																								
141002NL	61.60	Polished Nickel	6																																								
169031	156.45	N/A or Unfinished	12																																								
199785	58.60	N/A or Unfinished	6																																								
<p> POWERBOOST reflex DURALOCK® DURALAST®</p>																																											









TOUCHLESS Kitchen Faucets

TOUCHLESS KITCHEN

		MODEL	LIST	FINISH/CONNECT	CASE QTY	
BRANTFORD®		SMART FAUCET ONE-HANDLE KITCHEN PULLDOWN				
 <p>DECKPLATE INCLUDED</p> 	<ul style="list-style-type: none"> • application: one or three hole • spout height: 15.50" • connection: 3/4" compression • number of functions: four-function • spray type: aerated stream; powerful cleaning rinse; boosted rinse; boosted stream • handle mounting: right only • hose length: 68" • deckplate: included • DC powered: 6 D-cell batteries included • voice activated kitchen: compatible with Amazon Just Ask Alexa and Works with Google Assistant 	1.5 GPM (5.7 L/min) max.				
	7185EVC	811.10	Chrome	3		
	7185EVSRS●	892.20	Spot Resist Stainless	3		
	7185EVORB	973.35	Oil Rubbed Bronze	3		
	OPTIONAL AC ADAPTERS SOLD SEPARATELY					
	169031	156.45	N/A or Unfinished	12		
	OPTIONAL WALL MOUNT & HOSE EXTENSION KIT SOLD SEPARATELY					
	199785	58.60	N/A or Unfinished	6		
	 POWERBOOST reflex DURALOCK® DURALAST®					





ARBOR®		SMART FAUCET ONE-HANDLE KITCHEN PULLDOWN			
 <p>DECKPLATE INCLUDED</p> 	<ul style="list-style-type: none"> • application: one or three hole • spout height: 15.50" • connection: 3/8" compression • number of functions: four-function • spray type: aerated stream; powerful cleaning rinse; boosted rinse; boosted stream • handle mounting: right only • hose length: 68" • deckplate: included • DC powered: 6 D-cell batteries included • voice activated kitchen: compatible with Amazon Just Ask Alexa and Works with Google Assistant 	1.5 GPM (5.7 L/min) max.			
	7594EVC	788.60	Chrome	3	
	7594EVSRS●	867.45	Spot Resist Stainless	3	
	7594EVBL	906.90	Matte Black	3	
	7594EVORB	946.30	Oil Rubbed Bronze	3	
	OPTIONAL AC ADAPTERS SOLD SEPARATELY				
	169031	156.45	N/A or Unfinished	12	
	OPTIONAL WALL MOUNT & HOSE EXTENSION KIT SOLD SEPARATELY				
	199785	58.60	N/A or Unfinished	6	
	 POWERBOOST reflex DURALOCK® DURALAST®				





BELFIELD™		SMART FAUCET ONE-HANDLE KITCHEN PULLDOWN			
 <p>DECKPLATE INCLUDED</p> 	<ul style="list-style-type: none"> • application: one or three hole • spout height: 15.62" • connection: 3/8" compression • number of functions: four-function • spray type: aerated stream; powerful cleaning rinse; boosted rinse; boosted stream • handle mounting: right only • hose length: 68" • deckplate: included • DC powered: 6 D-cell batteries included • voice activated kitchen: compatible with Amazon Just Ask Alexa and Works with Google Assistant 	1.5 GPM (5.7 L/min) max.			
	7260EVC	776.75	Chrome	3	
	7260EVSRS●	854.45	Spot Resist Stainless	3	
	7260EVBL	893.25	Matte Black	3	
	7260EVORB	932.10	Oil Rubbed Bronze	3	
	OPTIONAL AC ADAPTERS SOLD SEPARATELY				
	169031	156.45	N/A or Unfinished	12	
	OPTIONAL WALL MOUNT & HOSE EXTENSION KIT SOLD SEPARATELY				
	199785	58.60	N/A or Unfinished	6	
	 POWERBOOST reflex DURALOCK® DURALAST®				





SLEEK®		SMART FAUCET ONE-HANDLE KITCHEN PULLDOWN			
 <p>DECKPLATE INCLUDED</p> 	<ul style="list-style-type: none"> • application: one or three hole • spout height: 15.56" • connection: 3/8" compression • number of functions: four-function • spray type: aerated stream; powerful cleaning rinse; boosted rinse; boosted stream • handle mounting: right only • hose length: 68" • deckplate: included • DC powered: 6 D-cell batteries included • voice activated kitchen: compatible with Amazon Just Ask Alexa and Works with Google Assistant 	1.5 GPM (5.7 L/min) max.			
	7864EVC	736.35	Chrome	3	
	7864EVSRS●	809.95	Spot Resist Stainless	3	
	7864EVBL	846.80	Matte Black	3	
	7864EVBS●	883.60	Black Stainless	3	
	7864EVBG	883.60	Brushed Gold	3	
	OPTIONAL AC ADAPTERS SOLD SEPARATELY				
	169031	156.45	N/A or Unfinished	12	
	OPTIONAL WALL MOUNT & HOSE EXTENSION KIT SOLD SEPARATELY				
	199785	58.60	N/A or Unfinished	6	
 POWERBOOST reflex DURALOCK® DURALAST®					



TOUCHLESS Kitchen Faucets



WEYMOUTH®		TOUCHLESS WITH MOTIONSENSE™ WAVE ONE-HANDLE SPRING KITCHEN PULLDOWN - PREMIUM			
  	<ul style="list-style-type: none"> spray wand: metal application: one hole spout height: 21.75" connection: 3/8" compression number of functions: two-function spray type: aerated stream; powerful cleaning rinse handle mounting: right only hose length: 68" DC powered: 6 AA cell batteries included includes: choice of matching finish or porcelain handle caps 	1.5 GPM (5.7 L/min) max.			
		MODEL	LIST	FINISH/CONNECT	CASE QTY
		S73104EWC	1013.90	Chrome	3
		S73104EWSRS●	1267.40	Spot Resist Stainless	3
		S73104EWBL	1318.10	Matte Black	3
		S73104EWNL	1368.80	Polished Nickel	3
		S73104EWORB	1419.50	Oil Rubbed Bronze	3
		S73104EWBG	1470.20	Brushed Gold	3
		OPTIONAL AC ADAPTERS SOLD SEPARATELY			
		169031	156.45	N/A or Unfinished	12
		OPTIONAL WALL MOUNT & HOSE EXTENSION KIT SOLD SEPARATELY			
		177566	48.10	N/A or Unfinished	6
		 POWER CLEAN DURALOCK® DURALAST® 			



SINEMA™		TOUCHLESS WITH MOTIONSENSE™ WAVE ONE-HANDLE SPRING KITCHEN PULLDOWN - PREMIUM			
  	<ul style="list-style-type: none"> spray wand: metal application: one hole spout height: 23.5" connection: 3/8" compression number of functions: two-function spray type: aerated stream; powerful cleaning rinse handle mounting: right only hose length: 68" two-tone art deco-inspired etched handle installed on faucet; secondary matching finish handle option included DC powered: 6 AA cell batteries included 	1.5 GPM (5.7 L/min) max.			
		MODEL	LIST	FINISH/CONNECT	CASE QTY
		S5235EWC	1030.40	Chrome	3
		S5235EWSRS●	1287.90	Spot Resist Stainless	3
		S5235EWBL	1339.50	Matte Black	3
		S5235EWNL	1391.00	Polished Nickel	3
		OPTIONAL AC ADAPTERS SOLD SEPARATELY			
		169031	156.45	N/A or Unfinished	12
		OPTIONAL WALL MOUNT & HOSE EXTENSION KIT SOLD SEPARATELY			
		177566	48.10	N/A or Unfinished	6
		 POWER CLEAN DURALOCK® DURALAST® 			



CIA™		TOUCHLESS WITH MOTIONSENSE™ WAVE ONE-HANDLE KITCHEN PULLDOWN			
 	<ul style="list-style-type: none"> application: one or three hole spout height: 16.86" connection: 3/8" compression number of functions: two-function spray type: aerated stream; powerful cleaning rinse handle mounting: right only hose length: 68" secondary accent escutcheon option included: chrome faucet has optional matte black; spot resist stainless has chrome; matte black has brushed gold and chrome; brushed gold has matte black DC powered: 6 AA cell batteries included 	1.5 GPM (5.7 L/min) max.			
		MODEL	LIST	FINISH/CONNECT	CASE QTY
		7622EWC	752.40	Chrome	3
		7622EWSRS●	940.50	Spot Resist Stainless	3
		7622EWBL	978.10	Matte Black	3
		7622EWBG	1090.95	Brushed Gold	3
		OPTIONAL DECKPLATE SOLD SEPARATELY			
		141002	56.60	Chrome	6
		141002SRS●	64.95	Spot Resist Stainless	6
		141002BL	64.95	Matte Black	6
		141002BG	64.95	Brushed Gold	6
		OPTIONAL AC ADAPTERS SOLD SEPARATELY			
		169031	156.45	N/A or Unfinished	12
		OPTIONAL WALL MOUNT & HOSE EXTENSION KIT SOLD SEPARATELY			
		177566	48.10	N/A or Unfinished	6
		 POWER CLEAN reflex  			

TOUCHLESS Kitchen Faucets



TOUCHLESS KITCHEN



MODEL	LIST	FINISH/CONNECT	CASE QTY
ALIGN® TOUCHLESS WITH <i>MOTIONSENSE™</i> WAVE ONE-HANDLE SPRING KITCHEN PULLDOWN			
1.5 GPM (5.7 L/min) max.			
	DECKPLATE SOLD SEPARATELY	<ul style="list-style-type: none"> • application: one or three hole • spout height: 21.75" • connection: 3/8" compression • number of functions: two-function • spray type: aerated stream; powerful cleaning rinse • handle mounting: right only • hose length: 68" • DC powered: 6 AA cell batteries included 	<ul style="list-style-type: none"> 5923EWC 794.75 Chrome 3 5923EWSRS● 993.40 Spot Resist Stainless 3 5923EWBL 1033.15 Matte Black 3 5923EWBLS● 1152.35 Black Stainless 3 5923EWBG 1152.35 Brushed Gold 3
OPTIONAL DECKPLATE SOLD SEPARATELY			
141002	56.60	Chrome	6
141002SRS●	64.95	Spot Resist Stainless	6
141002BL	64.95	Matte Black	6
141002BLS●	71.45	Black Stainless	6
141002BG	64.95	Brushed Gold	6
OPTIONAL AC ADAPTERS SOLD SEPARATELY			
169031	156.45	N/A or Unfinished	12
OPTIONAL WALL MOUNT & HOSE EXTENSION KIT SOLD SEPARATELY			
177566	48.10	N/A or Unfinished	6
 POWER CLEAN DURALOCK® DURALAST® 			



MODEL	LIST	FINISH/CONNECT	CASE QTY
ALIGN® TOUCHLESS WITH <i>MOTIONSENSE™</i> WAVE ONE-HANDLE KITCHEN PULLDOWN			
1.5 GPM (5.7 L/min) max.			
	DECKPLATE SOLD SEPARATELY	<ul style="list-style-type: none"> • application: one or three hole • spout height: 15.70" • connection: 3/8" compression • number of functions: two-function • spray type: aerated stream; powerful cleaning rinse • handle mounting: right only • hose length: 68" • DC powered: 6 AA cell batteries included 	<ul style="list-style-type: none"> 7565EWC 727.60 Chrome 3 7565EWSRS● 909.50 Spot Resist Stainless 3 7565EWBL 945.85 Matte Black 3 7565EWBLS● 1055.00 Black Stainless 3 7565EWBG 1055.00 Brushed Gold 3
OPTIONAL DECKPLATE SOLD SEPARATELY			
141002	56.60	Chrome	6
141002SRS●	64.95	Spot Resist Stainless	6
141002BL	64.95	Matte Black	6
141002BLS●	71.45	Black Stainless	6
141002BG	64.95	Brushed Gold	6
OPTIONAL AC ADAPTERS SOLD SEPARATELY			
169031	156.45	N/A or Unfinished	12
OPTIONAL WALL MOUNT & HOSE EXTENSION KIT SOLD SEPARATELY			
177566	48.10	N/A or Unfinished	6
 POWER CLEAN reflex DURALOCK® DURALAST®			



MODEL	LIST	FINISH/CONNECT	CASE QTY
KURV™ TOUCHLESS WITH <i>MOTIONSENSE™</i> WAVE ONE-HANDLE KITCHEN PULLDOWN			
1.5 GPM (5.7 L/min) max.			
	DECKPLATE SOLD SEPARATELY	<ul style="list-style-type: none"> • spray wand: metal • application: one or three hole • spout height: 16.38" • connection: 3/8" compression • number of functions: two-function • spray type: aerated stream; powerful cleaning rinse • handle mounting: right only • hose length: 68" • DC powered: 6 AA cell batteries included 	<ul style="list-style-type: none"> 9126EWC 710.15 Chrome 3 9126EWSRS● 887.70 Spot Resist Stainless 3 9126EWBL 923.20 Matte Black 3 9126EWNL 958.70 Polished Nickel 3
OPTIONAL DECKPLATE SOLD SEPARATELY			
141002	56.60	Chrome	6
141002SRS●	64.95	Spot Resist Stainless	6
141002BL	64.95	Matte Black	6
141002NL	61.60	Polished Nickel	6
OPTIONAL AC ADAPTERS SOLD SEPARATELY			
169031	156.45	N/A or Unfinished	12
OPTIONAL WALL MOUNT & HOSE EXTENSION KIT SOLD SEPARATELY			
177566	48.10	N/A or Unfinished	6
 POWER CLEAN reflex DURALOCK® DURALAST®			

TOUCHLESS Kitchen Faucets

BRANTFORD®		TOUCHLESS WITH MOTIONSENSE™ WAVE ONE-HANDLE KITCHEN PULLDOWN			
 DECKPLATE INCLUDED 	<ul style="list-style-type: none"> • application: one or three hole • spout height: 15.50" • connection: 3/8" compression • number of functions: two-function • spray type: powerful cleaning rinse; aerated stream • handle mounting: right only • hose length: 68" • deckplate: included • DC powered: 6 AA cell batteries: included 	1.5 GPM (5.7 L/min) max.			
		MODEL	LIST	FINISH/CONNECT	CASE QTY
		7185EWC	641.05	Chrome	3
		7185EWSRS●	801.30	Spot Resist Stainless	3
		7185EWORB	897.45	Oil Rubbed Bronze	3
		OPTIONAL AC ADAPTERS SOLD SEPARATELY			
		169031	156.45	N/A or Unfinished	12
		OPTIONAL WALL MOUNT & HOSE EXTENSION KIT SOLD SEPARATELY			
		177566	48.10	N/A or Unfinished	6
		 POWER CLEAN reflex DURALOCK® DURALAST®			









ARBOR®		TOUCHLESS WITH MOTIONSENSE™ WAVE ONE-HANDLE KITCHEN PULLDOWN			
 DECKPLATE INCLUDED 	<ul style="list-style-type: none"> • application: one or three hole • spout height: 15.50" • connection: 3/8" compression • number of functions: two-function • spray type: powerful cleaning rinse; aerated stream • handle mounting: right only • hose length: 68" • deckplate: included • DC powered: 6 AA cell batteries: included 	1.5 GPM (5.7 L/min) max.			
		MODEL	LIST	FINISH/CONNECT	CASE QTY
		7594EWC	618.90	Chrome	3
		7594EWSRS●	773.60	Spot Resist Stainless	3
		7594EWBL	804.55	Matte Black	3
		7594EWORB	866.45	Oil Rubbed Bronze	3
		OPTIONAL AC ADAPTERS SOLD SEPARATELY			
		169031	156.45	N/A or Unfinished	12
		OPTIONAL WALL MOUNT & HOSE EXTENSION KIT SOLD SEPARATELY			
		177566	48.10	N/A or Unfinished	6
		 POWER CLEAN reflex DURALOCK® DURALAST®			

BELFIELD™		TOUCHLESS WITH MOTIONSENSE™ WAVE ONE-HANDLE KITCHEN PULLDOWN			
 DECKPLATE INCLUDED 	<ul style="list-style-type: none"> • application: one or three hole • spout height: 15.62" • connection: 3/8" compression • number of functions: two-function • spray type: aerated stream; powerful cleaning rinse • handle mounting: right only • hose length: 68" • deckplate: included • DC powered: 6 AA cell batteries: included 	1.5 GPM (5.7 L/min) max.			
		MODEL	LIST	FINISH/CONNECT	CASE QTY
		7260EWC	607.30	Chrome	3
		7260EWSRS●	759.10	Spot Resist Stainless	3
		7260EWBL	789.45	Matte Black	3
		7260EWORB	850.20	Oil Rubbed Bronze	3
		OPTIONAL AC ADAPTERS SOLD SEPARATELY			
		169031	156.45	N/A or Unfinished	12
		OPTIONAL WALL MOUNT & HOSE EXTENSION KIT SOLD SEPARATELY			
		177566	48.10	N/A or Unfinished	6
		 POWER CLEAN reflex DURALOCK® DURALAST®			

GENTA™ LX		TOUCHLESS WITH MOTIONSENSE™ WAVE ONE-HANDLE KITCHEN PULLDOWN			
 DECKPLATE INCLUDED 	<ul style="list-style-type: none"> • application: one or three hole • spout height: 16.00" • connection: 3/8" compression • number of functions: two-function • spray type: aerated stream; powerful cleaning rinse • handle mounting: right only • hose length: 68" • deckplate: included • DC powered: 6 AA cell batteries: included 	1.5 GPM (5.7 L/min) max.			
		MODEL	LIST	FINISH/CONNECT	CASE QTY
		7882EWC	605.75	Chrome	3
		7882EWSRS●	757.20	Spot Resist Stainless	3
		7882EWBL	787.50	Matte Black	3
		OPTIONAL AC ADAPTERS SOLD SEPARATELY			
		169031	156.45	N/A or Unfinished	12
		OPTIONAL WALL MOUNT & HOSE EXTENSION KIT SOLD SEPARATELY			
		177566	48.10	N/A or Unfinished	6
		 POWER CLEAN reflex DURALOCK® DURALAST®			

TOUCHLESS Kitchen Faucets

TOUCHLESS KITCHEN

		MODEL	LIST	FINISH/CONNECT	CASE QTY
SLEEK® TOUCHLESS WITH MOTIONSENSE™ WAVE ONE-HANDLE SPRING KITCHEN PULLDOWN					
 DECKPLATE INCLUDED 	<ul style="list-style-type: none"> • application: one or three hole • spout height: 23.25" • connection: 3/8" compression • number of functions: two-function • spray type: aerated stream; powerful cleaning rinse • handle mounting: right only • hose length: 68" • deckplate: included • DC powered: 6 AA cell batteries included 	1.5 GPM (5.7 L/min) max.			
			<ul style="list-style-type: none"> • application: one or three hole • spout height: 15.56" • connection: 3/8" compression • number of functions: two-function • spray type: aerated stream; powerful cleaning rinse • handle mounting: right only • hose length: 68" • deckplate: included • DC powered: 6 AA cell batteries: included 	5925EWC 5925EWSRS● 5925EWBL 5925EWBLS	 653.50 816.80 849.50 947.50
OPTIONAL AC ADAPTERS SOLD SEPARATELY					
		169031	156.45	N/A or Unfinished	12
OPTIONAL WALL MOUNT & HOSE EXTENSION KIT SOLD SEPARATELY					
		177566	48.10	N/A or Unfinished	6
 POWER CLEAN DURALOCK® DURALAST® 					
SLEEK® TOUCHLESS WITH MOTIONSENSE™ WAVE ONE-HANDLE KITCHEN PULLDOWN					
 DECKPLATE INCLUDED	<ul style="list-style-type: none"> • application: one or three hole • spout height: 15.56" • connection: 3/8" compression • number of functions: two-function • spray type: aerated stream; powerful cleaning rinse • handle mounting: right only • hose length: 68" • deckplate: included • DC powered: 6 AA cell batteries: included 	1.5 GPM (5.7 L/min) max.			
			<ul style="list-style-type: none"> • application: one or three hole • spout height: 15.56" • connection: 3/8" compression • number of functions: two-function • spray type: aerated stream; powerful cleaning rinse • handle mounting: right only • hose length: 68" • deckplate: included • DC powered: 6 AA cell batteries: included 	7864EWC 7864EWSRS● 7864EWBL 7864EWBLS● 7864EWBG	 567.55 709.40 737.80 822.90 822.90
OPTIONAL AC ADAPTERS SOLD SEPARATELY					
		169031	156.45	N/A or Unfinished	12
OPTIONAL WALL MOUNT & HOSE EXTENSION KIT SOLD SEPARATELY					
		177566	48.10	N/A or Unfinished	6
 POWER CLEAN reflex™ DURALOCK® DURALAST®					

KITCHEN AND BAR FAUCETS



Premium Kitchen Faucets

KITCHEN

Nio™

STō®

Apphia™ **NEW!**

Weymouth®



Sinema™





Paterson™

Premium Kitchen Faucets

Bring elegance to your home with premium kitchen faucet selections from Moen. From the sophistication of period traditional to the streamlined refinement of minimalist contemporary, you'll find a host of amazing ways to be expressive in the kitchen.





	MODEL	LIST	FINISH/CONNECT	CASE QTY
NIO™	SMART FAUCET WITH MOTION CONTROL HANDLE-FREE KITCHEN PULLDOWN - PREMIUM			
NEW! Q3	1.5 GPM (5.7 L/min) max.			
 <ul style="list-style-type: none"> • application: one hole • spout height: 18.38" • connection: 3/8" compression • number of functions: four-function • spray type: aerated stream; powerful cleaning rinse; boosted rinse; boosted stream • hose length: 68" • AC adapter included • DC powered: 6 D-cell batteries included • voice activated kitchen: compatible with Amazon Just Ask Alexa and Works with Google Assistant 	S70005EV2C	1213.05	Chrome	3
	S70005EV2SRS●	1334.35	Spot Resist Stainless	3
	S70005EV2BL	1395.05	Matte Black	3
	S70005EV2BLS	1455.70	Black Stainless	3
	OPTIONAL WALL MOUNT & HOSE EXTENSION KIT SOLD SEPARATELY			
	199785	58.60	N/A or Unfinished	6
 POWERBOOST reflex  DURALOCK® DURALAST®				



	MODEL	LIST	FINISH/CONNECT	CASE QTY
NIO™	SMART FAUCET WITH MOTION CONTROL ONE-HANDLE KITCHEN PULLDOWN - PREMIUM			
  <ul style="list-style-type: none"> • application: one hole • spout height: 18.38" • connection: 3/8" compression • number of functions: four-function • spray type: aerated stream; powerful cleaning rinse; boosted rinse; boosted stream • handle mounting: right only • hose length: 68" • secondary two-tone handle option included: chrome faucet has matte black handle; matte black faucet has brushed gold handle; spot resist faucet has matte black handle; black stainless faucet has spot resist stainless handle • AC adapter included • DC powered: 6 D-cell batteries included • voice activated kitchen: compatible with Amazon Just Ask Alexa and Works with Google Assistant 	1.5 GPM (5.7 L/min) max.			
	S75005EV2C	1160.85	Chrome	3
	S75005EV2SRS●	1276.95	Spot Resist Stainless	3
	S75005EV2BL	1335.00	Matte Black	3
	S75005EV2BLS●	1393.00	Black Stainless	3
OPTIONAL WALL MOUNT & HOSE EXTENSION KIT SOLD SEPARATELY				
	199785	58.60	N/A or Unfinished	6
 POWERBOOST reflex  DURALOCK® DURALAST®				





Premium Kitchen Faucets

	MODEL	LIST	FINISH/CONNECT	CASE QTY
NIO™	SMART FAUCET ONE-HANDLE KITCHEN PULLDOWN - PREMIUM			
	<ul style="list-style-type: none"> • application: one hole • spout height: 18.38" • connection: 3/8" compression • number of functions: four-function • spray type: aerated stream; powerful cleaning rinse; boosted rinse; boosted stream • handle mounting: right only • hose length: 68" • secondary two-tone handle option included: chrome faucet has matte black handle; matte black faucet has brushed gold handle; spot resist faucet has matte black handle; black stainless faucet has spot resist stainless handle • DC powered: 6 D-cell batteries included • voice activated kitchen: compatible with Amazon Just Ask Alexa and Works with Google Assistant 			
	1.5 GPM (5.7 L/min) max.			
	S75005EVC	1152.25	Chrome	3
	S75005EVSRS●	1267.45	Spot Resist Stainless	3
	S75005EVBL	1325.05	Matte Black	3
	S75005EVBLS●	1382.70	Black Stainless	3
	OPTIONAL AC ADAPTERS SOLD SEPARATELY			
	169031	156.45	N/A or Unfinished	12
	OPTIONAL WALL MOUNT & HOSE EXTENSION KIT SOLD SEPARATELY			
	199785	58.60	N/A or Unfinished	6
				

	MODEL	LIST	FINISH/CONNECT	CASE QTY
NIO™	ONE-HANDLE KITCHEN PULLDOWN - PREMIUM			
	<ul style="list-style-type: none"> • application: one hole • spout height: 18.38" • connection: 3/8" compression • number of functions: four-function • spray type: aerated stream; powerful cleaning rinse; boosted rinse; boosted stream • handle mounting: right only • hose length: 68" • secondary two-tone handle option included: chrome faucet has matte black handle; matte black faucet has brushed gold handle; spot resist faucet has matte black handle; black stainless faucet has spot resist stainless handle 			
	1.5 GPM (5.7 L/min) max.			
	S75005	825.25	Chrome	3
	S75005SRS●	1031.55	Spot Resist Stainless	3
	S75005BL	1072.80	Matte Black	3
	S75005BLS●	1196.60	Black Stainless	3
				

	MODEL	LIST	FINISH/CONNECT	CASE QTY
STō®	SMART FAUCET ONE-HANDLE KITCHEN PULLDOWN - PREMIUM			
	<ul style="list-style-type: none"> • application: one hole • spout height: 17.25" • connection: 3/8" compression • number of functions: four-function • powerboost wand concealed in spout • spray type: aerated stream; powerful cleaning rinse; boosted rinse; boosted stream • handle mounting: right only • hose length: 68" • DC powered: 6 D-cell batteries included • voice activated kitchen: compatible with Amazon Just Ask Alexa and Works with Google Assistant 			
	1.5 GPM (5.7 L/min) max.			
	S72308EVC	1151.10	Chrome	3
	S72308EVSRS●	1266.20	Spot Resist Stainless	3
	S72308EVBL	1323.75	Matte Black	3
	S72308EVBG	1381.30	Brushed Gold	3
	OPTIONAL AC ADAPTERS SOLD SEPARATELY			
	169031	156.45	N/A or Unfinished	12
	OPTIONAL WALL MOUNT & HOSE EXTENSION KIT SOLD SEPARATELY			
	199785	58.60	N/A or Unfinished	6
				

	MODEL	LIST	FINISH/CONNECT	CASE QTY
STō®	ONE-HANDLE KITCHEN PULLDOWN - PREMIUM			
	<ul style="list-style-type: none"> • application: one hole • spout height: 17.25" • connection: 3/8" compression • number of functions: four-function • powerboost wand concealed in spout • spray type: aerated stream; powerful cleaning rinse; boosted rinse; boosted stream • handle mounting: right only • hose length: 68" 			
	1.5 GPM (5.7 L/min) max.			
	S72308	820.30	Chrome	3
	S72308SRS●	1025.40	Spot Resist Stainless	3
	S72308BL	1066.40	Matte Black	3
	S72308BG	1189.45	Brushed Gold	3
	S72308BLC	1230.45	Matte Black/Chrome	3
				





KITCHEN

Premium Kitchen Faucets





	MODEL	LIST	FINISH/CONNECT	CASE QTY
APPHIA™ SMART FAUCET WITH MOTION CONTROL HANDLE-FREE KITCHEN PULLDOWN - PREMIUM				
 <p>NEW! Q3</p> <ul style="list-style-type: none"> spray wand: metal application: one hole spout height: 21.75" connection: 3/8" compression number of functions: four-function spray type: aerated stream; powerful cleaning rinse; boosted rinse; boosted stream handle mounting: right only hose length: 68" DC powered: 6 AA cell batteries included <p>POWERBOOST reflex DURALOCK® DURALAST®</p>	1.5 GPM (5.7 L/min) max.			
	S70909EV2CH	1276.90	Chrome	3
	S70909EV2SRS●	1404.60	Spot Resist Stainless	3
	S70909EV2BL	1468.45	Matte Black	3
	S70909EV2NL	1532.30	Polished Nickel	3
	S70909EV2BG	1532.30	Brushed Gold	3
	OPTIONAL WALL MOUNT & HOSE EXTENSION KIT SOLD SEPARATELY			
	199785	58.60	N/A or Unfinished	6





	MODEL	LIST	FINISH/CONNECT	CASE QTY
WEYMOUTH® SMART FAUCET WITH MOTION CONTROL ONE-HANDLE KITCHEN PULLDOWN - PREMIUM				
 <ul style="list-style-type: none"> spray wand: metal application: one hole spout height: 17.00" connection: 3/8" compression number of functions: four-function spray type: aerated stream; powerful cleaning rinse; boosted rinse; boosted stream handle mounting: right only hose length: 68" includes: choice of matching finish or porcelain handle caps AC adapter included DC powered: 6 D-cell batteries included voice activated kitchen: compatible with Amazon Just Ask Alexa and Works with Google Assistant <p>POWERBOOST reflex DURALOCK® DURALAST®</p>	1.5 GPM (5.7 L/min) max.			
	S73004EV2C	1042.25	Chrome	3
	S73004EV2SRS●	1146.50	Spot Resist Stainless	3
	S73004EV2BL	1198.60	Matte Black	3
	S73004EV2NL	1250.70	Polished Nickel	3
	S73004EV2ORB	1250.70	Oil Rubbed Bronze	3
	S73004EV2BG	1250.70	Brushed Gold	3
	OPTIONAL WALL MOUNT & HOSE EXTENSION KIT SOLD SEPARATELY			
	199785	58.60	N/A or Unfinished	6



	MODEL	LIST	FINISH/CONNECT	CASE QTY
WEYMOUTH® SMART FAUCET ONE-HANDLE KITCHEN PULLDOWN - PREMIUM				
 <ul style="list-style-type: none"> spray wand: metal application: one hole spout height: 17.00" connection: 3/8" compression number of functions: four-function spray type: aerated stream; powerful cleaning rinse; boosted rinse; boosted stream handle mounting: right only hose length: 68" includes: choice of matching finish or porcelain handle caps DC powered: 6 D-cell batteries included voice activated kitchen: compatible with Amazon Just Ask Alexa and Works with Google Assistant <p>POWERBOOST reflex DURALOCK® DURALAST®</p>	1.5 GPM (5.7 L/min) max.			
	S73004EVC	1031.95	Chrome	3
	S73004EVSRS●	1135.15	Spot Resist Stainless	3
	S73004EVBL	1186.75	Matte Black	3
	S73004EVNL	1238.35	Polished Nickel	3
	S73004EVORB	1238.35	Oil Rubbed Bronze	3
	S73004EVBG	1238.35	Brushed Gold	3
	OPTIONAL AC ADAPTERS SOLD SEPARATELY			
	169031	156.45	N/A or Unfinished	12
	OPTIONAL WALL MOUNT & HOSE EXTENSION KIT SOLD SEPARATELY			
199785	58.60	N/A or Unfinished	6	



	MODEL	LIST	FINISH/CONNECT	CASE QTY
WEYMOUTH® TWO-HANDLE KITCHEN BRIDGE PULLDOWN - PREMIUM				
 <ul style="list-style-type: none"> spray wand: metal application: three hole spout height: 16.75" connection: 3/8" compression number of functions: four-function spray type: aerated stream; powerful cleaning rinse; boosted rinse; boosted stream hose length: 68" handle: two-handle spout: pulldown secondary cross handle option: included includes: choice of matching finish or porcelain handle caps <p>POWERBOOST reflex DURALOCK® DURALAST®</p>	1.5 GPM (5.7 L/min) max.			
	S73204	1015.95	Chrome	3
	S73204SRS●	1269.90	Spot Resist Stainless	3
	S73204BL	1320.70	Matte Black	3
	S73204NL	1371.50	Polished Nickel	3
	S73204ORB	1422.30	Oil Rubbed Bronze	3
	S73204BG	1473.10	Brushed Gold	3

Premium Kitchen Faucets

WEYMOUTH®		TOUCHLESS WITH <i>MOTIONSENSE™ WAVE</i> ONE-HANDLE SPRING KITCHEN PULLDOWN - PREMIUM				
 	NEW! Q3	<ul style="list-style-type: none"> spray wand: metal application: one hole spout height: 21.75" connection: 3/8" compression number of functions: four-function spray type: aerated stream; powerful cleaning rinse; boosted rinse; boosted stream handle mounting: right only hose length: 68" DC powered: 6 AA cell batteries included includes: choice of matching finish or porcelain handle caps 	1.5 GPM (5.7 L/min) max.			
			S73104EWC	1013.90	Chrome	3
			S73104EWSRS●	1267.40	Spot Resist Stainless	3
			S73104EWBL	1318.10	Matte Black	3
			S73104EWNL	1368.80	Polished Nickel	3
			S73104EWORB	1419.50	Oil Rubbed Bronze	3
			S73104EWBG	1470.20	Brushed Gold	3
			OPTIONAL AC ADAPTERS SOLD SEPARATELY			
			169031	156.45	N/A or Unfinished	12
			OPTIONAL WALL MOUNT & HOSE EXTENSION KIT SOLD SEPARATELY			
		177566	48.10	N/A or Unfinished	6	
		 POWER CLEAN® DURALOCK® DURALAST® 				

WEYMOUTH®		ONE-HANDLE KITCHEN SPRING PULLDOWN - PREMIUM				
 		<ul style="list-style-type: none"> spray wand: metal application: one hole spout height: 21.75" connection: 3/8" compression number of functions: four-function spray type: aerated stream; powerful cleaning rinse; boosted rinse; boosted stream handle mounting: right only hose length: 68" included: choice of matching finish or porcelain handle cap 	1.5 GPM (5.7 L/min) max.			
			S73104	863.90	Chrome	3
			S73104SRS●	1079.85	Spot Resist Stainless	3
			S73104BL	1123.05	Matte Black	3
			S73104NL	1166.25	Polished Nickel	3
			S73104ORB	1209.45	Oil Rubbed Bronze	3
			S73104BG	1252.65	Brushed Gold	3
			 POWERBOOST® DURALOCK® DURALAST® 			

WEYMOUTH®		3-IN-1 WATER FILTRATION PULLDOWN KITCHEN FAUCET - PREMIUM				
 	NEW! Q3	<ul style="list-style-type: none"> water filtration at the spray wand spray wand: metal application: one hole spout height: 16.73" connection: 3/8" compression number of functions: three-function spray type: filtered laminar stream; unfiltered aerated stream; unfiltered PowerClean spray handle mounting: right only hose length: 68" included: choice of matching finish or porcelain handle cap 	1.5 GPM (5.7 L/min) max.			
			FS73004	784.40	Chrome	3
			FS73004SRS●	980.50	Spot Resist Stainless	3
			FS73004NL	1058.90	Polished Nickel	3
			FS73004ORB	1098.15	Oil Rubbed Bronze	3
			FS73004BG	1137.35	Brushed Gold	3
			 reflex™ DURALOCK® DURALAST®			

WEYMOUTH®		ONE-HANDLE KITCHEN PULLDOWN - PREMIUM				
 		<ul style="list-style-type: none"> spray wand: metal application: one hole spout height: 17" connection: 3/8" compression number of functions: four-function spray type: aerated stream; powerful cleaning rinse; boosted rinse; boosted stream handle mounting: right only hose length: 68" included: choice of matching finish or porcelain handle cap 	1.5 GPM (5.7 L/min) max.			
			S73004	704.95	Chrome	3
			S73004SRS●	881.20	Spot Resist Stainless	3
			S73004BL	916.45	Matte Black	3
			S73004NL	951.70	Polished Nickel	3
			S73004ORB	986.95	Oil Rubbed Bronze	3
			S73004BG	1022.20	Brushed Gold	3
			 POWERBOOST reflex™ DURALOCK® DURALAST®			







Premium Kitchen Faucets





MODEL LIST FINISH/CONNECT CASE QTY





SINEMA™		SMART FAUCET WITH MOTION CONTROL ONE-HANDLE KITCHEN PULLDOWN - PREMIUM			
 	<ul style="list-style-type: none"> • spray wand: metal • application: one hole • spout height: 17.75" • connection: 3/8" compression • number of functions: four-function • spray type: aerated stream; powerful cleaning rinse; boosted rinse; boosted stream • handle mounting: right only • hose length: 68" • two-tone art deco-inspired etched handle installed on faucet; secondary matching finish handle option included • AC adapter included • DC powered: 6 D-cell batteries included • voice activated kitchen: compatible with Amazon Just Ask Alexa and Works with Google Assistant 	1.5 GPM (5.7 L/min) max.			
	S7235EV2C	1174.75	Chrome	3	
	S7235EV2SRS●	1292.20	Spot Resist Stainless	3	
	S7235EV2BL	1350.95	Matte Black	3	
	S7235EV2NL	1409.70	Polished Nickel	3	
OPTIONAL WALL MOUNT & HOSE EXTENSION KIT SOLD SEPARATELY					
199785	58.60	N/A or Unfinished	6		
 POWERBOOST reflex 					





SINEMA™		SMART FAUCET ONE-HANDLE KITCHEN PULLDOWN - PREMIUM			
 	<ul style="list-style-type: none"> • spray wand: metal • application: one hole • spout height: 17.75" • connection: 3/8" compression • number of functions: four-function • spray type: aerated stream; powerful cleaning rinse; boosted rinse; boosted stream • handle mounting: right only • hose length: 68" • two-tone art deco-inspired etched handle installed on faucet; secondary matching finish handle option included • DC powered: 6 D-cell batteries included • voice activated kitchen: compatible with Amazon Just Ask Alexa and Works with Google Assistant 	1.5 GPM (5.7 L/min) max.			
	S7235EVC	1004.15	Chrome	3	
	S7235EVSRS●	1104.60	Spot Resist Stainless	3	
	S7235EVBL	1154.80	Matte Black	3	
	S7235EVNL	1205.00	Polished Nickel	3	
OPTIONAL AC ADAPTERS SOLD SEPARATELY					
169031	156.45	N/A or Unfinished	12		
OPTIONAL WALL MOUNT & HOSE EXTENSION KIT SOLD SEPARATELY					
199785	58.60	N/A or Unfinished	6		
 POWERBOOST reflex 					

SINEMA™		TOUCHLESS WITH MOTIONSENSE™ WAVE ONE-HANDLE SPRING KITCHEN PULLDOWN - PREMIUM			
 	<ul style="list-style-type: none"> • spray wand: metal • application: one hole • spout height: 23.5" • connection: 3/8" compression • number of functions: two-function • spray type: aerated stream; powerful cleaning rinse • handle mounting: right only • hose length: 68" • two-tone art deco-inspired etched handle installed on faucet; secondary matching finish handle option included • DC powered: 6 AA cell batteries included 	1.5 GPM (5.7 L/min) max.			
	S5235EWC	1030.40	Chrome	3	
	S5235EWSRS●	1287.90	Spot Resist Stainless	3	
	S5235EWBL	1339.50	Matte Black	3	
	S5235EWNL	1391.00	Polished Nickel	3	
OPTIONAL AC ADAPTERS SOLD SEPARATELY					
169031	156.45	N/A or Unfinished	12		
OPTIONAL WALL MOUNT & HOSE EXTENSION KIT SOLD SEPARATELY					
177566	48.10	N/A or Unfinished	6		
 POWER CLEAN 					

Premium Kitchen Faucets

	MODEL	LIST	FINISH/CONNECT	CASE QTY
SINEMA™ ONE-HANDLE KITCHEN SPRING PULLDOWN – PREMIUM				
	1.5 GPM (5.7 L/min) max.			
	S5235	880.35	Chrome	3
	S5235SRS●	1100.40	Spot Resist Stainless	3
	S5235BL	1144.45	Matte Black	3
	S5235NL	1188.45	Polished Nickel	3
<ul style="list-style-type: none"> • spray wand: metal • application: one hole • spout height: 23.5" • connection: 3/8" compression • number of functions: four-function • spray type: aerated stream; powerful cleaning rinse; boosted rinse; boosted stream • handle mounting: right only • hose length: 69" • two-tone art deco-inspired etched handle installed on faucet; secondary matching finish handle option included 				
 POWERBOOST  DURALOCK®  DURALAST® 				



SINEMA™ 3-IN-1 WATER FILTRATION PULLDOWN KITCHEN FAUCET – PREMIUM				
 <p>NEW! Q3</p>	1.5 GPM (5.7 L/min) max.			
	FS7235	780.70	Chrome	3
	FS7235SRS●	975.90	Spot Resist Stainless	3
	FS7235BL	1014.95	Matte Black	3
<ul style="list-style-type: none"> • water filtration at the spray wand • spray wand: metal • application: one hole • spout height: 17.75" • connection: 3/8" compression • number of functions: three-function • spray type: filtered laminar stream; unfiltered aerated stream; unfiltered PowerClean spray • handle mounting: right only • hose length: 68" • two-tone art deco-inspired etched handle installed on faucet; secondary matching finish handle option included 				
 reflex  DURALOCK®  DURALAST®				



SINEMA™ ONE-HANDLE KITCHEN PULLDOWN – PREMIUM				
	1.5 GPM (5.7 L/min) max.			
	S7235	677.15	Chrome	3
	S7235SRS●	846.45	Spot Resist Stainless	3
	S7235BL	880.30	Matte Black	3
	S7235NL	914.15	Polished Nickel	3
<ul style="list-style-type: none"> • spray wand: metal • application: one hole • spout height: 17.75" • connection: 3/8" compression • number of functions: four-function • spray type: aerated stream; powerful cleaning rinse; boosted rinse; boosted stream • handle mounting: right only • hose length: 68" • two-tone art deco-inspired etched handle installed on faucet; secondary matching finish handle option included 				
 POWERBOOST  reflex  DURALOCK®  DURALAST®				



PATERSON™ SMART FAUCET WITH MOTION CONTROL ONE-HANDLE KITCHEN PULLDOWN – PREMIUM				
	1.5 GPM (5.7 L/min) max.			
	S72003EV2C	1021.30	Chrome	3
	S72003EV2SRS●	1123.40	Spot Resist Stainless	3
	S72003EV2BL	1174.45	Matte Black	3
<ul style="list-style-type: none"> • application: one hole • spout height: 17.00" • connection: 3/8" compression • number of functions: four-function • spray type: aerated stream; powerful cleaning rinse; boosted rinse; boosted stream • handle mounting: right only • secondary wheel handle option: included • hose length: 68" • AC adapter included • DC powered: 6 D-cell batteries included • voice activated kitchen: compatible with Amazon Just Ask Alexa and Works with Google Assistant 				
<p>OPTIONAL WALL MOUNT & HOSE EXTENSION KIT SOLD SEPARATELY</p>				
199785		58.60	N/A or Unfinished	6
 POWERBOOST  reflex  DURALOCK®  DURALAST®				



Premium Kitchen Faucets

KITCHEN

		MODEL	LIST	FINISH/CONNECT	CASE QTY
PATERSON™ SMART FAUCET ONE-HANDLE KITCHEN PULLDOWN – PREMIUM					
 	<ul style="list-style-type: none"> • spray wand: metal • application: one hole • spout height: 17.00" • connection: 3/8" compression • number of functions: four-function • spray type: aerated stream; powerful cleaning rinse; boosted rinse; boosted stream • handle mounting: right only • hose length: 68" • secondary wheel handle option: included • DC powered: 6 D-cell batteries included • voice activated kitchen: compatible with Amazon Just Ask Alexa and Works with Google Assistant 	1.5 GPM (5.7 L/min) max.			
		S72003EVC	1011.20	Chrome	3
		S72003EVSRS●	1112.30	Spot Resist Stainless	3
		S72003EVBL	1162.85	Matte Black	3
OPTIONAL AC ADAPTERS SOLD SEPARATELY					
	169031	156.45	N/A or Unfinished	12	
OPTIONAL WALL MOUNT & HOSE EXTENSION KIT SOLD SEPARATELY					
	199785	58.60	N/A or Unfinished	6	
 POWERBOOST reflex DURALOCK® DURALAST®					

		MODEL	LIST	FINISH/CONNECT	CASE QTY
PATERSON™ 3-IN-1 WATER FILTRATION PULLDOWN KITCHEN FAUCET – PREMIUM					
 	<ul style="list-style-type: none"> • water filtration at the spray wand • spray wand: metal • application: one hole • spout height: 17.00" • connection: 3/8" compression • number of functions: three-function • spray type: filtered laminar stream; unfiltered aerated stream; unfiltered PowerClean spray • handle mounting: right only • hose length: 68" • secondary wheel handle option: included 	1.5 GPM (5.7 L/min) max.			
		FS72003	765.55	Chrome	3
		FS72003SRS●	956.95	Spot Resist Stainless	3
		FS72003BL	995.25	Matte Black	3
 reflex DURALOCK® DURALAST®					

		MODEL	LIST	FINISH/CONNECT	CASE QTY
PATERSON™ ONE-HANDLE KITCHEN SPRING PULLDOWN – PREMIUM					
 	<ul style="list-style-type: none"> • spray wand: metal • application: one hole • spout height: 22.37" • connection: 3/8" compression • number of functions: four-function • spray type: aerated stream; powerful cleaning rinse; boosted rinse; boosted stream • handle mounting: right only • hose length: 68" • secondary wheel handle option: included 	1.5 GPM (5.7 L/min) max.			
		S72103	850.10	Chrome	3
		S72103SRS●	1062.60	Spot Resist Stainless	3
		S72103BL	1105.10	Matte Black	3
 POWERBOOST DURALOCK® DURALAST® (3x)					

		MODEL	LIST	FINISH/CONNECT	CASE QTY
PATERSON™ ONE-HANDLE KITCHEN PULLDOWN – PREMIUM					
 	<ul style="list-style-type: none"> • spray wand: metal • application: one hole • spout height: 17.00" • connection: 3/8" compression • number of functions: four-function • spray type: aerated stream; powerful cleaning rinse; boosted rinse; boosted stream • handle mounting: right only • hose length: 68" • secondary wheel handle option: included 	1.5 GPM (5.7 L/min) max.			
		S72003	684.20	Chrome	3
		S72003SRS●	855.25	Spot Resist Stainless	3
		S72003BL	889.45	Matte Black	3
 POWERBOOST reflex DURALOCK® DURALAST®					





- Cia™
- Align®
- KURV™
- Brantford®
- Arbor®
- Belfield™
- Genta™ LX
- Sleek®
- Camerist®
- Integra®
- Method™
- Chateau®
- Banbury®



Kitchen Faucets

Moen® kitchen faucets combine meaningful innovations with an exceptional variety of attractive styles and in a wide array of finishes. With almost limitless design possibilities, kitchen faucets from Moen offer design, functionality and value.



KITCHEN



CIA™		MODEL	LIST	FINISH/CONNECT	CASE QTY
SMART FAUCET ONE-HANDLE KITCHEN PULLDOWN		1.5 GPM (5.7 L/min) max.			
	DECKPLATE SOLD SEPARATELY	7622EVC	913.65	Chrome	3
		7622EVSRS●	1005.00	Spot Resist Stainless	3
	<ul style="list-style-type: none"> • application: one or three hole • spout height: 16.86" • connection: 3/8" compression • number of functions: four-function • spray type: aerated stream; powerful cleaning rinse; boosted rinse; boosted stream • handle mounting: right only • hose length: 68" • secondary accent escutcheon option included: chrome faucet has optional matte black; spot resist stainless has chrome; matte black has brushed gold and chrome; brushed gold has matte black • DC powered: 6 D-cell batteries included • voice activated kitchen: compatible with Amazon Just Ask Alexa and Works with Google Assistant 	7622EVB�	1050.70	Matte Black	3
		7622EVBG	1096.35	Brushed Gold	3
		OPTIONAL DECKPLATE SOLD SEPARATELY			
		141002	56.60	Chrome	6
		141002SRS●	64.95	Spot Resist Stainless	6
		141002BL	64.95	Matte Black	6
		141002BG	64.95	Brushed Gold	6
OPTIONAL AC ADAPTERS SOLD SEPARATELY					
		169031	156.45	N/A or Unfinished	12
OPTIONAL WALL MOUNT & HOSE EXTENSION KIT SOLD SEPARATELY					
		199785	58.60	N/A or Unfinished	6
 POWERBOOST reflex DURALOCK® DURALAST®					



CIA™		MODEL	LIST	FINISH/CONNECT	CASE QTY
TOUCHLESS WITH MOTIONSENSE™ WAVE ONE-HANDLE KITCHEN PULLDOWN		1.5 GPM (5.7 L/min) max.			
	DECKPLATE SOLD SEPARATELY	7622EWC	752.40	Chrome	3
		7622EWSRS●	940.50	Spot Resist Stainless	3
	<ul style="list-style-type: none"> • application: one or three hole • spout height: 16.86" • connection: 3/8" compression • number of functions: two-function • spray type: aerated stream; powerful cleaning rinse • handle mounting: right only • hose length: 68" • secondary accent escutcheon option included: chrome faucet has optional matte black; spot resist stainless has chrome; matte black has brushed gold and chrome; brushed gold has matte black • DC powered: 6 AA cell batteries included 	7622EWBL	978.10	Matte Black	3
		7622EWBG	1090.95	Brushed Gold	3
		OPTIONAL DECKPLATE SOLD SEPARATELY			
		141002	56.60	Chrome	6
		141002SRS●	64.95	Spot Resist Stainless	6
		141002BL	64.95	Matte Black	6
		141002BG	64.95	Brushed Gold	6
OPTIONAL AC ADAPTERS SOLD SEPARATELY					
		169031	156.45	N/A or Unfinished	12
OPTIONAL WALL MOUNT & HOSE EXTENSION KIT SOLD SEPARATELY					
		177566	48.10	N/A or Unfinished	6
 MOTIONSENSE POWER CLEAN reflex DURALOCK® DURALAST®					





Kitchen Faucets

KITCHEN





CIA™		ONE-HANDLE KITCHEN SPRING PULLDOWN	MODEL	LIST	FINISH/CONNECT	CASE QTY
DECKPLATE SOLD SEPARATELY NEW! Q3 	<ul style="list-style-type: none"> • application: one or three hole • spout height: 24.50" • connection: 3/8" compression • number of functions: four-function • spray type: aerated stream; powerful cleaning rinse; boosted rinse; boosted stream • bi-directional PowerBoost Pro togglelock • magnetix wand docking • handle mounting: right only • hose length: 68" • secondary accent escutcheon option included: chrome faucet has optional matte black; spot resist stainless has chrome; matte black has brushed gold and chrome; brushed gold has matte black 	1.5 GPM aerated/1.5 laminar				
		7822	850.00	Chrome	3	
		7822SRS●	1062.50	Spot Resist Stainless	3	
		7822BL	1105.00	Matte Black	3	
		7822BG	1232.50	Brushed Gold	3	
OPTIONAL DECKPLATE SOLD SEPARATELY						
		141002	56.60	Chrome	6	
		141002SRS●	64.95	Spot Resist Stainless	6	
		141002BL	64.95	Matte Black	6	
		141002BG	64.95	Brushed Gold	6	
						



CIA™		ONE-HANDLE KITCHEN PULLDOWN	MODEL	LIST	FINISH/CONNECT	CASE QTY
DECKPLATE SOLD SEPARATELY 	<ul style="list-style-type: none"> • application: one or three hole • spout height: 16.86" • connection: 3/8" compression • number of functions: four-function • spray type: aerated stream; powerful cleaning rinse; boosted rinse; boosted stream • handle mounting: right only • hose length: 68" • secondary accent escutcheon option included: chrome faucet has optional matte black; spot resist stainless has chrome; matte black has brushed gold and chrome; brushed gold has matte black 	1.5 GPM (5.7 L/min) max.				
		7622	591.15	Chrome	3	
		7622SRS●	738.95	Spot Resist Stainless	3	
		7622BL	768.50	Matte Black	3	
		7622BG	857.15	Brushed Gold	3	
OPTIONAL DECKPLATE SOLD SEPARATELY						
		141002	56.60	Chrome	6	
		141002SRS●	64.95	Spot Resist Stainless	6	
		141002BL	64.95	Matte Black	6	
		141002BG	64.95	Brushed Gold	6	
						





ALIGN®		SMART FAUCET ONE-HANDLE KITCHEN PULLDOWN	MODEL	LIST	FINISH/CONNECT	CASE QTY		
DECKPLATE SOLD SEPARATELY 	<ul style="list-style-type: none"> • application: one or three hole • spout height: 15.70" • connection: 3/8" compression • number of functions: four-function • spray type: aerated stream; powerful cleaning rinse; boosted rinse; boosted stream • handle mounting: right only • hose length: 68" • DC powered: 6 D-cell batteries included • voice activated kitchen: compatible with Amazon Just Ask Alexa and Works with Google Assistant 	1.5 GPM (5.7 L/min) max.						
		7565EVC	889.60	Chrome	3			
		7565EVSRS●	978.55	Spot Resist Stainless	3			
		7565EVBL	1023.05	Matte Black	3			
		7565EVBLS●	1067.50	Black Stainless	3			
		7565EVBG	1067.50	Brushed Gold	3			
		OPTIONAL DECKPLATE SOLD SEPARATELY						
				141002	56.60	Chrome	6	
				141002SRS●	64.95	Spot Resist Stainless	6	
				141002BL	64.95	Matte Black	6	
		141002BLS●	71.45	Black Stainless	6			
		141002BG	64.95	Brushed Gold	6			
OPTIONAL AC ADAPTERS SOLD SEPARATELY								
		169031	156.45	N/A or Unfinished	12			
OPTIONAL WALL MOUNT & HOSE EXTENSION KIT SOLD SEPARATELY								
		199785	58.60	N/A or Unfinished	6			
								



Kitchen Faucets

	MODEL	LIST	FINISH/CONNECT	CASE QTY
ALIGN® TOUCHLESS WITH MOTIONSENSE™ WAVE ONE-HANDLE SPRING KITCHEN PULLDOWN				
 <p>DECKPLATE SOLD SEPARATELY</p> 	<ul style="list-style-type: none"> • application: one or three hole • spout height: 21.75" • connection: 3/8" compression • number of functions: two-function • spray type: aerated stream; powerful cleaning rinse • handle mounting: right only • hose length: 68" • DC powered: 6 AA cell batteries included 	1.5 GPM (5.7 L/min) max.		
	<ul style="list-style-type: none"> 5923EWC 794.75 Chrome 3 5923EWSRS● 993.40 Spot Resist Stainless 3 5923EWBL 1033.15 Matte Black 3 5923EWBLS● 1152.35 Black Stainless 3 5923EWBG 1152.35 Brushed Gold 3 	OPTIONAL DECKPLATE SOLD SEPARATELY		
	<ul style="list-style-type: none"> 141002 56.60 Chrome 6 141002SRS● 64.95 Spot Resist Stainless 6 141002BL 64.95 Matte Black 6 141002BLS● 71.45 Black Stainless 6 141002BG 64.95 Brushed Gold 6 	OPTIONAL AC ADAPTERS SOLD SEPARATELY		
	<ul style="list-style-type: none"> 169031 156.45 N/A or Unfinished 12 	OPTIONAL WALL MOUNT & HOSE EXTENSION KIT SOLD SEPARATELY		
	<ul style="list-style-type: none"> 177566 48.10 N/A or Unfinished 6 	 POWER CLEAN DURALOCK® DURALAST® 		

	MODEL	LIST	FINISH/CONNECT	CASE QTY
ALIGN® TOUCHLESS WITH MOTIONSENSE™ WAVE ONE-HANDLE KITCHEN PULLDOWN				
 <p>DECKPLATE SOLD SEPARATELY</p> 	<ul style="list-style-type: none"> • application: one or three hole • spout height: 15.70" • connection: 3/8" compression • number of functions: two-function • spray type: aerated stream; powerful cleaning rinse • handle mounting: right only • hose length: 68" • DC powered: 6 AA cell batteries included 	1.5 GPM (5.7 L/min) max.		
	<ul style="list-style-type: none"> 7565EWC 727.60 Chrome 3 7565EWSRS● 909.50 Spot Resist Stainless 3 7565EWBL 945.85 Matte Black 3 7565EWBLS● 1055.00 Black Stainless 3 7565EWBG 1055.00 Brushed Gold 3 	OPTIONAL DECKPLATE SOLD SEPARATELY		
	<ul style="list-style-type: none"> 141002 56.60 Chrome 6 141002SRS● 64.95 Spot Resist Stainless 6 141002BL 64.95 Matte Black 6 141002BLS● 71.45 Black Stainless 6 141002BG 64.95 Brushed Gold 6 	OPTIONAL AC ADAPTERS SOLD SEPARATELY		
	<ul style="list-style-type: none"> 169031 156.45 N/A or Unfinished 12 	OPTIONAL WALL MOUNT & HOSE EXTENSION KIT SOLD SEPARATELY		
	<ul style="list-style-type: none"> 177566 48.10 N/A or Unfinished 6 	 POWER CLEAN reflex™ DURALOCK® DURALAST®		

	MODEL	LIST	FINISH/CONNECT	CASE QTY
ALIGN® ONE-HANDLE KITCHEN SPRING PULLDOWN				
 <p>DECKPLATE SOLD SEPARATELY</p> 	<ul style="list-style-type: none"> • application: one or three hole • spout height: 21.75" • connection: 3/8" compression • number of functions: four-function • spray type: aerated stream; powerful cleaning rinse; boosted rinse; boosted stream • handle mounting: right only • hose length: 68" 	1.5 GPM (5.7 L/min) max.		
	<ul style="list-style-type: none"> 5923 635.75 Chrome 3 5923SRS● 794.65 Spot Resist Stainless 3 5923BL 826.45 Matte Black 3 5923BLS● 921.80 Black Stainless 3 5923BG 921.80 Brushed Gold 3 	OPTIONAL DECKPLATE SOLD SEPARATELY		
	<ul style="list-style-type: none"> 141002 56.60 Chrome 6 141002SRS● 64.95 Spot Resist Stainless 6 141002BL 64.95 Matte Black 6 141002BLS● 71.45 Black Stainless 6 141002BG 64.95 Brushed Gold 6 	OPTIONAL AC ADAPTERS SOLD SEPARATELY		
	<ul style="list-style-type: none"> 169031 156.45 N/A or Unfinished 12 	OPTIONAL WALL MOUNT & HOSE EXTENSION KIT SOLD SEPARATELY		
	<ul style="list-style-type: none"> 177566 48.10 N/A or Unfinished 6 	 POWERBOOST DURALOCK® DURALAST® 		

KITCHEN

Kitchen Faucets

KITCHEN

ALIGN®		3-IN-1 WATER FILTRATION PULLDOWN KITCHEN FAUCET	MODEL	LIST	FINISH/CONNECT	CASE QTY
 <p>DECKPLATE SOLD SEPARATELY</p> <p>NEW! Q3</p>	<ul style="list-style-type: none"> • water filtration at the spray wand • spray wand: metal • application: one hole • spout height: 15.63" • connection: 3/8" compression • number of functions: three-function • spray type: filtered laminar stream; unfiltered aerated stream; unfiltered PowerClean spray • handle mounting: right only • hose length: 68" 	1.5 GPM (5.7 L/min) max.				
		F5923	763.90	Chrome	3	
		F5923SRS●	954.85	Spot Resist Stainless	3	
		F5923BL	993.05	Matte Black	3	
		F5923BG	1107.65	Brushed Gold	3	
OPTIONAL DECKPLATE SOLD SEPARATELY						
		141002	56.60	Chrome	6	
		141002SRS●	64.95	Spot Resist Stainless	6	
		141002BL	64.95	Matte Black	6	
		141002BG	64.95	Brushed Gold	6	

 DURALOCK® DURALAST® 

ALIGN®		ONE-HANDLE KITCHEN PULLDOWN	MODEL	LIST	FINISH/CONNECT	CASE QTY
 <p>DECKPLATE SOLD SEPARATELY</p>	<ul style="list-style-type: none"> • application: one or three hole • spout height: 15.70" • connection: 3/8" compression • number of functions: four-function • spray type: aerated stream; powerful cleaning rinse; boosted rinse; boosted stream • handle mounting: right only • hose length: 68" 	1.5 GPM (5.7 L/min) max.				
		7565	563.00	Chrome	3	
		7565SRS●	703.70	Spot Resist Stainless	3	
		7565BL	731.85	Matte Black	3	
		7565BLS●	816.30	Black Stainless	3	
7565BG	816.30	Brushed Gold	3			
OPTIONAL DECKPLATE SOLD SEPARATELY						
		141002	56.60	Chrome	6	
		141002SRS●	64.95	Spot Resist Stainless	6	
		141002BL	64.95	Matte Black	6	
		141002BLS●	71.45	Black Stainless	6	
		141002BG	64.95	Brushed Gold	6	

 POWERBOOST reflex  DURALOCK® DURALAST®



ALIGN®		ONE-HANDLE KITCHEN	MODEL	LIST	FINISH/CONNECT	CASE QTY
 <p>DECKPLATE SOLD SEPARATELY</p>	<ul style="list-style-type: none"> • application: two or four hole • spout height: 15.31" • connection: 3/8" compression • spray type: aerated stream • handle mounting: right only • side spray: included 	1.5 GPM (5.7 L/min) max.				
		7165	522.25	Chrome	3	
		7165SRS●	652.80	Spot Resist Stainless	3	
		7165BL	678.90	Matte Black	3	
		OPTIONAL DECKPLATE SOLD SEPARATELY				
		141002	56.60	Chrome	6	
		141002SRS●	64.95	Spot Resist Stainless	6	
		141002BL	64.95	Matte Black	6	



 DURALOCK® DURALAST®



ALIGN®		ONE-HANDLE KITCHEN	MODEL	LIST	FINISH/CONNECT	CASE QTY
 <p>DECKPLATE SOLD SEPARATELY</p>	<ul style="list-style-type: none"> • application: one or three hole • spout height: 15.31" • connection: 3/8" compression • spray type: aerated stream • handle mounting: right only 	1.5 GPM (5.7 L/min) max.				
		7365	459.50	Chrome	3	
		7365SRS●	574.40	Spot Resist Stainless	3	
		7365BL	597.35	Matte Black	3	
		OPTIONAL DECKPLATE SOLD SEPARATELY				
		141002	56.60	Chrome	6	
		141002SRS●	64.95	Spot Resist Stainless	6	
		141002BL	64.95	Matte Black	6	

 DURALAST®

Kitchen Faucets



	MODEL	LIST	FINISH/CONNECT	CASE QTY	
KURV™ SMART FAUCET ONE-HANDLE KITCHEN PULLDOWN					
 <p>DECKPLATE SOLD SEPARATELY</p> <ul style="list-style-type: none"> • spray wand: metal • application: one or three hole • spout height: 16.38" • connection: 3/8" compression • number of functions: four-function • spray type: aerated stream; powerful cleaning rinse; boosted rinse; boosted stream • handle mounting: right only • hose length: 68" • DC powered: 6 D-cell batteries included • voice activated kitchen: compatible with Amazon Just Ask Alexa and Works with Google Assistant 	1.5 GPM (5.7 L/min) max.				
	9126EVC	871.40	Chrome	3	
	9126EVSRS●	958.55	Spot Resist Stainless	3	
	9126EVB�	1002.10	Matte Black	3	
	9126EVNL	1045.65	Polished Nickel	3	
	OPTIONAL DECKPLATE SOLD SEPARATELY				
	141002	56.60	Chrome	6	
	141002SRS●	64.95	Spot Resist Stainless	6	
	141002BL	64.95	Matte Black	6	
	141002NL	61.60	Polished Nickel	6	
	OPTIONAL AC ADAPTERS SOLD SEPARATELY				
	169031	156.45	N/A or Unfinished	12	
	OPTIONAL WALL MOUNT & HOSE EXTENSION KIT SOLD SEPARATELY				
	199785	58.60	N/A or Unfinished	6	
	 POWERBOOST reflex DURALOCK® DURALAST®				



	MODEL	LIST	FINISH/CONNECT	CASE QTY	
KURV™ TOUCHLESS WITH MOTIONSENSE™ WAVE ONE-HANDLE KITCHEN PULLDOWN					
 <p>DECKPLATE SOLD SEPARATELY</p> <ul style="list-style-type: none"> • spray wand: metal • application: one or three hole • spout height: 16.38" • connection: 3/8" compression • number of functions: two-function • spray type: aerated stream; powerful cleaning rinse • handle mounting: right only • hose length: 68" • DC powered: 6 AA cell batteries included 	1.5 GPM (5.7 L/min) max.				
	9126EWC	710.15	Chrome	3	
	9126EWSRS●	887.70	Spot Resist Stainless	3	
	9126EWBL	923.20	Matte Black	3	
	9126EWNL	958.70	Polished Nickel	3	
	OPTIONAL DECKPLATE SOLD SEPARATELY				
	141002	56.60	Chrome	6	
	141002SRS●	64.95	Spot Resist Stainless	6	
	141002BL	64.95	Matte Black	6	
	141002NL	61.60	Polished Nickel	6	
	OPTIONAL AC ADAPTERS SOLD SEPARATELY				
	169031	156.45	N/A or Unfinished	12	
	OPTIONAL WALL MOUNT & HOSE EXTENSION KIT SOLD SEPARATELY				
	177566	48.10	N/A or Unfinished	6	
	 POWER CLEAN reflex DURALOCK® DURALAST®				



	MODEL	LIST	FINISH/CONNECT	CASE QTY	
KURV™ 3-IN-1 WATER FILTRATION PULLDOWN KITCHEN FAUCET					
 <p>DECKPLATE SOLD SEPARATELY</p> <p>NEW! Q3</p> <ul style="list-style-type: none"> • water filtration at the spray wand • spray wand: metal • application: one hole • spout height: 16.38" • connection: 3/8" compression • number of functions: three-function • spray type: filtered laminar stream; unfiltered aerated stream; unfiltered PowerClean spray • handle mounting: right only • hose length: 68" 	1.5 GPM (5.7 L/min) max.				
	F9126	657.30	Chrome	3	
	F9126SRS●	821.65	Spot Resist Stainless	3	
	F9126BL	854.50	Matte Black	3	
	OPTIONAL DECKPLATE SOLD SEPARATELY				
	141002	56.60	Chrome	6	
	141002SRS●	64.95	Spot Resist Stainless	6	
	141002BL	64.95	Matte Black	6	
	 reflex DURALOCK® DURALAST®				



KITCHEN

Kitchen Faucets













	MODEL	LIST	FINISH/CONNECT	CASE QTY
KURV™ ONE-HANDLE KITCHEN PULLDOWN				
 DECKPLATE SOLD SEPARATELY 	<ul style="list-style-type: none"> • spray wand metal • application: one or three hole • spout height: 16.38" • connection: 3/8" compression • number of functions: four-function • spray type: aerated stream; powerful cleaning rinse; boosted rinse; boosted stream • handle mounting: right only • hose length: 68" 			
	1.5 GPM (5.7 L/min) max. 9126 548.90 Chrome 3 9126SRS● 686.10 Spot Resist Stainless 3 9126BL 713.55 Matte Black 3 9126NL 741.00 Polished Nickel 3			
OPTIONAL DECKPLATE SOLD SEPARATELY				
141002 56.60 Chrome 6 141002SRS● 64.95 Spot Resist Stainless 6 141002BL 64.95 Matte Black 6 141002NL 61.60 Polished Nickel 6				
 POWERBOOST reflex DURALOCK® DURALAST®				

	MODEL	LIST	FINISH/CONNECT	CASE QTY
BRANTFORD® SMART FAUCET ONE-HANDLE KITCHEN PULLDOWN				
 DECKPLATE INCLUDED 	<ul style="list-style-type: none"> • application: one or three hole • spout height: 15.50" • connection: 3/4" compression • number of functions: four-function • spray type: aerated stream; powerful cleaning rinse; boosted rinse; boosted stream • handle mounting: right only • hose length: 68" • deckplate: included • DC powered: 6 D-cell batteries included • voice activated kitchen: compatible with Amazon Just Ask Alexa and Works with Google Assistant 			
	1.5 GPM (5.7 L/min) max. 7185EVC 811.10 Chrome 3 7185EVSRS● 892.20 Spot Resist Stainless 3 7185EVORB 973.35 Oil Rubbed Bronze 3			
OPTIONAL AC ADAPTERS SOLD SEPARATELY				
169031 156.45 N/A or Unfinished 12				
OPTIONAL WALL MOUNT & HOSE EXTENSION KIT SOLD SEPARATELY				
199785 58.60 N/A or Unfinished 6				
 POWERBOOST reflex DURALOCK® DURALAST®				

	MODEL	LIST	FINISH/CONNECT	CASE QTY
BRANTFORD® TOUCHLESS WITH MOTIONSENSE™ WAVE ONE-HANDLE KITCHEN PULLDOWN				
 DECKPLATE INCLUDED 	<ul style="list-style-type: none"> • application: one or three hole • spout height: 15.50" • connection: 3/8" compression • number of functions: two-function • spray type: powerful cleaning rinse; aerated stream • handle mounting: right only • hose length: 68" • deckplate: included • DC powered: 6 AA cell batteries: included 			
	1.5 GPM (5.7 L/min) max. 7185EWC 641.05 Chrome 3 7185EWSRS● 801.30 Spot Resist Stainless 3 7185EWORB 897.45 Oil Rubbed Bronze 3			
OPTIONAL AC ADAPTERS SOLD SEPARATELY				
169031 156.45 N/A or Unfinished 12				
OPTIONAL WALL MOUNT & HOSE EXTENSION KIT SOLD SEPARATELY				
177566 48.10 N/A or Unfinished 6				
 POWER CLEAN reflex DURALOCK® DURALAST®				

	MODEL	LIST	FINISH/CONNECT	CASE QTY
BRANTFORD® ONE-HANDLE KITCHEN PULLDOWN				
 DECKPLATE INCLUDED 	<ul style="list-style-type: none"> • application: one or three hole • spout height: 15.50" • connection: 3/8" compression • number of functions: four-function • spray type: aerated stream; powerful cleaning rinse; boosted rinse; boosted stream • handle mounting: right only • hose length: 68" • deckplate: included 			
	1.5 GPM (5.7 L/min) max. 7185C 484.75 Chrome 3 7185SRS● 605.90 Spot Resist Stainless 3 7185ORB 678.65 Oil Rubbed Bronze 3			
 POWERBOOST reflex DURALOCK® DURALAST®				

Kitchen Faucets



	MODEL	LIST	FINISH/CONNECT	CASE QTY
BRANTFORD® ONE-HANDLE KITCHEN PULLOUT				
 DECKPLATE INCLUDED 	<ul style="list-style-type: none"> • application: one or three hole • spout height: 12.94" • connection: 3/8" compression • number of functions: two-function • spray type: aerated stream; powerful cleaning rinse • hose length: 68" • deckplate: included 	1.5 GPM (5.7 L/min) max.		
	7295SRS●	549.85	Spot Resist Stainless	3
 POWER CLEAN reflex DURALOCK® DURALAST®				
ARBOR® SMART FAUCET ONE-HANDLE KITCHEN PULLDOWN				
 DECKPLATE INCLUDED 	<ul style="list-style-type: none"> • application: one or three hole • spout height: 15.50" • connection: 3/8" compression • number of functions: four-function • spray type: aerated stream; powerful cleaning rinse; boosted rinse; boosted stream • handle mounting: right only • hose length: 68" • deckplate: included • DC powered: 6 D-cell batteries included • voice activated kitchen: compatible with Amazon Just Ask Alexa and Works with Google Assistant 	1.5 GPM (5.7 L/min) max.		
	7594EVC	788.60	Chrome	3
	7594EVSRS●	867.45	Spot Resist Stainless	3
	7594EVBL	906.90	Matte Black	3
	7594EVORB	946.30	Oil Rubbed Bronze	3
OPTIONAL AC ADAPTERS SOLD SEPARATELY				
	169031	156.45	N/A or Unfinished	12
OPTIONAL WALL MOUNT & HOSE EXTENSION KIT SOLD SEPARATELY				
	199785	58.60	N/A or Unfinished	6
 POWERBOOST reflex DURALOCK® DURALAST®				
ARBOR® TOUCHLESS WITH MOTIONSENSE™ WAVE ONE-HANDLE KITCHEN PULLDOWN				
 DECKPLATE INCLUDED 	<ul style="list-style-type: none"> • application: one or three hole • spout height: 15.50" • connection: 3/8" compression • number of functions: two-function • spray type: powerful cleaning rinse; aerated stream • handle mounting: right only • hose length: 68" • deckplate: included • DC powered: 6 AA cell batteries: included 	1.5 GPM (5.7 L/min) max.		
	7594EWC	618.90	Chrome	3
	7594EWSRS●	773.60	Spot Resist Stainless	3
	7594EWBL	804.55	Matte Black	3
	7594EWORB	866.45	Oil Rubbed Bronze	3
OPTIONAL AC ADAPTERS SOLD SEPARATELY				
	169031	156.45	N/A or Unfinished	12
OPTIONAL WALL MOUNT & HOSE EXTENSION KIT SOLD SEPARATELY				
	177566	48.10	N/A or Unfinished	6
 motion sense POWER CLEAN reflex DURALOCK® DURALAST®				
ARBOR® ONE-HANDLE KITCHEN PULLDOWN				
 DECKPLATE INCLUDED 	<ul style="list-style-type: none"> • application: one or three hole • spout height: 15.50" • connection: 3/8" compression • number of functions: four-function • spray type: aerated stream; powerful cleaning rinse; boosted rinse; boosted stream • handle mounting: right only • hose length: 68" • deckplate: included 	1.5 GPM (5.7 L/min) max.		
	7594C	462.60	Chrome	3
	7594SRS●	578.25	Spot Resist Stainless	3
	7594BL	601.35	Matte Black	3
	7594ORB	647.65	Oil Rubbed Bronze	3
 POWERBOOST reflex DURALOCK® DURALAST®				



KITCHEN









Kitchen Faucets

KITCHEN

BELFIELD™		SMART FAUCET ONE-HANDLE KITCHEN PULLDOWN			
 <p>DECKPLATE INCLUDED</p> 	<ul style="list-style-type: none"> • application: one or three hole • spout height: 15.62" • connection: 3/8" compression • number of functions: four-function • spray type: aerated stream; powerful cleaning rinse; boosted rinse; boosted stream • handle mounting: right only • hose length: 68" • deckplate: included • DC powered: 6 D-cell batteries included • voice activated kitchen: compatible with Amazon Just Ask Alexa and Works with Google Assistant 	1.5 GPM (5.7 L/min) max.			
		7260EVC	776.75	Chrome	3
		7260EVSRS●	854.45	Spot Resist Stainless	3
		7260EVBL	893.25	Matte Black	3
		7260EVORB	932.10	Oil Rubbed Bronze	3
OPTIONAL AC ADAPTERS SOLD SEPARATELY					
		169031	156.45	N/A or Unfinished	12
OPTIONAL WALL MOUNT & HOSE EXTENSION KIT SOLD SEPARATELY					
		199785	58.60	N/A or Unfinished	6
 POWERBOOST reflex DURALOCK® DURALAST®					

BELFIELD™		TOUCHLESS WITH MOTIONSENSE™ WAVE ONE-HANDLE KITCHEN PULLDOWN			
 <p>DECKPLATE INCLUDED</p> 	<ul style="list-style-type: none"> • application: one or three hole • spout height: 15.62" • connection: 3/8" compression • number of functions: two-function • spray type: aerated stream; powerful cleaning rinse • handle mounting: right only • hose length: 68" • deckplate: included • DC powered: 6 AA cell batteries: included 	1.5 GPM (5.7 L/min) max.			
		7260EWC	607.30	Chrome	3
		7260EWSRS●	759.10	Spot Resist Stainless	3
		7260EWBL	789.45	Matte Black	3
		7260EWORB	850.20	Oil Rubbed Bronze	3
OPTIONAL AC ADAPTERS SOLD SEPARATELY					
		169031	156.45	N/A or Unfinished	12
OPTIONAL WALL MOUNT & HOSE EXTENSION KIT SOLD SEPARATELY					
		177566	48.10	N/A or Unfinished	6
 motionSense POWER CLEAN reflex DURALOCK® DURALAST®					



BELFIELD™		ONE-HANDLE KITCHEN SPRING PULLDOWN			
 	<ul style="list-style-type: none"> • application: one or three hole • spout height: 17.26" • connection: 3/8" compression • number of functions: four-function • spray type: aerated stream; powerful cleaning rinse; boosted rinse; boosted stream • handle mounting: right only • hose length: 68" • deck plate: included 	1.5 GPM (5.7 L/min) max.			
		5927	531.70	Chrome	3
		5927SRS●	664.60	Spot Resist Stainless	3
		5927BL	691.20	Matte Black	3
		5927ORB	744.35	Oil Rubbed Bronze	3
 POWERBOOST DURALOCK® DURALAST® (3x)					





BELFIELD™		ONE-HANDLE KITCHEN PULLDOWN			
 <p>DECKPLATE INCLUDED</p> 	<ul style="list-style-type: none"> • application: one or three hole • spout height: 15.62" • connection: 3/8" compression • number of functions: four-function • spray type: aerated stream; powerful cleaning rinse; boosted rinse; boosted stream • handle mounting: right only • hose length: 68" • deckplate: included 	1.5 GPM (5.7 L/min) max.			
		7260	451.00	Chrome	3
		7260SRS●	563.70	Spot Resist Stainless	3
		7260BL	586.25	Matte Black	3
		7260ORB	631.35	Oil Rubbed Bronze	3
 POWERBOOST reflex DURALOCK® DURALAST®					









Kitchen Faucets

KITCHEN



BELFIELD™		ONE-HANDLE KITCHEN																	
 <p>DECKPLATE INCLUDED</p> 	<ul style="list-style-type: none"> • application: two or four hole • spout height: 12.22" • connection: 3/8" compression • spray type: aerated stream • deckplate: included • side spray: included 	<p>1.5 GPM (5.7 L/min) max.</p> <table border="1"> <tr> <td>7245C</td> <td>391.60</td> <td>Chrome</td> <td>3</td> </tr> <tr> <td>7245SRS●</td> <td>489.50</td> <td>Spot Resist Stainless</td> <td>3</td> </tr> <tr> <td>7245BL</td> <td>509.05</td> <td>Matte Black</td> <td>3</td> </tr> <tr> <td>7245ORB</td> <td>548.20</td> <td>Oil Rubbed Bronze</td> <td>3</td> </tr> </table>	7245C	391.60	Chrome	3	7245SRS●	489.50	Spot Resist Stainless	3	7245BL	509.05	Matte Black	3	7245ORB	548.20	Oil Rubbed Bronze	3	
	7245C	391.60	Chrome	3															
7245SRS●	489.50	Spot Resist Stainless	3																
7245BL	509.05	Matte Black	3																
7245ORB	548.20	Oil Rubbed Bronze	3																
																			



BELFIELD™		TWO-HANDLE KITCHEN																	
	<ul style="list-style-type: none"> • application: four hole • spout height: 9.34" • connection: 1/2" IPS • spray type: aerated stream • deckplate: included • side spray: included 	<p>1.5 GPM (5.7 L/min) max.</p> <table border="1"> <tr> <td>7255C</td> <td>370.10</td> <td>Chrome</td> <td>3</td> </tr> <tr> <td>7255SRS●</td> <td>462.65</td> <td>Spot Resist Stainless</td> <td>3</td> </tr> <tr> <td>7255BL</td> <td>481.15</td> <td>Matte Black</td> <td>3</td> </tr> <tr> <td>7255ORB</td> <td>518.15</td> <td>Oil Rubbed Bronze</td> <td>3</td> </tr> </table>	7255C	370.10	Chrome	3	7255SRS●	462.65	Spot Resist Stainless	3	7255BL	481.15	Matte Black	3	7255ORB	518.15	Oil Rubbed Bronze	3	
	7255C	370.10	Chrome	3															
7255SRS●	462.65	Spot Resist Stainless	3																
7255BL	481.15	Matte Black	3																
7255ORB	518.15	Oil Rubbed Bronze	3																
																			
	<ul style="list-style-type: none"> • application: three hole • spout height: 9.34" • connection: 1/2" IPS • spray type: aerated stream • deckplate: included 	<p>1.5 GPM (5.7 L/min) max.</p> <table border="1"> <tr> <td>7250C</td> <td>318.40</td> <td>Chrome</td> <td>3</td> </tr> <tr> <td>7250SRS●</td> <td>398.00</td> <td>Spot Resist Stainless</td> <td>3</td> </tr> <tr> <td>7250BL</td> <td>413.90</td> <td>Matte Black</td> <td>3</td> </tr> <tr> <td>7250ORB</td> <td>445.75</td> <td>Oil Rubbed Bronze</td> <td>3</td> </tr> </table>	7250C	318.40	Chrome	3	7250SRS●	398.00	Spot Resist Stainless	3	7250BL	413.90	Matte Black	3	7250ORB	445.75	Oil Rubbed Bronze	3	
	7250C	318.40	Chrome	3															
7250SRS●	398.00	Spot Resist Stainless	3																
7250BL	413.90	Matte Black	3																
7250ORB	445.75	Oil Rubbed Bronze	3																
																			



GENTA™ LX		TOUCHLESS WITH MOTIONSENSE™ WAVE ONE-HANDLE KITCHEN PULLDOWN													
 <p>DECKPLATE INCLUDED</p> 	<ul style="list-style-type: none"> • application: one or three hole • spout height: 16.00" • connection: 3/8" compression • number of functions: two-function • spray type: aerated stream; powerful cleaning rinse • handle mounting: right only • hose length: 68" • deckplate: included • DC powered: 6 AA cell batteries: included 	<p>1.5 GPM (5.7 L/min) max.</p> <table border="1"> <tr> <td>7882EWC</td> <td>605.75</td> <td>Chrome</td> <td>3</td> </tr> <tr> <td>7882EWSRS●</td> <td>757.20</td> <td>Spot Resist Stainless</td> <td>3</td> </tr> <tr> <td>7882EWBL</td> <td>787.50</td> <td>Matte Black</td> <td>3</td> </tr> </table>	7882EWC	605.75	Chrome	3	7882EWSRS●	757.20	Spot Resist Stainless	3	7882EWBL	787.50	Matte Black	3	
	7882EWC	605.75	Chrome	3											
7882EWSRS●	757.20	Spot Resist Stainless	3												
7882EWBL	787.50	Matte Black	3												
		OPTIONAL AC ADAPTERS SOLD SEPARATELY													
		169031	156.45 N/A or Unfinished 12												
		OPTIONAL WALL MOUNT & HOSE EXTENSION KIT SOLD SEPARATELY													
		177566	48.10 N/A or Unfinished 6												
															



GENTA™ LX		ONE-HANDLE KITCHEN SPRING PULLDOWN													
 	<ul style="list-style-type: none"> • application: one or three hole • spout height: 16.125" • connection: 3/8" compression • number of functions: four-function • spray type: aerated stream; powerful cleaning rinse; boosted rinse; boosted stream • handle mounting: right only • hose length: 68" • deck plate included 	<p>1.5 GPM (5.7 L/min) max.</p> <table border="1"> <tr> <td>5926</td> <td>529.90</td> <td>Chrome</td> <td>3</td> </tr> <tr> <td>5926SRS●</td> <td>662.40</td> <td>Spot Resist Stainless</td> <td>3</td> </tr> <tr> <td>5926BL</td> <td>688.90</td> <td>Matte Black</td> <td>3</td> </tr> </table>	5926	529.90	Chrome	3	5926SRS●	662.40	Spot Resist Stainless	3	5926BL	688.90	Matte Black	3	
	5926	529.90	Chrome	3											
5926SRS●	662.40	Spot Resist Stainless	3												
5926BL	688.90	Matte Black	3												
															

Kitchen Faucets













		MODEL	LIST	FINISH/CONNECT	CASE QTY
GENTA™ LX		ONE-HANDLE KITCHEN PULLDOWN			
 DECKPLATE INCLUDED 	<ul style="list-style-type: none"> • application: one or three hole • spout height: 16.00" • connection: 3/8" compression • number of functions: four-function • pray type: aerated stream; powerful cleaning rinse; boosted rinse; boosted stream • handle mounting: right only • hose length: 68" • deckplate: included 	1.5 GPM (5.7 L/min) max.			
	<ul style="list-style-type: none"> • application: one or three hole • spout height: 16.00" • connection: 3/8" compression • number of functions: four-function • pray type: aerated stream; powerful cleaning rinse; boosted rinse; boosted stream • handle mounting: right only • hose length: 68" • deckplate: included 	7882	449.45	Chrome	3
		7882SRS●	561.85	Spot Resist Stainless	3
		7882BL	584.30	Matte Black	3
 POWERBOOST reflex DURALOCK® DURALAST®					

		MODEL	LIST	FINISH/CONNECT	CASE QTY
SLEEK®		SMART FAUCET ONE-HANDLE KITCHEN PULLDOWN			
 DECKPLATE INCLUDED 	<ul style="list-style-type: none"> • application: one or three hole • spout height: 15.56" • connection: 3/8" compression • number of functions: four-function • spray type: aerated stream; powerful cleaning rinse; boosted rinse; boosted stream • handle mounting: right only • hose length: 68" • deckplate: included • DC powered: 6 D-cell batteries included • voice activated kitchen: compatible with Amazon Just Ask Alexa and Works with Google Assistant 	1.5 GPM (5.7 L/min) max.			
		7864EVC	736.35	Chrome	3
	7864EVSRS●	809.95	Spot Resist Stainless	3	
	7864EVBL	846.80	Matte Black	3	
	7864EVBLS●	883.60	Black Stainless	3	
	7864EVBG	883.60	Brushed Gold	3	
OPTIONAL AC ADAPTERS SOLD SEPARATELY					
	169031	156.45	N/A or Unfinished	12	
OPTIONAL WALL MOUNT & HOSE EXTENSION KIT SOLD SEPARATELY					
	199785	58.60	N/A or Unfinished	6	
 POWERBOOST reflex DURALOCK® DURALAST®					

		MODEL	LIST	FINISH/CONNECT	CASE QTY
SLEEK®		TOUCHLESS WITH MOTIONSENSE™ WAVE ONE-HANDLE SPRING KITCHEN PULLDOWN			
 DECKPLATE INCLUDED 	<ul style="list-style-type: none"> • application: one or three hole • spout height: 23.25" • connection: 3/8" compression • number of functions: two-function • spray type: aerated stream; powerful cleaning rinse • handle mounting: right only • hose length: 68" • deckplate: included • DC powered: 6 AA cell batteries included 	1.5 GPM (5.7 L/min) max.			
	<ul style="list-style-type: none"> • application: one or three hole • spout height: 23.25" • connection: 3/8" compression • number of functions: two-function • spray type: aerated stream; powerful cleaning rinse • handle mounting: right only • hose length: 68" • deckplate: included • DC powered: 6 AA cell batteries included 	5925EWC	653.50	Chrome	3
	5925EWSRS●	816.80	Spot Resist Stainless	3	
	5925EWBL	849.50	Matte Black	3	
	5925EWBLS	947.50	Black Stainless	3	
OPTIONAL AC ADAPTERS SOLD SEPARATELY					
	169031	156.45	N/A or Unfinished	12	
OPTIONAL WALL MOUNT & HOSE EXTENSION KIT SOLD SEPARATELY					
	177566	48.10	N/A or Unfinished	6	
 motionSense POWER CLEAN DURALOCK® DURALAST® 3x					

		MODEL	LIST	FINISH/CONNECT	CASE QTY
SLEEK®		TOUCHLESS WITH MOTIONSENSE™ WAVE ONE-HANDLE KITCHEN PULLDOWN			
 DECKPLATE INCLUDED 	<ul style="list-style-type: none"> • application: one or three hole • spout height: 15.56" • connection: 3/8" compression • number of functions: two-function • spray type: aerated stream; powerful cleaning rinse • handle mounting: right only • hose length: 68" • deckplate: included • DC powered: 6 AA cell batteries: included 	1.5 GPM (5.7 L/min) max.			
		7864EWC	567.55	Chrome	3
	7864EWSRS●	709.40	Spot Resist Stainless	3	
	7864EWBL	737.80	Matte Black	3	
	7864EWBLS●	822.90	Black Stainless	3	
	7864EVBG	822.90	Brushed Gold	3	
OPTIONAL AC ADAPTERS SOLD SEPARATELY					
	169031	156.45	N/A or Unfinished	12	
OPTIONAL WALL MOUNT & HOSE EXTENSION KIT SOLD SEPARATELY					
	177566	48.10	N/A or Unfinished	6	
 motionSense POWER CLEAN reflex DURALOCK® DURALAST®					













Kitchen Faucets

	MODEL	LIST	FINISH/CONNECT	CASE QTY
SLEEK® ONE-HANDLE KITCHEN SPRING PULLDOWN				
 <p>DECKPLATE INCLUDED</p>	<ul style="list-style-type: none"> • application: one or three hole • spout height: 23.25" • connection: 3/8" compression • number of functions: four-function • spray type: aerated stream; powerful cleaning rinse; boosted rinse; boosted stream • handle mounting: right only • hose length: 68" • deckplate: included 	1.5 GPM (5.7 L/min) max.		
	5925	503.45	Chrome	3
	5925SRS●	629.30	Spot Resist Stainless	3
	5925BL	654.45	Matte Black	3
	5925BLS●	730.00	Black Stainless	3
 POWERBOOST DURALOCK® DURALAST® 				
SLEEK® ONE-HANDLE KITCHEN PULLDOWN				
	<ul style="list-style-type: none"> • application: two hole • spout height: 15.56" • connection: 3/8" compression • number of functions: four-function • spray type: aerated stream; powerful cleaning rinse; boosted rinse; boosted stream • handle mounting: right only • hose length: 68" 	1.5 GPM (5.7 L/min) max.		
	7871	452.40	Chrome	3
	7871SRS●	565.50	Spot Resist Stainless	3
	7871BL	588.10	Matte Black	3
 POWERBOOST reflex  DURALOCK® DURALAST®				
SLEEK® ONE-HANDLE KITCHEN PULLDOWN				
 <p>DECKPLATE INCLUDED</p>	<ul style="list-style-type: none"> • application: one or three hole • spout height: 15.56" • connection: 3/8" compression • number of functions: four-function • spray type: aerated stream; powerful cleaning rinse; boosted rinse; boosted stream • handle mounting: right only • hose length: 68" • deckplate: included 	1.5 GPM (5.7 L/min) max.		
	7864	411.25	Chrome	3
	7864SRS●	514.05	Spot Resist Stainless	3
	7864BL	534.60	Matte Black	3
	7864ORB	575.70	Oil Rubbed Bronze	3
	7864BLS●	596.30	Black Stainless	3
	7864BG	596.30	Brushed Gold	3
 POWERBOOST reflex  DURALOCK® DURALAST®				
CAMERIST® ONE-HANDLE KITCHEN PULLOUT				
 <p>DECKPLATE INCLUDED</p>	<ul style="list-style-type: none"> • application: one or three hole • spout height: 12.00" • connection: 3/8" compression • number of functions: two-function • spray type: aerated stream; powerful cleaning rinse • hose length: 68" • deckplate: included 	1.5 GPM (5.7 L/min) max.		
	7545C◆	439.90	Chrome	3
	7545SRS●	549.85	Spot Resist Stainless	3
	7545ORB	615.85	Oil Rubbed Bronze	3
 POWER CLEAN reflex  DURALOCK® DURALAST®				















KITCHEN

Kitchen Faucets

KITCHEN

		MODEL	LIST	FINISH/CONNECT	CASE QTY
CAMERIST® ONE-HANDLE KITCHEN					
	DECKPLATE INCLUDED	<ul style="list-style-type: none"> • application: two or four hole • spout height: 8.13" • connection: 3/8" compression • spray type: aerated stream • deckplate: included • side spray: included 	1.5 GPM (5.7 L/min) max.		
		7840◆	269.70	Chrome	3
		7840SRS●	337.15	Spot Resist Stainless	3
		 DURALOCK® DURALAST®			
ONE-HANDLE KITCHEN					
	DECKPLATE INCLUDED	<ul style="list-style-type: none"> • application: one or three hole • spout height: 8.13" • connection: 3/8" compression • spray type: aerated stream • deckplate: included 	1.5 GPM (5.7 L/min) max.		
		7825	226.20	Chrome	3
		7825SRS●	282.75	Spot Resist Stainless	3
		 DURALAST®			
INTEGRA® ONE-HANDLE KITCHEN PULLOUT					
	DECKPLATE INCLUDED	<ul style="list-style-type: none"> • application: one or three hole • spout height: 10.63" • connection: 3/8" compression • number of functions: two-function • spray type: aerated stream; powerful cleaning rinse • hose length: 59" • deckplate: included 	1.5 GPM (5.7 L/min) max.		
		67315C	313.00	Chrome	6
		67315SRS●	391.30	Spot Resist Stainless	6
		 POWER CLEAN® DURALOCK® DURALAST®			
METHOD™ ONE-HANDLE KITCHEN PULLOUT					
	DECKPLATE INCLUDED	<ul style="list-style-type: none"> • application: one or three hole • spout height: 9.04" • connection: 3/8" compression • number of functions: two-function • spray type: aerated stream; powerful cleaning rinse • hose length: 68" • deckplate: included 	1.5 GPM (5.7 L/min) max.		
		7585C	257.65	Chrome	3
		7585SRS●	322.10	Spot Resist Stainless	3
		 POWER CLEAN® DURALOCK® DURALAST®			





Kitchen Faucets

		MODEL	LIST	FINISH/CONNECT	CASE QTY
CHATEAU® ONE-HANDLE KITCHEN					
 <ul style="list-style-type: none"> • application: four hole • spout height: 8.50" • connection: 3/8" compression • spray type: aerated stream • side spray: included 		1.5 GPM (5.7 L/min) max.			
		7430	218.50	Chrome	6
		7430SRS●	273.10	Spot Resist Stainless	6
	 DURALOCK® DURALAST®				
<hr/>					
 <ul style="list-style-type: none"> • application: two hole • spout height: 8.94" • connection: 3/8" compression • spray type: aerated stream • side spray: included 		1.5 GPM (5.7 L/min) max.			
		7437	223.20	Chrome	6
	 DURALOCK® DURALAST®				
<hr/>					
 <ul style="list-style-type: none"> • application: three hole • spout height: 8.50" • connection: 3/8" compression • spray type: aerated stream • side spray: included 		1.5 GPM (5.7 L/min) max.			
		7434	218.50	Chrome	6
	 DURALOCK® DURALAST®				
<hr/>					
 <ul style="list-style-type: none"> • application: three hole • spout height: 8.50" • connection: 3/8" compression • spray type: aerated stream 		1.5 GPM (5.7 L/min) max.			
		7425◆	173.65	Chrome	6
		7425SRS●	217.05	Spot Resist Stainless	6
	 DURALAST®				
<hr/>					
 <ul style="list-style-type: none"> • application: one hole • spout height: 8.94" • connection: 3/8" compression • spray type: aerated stream 		1.5 GPM (5.7 L/min) max.			
		7423	176.95	Chrome	6
	 DURALAST®				
<hr/>					
CHATEAU® TWO-HANDLE KITCHEN					
 <ul style="list-style-type: none"> • application: four hole • spout height: 6.50" • connection: 1/2" IPS • spray type: aerated stream • side spray: included 		1.5 GPM (5.7 L/min) max.			
		7907	207.40	Chrome	6
	 DURALOCK® DURALAST®				
<hr/>					
 <ul style="list-style-type: none"> • application: three hole • spout height: 6.50" • connection: 1/2" IPS • spray type: aerated stream 		1.5 GPM (5.7 L/min) max.			
		7906	164.85	Chrome	6
	 DURALAST®				

KITCHEN

Kitchen Faucets

KITCHEN

	MODEL	LIST	FINISH/CONNECT	CASE QTY
BANBURY® ONE-HANDLE KITCHEN				
 <ul style="list-style-type: none"> • application: four hole • spout height: 7.50" • connection: 3/8" compression • spray type: aerated stream • side spray: included <p> DURALOCK® DURALAST®</p>	1.5 GPM (5.7 L/min) max.			
	7051	142.80	Chrome	3
	7051SRS●	178.50	Spot Resist Stainless	3
 <ul style="list-style-type: none"> • application: three hole • spout height: 7.50" • connection: 3/8" compression • spray type: aerated stream <p> DURALAST®</p>	1.5 GPM (5.7 L/min) max.			
	7050	130.45	Chrome	3



Modern

Traditional

Premium Pot Fillers

The pot filler is the ultimate epicurean luxury, with all the details needed to ensure convenient flow control over a cooktop. They are available in traditional and modern styles to coordinate with any décor preference.



KITCHEN

	MODEL	LIST	FINISH/CONNECT	CASE QTY
MODERN POT FILLER	TWO-HANDLE KITCHEN POT FILLER - PREMIUM			
 <ul style="list-style-type: none"> • application: one hole • spout reach: 24.00" • connection: 1/2" IPS • spray type: aerated stream 	5.5 GPM (21 L/min) max.			
	S665	1109.60	Chrome	3
	S665SRS●	1387.05	Spot Resist Stainless	3
	S665BL	1442.50	Matte Black	3
	S665BLS●	1608.95	Black Stainless	3
	S665BG	1608.95	Brushed Gold	3

	MODEL	LIST	FINISH/CONNECT	CASE QTY
TRADITIONAL POT FILLER	TWO-HANDLE KITCHEN POT FILLER - PREMIUM			
 <ul style="list-style-type: none"> • application: one hole • spout reach: 24.00" • connection: 1/2" IPS • spray type: aerated stream 	5.5 GPM (21 L/min) max.			
	S664	1109.60	Chrome	3
	S664SRS●	1387.05	Spot Resist Stainless	3
	S664BL	1442.50	Matte Black	3
	S664NL	1498.00	Polished Nickel	3
	S664ORB	1553.45	Oil Rubbed Bronze	3
	S664BG	1608.95	Brushed Gold	3

Premium Bar/Prep Faucets

KITCHEN

Nio™

STō®

Weymouth®





Sinema™

Paterson™











Premium Bar/Prep Kitchen Faucets

Perfect for secondary sinks, bar/prep kitchen faucets combine design and functionality. Available in array of design options, Moen® bar/prep kitchen faucets match perfectly with almost any decorating style.



	MODEL	LIST	FINISH/CONNECT	CASE QTY
NIO™ ONE-HANDLE KITCHEN BAR - PREMIUM				
 	<ul style="list-style-type: none"> • application: one hole • spout height: 13.96" • connection: 3/8" compression • spray type: aerated stream • handle mounting: right only • secondary two-tone handle option included: chrome faucet has matte black handle; matte black faucet has brushed gold handle; spot resist faucet has matte black handle; black stainless faucet has spot resist stainless handle 			
	1.5 GPM (5.7 L/min) max.			
	S55005	734.45	Chrome	3
	S55005SRS●	918.05	Spot Resist Stainless	3
	S55005BL	954.75	Matte Black	3
S55005BLS●	1064.95	Black Stainless	3	
 DURALOCK® DURALAST®				
STō® ONE-HANDLE KITCHEN BAR PULLDOWN - PREMIUM				
	<ul style="list-style-type: none"> • application: one hole • spout height: 14.63" • connection: 3/8" compression • number of functions: two-function • spray type: aerated stream; powerful cleaning rinse • handle mounting: right only • hose length: 68" 			
	1.5 GPM (5.7 L/min) max.			
	S62308	657.60	Chrome	3
	S62308SRS●	822.00	Spot Resist Stainless	3
	S62308BL	854.90	Matte Black	3
S62308BG	953.50	Brushed Gold	3	
S62308BLC	986.40	Matte Black/Chrome	3	
 POWERCLEAN reflex™ DURALOCK® DURALAST®				

Premium Bar/Prep Faucets

		MODEL	LIST	FINISH/CONNECT	CASE QTY		
 	<ul style="list-style-type: none"> • spray wand: metal • application: one hole • spout height: 14.66" • connection: 3/8" compression • number of functions: two-function • spray type: aerated stream; powerful cleaning rinse • handle mounting: right only • hose length: 68" • included: choice of matching finish or porcelain handle cap 	1.5 GPM (5.7 L/min) max.					
		S53004	627.40	Chrome	3		
		S53004SRS●	784.25	Spot Resist Stainless	3		
		S53004BL	815.65	Matte Black	3		
		S53004NL	847.00	Polished Nickel	3		
		S53004ORB	878.35	Oil Rubbed Bronze	3		
		S53004BG	909.75	Brushed Gold	3		
 POWER CLEAN reflex DURALOCK® DURALAST®							
	<ul style="list-style-type: none"> • application: one hole • spout height: 7.81" • connection: 3/8" compression • spray type: aerated stream • handle mounting: right only 	1.5 GPM (5.7 L/min) max.					
		S62101	647.40	Chrome	3		
		S62101SRS●	809.25	Spot Resist Stainless	3		
		S62101BL	841.65	Matte Black	3		
		S62101NL	874.00	Polished Nickel	3		
		S62101ORB	906.35	Oil Rubbed Bronze	3		
		S62101BG	938.75	Brushed Gold	3		
 DURALAST®							
 	<ul style="list-style-type: none"> • spray wand: metal • application: one hole • spout height: 15.00" • connection: 3/8" compression • number of functions: two-function • spray type: aerated stream; powerful cleaning rinse • handle mounting: right only • hose length: 68" • two-tone art deco-inspired etched handle installed on faucet; secondary matching finish handle option included 	1.5 GPM (5.7 L/min) max.					
		S6235	609.45	Chrome	3		
		S6235SRS●	761.85	Spot Resist Stainless	3		
		S6235BL	792.30	Matte Black	3		
		S6235NL	822.80	Polished Nickel	3		
		 POWER CLEAN reflex DURALOCK® DURALAST®					
		 	<ul style="list-style-type: none"> • spray wand: metal • application: one hole • spout height: 14.31" • connection: 3/8" compression • number of functions: two-function • spray type: aerated stream; powerful cleaning rinse • handle mounting: right only • hose length: 68" • secondary wheel handle option: included 	1.5 GPM (5.7 L/min) max.			
S52003	608.95			Chrome	3		
S52003SRS●	761.15			Spot Resist Stainless	3		
S52003BL	791.60			Matte Black	3		
 POWER CLEAN reflex DURALOCK® DURALAST®							

KITCHEN

Bar/Prep Faucets



KITCHEN



- Cia™
- Align®
- KURV™
- Brantford®
- Arbor®
- Belfield™
- Sleek®
- Camerist®
- Chateau®

Bar/Prep Kitchen Faucets













Combining performance and reliability, Moen® bar/prep faucets are tailored to perfection. Available in your choice of unique design options, these functional collections are sure to complete any kitchen.



CIA™		ONE-HANDLE KITCHEN BAR	MODEL	LIST	FINISH/CONNECT	CASE QTY
 DECKPLATE SOLD SEPARATELY		<ul style="list-style-type: none"> • application: one hole • spout height: 14.00" • connection: 3/8" compression • spray type: aerated stream • handle mounting: right only 	1.5 GPM (5.7 L/min) max.			
			5622	530.55	Chrome	3
			5622SRS●	663.20	Spot Resist Stainless	3
			5622BL	689.75	Matte Black	3
			5622BG	769.30	Brushed Gold	3
OPTIONAL DECKPLATE SOLD SEPARATELY						
			141002	56.60	Chrome	6
			141002SRS●	64.95	Spot Resist Stainless	6
			141002BL	64.95	Matte Black	6
			141002BG	64.95	Brushed Gold	6
		 DURALOCK® DURALAST®				









ALIGN®		ONE-HANDLE KITCHEN BAR PULLDOWN	MODEL	LIST	FINISH/CONNECT	CASE QTY
 DECKPLATE SOLD SEPARATELY		<ul style="list-style-type: none"> • application: one or three hole • spout height: 13.75" • connection: 3/8" compression • number of functions: two-function • spray type: aerated stream; powerful cleaning rinse • handle mounting: right only • hose length: 68" 	1.5 GPM (5.7 L/min) max.			
			5965	505.30	Chrome	3
			5965SRS●	631.65	Spot Resist Stainless	3
			5965BL	656.90	Matte Black	3
			5965BLS●	732.70	Black Stainless	3
			5965BG	732.70	Brushed Gold	3
OPTIONAL DECKPLATE SOLD SEPARATELY						
			141002	56.60	Chrome	6
			141002SRS●	64.95	Spot Resist Stainless	6
			141002BL	64.95	Matte Black	6
			141002BLS●	71.45	Black Stainless	6
			141002BG	64.95	Brushed Gold	6
		 POWER CLEAN reflex DURALOCK® DURALAST®				

Bar/Prep Faucets

		MODEL	LIST	FINISH/CONNECT	CASE QTY		
 <p>DECKPLATE SOLD SEPARATELY</p> 	<p>KURV™ ONE-HANDLE KITCHEN BAR PULLDOWN</p> <ul style="list-style-type: none"> • spray wand: metal • application: one to three hole • spout height: 13.31" • connection: 3/8" compression • number of functions: two-function • spray type: aerated stream; powerful cleaning rinse • handle mounting: right only • hose length: 68" 	1.5 GPM (5.7 L/min) max.					
		6126	494.00	Chrome	3		
		6126SRS●	617.50	Spot Resist Stainless	3		
		6126BL	642.20	Matte Black	3		
		6126NL	666.90	Polished Nickel	3		
		OPTIONAL DECKPLATE SOLD SEPARATELY					
		141002	56.60	Chrome	6		
		141002SRS●	64.95	Spot Resist Stainless	6		
		141002BL	64.95	Matte Black	6		
		141002NL	61.60	Polished Nickel	6		
 POWER CLEAN reflex DURALOCK® DURALAST®							
 <p>DECKPLATE SOLD SEPARATELY</p> 	<p>BRANTFORD® ONE-HANDLE KITCHEN BAR PULLDOWN</p> <ul style="list-style-type: none"> • application: one or three hole • spout height: 14.38" • connection: 3/8" compression • number of functions: two-function • spray type: aerated stream; powerful cleaning rinse • handle mounting: right only • hose length: 68" 	1.5 GPM (5.7 L/min) max.					
		5985ORB	622.40	Oil Rubbed Bronze	3		
		OPTIONAL DECKPLATE SOLD SEPARATELY					
		141002ORB	71.60	Oil Rubbed Bronze	6		
		 POWER CLEAN reflex DURALOCK® DURALAST®					
		 <p>DECKPLATE SOLD SEPARATELY</p> 	<p>ARBOR® ONE-HANDLE KITCHEN BAR PULLDOWN</p> <ul style="list-style-type: none"> • application: one or three hole • spout height: 14.38" • connection: 3/8" compression • number of functions: two-function • spray type: aerated stream; powerful cleaning rinse • handle mounting: right only • hose length: 68" 	1.5 GPM (5.7 L/min) max.			
				5995	415.30	Chrome	3
				5995SRS●	519.10	Spot Resist Stainless	3
				5995BL	539.90	Matte Black	3
				5995ORB	581.40	Oil Rubbed Bronze	3
OPTIONAL DECKPLATE SOLD SEPARATELY							
141002	56.60			Chrome	6		
141002SRS●	64.95			Spot Resist Stainless	6		
141002BL	64.95			Matte Black	6		
141002ORB	71.60			Oil Rubbed Bronze	6		
 POWER CLEAN reflex DURALOCK® DURALAST®							
 <p>DECKPLATE SOLD SEPARATELY</p> 	<p>BELFIELD™ ONE-HANDLE KITCHEN BAR PULLDOWN</p> <ul style="list-style-type: none"> • application: one to three hole • spout height: 14.39" • connection: 3/8" compression • number of functions: two-function • spray type: aerated stream; powerful cleaning rinse • handle mounting: right only • hose length: 68" 	1.5 GPM (5.7 L/min) max.					
		6260	405.85	Chrome	3		
		6260SRS●	507.30	Spot Resist Stainless	3		
		6260BL	527.60	Matte Black	3		
		6260ORB	568.20	Oil Rubbed Bronze	3		
		OPTIONAL DECKPLATE SOLD SEPARATELY					
		141002	56.60	Chrome	6		
		141002SRS●	64.95	Spot Resist Stainless	6		
		141002BL	64.95	Matte Black	6		
		141002ORB	71.60	Oil Rubbed Bronze	6		
 POWER CLEAN reflex DURALOCK® DURALAST®							

KITCHEN

Bar/Prep Faucets

		MODEL	LIST	FINISH/CONNECT	CASE QTY		
GENTA™ LX ONE-HANDLE KITCHEN BAR							
 <p>DECK PLATE INCLUDED</p> <p>NEW!</p> 	<ul style="list-style-type: none"> • application: one hole • spout height: 14.30" • limited spout rotation: 125° • connection: 3/8" compression • spray type: aerated stream • handle mounting: right only <p> DURALOCK® DURALAST®</p>	1.5 GPM (5.7 L/min) max.					
		5882	373.85	Chrome	3		
		5882SRS●	471.10	Spot Resist Stainless	3		
		5882BL	486.05	Matte Black	3		
SLEEK® ONE-HANDLE KITCHEN BAR PULLDOWN							
 <p>DECKPLATE SOLD SEPARATELY</p> 	<ul style="list-style-type: none"> • application: one or three hole • spout height: 14.46" • connection: 3/8" compression • number of functions: two-function • spray type: aerated stream; powerful cleaning rinse • handle mounting: right only • hose length: 68" <p> POWERCLEAN® reflex™ DURALOCK® DURALAST®</p>	1.5 GPM (5.7 L/min) max.					
		7664	370.10	Chrome	3		
		7664SRS●	462.65	Spot Resist Stainless	3		
		7664BL	481.15	Matte Black	3		
		7664ORB	518.15	Oil Rubbed Bronze	3		
		7664BLS●	536.65	Black Stainless	3		
		7664BG	536.65	Brushed Gold	3		
		OPTIONAL DECKPLATE SOLD SEPARATELY					
		141002	56.60	Chrome	6		
		141002SRS●	64.95	Spot Resist Stainless	6		
141002BL	64.95	Matte Black	6				
141002ORB	71.60	Oil Rubbed Bronze	6				
141002BLS●	71.45	Black Stainless	6				
141002BG	64.95	Brushed Gold	6				
CAMERIST® ONE-HANDLE KITCHEN BAR							
	<ul style="list-style-type: none"> • application: two hole • spout height: 11.00" • connection: 3/8" compression • spray type: aerated stream <p> DURALOCK® DURALAST®</p>	1.5 GPM (5.7 L/min) max.					
		4905	265.15	Chrome	3		
		4905SRS●	331.40	Spot Resist Stainless	3		
CHATEAU® TWO-HANDLE KITCHEN BAR							
	<ul style="list-style-type: none"> • application: two hole • spout height: 10.50" • connection: 1/2" IPS • spray type: aerated stream 	1.5 GPM (5.7 L/min) max.					
		4903	128.35	Chrome	12		

Arbor®

Integra®

Chateau®



Laundry Faucets

Take your laundry and utility area to the next level with improved style, simplicity and enhanced mobility. Moen® laundry room faucets feature the best in form and function, with options that elevate everyday tasks such as increased flow rates, extended sink reach, and multiple sprays to make cleaning easier and more efficient.



KITCHEN

		MODEL	LIST	FINISH/CONNECT	CASE QTY
ARBOR®		ONE-HANDLE LAUNDRY PULLDOWN			
 <p>NEW! Q2</p>	<ul style="list-style-type: none"> • application: one hole • spout height: 16.87 • connection: 3/8" compression • threaded spout can accommodate a garden hose • number of functions: one-function • spray type: aerated stream • hose length: 62" • deckplate not available 	4.0 GPM (15.14 L/min) max.			
	<p>reflex DURALAST®</p>	4736	323.00	Chrome	3

INTEGRA®		ONE-HANDLE LAUNDRY PULLOUT			
 <p>DECKPLATE INCLUDED</p> 	<ul style="list-style-type: none"> • application: one or three hole • spout height: 10.63" • connection: 3/8" compression • number of functions: two-function • spray type: aerated stream; powerful cleaning rinse • hose length: 59" • deckplate: included 	1.5 GPM (5.7 L/min) max.			
	<p> POWER CLEAN® DURALOCK® DURALAST®</p>	67315C	313.00	Chrome	6
		67315SRS●	391.30	Spot Resist Stainless	6

Laundry Faucets

		MODEL	LIST	FINISH/CONNECT	CASE QTY
CHATEAU®	TWO-HANDLE KITCHEN LAUNDRY				
	<ul style="list-style-type: none"> • application: two hole • spout height: 6.63" • connection: 1/2" IPS • spray type: aerated stream • water usage: unrestricted 	Unrestricted 4975	130.85	Chrome	12
	DURALAST®				
	<ul style="list-style-type: none"> • application: two hole • spout height: 6.63" • connection: 1/2" IPS • spray type: aerated stream • water usage: unrestricted 	Unrestricted 74998	98.30	Chrome	12
	 DURALAST®				

KITCHEN

3-in-1 Water Filtration Pulldown Kitchen Faucets

Weymouth®

Sinema™

Paterson™

KURV™



Align®



NEW! 3-in-1 Water Filtration Pulldown Kitchen Faucet

The Moen® 3-in-1 Water Filtration Pulldown Kitchen Faucet dispenses both filtered cold water, and hot and cold tap water through two separate water channels, eliminating any chance of mixed water flow. For drinking and cooking, flip the button on the spray head for filtered water; for tap water, use the lever handle. Environmentally friendly, pair with any Moen filtration system to put filtered water at your fingertips.



KITCHEN



		MODEL	LIST	FINISH/CONNECT	CASE QTY
WEYMOUTH®	3-IN-1 WATER FILTRATION PULLDOWN KITCHEN FAUCET – PREMIUM				
NEW! Q3	<ul style="list-style-type: none"> • water filtration at the spray wand • spray wand: metal • application: one hole • spout height: 16.73" • connection: 3/8" compression • number of functions: three-function • spray type: filtered laminar stream; unfiltered aerated stream; unfiltered PowerClean spray • handle mounting: right only • hose length: 68" • included: choice of matching finish or porcelain handle cap 	1.5 GPM (5.7 L/min) max.			
		FS73004	784.40	Chrome	3
		FS73004SRS●	980.50	Spot Resist Stainless	3
		FS73004NL	1058.90	Polished Nickel	3
		FS73004ORB	1098.15	Oil Rubbed Bronze	3
		FS73004BG	1137.35	Brushed Gold	3
	 reflex DURALOCK® DURALAST®				



		MODEL	LIST	FINISH/CONNECT	CASE QTY
SINEMA™	3-IN-1 WATER FILTRATION PULLDOWN KITCHEN FAUCET – PREMIUM				
NEW! Q3	<ul style="list-style-type: none"> • water filtration at the spray wand • spray wand: metal • application: one hole • spout height: 17.75" • connection: 3/8" compression • number of functions: three-function • spray type: filtered laminar stream; unfiltered aerated stream; unfiltered PowerClean spray • handle mounting: right only • hose length: 68" • two-tone art deco-inspired etched handle installed on faucet; secondary matching finish handle option included 	1.5 GPM (5.7 L/min) max.			
		FS7235	780.70	Chrome	3
		FS7235SRS●	975.90	Spot Resist Stainless	3
		FS7235BL	1014.95	Matte Black	3
	 reflex DURALOCK® DURALAST®				

3-in-1 Water Filtration Pulldown Kitchen Faucets

KITCHEN

	MODEL	LIST	FINISH/CONNECT	CASE QTY
PATERSON™ 3-IN-1 WATER FILTRATION PULLDOWN KITCHEN FAUCET – PREMIUM				
 <p>NEW! Q3</p> 	<ul style="list-style-type: none"> • water filtration at the spray wand • spray wand: metal • application: one hole • spout height: 17.00" • connection: 3/8" compression • number of functions: three-function • spray type: filtered laminar stream; unfiltered aerated stream; unfiltered PowerClean spray • handle mounting: right only • hose length: 68" • secondary wheel handle option: included 			
	1.5 GPM (5.7 L/min) max.			
	FS72003	765.55	Chrome	3
	FS72003SRS●	956.95	Spot Resist Stainless	3
	FS72003BL	995.25	Matte Black	3
				

	MODEL	LIST	FINISH/CONNECT	CASE QTY
KURV™ 3-IN-1 WATER FILTRATION PULLDOWN KITCHEN FAUCET				
<p>DECKPLATE SOLD SEPARATELY</p> <p>NEW! Q3</p> 	<ul style="list-style-type: none"> • water filtration at the spray wand • spray wand: metal • application: one hole • spout height: 16.38" • connection: 3/8" compression • number of functions: three-function • spray type: filtered laminar stream; unfiltered aerated stream; unfiltered PowerClean spray • handle mounting: right only • hose length: 68" 			
	1.5 GPM (5.7 L/min) max.			
	F9126	657.30	Chrome	3
	F9126SRS●	821.65	Spot Resist Stainless	3
	F9126BL	854.50	Matte Black	3
OPTIONAL DECKPLATE SOLD SEPARATELY				
	141002	56.60	Chrome	6
	141002SRS●	64.95	Spot Resist Stainless	6
	141002BL	64.95	Matte Black	6
				

	MODEL	LIST	FINISH/CONNECT	CASE QTY
ALIGN® 3-IN-1 WATER FILTRATION PULLDOWN KITCHEN FAUCET				
<p>DECKPLATE SOLD SEPARATELY</p> <p>NEW! Q3</p> 	<ul style="list-style-type: none"> • water filtration at the spray wand • spray wand: metal • application: one hole • spout height: 15.63" • connection: 3/8" compression • number of functions: three-function • spray type: filtered laminar stream; unfiltered aerated stream; unfiltered PowerClean spray • handle mounting: right only • hose length: 68" 			
	1.5 GPM (5.7 L/min) max.			
	F5923	763.90	Chrome	3
	F5923SRS●	954.85	Spot Resist Stainless	3
	F5923BL	993.05	Matte Black	3
	F5923BG	1107.65	Brushed Gold	3
OPTIONAL DECKPLATE SOLD SEPARATELY				
	141002	56.60	Chrome	6
	141002SRS●	64.95	Spot Resist Stainless	6
	141002BL	64.95	Matte Black	6
	141002BG	64.95	Brushed Gold	6
				

SIP DRINKING WATER FAUCETS | REVERSE OSMOSIS & CARBON FILTRATION COMPATIBLE FAUCETS

- Modern
- Traditional
- Transitional

SIP DRINKING WATER FAUCETS | CARBON FILTRATION COMPATIBLE FAUCETS



- Nio™
- Modern
- Paterson™
- Traditional
- KURV™
- Sinema™
- Transitional



NEW! SIP™ Drinking Water



The Moen® SIP™ drinking water faucets make filtering cold tap water at your kitchen sink easier than ever before. They're available in multiple styles and finish options, providing you with a dedicated faucet for clean filtered water that matches the design of your kitchen.





MODEL LIST FINISH/CONNECT CASE QTY



MODERN	REVERSE OSMOSIS & CARBON FILTRATION COMPATIBLE DRINKING WATER FAUCETS				
 <p>NEW! Q2</p>	<ul style="list-style-type: none"> • compatible with Moen filtration systems • integrated air gap for use with Reverse Osmosis Systems • easy, DIY installation • F9800 + F9900 filtration systems sold separately 	1.5 GPM (5.7 L/min) max.			
		F7660	199.95	Chrome	6
		F7660SRS●	249.95	Spot Resist Stainless	6
		F7660BL	259.95	Matte Black	6
					



TRADITIONAL	REVERSE OSMOSIS & CARBON FILTRATION COMPATIBLE DRINKING WATER FAUCETS				
 <p>NEW! Q2</p>	<ul style="list-style-type: none"> • compatible with Moen filtration systems • integrated air gap for use with Reverse Osmosis Systems • easy, DIY installation • F9800 + F9900 filtration systems sold separately 	1.5 GPM (5.7 L/min) max.			
		F7600	199.95	Chrome	6
		F7600SRS●	249.95	Spot Resist Stainless	6
		F7600BL	259.95	Matte Black	6
					



TRANSITIONAL	REVERSE OSMOSIS & CARBON FILTRATION COMPATIBLE DRINKING WATER FAUCETS				
 <p>NEW! Q2</p>	<ul style="list-style-type: none"> • compatible with Moen filtration systems • integrated air gap for use with Reverse Osmosis Systems • easy, DIY installation • F9800 + F9900 filtration systems sold separately 	1.5 GPM (5.7 L/min) max.			
		F7620	199.95	Chrome	6
		F7620SRS●	249.95	Spot Resist Stainless	6
		F7620BL	259.95	Matte Black	6
					



NIO™	CARBON FILTRATION COMPATIBLE FAUCETS - PREMIUM				
	<ul style="list-style-type: none"> • spout height: 10.88 • LED escutcheon for filter life indication • S5500: filtration sold separately • compatible with carbon filtration systems 	1.5 GPM (5.7 L/min) max.			
		S5550	424.35	Chrome	3
		S5550SRS●	530.45	Spot Resist Stainless	3
		S5550BL	551.70	Matte Black	3
		S5550BLS●	615.35	Black Stainless	3
					



Water Filtration Systems & Faucets



		MODEL	LIST	FINISH/CONNECT	CASE QTY	
	<ul style="list-style-type: none"> • spout height: 10.88 • LED escutcheon for filter life indication • S5500: filtration sold separately • compatible with carbon filtration systems 	CARBON FILTRATION COMPATIBLE FACUETS - PREMIUM				
			1.5 GPM (5.7 L/min) max.			
			S5530	424.35	Chrome	3
			S5530SRS●	530.45	Spot Resist Stainless	3
			S5530BL	551.70	Matte Black	3
			S5530BLS●	615.35	Black Stainless	3
	S5530BG	615.35	Brushed Gold	3		
						

		MODEL	LIST	FINISH/CONNECT	CASE QTY	
	<ul style="list-style-type: none"> • spout height: 10.88 • LED escutcheon for filter life indication • S5500: filtration sold separately • compatible with carbon filtration systems 	CARBON FILTRATION COMPATIBLE FACUETS - PREMIUM				
			1.5 GPM (5.7 L/min) max.			
			S5540	424.35	Chrome	3
			S5540SRS●	530.45	Spot Resist Stainless	3
			S5540BL	551.70	Matte Black	3
						

		MODEL	LIST	FINISH/CONNECT	CASE QTY	
	<ul style="list-style-type: none"> • spout height: 10.88 • LED escutcheon for filter life indication • S5500: filtration sold separately • compatible with carbon filtration systems 	CARBON FILTRATION COMPATIBLE FACUETS - PREMIUM				
			1.5 GPM (5.7 L/min) max.			
			S5510	424.35	Chrome	3
			S5510SRS●	530.45	Spot Resist Stainless	3
			S5510BL	551.70	Matte Black	3
			S5510NL	572.90	Polished Nickel	3
			S5510ORB	594.10	Oil Rubbed Bronze	3
			S5510BG	615.35	Brushed Gold	3
						

		MODEL	LIST	FINISH/CONNECT	CASE QTY	
	<ul style="list-style-type: none"> • spout height: 10.88 • LED escutcheon for filter life indication • S5500: filtration sold separately • compatible with carbon filtration systems 	CARBON FILTRATION COMPATIBLE FACUETS - PREMIUM				
			1.5 GPM (5.7 L/min) max.			
			S5560	404.20	Chrome	3
			S5560SRS●	505.20	Spot Resist Stainless	3
			S5560BL	525.45	Matte Black	3
			S5560NL	545.65	Polished Nickel	3
						

		MODEL	LIST	FINISH/CONNECT	CASE QTY	
	<ul style="list-style-type: none"> • spout height: 10.88 • LED escutcheon for filter life indication • S5500: filtration sold separately • compatible with carbon filtration systems 	CARBON FILTRATION COMPATIBLE FACUETS - PREMIUM				
			1.5 GPM (5.7 L/min) max.			
			S5535	396.00	Chrome	3
			S5535SRS●	495.00	Spot Resist Stainless	3
			S5535BL	514.80	Matte Black	3
			S5535NL	534.60	Polished Nickel	3
						

		MODEL	LIST	FINISH/CONNECT	CASE QTY	
	<ul style="list-style-type: none"> • spout height: 10.88 • LED escutcheon for filter life indication • S5500: filtration sold separately • compatible with carbon filtration systems 	CARBON FILTRATION COMPATIBLE FACUETS - PREMIUM				
			1.5 GPM (5.7 L/min) max.			
			S5520	424.35	Chrome	3
			S5520SRS●	530.45	Spot Resist Stainless	3
			S5520BL	551.70	Matte Black	3
			S5520ORB	594.10	Oil Rubbed Bronze	3
			S5520BLS●	615.35	Black Stainless	3
			S5520BG	615.35	Brushed Gold	3
						

Under Sink Water Filtration Systems

- 4-Stage Reverse Osmosis System
- Single Stage Advanced Carbon System
- ChoiceFlo Carbon System





Under Sink Replacement Filters

- Reverse Osmosis Replacement Filters
- Water Filtration Replacement Filters











Under Sink Water Filtration Systems & Replacement Filters

Moen is continuing to enhance the experiences you have in the home with new, comprehensive water filtration solutions that allow you to enjoy every sip right from your kitchen sink. Moen® water filtration products can remove potentially harmful contaminants from your tap water and are better for the environment by helping to reduce plastic waste.





		MODEL	LIST	FINISH/CONNECT	CASE QTY
MOEN® 4-STAGE UNDER SINK REVERSE OSMOSIS ADVANCED WATER FILTRATION SYSTEM					
	<ul style="list-style-type: none"> • provides best quality water by reducing contaminants • 1:1 ratio with high recovery reverse osmosis membrane • includes 3.2 gallon storage tank • compatible with F7620, F7660, and F7600 SIP drinking faucets 	F9900	539.95	N/A or Unfinished	1
					
MOEN® SINGLE STAGE UNDER SINK CARBON ADVANCED WATER FILTRATION SYSTEM					
	<ul style="list-style-type: none"> • filter F9820: included • application: undercounter system • wet change filter replacement notification: yes • battery: included • use with: F7660, F7600 or F7620 series SIP™ drinking water faucets • adapter kit 262578 available to use with: S5510, S5520, S5530, S5540, S5535 and S5560 series SIP drinking water faucets 	F9800	211.95	N/A or Unfinished	2
					
MOEN® CHOICEFLO® CARBON WATER FILTRATION SYSTEM					
	<ul style="list-style-type: none"> • water usage: 0.7 gpm (2.7 L/min) max. • filter: included • application: undercounter • system: dry change • battery: included • use with: S5510, S5520, S5530, S5535, S5540, S5550 and S5560 series 	S5500	370.65	N/A or Unfinished	6

Water Filtration Systems & Faucets

		MODEL	LIST	FINISH/CONNECT	CASE QTY
MOEN®	REVERSE OSMOSIS SEDIMENT STAGE 1 WATER FILTER REPLACEMENT				
 	<ul style="list-style-type: none"> stage 1 of the 4 Stage Reverse Osmosis Water Filtration System removes larger sediments, minerals, and contaminants 6 month filter life 	F9910	74.95	N/A or Unfinished	12
MOEN®	REVERSE OSMOSIS CARBON BLOCK PRE-MEMBRANE STAGE 2 WATER FILTER REPLACEMENT				
 	<ul style="list-style-type: none"> stage 2 of the 4 Stage Reverse Osmosis Water Filtration System removes larger sediments, minerals, and contaminants 6 month filter life 	F9920	74.95	N/A or Unfinished	12
MOEN®	REVERSE OSMOSIS MEMBRANE STAGE 3 WATER FILTER REPLACEMENT				
 	<ul style="list-style-type: none"> stage 3 of the 4 stage Reverse Osmosis Water Filtration System removes larger sediments, minerals, and contaminants 1 to 3 year filter life dependent on water quality 	F9930	139.95	N/A or Unfinished	12
MOEN®	REVERSE OSMOSIS CARBON BLOCK POST MEMBRANE STAGE 4 WATER FILTER REPLACEMENT				
 	<ul style="list-style-type: none"> stage 4 of the 4 Stage Reverse Osmosis Water Filtration System removes larger sediments, minerals, and contaminants 12 month filter life 	F9940	74.95	N/A or Unfinished	12
MOEN®	SINGLE-STAGE ADVANCED WATER FILTER REPLACEMENT				
	<ul style="list-style-type: none"> 12 month filter life 845 gallon capacity improves water color, taste, and smell works with F9800 Advanced Carbon Water Filtration System 	F9820	93.30	N/A or Unfinished	12
MOEN®	SINGLE-STAGE STANDARD WATER FILTER REPLACEMENT				
	<ul style="list-style-type: none"> 6 month filter life 500 gallon capacity improves water color, taste, and smell works with F9800 Advanced Carbon Water Filtration System 	F9810	53.30	N/A or Unfinished	12

Water Filtration Parts and Add-On's

		MODEL	LIST	FINISH/CONNECT	CASE QTY
MOEN®	FILTRATION SUMP REPLACEMENT				
	<ul style="list-style-type: none"> • replacement sump for F9800 • sump to be replaced between 3-5 years 	F9805	100.70	N/A or Unfinished	6

MOEN®	CHOICEFLO® CARBON WATER FILTRATION REPLACEMENT FILTERS				
	<ul style="list-style-type: none"> • includes: replacement battery • use with: SIP faucets, Choiceflo and Aquasuite series 	9601	67.05	N/A or Unfinished	18
	<ul style="list-style-type: none"> • includes: replacement battery • use with: Choiceflo and Aquasuite series 	9501	67.05	N/A or Unfinished	18

MODERN	3-IN-1 WATER FILTRATION PULLDOWN RETRO FIT WAND KIT				
NEW! Q3	<ul style="list-style-type: none"> • 3-function wand offers: unfiltered aerated stream, unfiltered PowerClean spray or filtered laminar stream • style coordinates with any traditional Moen pull-down faucets • Includes: pull-down wand and hose • simple DIY installation • hose length: 68" 	F26660SRS ●	99.95	Spot Resist Stainless	6
		F26660BL	105.95	Matte Black	6

TRADITIONAL	3-IN-1 WATER FILTRATION PULLDOWN RETRO FIT WAND KIT				
NEW! Q3	<ul style="list-style-type: none"> • 3-function wand offers: unfiltered aerated stream, unfiltered PowerClean spray or filtered laminar stream • style coordinates with any traditional Moen pull-down faucets • Includes: pull-down wand and hose • simple DIY installation • hose length: 68" 	F26610SRS ●	99.95	Spot Resist Stainless	6
					

TRANSITIONAL	3-IN-1 WATER FILTRATION PULLDOWN RETRO FIT WAND KIT				
NEW! Q3	<ul style="list-style-type: none"> • 3-function wand offers: unfiltered aerated stream, unfiltered PowerClean spray or filtered laminar stream • style coordinates with any traditional Moen pull-down faucets • Includes: pull-down wand and hose • simple DIY installation • hose length: 68" 	F26620CH	89.95	Chrome	6
		F26620SRS ●	99.95	Spot Resist Stainless	6
		F26620BL	105.95	Matte Black	6

SIP ADAPTER KIT				
Part No.	Finish/Connect	Description		List Price
262578	N/A or Unfinished	<ul style="list-style-type: none"> • adapter kit for use with F9800 • compatible with S5510, S5520, S5530, S5535, S5540, S5560 		22.00

Premium Soap/Lotion Dispensers







KITCHEN

- Modern
- Paterson™
- Traditional
- Transitional







Premium Soap/Lotion Dispensers

Accessorize your kitchen with stylish soap/lotion dispensers from Moen®. They are available in coordinating styles for every decorating taste: traditional, transitional or modern. All come with tops that lift off for easy refill.





		MODEL	LIST	FINISH/CONNECT	CASE QTY
MODERN	SOAP/LOTION DISPENSER - PREMIUM				
	<ul style="list-style-type: none"> • spout height: 5.00" • spout reach: 3.50" • max deck thickness: 3-1/2" • bottle size: 18 ounce refillable bottle • hole diameter: 1-1/8" hole 	S3947C	204.00	Chrome	6
		S3947SRS●	255.00	Spot Resist Stainless	6
		S3947BL	265.20	Matte Black	6
		S3947BLS●	295.80	Black Stainless	6
		S3947BG	295.80	Brushed Gold	6
					
PATERSON™	SOAP/LOTION DISPENSER - PREMIUM				
	<ul style="list-style-type: none"> • spout height: 5.00" • spout reach: 3.50" • max deck thickness: 3-1/2" • bottle size: 18 ounce refillable bottle • hole diameter: 1-1/8" hole 	S3955C	204.00	Chrome	6
		S3955SRS●	255.00	Spot Resist Stainless	6
		S3955BL	265.20	Matte Black	6
					
TRADITIONAL	SOAP/LOTION DISPENSER - PREMIUM				
	<ul style="list-style-type: none"> • spout height: 5.00" • spout reach: 3.50" • max deck thickness: 3-1/2" • bottle size: 18 ounce refillable bottle • hole diameter: 1-1/8" hole 	S3945C	204.00	Chrome	6
		S3945SRS●	255.00	Spot Resist Stainless	6
		S3945BL	265.20	Matte Black	6
		S3945NL	275.40	Polished Nickel	6
		S3945ORB	285.60	Oil Rubbed Bronze	6
S3945BG	295.80	Brushed Gold	6		
					

Premium Soap/Lotion Dispensers

		MODEL	LIST	FINISH/CONNECT	CASE QTY
TRANSITIONAL SOAP/LOTION DISPENSER - PREMIUM					
 <ul style="list-style-type: none"> • spout height: 5.00" • spout reach: 3.50" • max deck thickness: 3-1/2" • bottle size: 18 ounce refillable bottle • hole diameter: 1-1/8" hole 		S3946C	204.00	Chrome	6
		S3946SRS●	255.00	Spot Resist Stainless	6
		S3946BL	265.20	Matte Black	6
		S3946NL	275.40	Polished Nickel	6
		S3946ORB	285.60	Oil Rubbed Bronze	6
		S3946BLS●	295.80	Black Stainless	6
		S3946BG	295.80	Brushed Gold	6
					
 <ul style="list-style-type: none"> • spout height: 5.00" • spout reach: 3.50" • max deck thickness: 3-1/2" • bottle size: 18 ounce refillable bottle • hole diameter: 1-1/8" hole 		S3948C	204.00	Chrome	6
		S3948SRS●	255.00	Spot Resist Stainless	6
		S3948BL	265.20	Matte Black	6
		S3948ORB	285.60	Oil Rubbed Bronze	6
MOEN® SOAP/LOTION DISPENSER					
 <ul style="list-style-type: none"> • spout height: 3.13" • spout reach: 2.75" • max deck thickness: 2-1/4" • bottle size: 18 ounce refillable bottle • hole diameter: 1-1/8" hole 		3942	62.45	Chrome	6
		3942SRS●	78.05	Spot Resist Stainless	6
		3942BL	81.20	Matte Black	6
					
 <ul style="list-style-type: none"> • spout height: 2.56" • spout reach: 3.63" • max deck thickness: 2-1/4" • bottle size: 18 ounce refillable bottle • hole diameter: 1-1/8" hole 		3944	61.25	Chrome	6
		3944SRS●	79.65	Spot Resist Stainless	6
		3944BL	82.70	Matte Black	6
		3944ORB	85.75	Oil Rubbed Bronze	6
					

Kitchen Accessories

		MODEL	LIST	FINISH/CONNECT	CASE QTY
	MOEN® AIR GAP <ul style="list-style-type: none"> • application: one hole • hole diameter: 1-3/8" 	105895	30.80	Chrome	6
		105895SRS●	42.50	Spot Resist Stainless	6
		105895BL	42.15	Matte Black	6
		105895NL	41.10	Polished Nickel	6
		105895ORB	44.40	Oil Rubbed Bronze	6
		105895BLS●	43.35	Black Stainless	6
		105895BG	41.60	Brushed Gold	6

		MODEL	LIST	FINISH/CONNECT	CASE QTY
	MOEN® PULLOUT/PULLDOWN HOSE MANAGEMENT SYSTEM <ul style="list-style-type: none"> • system: helps prevent hose/weight getting caught under sink • size: can be cut to accommodate different cabinet sizes • compatible with: Moen kitchen pulldowns and pullout single mount skus (excluding Aberdeen™) 	159060	22.20	N/A or Unfinished	6

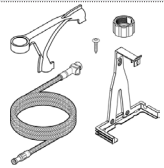
		MODEL	LIST	FINISH/CONNECT	CASE QTY
	MOEN® WALL MOUNT & HOSE EXTENSION KIT <ul style="list-style-type: none"> • use with Smart Faucets with Motion Control and faucets with MotionSense Wave • contains: pulldownconnection hose bracket, house guide nut, mounting bracket and screws 	199785	58.60	N/A or Unfinished	6

		MODEL	LIST	FINISH/CONNECT	CASE QTY
	MOEN® AC ADAPTER KIT <ul style="list-style-type: none"> • use with Smart Faucets and faucets with MotionSense Wave • contains: AC adapter, power splitter, hook & loop fasteners and mounting screw 	169031	156.45	N/A or Unfinished	12

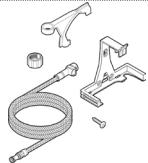
		MODEL	LIST	FINISH/CONNECT	CASE QTY
	MOEN® WALL MOUNT & HOSE EXTENSION KIT <ul style="list-style-type: none"> • use with faucets with MotionSense Wave • contains: pulldownconnection hose bracket, house guide nut, mounting bracket and screws 	177566	48.10	N/A or Unfinished	6

Kitchen Sinks



Please see [moen.com/customer-support/warranty](https://www.moen.com/customer-support/warranty) for complete product warranty information.

Kitchen Sinks

COLLECTIONS

- 112 Fireclay
- 113 Granite
- 115 1800™ Professional Series Workstation Sinks
- 116 1600™ Professional Series
- 117 1800™ Professional Series
- 119 Sink Accessories

FINISHES

- Black
- White
- Stainless

SoundSHIELD™

All Moen stainless steel sinks feature SoundSHIELD, a sound-deadening system that offers exceptional noise reduction and quiet dependability.

QuickMount™

Select Moen sinks include improved installation hardware, making it easier and faster than ever for the professional or the DIYer to get the job done.

ICON KEY

Dimensions noted are nominal. Use template provided with sink for cut-out dimensions.

Full scale DXF files can be downloaded for computer-controlled cutting equipment by visiting MoenPro.com.

Sinks sold in single quantity pack except where noted.

*ADA/FHA Compliant

Sink compliant to ADA (ICC A117.1) and FHA accessibility specifications when installed to these required standards. See specific product specification sheet for details.

**FHA Compliant

Sink compliant to FHA accessibility specifications when installed to these required standards. See specific product specification sheet for details.

Drains and accessories sold separately. See pages 119-122



Also available in Bulk pack.
See page 589



Moen® Kitchen Sinks



GUIDELINES FOR ORDERING

The following guidelines will assist you when ordering sinks.

Series	Description	Gauge	Undermount Options	Dual Mount	Bar/Prep Options	Bowl Depth	SoundSHIELD™	Warranty†
Fireclay	Luxury	N/A	Yes/ Apron Front			10"		Limited Lifetime
Granite	Alternative Colors	N/A	✓	✓	✓	Up to 10"		Limited Lifetime
Workstation	Enhanced Workflow	18	Yes/ Apron Front		✓	Up to 10"	✓	Limited Lifetime
1600™ Professional Series	Modern Style	16	✓		✓	10"	✓	Limited Lifetime
1800™ Professional Series	High Quality, Extensive Selection	18	Yes/ Apron Front	✓	✓	Up to 9"	✓	Limited Lifetime

SKU Number Key

G	G	R	A	18	2	3	3	4	2 B Q
Sink	Material	Granite Finish	Accessory	Gauge	# Bowls	Random Number	# Holes	Drain Size and Placement Combination	
	FC Fireclay	B Black	A Accessory	16 16 Gauge	1 Single		0 None	- 3.5" Drain Size	
	S Stainless	W White		18 18 Gauge	2 Double		1 1 Hole	2 2" Drain Size	
	G Granite				4 Bar/Prep		2 2 Holes	- Center Drain Position	
							3 3 Holes	B Rear Drain Position	
							4 4 Holes	L Left Rear Drain Position	
								R Right Rear Drain Position	
								Q QuickMount Installation Hardware	
								UX Enhanced Workflow	

† For complete product warranty information see moen.com/customer-support/warranty

Fireclay Series

Moen Fireclay Sinks

Moen® Fireclay sinks add a definitive aesthetic touch to any kitchen along with superior performance.

- Apron-front sink bowls
- Low maintenance white glazed finish
- Sound dampening minimizes noise
- Holds large pots and pans and baking sheets
- Professional installation is recommended



FIRECLAY SINGLE BOWL APRON FRONT UNDERMOUNT SINK		MODEL	DESCRIPTION	FINISH	LIST
--	--	-------	-------------	--------	------



- minimum cabinet size: 36"
- depth size: 10"
- drain location: center
- drain opening size: 3⁵/₈"
- weight: 91 lbs.
- includes: strainer and sink grid

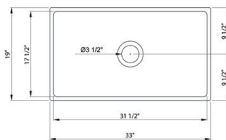

FC331910	single bowl sink	White	970.90
----------	------------------	-------	--------



- minimum cabinet size: 36"
- depth size: 10"
- drain location: center
- drain opening size: 3⁵/₈"
- weight: 103 lbs.
- includes: strainer and sink grid

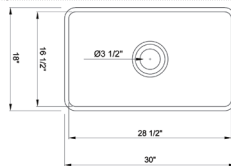

FC301810	single bowl sink	White	895.30
----------	------------------	-------	--------









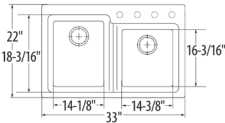

SINKS

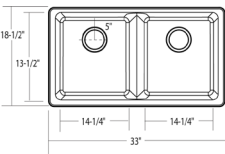
Moen Granite Sinks

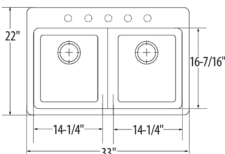
A collection of beautiful granite sinks that will elevate any kitchen's aesthetic. Moen Granite Sinks come in a range of durable, colorful options for your kitchen.

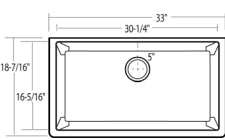
- Composed of natural sound-deadening material for a quieter experience
- Stain resistant surface to avoid cosmetic damage from food and liquid
- Strong impact resistant material
- Heat safe up to 535 degree to withstand damage from hot pots and pans

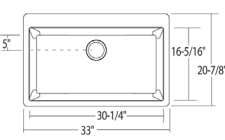

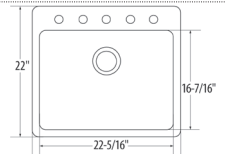
		MODEL	DESCRIPTION	FINISH	LIST
GRANITE DOUBLE OFFSET BOWL DUAL MOUNT SINK					
 <ul style="list-style-type: none"> • minimum cabinet size: 36" • depth size: 9 1/2" • drain location: rear center • drain opening size: 3 5/8" • weight: 60 lbs. 		GGB3024B	double bowl sink	Black	878.15
		GGW3024B	double bowl sink	White	878.15
ACCESSORIES					
		GGA55B	stainless bottom grid		150.95
GRANITE DOUBLE EQUAL BOWL UNDERMOUNT SINK					
 <ul style="list-style-type: none"> • minimum cabinet size: 36" • depth size: 9 1/2" • drain location: rear center • drain opening size: 3 5/8" • weight: 58 lbs. 		GGB4012B	double bowl sink	Black	645.25
		GGW4012B	double bowl sink	White	645.25
GRANITE DOUBLE EQUAL BOWL DUAL MOUNT SINK					
 <ul style="list-style-type: none"> • minimum cabinet size: 36" • depth size: 9 1/2" • drain location: rear center • drain opening size: 3 5/8" • weight: 62 lbs. 		GGB3028B	double bowl sink	Black	641.10
		GGW3028B	double bowl sink	White	641.10
ACCESSORIES					
		GGA55B	stainless bottom grid		150.95
GRANITE SINGLE BOWL UNDERMOUNT SINK					
 <ul style="list-style-type: none"> • minimum cabinet size: 36" • depth size: 9 1/2" • drain location: rear center • drain opening size: 3 5/8" • weight: 55 lbs. 		GGB4010B	single bowl sink	Black	662.40
		GGW4010B	single bowl sink	White	662.40
GRANITE SINGLE BOWL DUAL MOUNT SINK					
 <ul style="list-style-type: none"> • minimum cabinet size: 36" • depth size: 9 1/2" • drain location: rear center • drain opening size: 3 5/8" • weight: 57 lbs. 		GGB3026B	single bowl sink	Black	703.50
		GGW3026B	single bowl sink	White	703.50
ACCESSORIES					
		GGA52B	stainless bottom grid		190.55
 <ul style="list-style-type: none"> • minimum cabinet size: 30" • depth size: 9 1/2" • drain location: rear center • drain opening size: 3 5/8" • weight: 43 lbs. 		GGB3019B	single bowl sink	Black	521.70
		GGW3019B	single bowl sink	White	521.70
ACCESSORIES					
		GGA51B	stainless bottom grid		175.25

Granite Series

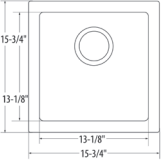
	MODEL	DESCRIPTION	FINISH	LIST
GRANITE SINGLE BOWL DUAL MOUNT BAR/PREP SINK				
 <ul style="list-style-type: none"> • minimum cabinet size: 21" • depth size: 7 3/4" • drain location: rear center • drain opening size: 3 5/8" • weight: 18 lbs. 				
	GGB3018B	single bowl sink	Black	382.65
	GGW3018B	single bowl sink	White	382.65
		ACCESSORIES		
	GGA50B	stainless bottom grid		137.85



SINKS

Workstation Series



All stainless steel sinks feature SoundSHIELD™, a sound-deadening system that offers exceptional noise reduction and quiet dependability.

Moen Workstation Sinks

Making the sink space more efficient through an all-in-one solution designed to enhance workflow and elevate everyday tasks in the kitchen.

- 18 gauge stainless steel sinks
- Tight radius corner for a modern appeal
- Includes;
 - Hardwood cutting board
 - Flexible drying rack
 - Colander
 - Bottom sink grid
 - Drain strainer and cover



		MODEL	DESCRIPTION	FINISH	LIST
1800 SERIES WORKSTATION PROFESSIONAL DOUBLE EQUAL BOWL UNDERMOUNT SINK					
NEW!	<ul style="list-style-type: none"> • minimum cabinet size: 36" • depth size: 10" • drain location: rear center • drain opening size: 3⁵/₈" • workstation includes: cutting board, flexible drying rack, colander, 2 grids and strainers • weight: 48 lbs. 		GS182040BUX	double bowl sink	1350.00
1800 SERIES WORKSTATION PROFESSIONAL SINGLE BOWL UNDERMOUNT SINK					
NEW!	<ul style="list-style-type: none"> • minimum cabinet size: 36" • depth size: 10" • drain location: rear center • drain opening size: 3⁵/₈" • workstation includes: cutting board, flexible drying rack, colander, grid and strainer • weight: 37 lbs. 		GS181020BUX	single bowl sink	1075.00
1800 SERIES WORKSTATION PROFESSIONAL APRON FRONT SINGLE BOWL UNDERMOUNT SINK					
NEW!	<ul style="list-style-type: none"> • minimum cabinet size: 36" • depth size: 9" • drain location: rear center • drain opening size: 3⁵/₈" • workstation includes: cutting board, flexible drying rack, colander, grid and strainer • weight: 44 lbs. 		GS181050BUX	single bowl sink	1425.00

SINKS

1600™ Series



All stainless steel sinks feature SoundSHIELD™, a sound-deadening system that offers exceptional noise reduction and quiet dependability.





1600™ Professional Series Sinks

Constructed from premium, durable 16-gauge stainless steel, the 1600™ Professional Series is built to withstand your toughest chores.

- 16 gauge
- brushed stainless steel finish
- includes mounting brackets where applicable
- includes cut-out template where applicable



SINKS

		MODEL	DESCRIPTION	LIST	
1600 SERIES PROFESSIONAL STYLE DOUBLE OFFSET BOWL UNDERMOUNT SINK					
	<ul style="list-style-type: none"> • minimum cabinet size: 39" • depth size: 10" • drain location: center • drain opening size: 3⁵/₈" • reversible bowl: yes • weight: 45 lbs. 		G16221	double bowl sink	862.90
			ACCESSORIES		
		GA768	stainless bottom grid	166.35	
1600 SERIES PROFESSIONAL STYLE DOUBLE EQUAL BOWL UNDERMOUNT SINK					
	<ul style="list-style-type: none"> • minimum cabinet size: 36" • depth size: 10" • drain location: center • drain opening size: 3⁵/₈" • weight: 42 lbs. 		G16200	double bowl sink	819.70
			ACCESSORIES		
		GA763	stainless bottom grid	140.95	
1600 SERIES PROFESSIONAL STYLE SINGLE BOWL UNDERMOUNT SINK					
	<ul style="list-style-type: none"> • minimum cabinet size: 36" • depth size: 10" • drain location: center • drain opening size: 3⁵/₈" • weight: 39 lbs. 		G16100	single bowl sink	841.30
			ACCESSORIES		
		GA760	stainless bottom grid	190.70	
1600 SERIES PROFESSIONAL STYLE BAR/PREP SINK					
	<ul style="list-style-type: none"> • minimum cabinet size: 24" • depth size: 10" • drain location: center • drain opening size: 3⁵/₈" • weight: 24 lbs. 		G16430	single bowl sink	517.30
			ACCESSORIES		
		GA763	stainless bottom grid	140.95	



All stainless steel sinks feature SoundSHIELD™, a sound-deadening system that offers exceptional noise reduction and quiet dependability.

1800™ Professional Series Sinks

Constructed with strong, high-quality 18-gauge steel, the 1800™ Professional Series provides a solid base for a wide array of design options.

- 18 gauge
- brushed stainless steel finish
- includes mounting brackets where applicable
- includes cut-out template where applicable



1800 SERIES PROFESSIONAL STYLE DOUBLE OFFSET BOWL UNDERMOUNT SINK



- minimum cabinet size: 36"
- depth size: 8½"
- drain location: rear center
- drain opening size: 3⅝"
- weight: 31 lbs.

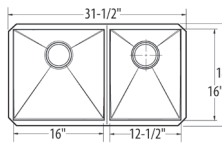

MODEL	DESCRIPTION	LIST
-------	-------------	------

G18287	double bowl sink	571.50
--------	------------------	--------

ACCESSORIES

GA782B	stainless bottom grid	140.95
GA785B	stainless bottom grid	153.80

1800 SERIES PROFESSIONAL STYLE DOUBLE EQUAL BOWL UNDERMOUNT SINK



- minimum cabinet size: 33"
- depth size: 8½"
- drain location: rear center
- drain opening size: 3⅝"
- weight: 29 lbs.

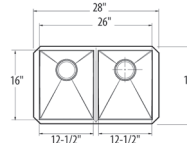

G18288	double bowl sink	646.90
--------	------------------	--------

ACCESSORIES

GA782B	stainless bottom grid	140.95
--------	-----------------------	--------

1800 SERIES PROFESSIONAL STYLE DOUBLE EQUAL BOWL DUAL MOUNT SINK

NEW!



- minimum cabinet size: 36"
- depth size: 9"
- drain location: rear center
- drain opening size: 3⅝"
- depth size: 9"
- drain location: rear center
- weight: 39 lbs.
- includes bottom grids and drains

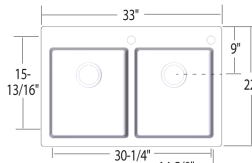

GS182072B	double bowl sink	750.00
-----------	------------------	--------

1800 SERIES PROFESSIONAL STYLE LOW MIDDLE DIVIDE DOUBLE BOWL DUAL MOUNT SINK

NEW!



- minimum cabinet size: 36"
- depth size: 9"
- drain location: rear center
- drain opening size: 3⅝"
- weight: 51 lbs.
- includes bottom grids and drains

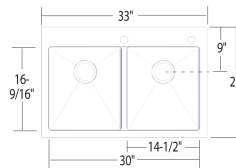

GS182082B	double bowl sink	850.00
-----------	------------------	--------

1800 SERIES APRON FRONT DOUBLE EQUAL BOWL UNDERMOUNT SINK



- minimum cabinet size: 33"
- depth size: 9"
- drain location: rear center
- drain opening size: 3⅝"
- weight: 43 lbs.

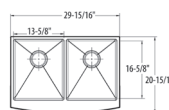









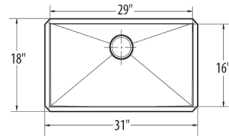

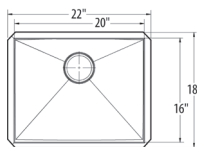
G18220	double bowl sink	1036.20
--------	------------------	---------

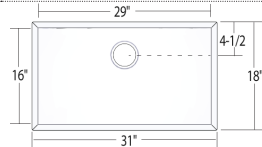
ACCESSORIES

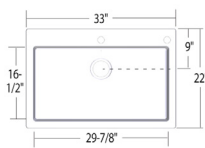
GA772	stainless bottom grid	140.40
-------	-----------------------	--------

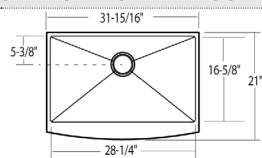
1800™ Series

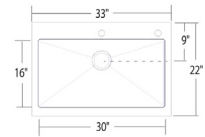

		MODEL	DESCRIPTION	LIST
1800 SERIES PROFESSIONAL STYLE SINGLE BOWL UNDERMOUNT SINK				
 <ul style="list-style-type: none"> • minimum cabinet size: 36" • depth size: 8½" • drain location: rear center • drain opening size: 3⅝" • weight: 28 lbs. 		G18180	single bowl sink	571.50
		ACCESSORIES		GA780B
 <ul style="list-style-type: none"> • minimum cabinet size: 27" • depth size: 8½" • drain location: rear center • drain opening size: 3⅝" • weight: 21 lbs. 		G18185	single bowl sink	442.80
		ACCESSORIES		GA781B
 <p>ADA/FHA COMPLIANT</p> <ul style="list-style-type: none"> • minimum cabinet size: 36" • depth size: 6" • drain location: rear center • drain opening size: 3⅝" • ADA/FHA compliant: yes • weight: 27 lbs. 		GS181210B◆	single bowl sink	514.35
1800 SERIES PROFESSIONAL STYLE SINGLE BOWL DUAL MOUNT SINK				
 <p>NEW!</p> <ul style="list-style-type: none"> • minimum cabinet size: 36" • depth size: 9" • drain location: rear center • drain opening size: 3⅝" • weight: 38 lbs. • includes bottom grid and drain 		GS181062B	single bowl sink	750.00
1800 SERIES PROFESSIONAL STYLE APRON FRONT SINGLE BOWL UNDERMOUNT SINK				
 <ul style="list-style-type: none"> • minimum cabinet size: 30" • depth size: 9" • drain location: rear center • drain opening size: 3⅝" • weight: 39 lbs. 		G18121	single bowl sink	884.50
		ACCESSORIES		GA771
1800 SERIES PROFESSIONAL STYLE APRON FRONT SINGLE BOWL DUAL MOUNT SINK				
 <p>NEW!</p> <ul style="list-style-type: none"> • minimum cabinet size: 36" • depth size: 9" • drain location: rear center • drain opening size: 3⅝" • weight: 54 lbs. • includes bottom grid and drain 		GS181092B	single bowl sink	975.00

SINKS





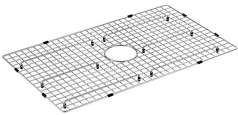
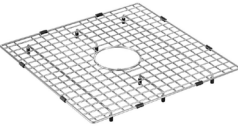
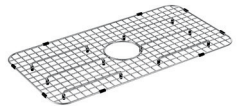
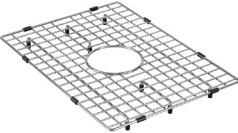

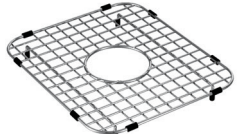
Custom Sink Accessories



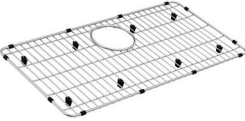



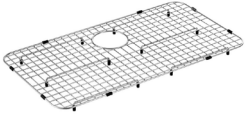
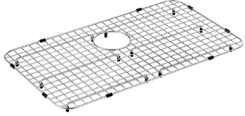
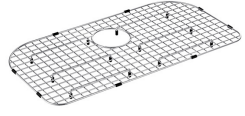
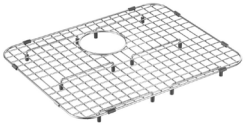

Tasks in and around the sink are easier with Moen® custom sink accessories. Available in a variety of sizes for the perfect fit, these accessories protect the sink from tough tasks and are a great complement to Moen stainless steel and granite sinks.







	MODEL	LIST	FINISH	CASE QTY
CENTER DRAIN GRID ACCESSORY				
 <ul style="list-style-type: none"> • features: stainless steel construction • fits bowl size: 30" x 18" professional center drain 	GA760	190.70	Satin Stainless	3
 <ul style="list-style-type: none"> • features: stainless steel construction • fits bowl size: 18" x 18" center drain 	GA768	166.35	Satin Stainless	10
 <ul style="list-style-type: none"> • features: stainless steel construction • fits bowl size: 29" x 16" center drain 	GA719	163.00	Satin Stainless	6
 <ul style="list-style-type: none"> • features: stainless steel construction • fits bowl size: 13" x 18" professional center drain 	GA763	140.95	Satin Stainless	6
 <ul style="list-style-type: none"> • features: stainless steel construction • fits bowl size: 21" x 16" center drain 	GA716	112.80	Satin Stainless	10
 <ul style="list-style-type: none"> • features: stainless steel construction • fits bowl size: 14" x 18" center drain 	GA728	107.00	Satin Stainless	12
 <ul style="list-style-type: none"> • features: stainless steel construction • fits bowl size: 14" x 16" center drain 	GA726	79.30	Satin Stainless	15

Custom Sink Accessories

		MODEL	LIST	FINISH	CASE QTY
REAR DRAIN GRID ACCESSORY					
	<ul style="list-style-type: none"> • features: stainless steel construction • fits bowl size: 27.5" x 13.5" professional rear drain • for use with Moen granite sinks 	GGA52B	190.55	Satin Stainless	9
	<ul style="list-style-type: none"> • features: stainless steel construction • fits bowl size: 19.81" x 13.81" professional rear drain • for use with Moen granite sinks 	GGA51B	175.25	Satin Stainless	10
	<ul style="list-style-type: none"> • features: stainless steel construction • fits bowl size: 12" x 12.75" professional rear drain • for use with Moen granite sinks 	GGA55B	150.95	Satin Stainless	10
	<ul style="list-style-type: none"> • features: stainless steel construction • fits bowl size: 10.50" x 13.94" rear drain • for use with Moen granite sinks 	GGA57B	143.60	Satin Stainless	9
	<ul style="list-style-type: none"> • features: stainless steel construction • fits bowl size: 10.75" x 10.75" professional rear drain • for use with Moen granite sinks 	GGA50B	137.85	Satin Stainless	9
	<ul style="list-style-type: none"> • features: stainless steel construction • fits bowl size: 29" x 16" professional rear drain 	GA780B	186.30	Satin Stainless	6
	<ul style="list-style-type: none"> • features: stainless steel construction • fits bowl size: 28" x 16" rear drain 	GA771	183.25	Satin Stainless	6
	<ul style="list-style-type: none"> • features: stainless steel construction • fits bowl size: 29x16 D-shaped drain 	GA749B	170.45	Satin Stainless	6
	<ul style="list-style-type: none"> • features: stainless steel construction • fits bowl size: 20" x 16" professional rear drain 	GA781B	166.35	Satin Stainless	8
	<ul style="list-style-type: none"> • features: stainless steel construction • fits bowl size: 16" x 16" professional rear center drain 	GA785B	153.80	Satin Stainless	6
	<ul style="list-style-type: none"> • features: stainless steel construction • fits bowl size: 12.5" x 16" professional rear drain 	GA782B	140.95	Satin Stainless	15

	MODEL	LIST	FINISH	CASE QTY
REAR DRAIN GRID ACCESSORY (CONTINUED)				
 <ul style="list-style-type: none"> • features: stainless steel construction • fits bowl size: 13.6" x 16.6" rear drain 	GA772	140.40	Satin Stainless	12
RINSE BASKET				
 <ul style="list-style-type: none"> • features: stainless steel construction • fits bowl size: 14" x 16" 	GA821	103.80	Satin Stainless	10
 <ul style="list-style-type: none"> • features: stainless steel construction • fits bowl size: 13" x 16.5" 	GA841	140.40	Satin Stainless	10
DRAIN ASSEMBLY				
 <ul style="list-style-type: none"> • features: drop-in basket strainer with drain assembly: 3 1/2" • includes: lock nut • fits sinks with standard 3 5/8" outlet 	22036	21.65	Stainless	24
 <ul style="list-style-type: none"> • features: drop-in basket strainer with drain assembly: 3 1/2" • includes: lock nut • fits sinks with standard 3 5/8" outlet 	22037	18.95	Satin	40
 <ul style="list-style-type: none"> • features: basket strainer with drain assembly: 2" • includes lock nut • fits sinks with standard 2" outlet 	22174	9.80	N/A or Unfinished	30
DRAIN ASSEMBLY				
 <ul style="list-style-type: none"> • drop-in basket strainer with drain assembly: 3 1/2" • fits sinks with standard 3 5/8" outlet • includes: basket strainer, and stopper • for use with: granite sinks • color match: coordinate drain to match color of Moen granite sinks 	GGA60B	83.85	Black	56
	GGA60W	83.85	White	56
BASKET STRAINER				
 <ul style="list-style-type: none"> • drop-in basket strainer: 3 1/2" • fits sinks with standard 3 1/2" outlet 	22194	6.80	N/A or Unfinished	100

Custom Sink Accessories

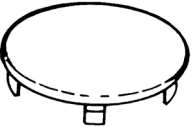
	MODEL	LIST	FINISH	CASE QTY
DISPOSER FLANGE AND BASKET STRAINER				
 <ul style="list-style-type: none"> • disposer flange: removable basket strainer and rubber stopper • color match: coordinate your drain to match the color of Moen granite sinks • disposer ready: designed for garbage disposals that accommodate 4½" flange 	GGA61B	96.95	Black	72
	GGA61W	96.95	White	72
INSTALLATION CLAMP				
 <ul style="list-style-type: none"> • u-channel clamp: 8 pieces • u-channel clamp: 10 pieces • u-channel clamp: 12 pieces 	22684	4.45	N/A or Unfinished	1
	22681	5.40	N/A or Unfinished	1
	22682	6.40	N/A or Unfinished	1
INSTALLATION BRACKET				
 <ul style="list-style-type: none"> • undermount bracket pack: 10 pieces 	22650	14.25	N/A or Unfinished	1
INSTALLATION SCREW				
 <ul style="list-style-type: none"> • u-channel 3" extension screw: 1 piece 	22175	4.95	N/A or Unfinished	1000
HOLE COVER				
 <ul style="list-style-type: none"> • hole cover: 1½" • finish: stainless 	22897	1.15	Satin Stainless	1

Garbage Disposals



GT Series 1/2 HP Garbage Disposal / GT50c

Please see [moen.com/customer-support/warranty](https://www.moen.com/customer-support/warranty) for complete product warranty information.
Learn more at [moen.com/disposalinstall](https://www.moen.com/disposalinstall)

Garbage Disposals

Featuring Lite, Prep, Host and Chef Series

COLLECTIONS

- 125 EXL Series
- 127 GX Series
- 127 GT Series
- 128 GX Pro Series
- 129 Accessories

Whether you're a five-star chef or prefer to order takeout, Moen offers a complete line of garbage disposals to suit any homeowner's needs in the kitchen, with a range of choices that make it simple to find the disposal that's just right for your lifestyle. No matter the level of grinding power, each Moen disposal is designed to make kitchen cleanup a breeze, tackling even the toughest, hardest foods with ease.



EXL SERIES Garbage Disposals

EXL SERIES	MODEL	LIST	CASE QTY
------------	-------	------	----------



- motion sensing technology: light activates when under cabinet door is open with positionable sensor
- battery compartment: front facing
- engine: 1 horsepower with 2800 RPM
- feed: continuous feed
- dishwasher: connects with 1-1/2" drain outlet
- 13 lbs. 16" height
- grind component material: stainless steel
- turntable material: stainless steel
- includes: easy open dishwasher inlet; drain stopper; hardwire capable cord; reset button; removable splash guard; pre-installed power cord; light; simple snap tool; drain elbow and mounting assembly
- 10 year limited warranty with in-home service

EXL100c

507.30

2



GARBAGE DISPOSALS



Universal Xpress Mount™ fits Moen and most existing 3-bolt mounting assemblies



High-speed VORTEX™ motor provides fast, powerful grinding



Continuous feed grinds as long as power is on



Permanent magnet motor designed to help reduce jamming



SoundSHIELD™ designed to provide sound deadening insulation



Pre-installed power cord is a savings over other models where cord must be purchased separately



360 Clean Rinse design eliminates odors

Learn more at moen.com/disposalinstall

GX SERIES Garbage Disposals

		MODEL	LIST	CASE QTY
GX SERIES				
	<ul style="list-style-type: none"> • engine: 1 horsepower with 2800 RPM • feed: continuous feed • dishwasher: connect with 1-1/2" drain outlet • 13 lbs. 16" height • grind component material: stainless steel • turntable material: stainless steel • includes: polished stainless steel sink flange; removable splash guard; pre-installed power cord; drain elbow and mounting assembly; drain stopper • 10 year limited warranty with in-home service 	GX100c	415.20	1
	<ul style="list-style-type: none"> • engine: 3/4 horsepower with 2700 RPM • feed: batch feed • dishwasher: connect with 1-1/2" drain outlet • 11 lbs. 15-5/8" height • grind component material: galvanized steel • turntable material: stainless steel • includes: polished stainless steel sink flange; removable splash guard; pre-installed power cord; drain elbow and mounting assembly; drain stopper • 10 year limited warranty with in-home service 	GXB75c	356.85	2
	<ul style="list-style-type: none"> • engine: 3/4 horsepower with 2700 RPM • feed: continuous feed • dishwasher: connect with 1-1/2" drain outlet • 10.25 lbs. 13-3/8" height • grind component material: galvanized steel • turntable material: stainless steel • includes: polished stainless steel sink flange; drain stopper; removable splash guard; pre-installed power cord; drain elbow and mounting assembly; drain stopper • 10 year limited warranty with in-home service 	GXS75c	266.40	2
	<ul style="list-style-type: none"> • engine: 1/2 horsepower with 2600 RPM • feed: continuous feed • dishwasher: connect with 1-1/2" drain outlet • 9.25 lbs. 13 3/8" height • grind component material: stainless steel • turntable material: stainless steel • includes: polished stainless steel sink flange; removable splash guard; pre-installed power cord; drain elbow and mounting assembly; drain stopper • 5 year limited warranty with in-home service 	GX50c	191.95	2



GARBAGE DISPOSALS



Universal Xpress Mount™ fits Moen and most existing 3-bolt mounting assemblies



High-speed VORTEX™ motor provides fast, powerful grinding



Continuous feed grinds as long as power is on



Batch Feed Stopper activates disposal for safer operation. No wall switch required



Permanent magnet motor designed to help reduce jamming



Pre-installed power cord is a savings over other models where cord must be purchased separately



















Pre-installed power cord is a savings over other models where cord must be purchased separately



360 Clean Rinse design eliminates odors

Learn more at moen.com/disposalinstall

GT SERIES Garbage Disposals

		MODEL	LIST	CASE QTY
GT SERIES				
	<ul style="list-style-type: none"> • engine: 1/2 horsepower with 2600 RPM • feed: continuous feed • dishwasher: connects with 1-1/2" drain outlet • 8.50 lbs. 13-3/8" height • grind component material: galvanized steel • turntable material: stainless steel • includes: easy open dishwasher inlet; drain elbow and mounting assembly; drain stopper; hardwire capable cord; unjamming wrench; reset button; pre-installed power cord; removable splash guard; simple snap tool • 5 year limited warranty with in-home service 	GT50c	165.15	2
	      			
	<ul style="list-style-type: none"> • engine: 1/3 horsepower with 1900 RPM • feed: continuous feed • dishwasher: connects with 1-1/2" drain outlet • 7.75 lbs. 13-3/8" height • grind component material: galvanized steel • turntable material: stainless steel • includes: easy open dishwasher inlet; drain elbow and mounting assembly; drain stopper; unjamming wrench; reset button; pre-installed power cord; removable splash guard; simple snap tool; hardwire capable cord • 5 year limited warranty with in-home service 	GT33c	137.25	2
	      			



Installation Innovation-Fast Track™ enhanced features for faster installation.

Features:

- Simple Snap Tool quickly secures mounting assembly
- Easy Open Dishwasher Inlet. No additional tools required
- Pre-installed power cord is a savings over models where cord must be purchased separately. Cord easily removes for optional hardwiring.



Universal Xpress Mount™ fits Moen and most existing 3-bolt mounting assemblies



High-speed VORTEX™ motor provides fast, powerful grinding



Continuous feed grinds as long as power is on



Permanent magnet motor designed to help reduce jamming



SoundSHIELD™ designed to provide sound deadening insulation

















Pre-installed power cord is a savings over other models where cord must be purchased separately



360 Clean Rinse design eliminates odors

Learn more at moen.com/disposalinstall

GX PRO SERIES Garbage Disposals

		MODEL	LIST	CASE QTY
GX PRO SERIES				
	<ul style="list-style-type: none"> • engine: 1/2 horsepower with 2600 RPM • feed: continuous feed • dishwasher: connects with 1-1/2" drain outlet • 8.50 lbs. 13-3/8" height • grind component material: galvanized steel • turntable material: stainless steel • includes: drain elbow and mounting assembly; polished stainless steel sink flange; pre-installed power cord; removable splash guard; drain stopper • 5 year limited warranty with in-home service 	GXP50c	148.70	2
	     			
	<ul style="list-style-type: none"> • engine: 1/3 horsepower with 1900 RPM • feed: continuous feed • dishwasher: connects with 1-1/2" drain outlet • 7.75 lbs. 13-3/8" height • grind component material: galvanized steel • turntable material: stainless steel • includes: drain elbow and mounting assembly; stainless steel sink flange; pre-installed power cord; removable splash guard; drain stopper • 5 year limited warranty with in-home service 	GXP33c	126.40	2
	     			

GARBAGE DISPOSALS



Universal Xpress Mount™ fits Moen and most existing 3-bolt mounting assemblies



High-speed VORTEX™ motor provides fast, powerful grinding



Continuous feed grinds as long as power is on



Permanent magnet motor designed to help reduce jamming



SoundSHIELD™ designed to provide sound deadening insulation



Pre-installed power cord is a savings over other models where cord must be purchased separately









360 Clean Rinse design eliminates odors

Learn more at moen.com/disposalinstall

ACCESSORIES Garbage Disposals

		MODEL	LIST	CASE QTY
CONTROLLER BASE UNIT WITH CHROME & SATIN NICKEL SWITCH				
	<ul style="list-style-type: none"> • includes: interchangeable chrome and satin nickel button finishes • air tubing size: 1/8" • mounting hole size: 1-3/8" • air tube length: 10' • compatible with all disposals • 1 year limited warranty • ideal application for island countertop where electrical switch is unavailable 	ARC-4200-CH/SN	87.60	6
DISPOSAL AIR SWITCH CONTROLLER				
	<ul style="list-style-type: none"> • application: one hole • air tubing size: 1/8" • mounting hole size: 1-3/8" • air tube length: 10' • compatible with all disposals • 1 year limited warranty • ideal application for island countertop where electrical switch is unavailable 	ARC-4200	66.75	60
AIR SWITCH				
	<ul style="list-style-type: none"> • requires disposal air switch controller ARC-4200 sold separately • assortment of finishes available to coordinate with faucets and sinks • compatible with all disposals • 1 year limited warranty 	AS-4201-CH 22.45 100 AS-4201-BL 28.05 100 AS-4201-BLS ● 33.90 100 AS-4201-BRB 33.90 100 AS-4201-NL 39.85 100 AS-4201-BG 44.85 100 AS-4201-SN 44.85 100		
POLISHED STAINLESS DRAIN STOPPER				
	<ul style="list-style-type: none"> • compatible with all Moen disposals & other 3-bolt mounting systems • 1 year limited warranty 	1011	17.35	24
PLASTIC DRAIN STOPPER				
	<ul style="list-style-type: none"> • compatible with all Moen disposals & other 3-bolt mounting systems • 1 year limited warranty 	186589	9.95	6
REMOVABLE SPLASH GUARD				
	<ul style="list-style-type: none"> • helps clear food scraps that cause odor for a more complete rinse • compatible with all Moen branded garbage disposals • no tools needed for installation • 5 year limited warranty 	205497	11.25	100

ACCESSORIES Garbage Disposals

		MODEL	LIST	CASE QTY
DISHWASHER CONNECTOR KIT				
	<ul style="list-style-type: none"> connects 1-1/4", 1" and 3/4" outside diameter dishwasher drain hoses to the 1-1/2" garbage disposal dishwasher inlet compatible with all Moen disposals & other 3-bolt mounting systems 1 year limited warranty 	1023	8.95	24
DRAIN ELBOW & GASKET				
	<ul style="list-style-type: none"> compatible with all Moen disposals & other 3-bolt mounting systems 1 year limited warranty 	1026	10.05	6
POLISHED SINK FLANGE				
	<ul style="list-style-type: none"> for sinks 3/4" thick or less compatible with all Moen & other 3-bolt mount systems 1 year limited warranty 	1017	17.90	50
UNIVERSAL XPRESS MOUNT ASSEMBLY				
	<ul style="list-style-type: none"> compatible with all Moen disposals & other 3-bolt mounting systems polished stainless steel construction for additional durability 1 year limited warranty 	1824	21.30	10
DISPOSAL UNJAMMING WRENCH				
	<ul style="list-style-type: none"> allows users to clear jam from above the sink compatible with all Moen disposals 1 year limited warranty 	1037	9.95	10
DISPOSAL POWER CORD KIT				
	<ul style="list-style-type: none"> compatible with all disposals 1 year limited warranty 	1024	10.95	24

eBidet and eToilet



Please see [moen.com/customer-support/warranty](https://www.moen.com/customer-support/warranty) for complete product warranty information.

eBidet and eToilet

COLLECTIONS

- 133 Electronic Bidet Seats
- 134 Non-Electronic Bidet Seats
- 135 Electronic Cleansing Toilets

FINISHES

- White
- Biscuit

ICON KEY



ADA

ADA Compliant - Many Moen® faucets, sinks and shower valve controls meet requirements for the physically challenged



WaterSense Labeled



Product has been tested and is certified to meet EPA flow control criteria.





eBidets
eToilets

Achieve personalized comfort and enhanced cleanliness with Moen's Bidet Seats, Electronic Bidet Seats (eBidets) and Electronic Toilets (eToilets). Easily retrofit any of the bidet seats onto any toilet or replace your current toilet with a tankless eToilet to elevate the design of the bathroom and experience a customized routine tailored to meet your needs for the perfect clean, every time.









	MODEL	LIST	FINISH/CONNECT	CASE QTY
ELECTRONIC BIDET SEAT - 5 SERIES				
 <ul style="list-style-type: none"> • plugs into 120V grounded outlet • retrofit existing traditional toilet • elongated design • front and rear cleansing • pulsating and oscillating cleanse • self-cleaning options with replaceable nozzles • UV technology • endless & instantaneous warm water • adjustable water temperature and pressure • hot or cold massage, nozzle position adjustment and dual nozzles for enhanced personal cleaning • soft-close lid and seat • hygienic seat • heated seat with temperature control and sensor • operates with a remote control • warm air dryer with temperature control • nightlight • deodorizer • ADA Compliant 	EB2100-E	844.60	White	1

ELECTRONIC BIDET SEAT - 3 SERIES				
 <ul style="list-style-type: none"> • plugs into 120V grounded outlet • retrofit existing traditional toilet • elongated design • front and rear cleansing • pulsating and oscillating cleanse • self-cleaning options with replaceable nozzles • endless & instantaneous warm water • adjustable water temperature and pressure • hot or cold massage, nozzle position adjustment and dual nozzles for enhanced personal cleaning • soft-close lid and seat • hygienic seat • heated seat with temperature control and sensor • operates via a remote control • nightlight • ADA Compliant 	EB1500-E	613.85	White	1
	EB1500-EBS	706.20	Biscuit	1







EBIDET AND ETOILET

eBidets and eToilets

		MODEL	LIST	FINISH/CONNECT	CASE QTY
ELECTRONIC BIDET SEAT - 3 SERIES					
 <ul style="list-style-type: none"> • plugs into 120V grounded outlet • retrofit existing traditional toilet • elongated design • front and rear cleansing • pulsating and oscillating cleanse • self-cleaning options with replaceable nozzles • endless & instantaneous warm water • adjustable water temperature and pressure • nozzle position adjustment and dual nozzles for enhanced personal cleaning • soft-close lid and seat • hygienic seat • heated seat with temperature control and sensor • nightlight • convenient control panel for operation 		EB1000	438.70	White	1
ELECTRONIC BIDET SEAT - 2 SERIES					
 <ul style="list-style-type: none"> • plugs into 120V grounded outlet • retrofit existing traditional toilet • elongated design • dual nozzles for front and rear cleansing • self-cleaning options with replaceable nozzles • endless and instantaneous warm water • adjustable water temperature & pressure • soft-close lid and seat • hygienic seat • heated seat with temperature control and sensor • operates with an easy turn knob and buttons • quick release hinges • ADA Compliant 		EB800-E	305.30	White	1
NON-ELECTRONIC BIDET SEAT 2-SERIES					
 <ul style="list-style-type: none"> • retrofit existing traditional toilet • elongated design • dual nozzles for front and rear cleansing • water pressure control • soft-close lid and seat -Self-cleaning options with replaceable nozzles • operates via an easy turn knob • quick release hinges • ADA compliant 		EB500-E	144.00	White	5
 <ul style="list-style-type: none"> • retrofit existing traditional toilet • round design • dual nozzles for front and rear cleansing • water pressure control • soft-close lid and seat • self-cleaning options with replaceable nozzles • operates via an easy turn knob • quick release hinges • ADA compliant 		EB500-R	144.00	White	5

EBIDET AND ETOILET

eBidets and eToilets

	MODEL	LIST	FINISH/CONNECT	CASE QTY
ELECTRONIC CLEANSING TOILET - 5-SERIES				
 <ul style="list-style-type: none"> • bidet features with front and rear cleansing; pulsating and oscillating cleanse • self-cleaning, replaceable nozzles with UV technology • aerated spray • endless and instantaneous warm water • adjustable water temperature and pressure • soft-close lid and seat • hygienic heated seat with sensor and temperature control • automatic and remote flush • manual side knob and remote control • convenient remote-control activation including remote opening of seat and lid • automatic open/close seat and lid • foot touch open/close seat and lid plus foot touch flush • auto-close and auto-flush feature • auto-sensing nightlight • warm air dryer with temperature control and flash drying • pre-wets bowl to stay clean longer • deodorizer • battery back-up for flush control • comfort height seat • ADA Compliant 	ET2200	5229.25	White	1
ELECTRONIC CLEANSING TOILET - 3 SERIES				
 <ul style="list-style-type: none"> • bidet features with front and rear cleansing; pulsating and oscillating cleanse • self-cleaning, replaceable nozzles with UV technology • aerated spray • endless and instantaneous warm water • adjustable water temperature and pressure • soft-close lid and seat • hygienic heated seat with sensor and temperature control • automatic and remote flush • manual side knob and remote control • auto-sensing nightlight • warm air dryer with temperature control and flash drying • pre-wets bowl to stay clean longer • deodorizer • comfort height seat • ADA Compliant 	ET1300	3536.95	White	1
ELECTRONIC CLEANSING TOILET - 2 SERIES				
 <ul style="list-style-type: none"> • bidet features with front and rear cleansing; pulsating and oscillating cleanse • self-cleaning options with replaceable nozzles • aerated spray • endless and instantaneous warm water • adjustable water temperature and pressure • soft-close lid and seat • hygienic heated seat with sensor and temperature control • automatic and remote flush • manual side knob and remote control • auto-sensing nightlight • warm air dryer with temperature control • pre-wets bowl to stay clean longer • comfort height seat • ADA Compliant 	ET900	1921.55	White	1

BATH AND SHOWER





EASYGOING ELEGANCE

From modern farmhouse, to Mid-Century or soft modern, the Greenfield™ bathroom collection of faucets and shower fixtures adapts well to any space with clean, simple lines and subtle chamfered edges that easily shift from classic to contemporary.

Greenfield Widespread Bathroom Faucet, Two Globe Bath Light and Wallmount Tub Filler



Bath and Shower

Bath collections and matching accessories

COLLECTIONS

145 Weymouth®
159 Arris®
169 Flara™
182 Colinet™
193 90°®
205 Via®
207 Doux™
218 Greenfield™
229 Wynford®
240 Align®
252 Rizon®
261 Belfield™
274 Cia™
283 Voss™
297 Dartmoor®
304 Glyde™
310 Brantford®
319 Eva®
329 Vichy®
334 Gibson™
342 Genta™ LX
350 Chateau®

FINISHES

Chrome
Brushed Nickel
Brushed Gold
Polished Nickel
Oil Rubbed Bronze
Matte Black
Matte Black/Chrome
Wrought Iron/Matte Black
Brushed Chrome

LifeShine® Non-Tarnish Finish
All Brushed Nickel, Brushed Gold and Polished Nickel faucet components feature the LifeShine Non-Tarnish Finish.

Wrought Iron/Matte Black
Wrought Iron and Matte Black are the same finish and interchangeable.

ICON KEY



WaterSense Labeled

Product has been tested and is certified to meet EPA flow control criteria.



MotionSense Wave™ Hands-Free Faucet

MotionSense Wave™ touchless faucets allow you to easily turn water on and off with the wave of a hand.



Immersion® Rainshower

Immersion Rainshower's innovative technology provides optimal water pressure and excellent coverage for an unparalleled shower experience.



Moen® M•PACT® Common Valve System

With M•PACT, you can change your faucet style without replacing any plumbing. It's as easy as changing a light bulb.

DURALOCK®

Push-button connector that makes installing faucets quick, secure and hassle-free – no tools required. A telltale 'click' audibly signals a secure connection.

DURALAST®

Duralast Cartridge

Provides the smooth feel and reliable operation of a new faucet from the first time you use it to the last.



Also available in bulk pack.
See page 589.



Available in bulk pack only.



Versatile. Durable. Built To Perform.

Moen® Roman tub valve improvements are designed for faster, more secure mounting on a wider variety of tub decks. Plus, an expanded portfolio of connection options makes installation even easier for installers of all skill levels.

Key Features and Improvements

MORE!

Supply Connection Options

Moen also recognizes the increased use of PEX, cold expansion PEX and CPVC supply lines. Plumbers can now order valves designed to work directly with all types of piping — including copper. No other manufacturer offers more options.

Dura-Grip® Mounting System

This robust engineered system, where the mounting hardware components work together to prevent the valves and spout from moving after installation, also provides features that work with all types of surfaces (on both fixed and adjustable valves).

IMPROVED!

Standardized Drill Holes

Only one drill bit (1¼") is needed for all spout and handle holes to further speed and simplify installation.

TEST PLUG

All models include a test plug for high-pressure testing after rough-in.

Fixed Roman Tub Valve

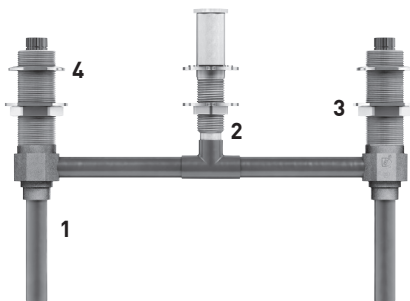

1. Robust, Pre-Soldered Design

Set to standard 10" centers.

2. Dura-Grip Mounting Hardware

Improved design works with all deck materials including wood, fiberglass, tile and stone.

3. Versatile

Fits finished tub decks from ⅛" to 1 ⅜" thick.

4. M•PACT® Common Valve System Compatible

Accepts all Moen Roman tub trim kits. 

Adjustable Roman Tub Valve

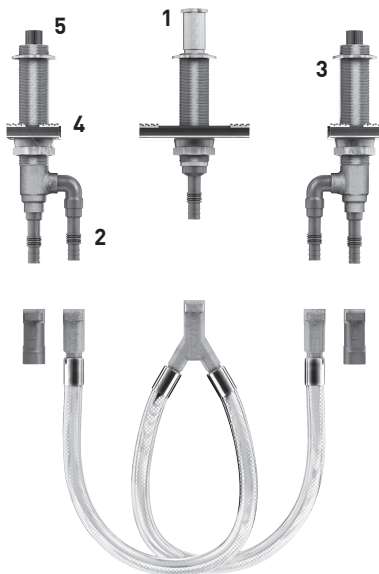

1. No-Cut Adjustable Spout Shank

Loosen an expansion nut, extend and lock in place using the supplied metal tool.

2. Quick-Connect Flexible Hose

Braided PVC tube for easy connections.

3. 3 ⅜" Rough-In Deck Thickness

Adapts to decks from ⅛" to 2 ¾" thick — with an additional 1¼" of available adjustability to accommodate finish materials.

4. Dura-Grip Mounting System

Anti-rotation bracket and spout shank assembly provide secure installation to a variety of surfaces both above and below the deck.

5. M•PACT Common Valve System Compatible

Accepts all Moen Roman tub trim kits. 



See [moen.com/customer-support/warranty](https://www.moen.com/customer-support/warranty) for complete product warranty information.

Easily Change Your Style

The Moen® M•PACT® Common Valve System lets you upgrade the style of your faucet or shower as easily as changing a light bulb, saving you time, money and effort.

Little Effort, Big Difference

With an M•PACT compatible fixture, you can upgrade your bath or shower faucets at any time and never touch the plumbing. All changes can be made above the deck or in front of the wall.

- Untwist your current fixture from the top to remove
- Choose any M•PACT style fixture you like
- Lock right into place

Upgrade Anytime

The system is available in a variety of attractive styles and elegant finishes. Change fixtures at any point while decorating, during construction or years down the road.

What Sets Moen Apart?

Our M•PACT Common Valve System allows the homeowner to completely upgrade the style of their lavatory or shower faucet without replacing any of the faucet plumbing.

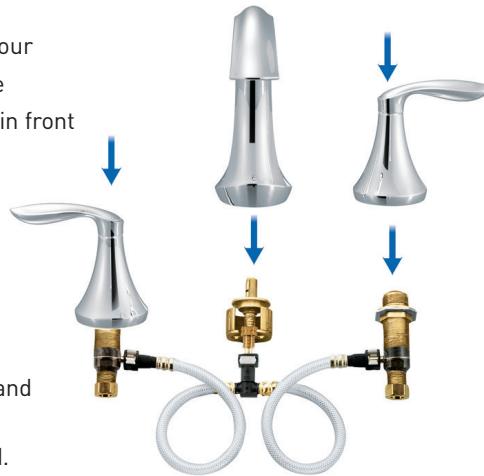

The M•PACT Common Valve System is available in the following applications:

- Widespread lav faucets
- Roman tub faucets
- Wallmount lav faucets
- Tub/shower trim



The M•PACT Common Valve System is compatible with Moen bath and shower faucets featuring this logo.

Save Time With The Pro-Fit® Installation System

The Moen three-step Pro-Fit Installation System is the most innovative, simple way to mount bath accessories. Installation is as easy as 1-2-3.

- 1. DRILL IT!** Use the installation mounting template with built-in level.
- 2. SCREW IT!** Screw in the screw in fastener.
- 3. CLICK IT!** Press on the post until it locks into place.

It really is that simple! Plus, we've eliminated the set screw. Designed with input from professional installers, the Pro-Fit Installation System was made for faster installation and fewer call backs. And of course, there's the extra assurance of quality that comes with the Moen brand. *Available on select collections.*

The Pro-Fit System eliminates set screws for faster, more durable mounting. There's even a template with a built-in level.



YB8081
Pro-Fit Installation Template



DRILL IT! The innovative template has a built-in level for accurate drilling of pilot holes for both 18" and 24" towel bars or paper holders.



SCREW IT! The single-screw mounting system creates a fast and solid installation.





CLICK IT! Locking tab clicks to hold the post firmly in place and eliminates the need for a set screw.



BATH TOUCHLESS FAUCETS





Beautifully blend timeless classics with modern glamour with Flara for a premium aesthetic in the bath.

TOUCHLESS Bath Collection

FLARA™		TOUCHLESS ONE-HANDLE BATHROOM FAUCET - <i>MOTIONSENSE WAVE™</i> - PREMIUM																																																
 <p>DECKPLATE SOLD SEPARATELY</p>	<ul style="list-style-type: none"> • application: one or three hole • supply lines: flexible • connection: 3/8" compression • deckplate: sold separately • drain assembly: metal • drain assembly type: spring loaded pop-up • DC powered: 6 AA batteries included 	<p>1.2 GPM (4.5L/min) max.</p>																																																
			<p> DURALOCK® DURALAST®</p>	<table border="1"> <thead> <tr> <th>MODEL</th> <th>LIST</th> <th>FINISH/CONNECT</th> <th>CASE QTY</th> </tr> </thead> <tbody> <tr> <td>S6981EW</td> <td>1009.30</td> <td>Chrome</td> <td>3</td> </tr> <tr> <td>S6981EWBN</td> <td>1261.60</td> <td>Brushed Nickel</td> <td>3</td> </tr> <tr> <td>S6981EWNL</td> <td>1312.05</td> <td>Polished Nickel</td> <td>3</td> </tr> <tr> <td>S6981EWBG</td> <td>1362.55</td> <td>Brushed Gold</td> <td>3</td> </tr> <tr> <td colspan="4">OPTIONAL DECKPLATE SOLD SEPARATELY</td> </tr> <tr> <td>161919</td> <td>26.35</td> <td>Chrome</td> <td>20</td> </tr> <tr> <td>161919BN</td> <td>37.35</td> <td>Brushed Nickel</td> <td>20</td> </tr> <tr> <td>161919NL</td> <td>37.35</td> <td>Polished Nickel</td> <td>20</td> </tr> <tr> <td>161919BG</td> <td>37.35</td> <td>Brushed Gold</td> <td>20</td> </tr> <tr> <td colspan="4">OPTIONAL AC ADAPTERS SOLD SEPARATELY</td> </tr> <tr> <td>169031</td> <td>156.45</td> <td>N/A or Unfinished</td> <td>12</td> </tr> </tbody> </table>	MODEL	LIST	FINISH/CONNECT	CASE QTY	S6981EW	1009.30	Chrome	3	S6981EWBN	1261.60	Brushed Nickel	3	S6981EWNL	1312.05	Polished Nickel	3	S6981EWBG	1362.55	Brushed Gold	3	OPTIONAL DECKPLATE SOLD SEPARATELY				161919	26.35	Chrome	20	161919BN	37.35	Brushed Nickel	20	161919NL	37.35	Polished Nickel	20	161919BG	37.35	Brushed Gold	20	OPTIONAL AC ADAPTERS SOLD SEPARATELY				169031	156.45
MODEL	LIST	FINISH/CONNECT	CASE QTY																																															
S6981EW	1009.30	Chrome	3																																															
S6981EWBN	1261.60	Brushed Nickel	3																																															
S6981EWNL	1312.05	Polished Nickel	3																																															
S6981EWBG	1362.55	Brushed Gold	3																																															
OPTIONAL DECKPLATE SOLD SEPARATELY																																																		
161919	26.35	Chrome	20																																															
161919BN	37.35	Brushed Nickel	20																																															
161919NL	37.35	Polished Nickel	20																																															
161919BG	37.35	Brushed Gold	20																																															
OPTIONAL AC ADAPTERS SOLD SEPARATELY																																																		
169031	156.45	N/A or Unfinished	12																																															

DOUX™		TOUCHLESS ONE-HANDLE BATHROOM FAUCET - <i>MOTIONSENSE WAVE™</i> - PREMIUM																								
 <p>DECKPLATE INCLUDED</p>	<ul style="list-style-type: none"> • application: one or three hole • supply lines: flexible • connection: 3/8" compression • deckplate: included • drain assembly: metal • drain assembly type: spring loaded pop-up • DC powered: 6 AA batteries included 	<p>1.2 GPM (4.5L/min) max.</p>																								
			<p> DURALOCK® DURALAST®</p>	<table border="1"> <thead> <tr> <th>MODEL</th> <th>LIST</th> <th>FINISH/CONNECT</th> <th>CASE QTY</th> </tr> </thead> <tbody> <tr> <td>S6910EW</td> <td>825.90</td> <td>Chrome</td> <td>3</td> </tr> <tr> <td>S6910EWBN</td> <td>1060.80</td> <td>Brushed Nickel</td> <td>3</td> </tr> <tr> <td>S6910EWBL</td> <td>1156.25</td> <td>Matte Black</td> <td>3</td> </tr> <tr> <td colspan="4">OPTIONAL AC ADAPTERS SOLD SEPARATELY</td> </tr> <tr> <td>169031</td> <td>156.45</td> <td>N/A or Unfinished</td> <td>12</td> </tr> </tbody> </table>	MODEL	LIST	FINISH/CONNECT	CASE QTY	S6910EW	825.90	Chrome	3	S6910EWBN	1060.80	Brushed Nickel	3	S6910EWBL	1156.25	Matte Black	3	OPTIONAL AC ADAPTERS SOLD SEPARATELY				169031	156.45
MODEL	LIST	FINISH/CONNECT	CASE QTY																							
S6910EW	825.90	Chrome	3																							
S6910EWBN	1060.80	Brushed Nickel	3																							
S6910EWBL	1156.25	Matte Black	3																							
OPTIONAL AC ADAPTERS SOLD SEPARATELY																										
169031	156.45	N/A or Unfinished	12																							

CIA™		TOUCHLESS ONE-HANDLE BATHROOM FAUCET - <i>MOTIONSENSE WAVE™</i>																												
 <p>DECKPLATE INCLUDED</p>	<ul style="list-style-type: none"> • application: one or three hole • supply lines: flexible • connection: 3/8" compression • deckplate: included • drain assembly: metal • drain assembly type: spring loaded pop-up • red/blue markings: included • matte black faucet includes optional brushed gold escutcheon • DC powered: 6 AA batteries included 	<p>1.2 GPM (4.5L/min) max.</p>																												
			<p> DURALOCK® DURALAST®</p>	<table border="1"> <thead> <tr> <th>MODEL</th> <th>LIST</th> <th>FINISH/CONNECT</th> <th>CASE QTY</th> </tr> </thead> <tbody> <tr> <td>6221EW</td> <td>627.70</td> <td>Chrome</td> <td>3</td> </tr> <tr> <td>6221EWBN</td> <td>847.40</td> <td>Brushed Nickel</td> <td>3</td> </tr> <tr> <td>6221EWBG</td> <td>910.15</td> <td>Brushed Gold</td> <td>3</td> </tr> <tr> <td>6221EWBL</td> <td>910.15</td> <td>Matte Black</td> <td>3</td> </tr> <tr> <td colspan="4">OPTIONAL AC ADAPTERS SOLD SEPARATELY</td> </tr> <tr> <td>169031</td> <td>156.45</td> <td>N/A or Unfinished</td> <td>12</td> </tr> </tbody> </table>	MODEL	LIST	FINISH/CONNECT	CASE QTY	6221EW	627.70	Chrome	3	6221EWBN	847.40	Brushed Nickel	3	6221EWBG	910.15	Brushed Gold	3	6221EWBL	910.15	Matte Black	3	OPTIONAL AC ADAPTERS SOLD SEPARATELY				169031	156.45
MODEL	LIST	FINISH/CONNECT	CASE QTY																											
6221EW	627.70	Chrome	3																											
6221EWBN	847.40	Brushed Nickel	3																											
6221EWBG	910.15	Brushed Gold	3																											
6221EWBL	910.15	Matte Black	3																											
OPTIONAL AC ADAPTERS SOLD SEPARATELY																														
169031	156.45	N/A or Unfinished	12																											



TOUCHLESS BATH







BATH AND SHOWERING





WEYMOUTH® Collection

MODEL LIST FINISH/CONNECT CASE QTY

ONE-HANDLE BATHROOM FAUCET - PREMIUM				
 <ul style="list-style-type: none"> • application: one hole • supply lines: flexible • connection: 3/8" compression • drain assembly: metal • drain assembly type: spring loaded pop-up <p> DURALAST®</p>	<p> 1.2 GPM (4.5L/min) max.</p>			
	S42107	780.10	Chrome	3
	S42107BN	1092.15	Brushed Nickel	3
	S42107BL	1131.15	Matte Black	3
	S42107BG	1209.20	Brushed Gold	3
	S42107NL	1170.15	Polished Nickel	3
	S42107ORB	1209.20	Oil Rubbed Bronze	3

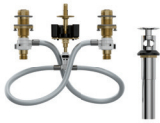
TWO-HANDLE WIDESPREAD BATHROOM FAUCET TRIM - PREMIUM				
 <ul style="list-style-type: none"> • application: three hole • center dimensions: 8" - 16" center • drain assembly: metal with lift rod • valve: sold separately <p> </p>	<p> 1.2 GPM (4.5L/min) max.</p>			
	TS42108	828.20	Chrome	3
	TS42108BN	1118.05	Brushed Nickel	3
	TS42108BL	1159.45	Matte Black	3
	TS42108BG	1242.25	Brushed Gold	3
	TS42108NL	1200.85	Polished Nickel	3
	TS42108ORB	1242.25	Oil Rubbed Bronze	3
 <ul style="list-style-type: none"> • application: three hole • center dimensions: 8" - 16" center • drain assembly: metal with lift rod • valve: sold separately <p></p>	<p> 1.2 GPM (4.5L/min) max.</p>			
	TS42114	828.20	Chrome	3
	TS42114BN	1118.05	Brushed Nickel	3
	TS42114BL	1159.45	Matte Black	3
	TS42114BG	1283.70	Brushed Gold	3
	TS42114NL	1200.85	Polished Nickel	3
	TS42114ORB	1242.25	Oil Rubbed Bronze	3

WIDESPREAD FAUCET VALVE				
 <ul style="list-style-type: none"> • application: three hole • center dimensions: 8" - 16" center • drain assembly: metal with lift rod <p> DURALOCK® DURALAST®</p>	9000◆	162.15	1/2" IPS	6











HOW TO ORDER
VALVES: PAGE 463

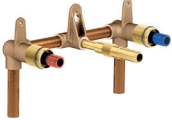









 TRIM PART # +  VALVE PART # =  COMPLETE FAUCET

OPTION: HANDLE CAP KIT				
 <ul style="list-style-type: none"> • description: finished handle cap kit • language: english version only 	221672	26.95	Chrome	12
	221672BN	35.80	Brushed Nickel	12
	221672BL	39.60	Matte Black	12
	221672BG	35.80	Brushed Gold	12
	221672NL	35.80	Polished Nickel	12
	221672ORB	39.60	Oil Rubbed Bronze	12

















WEYMOUTH® Collection

		MODEL	LIST	FINISH/CONNECT	CASE QTY
TWO-HANDLE WALLMOUNT BATHROOM FAUCET TRIM - PREMIUM					
 <ul style="list-style-type: none"> • application: three hole • center dimensions: 8" center • drain assembly: 140780 sold separately • valve: sold separately 		1.2 GPM (4.5L/min) max.			
		TS42112	847.50	Chrome	3
		TS42112BN	1101.70	Brushed Nickel	3
		TS42112BL	1144.10	Matte Black	3
		TS42112NL	1186.45	Polished Nickel	3
		TS42112BG	1228.85	Brushed Gold	3
TS42112ORB	1228.85	Oil Rubbed Bronze	3		
TWO-HANDLE WALLMOUNT FAUCET VALVE					
 <ul style="list-style-type: none"> • application: three hole • center dimensions: 8" center • drain assembly: 140780 sold separately • includes: mounting brackets 	 DURALAST®	9700	229.35	1/2" CC	3
		<p>HOW TO ORDER VALVES: PAGE 463</p>  TRIM PART #   VALVE PART #   COMPLETE FAUCET			
OPTION: HANDLE CAP KIT					
 <ul style="list-style-type: none"> • description: finished handle cap kit • language: english version only 		221672	26.95	Chrome	12
		221672BN	35.80	Brushed Nickel	12
		221672BL	39.60	Matte Black	12
		221672NL	35.80	Polished Nickel	12
		221672BG	35.80	Brushed Gold	12
		221672ORB	39.60	Oil Rubbed Bronze	12
OPTION: DRAIN ASSEMBLY					
 <ul style="list-style-type: none"> • drain assembly: metal • drain assembly type: spring loaded pop-up • drain assembly size: 1-1/4" • drain assembly: 1-1/4" non-overflow 		140780	76.80	Chrome	12
		140780BN	107.05	Brushed Nickel	12
		140780BL	120.90	Matte Black	12
		140780NL	107.05	Polished Nickel	12
		140780BG	107.05	Brushed Gold	12
		140780ORB	128.75	Oil Rubbed Bronze	12









		MODEL	LIST	FINISH/CONNECT	CASE QTY
FREESTANDING OR WALLMOUNT TUB FILLER TRIM - PREMIUM					
 <ul style="list-style-type: none"> • application: two hole • center dimensions: 8" center • connection: 3/4" male • showerhead type: handshower • handshower functions: one-function • handshower flow rate: 1.75 gpm (6.65 L/min) max. • spout reach: 9.00" • mounting kit: sold separately 		S22105	2322.25	Chrome	1
		S22105BN	3367.30	Brushed Nickel	1
	Q3 NEW!	S22105BL	3483.35	Matte Black	1
	Q3 NEW!	S22105NL	3599.50	Polished Nickel	1
	Q3 NEW!	S22105BG	3715.60	Brushed Gold	1
		S22105ORB	3715.60	Oil Rubbed Bronze	1
	DURALAST®				
 <ul style="list-style-type: none"> • application: two hole • center dimensions: 8" center • connection: 3/4" male • showerhead type: handshower • handshower functions: one-function • handshower flow rate: 1.75 gpm (6.65 L/min) max. • spout reach: 9.00" • mounting kit: sold separately 		S22110	2322.25	Chrome	1
		S22110BN	3367.30	Brushed Nickel	1
	Q3 NEW!	S22110BL	3483.35	Matte Black	1
	Q3 NEW!	S22110NL	3599.50	Polished Nickel	1
	Q3 NEW!	S22110BG	3715.60	Brushed Gold	1
		S22110ORB	3715.60	Oil Rubbed Bronze	1
	DURALAST®				
 <ul style="list-style-type: none"> • description: floor mount tub filler risers • application: two hole • connection: 3/4" male • requires: floor mounting kit • fits: S22105 and S22100 		TS25105	968.90	Chrome	1
		TS25105BN	1404.75	Brushed Nickel	1
	Q3 NEW!	TS25105BL	1453.35	Matte Black	1
	Q3 NEW!	TS25105NL	1501.80	Polished Nickel	1
	Q3 NEW!	TS25105BG	1550.25	Brushed Gold	1
	TS25105ORB	1545.25	Oil Rubbed Bronze	1	
	DURALAST®				
FREESTANDING TUB FILLER VALVE AND MOUNTING KIT - PREMIUM					
 <ul style="list-style-type: none"> • description: double riser floor joist mounting kit • application: two hole with 8" centers • center dimensions: 		TS50200	601.45	1/2" CC, NPT	2
		DURALAST®			
 <ul style="list-style-type: none"> • description: double riser concrete mounting kit • application: two hole with 8" centers • quarter turn stops: included 		TS50210	488.90	1/2" CC, NPT	2
		DURALAST®			
<p>HOW TO ORDER VALVES: PAGE 463</p>  TRIM PART # +  RISER PART # +  VALVE PART # =  COMPLETE FAUCET					
OPTION: DIVERTER HANDLE CAP KIT					
 <ul style="list-style-type: none"> • description: finished diverter handle cap kit 		221772	17.30	Chrome	12
		221772BN	22.95	Brushed Nickel	12
		221772BL	24.40	Matte Black	12
		221772NL	24.25	Polished Nickel	12
		221772BG	24.25	Brushed Gold	12
		221772ORB	25.25	Oil Rubbed Bronze	12
OPTION: HANDLE CAP KIT					
 <ul style="list-style-type: none"> • description: finished handle cap kit • language: english version only 		221672	26.95	Chrome	12
		221672BN	35.80	Brushed Nickel	12
		221672BL	39.60	Matte Black	12
		221672NL	35.80	Polished Nickel	12
		221672BG	35.80	Brushed Gold	12
		221672ORB	39.60	Oil Rubbed Bronze	12









WEYMOUTH® Collection

	MODEL	LIST	FINISH/CONNECT	CASE QTY
TWO-HANDLE ROMAN TUB TRIM - PREMIUM				
 <ul style="list-style-type: none"> • application: three hole • spout reach: 8.10" • valve: sold separately 	TS22101	1140.80	Chrome	3
	TS22101BN	1614.60	Brushed Nickel	3
	TS22101NL	1614.60	Polished Nickel	3
	TS22101BG	1614.60	Brushed Gold	3
	TS22101BL	1742.00	Matte Black	3
	TS22101ORB	1742.00	Oil Rubbed Bronze	3
 <ul style="list-style-type: none"> • application: three hole • spout reach: 8.10" • valve: sold separately 	TS22103	1140.80	Chrome	3
	TS22103BN	1614.60	Brushed Nickel	3
	TS22103NL	1614.60	Polished Nickel	3
	TS22103BG	1614.60	Brushed Gold	3
	TS22103BL	1742.00	Matte Black	3
	TS22103ORB	1742.00	Oil Rubbed Bronze	3
TWO-HANDLE ROMAN TUB TRIM WITH HANDSHOWER - PREMIUM				
 <ul style="list-style-type: none"> • application: four hole • showerhead type: handshower • handshower flow rate: 1.75 gpm (6.65 L/min) max. • spray functions: one-function • spout reach: 8.10" • valve: sold separately 	TS21102	1739.20	Chrome	3
	TS21102BN	3027.40	Brushed Nickel	3
	TS21102NL	3027.40	Polished Nickel	3
	TS21102BG	3027.40	Brushed Gold	3
	TS21102BL	3266.30	Matte Black	3
	TS21102ORB	3266.30	Oil Rubbed Bronze	3
 <ul style="list-style-type: none"> • application: four hole • showerhead type: handshower • handshower flow rate: 1.75 gpm (6.65 L/min) max. • spray functions: one-function • spout reach: 8.10" • valve: sold separately 	TS21104	1739.20	Chrome	3
	TS21104BN	3027.40	Brushed Nickel	3
	TS21104NL	3027.40	Polished Nickel	3
	TS21104BG	3027.40	Brushed Gold	3
	TS21104BL	3266.30	Matte Black	3
	TS21104ORB	3266.30	Oil Rubbed Bronze	3
TWO-HANDLE ROMAN TUB VALVE				
 <ul style="list-style-type: none"> • deck thickness: 1/8" to 3-3/8" rough-in deck • adjustable spout shank: adjustable center dimensions 	4792	188.55	1/2" CC	6
	DURALAST®			
 <ul style="list-style-type: none"> • deck thickness: 1/8" to 2-3/4" rough-in deck • adjustable spout shank: 10" - 24" center dimensions 	4793	213.55	1/2" CPVC, Crimp Ring PEX	6
	4794	203.60	1/2" Crimp Ring PEX, Cold Exp. PEX	6
DURALOCK® DURALAST®				
 <ul style="list-style-type: none"> • deck thickness: 1/8" to 3-3/16" rough-in deck • Non-adjustable spout shank: 10" center dimensions 	4796	177.65	1/2" CC	6
	4797	181.10	1/2" CPVC, Crimp Ring PEX	6
	4798	181.10	1/2" Crimp Ring PEX, Cold Exp. PEX	6
DURALAST®				
TWO-HANDLE ROMAN TUB VALVE WITH HANDSHOWER				
 <ul style="list-style-type: none"> • deck thickness: 1/8" to 2-5/8" rough-in deck • non-adj spout shank: adjustable center dim's 	9792	424.85	1/2" CC	6
	DURALAST®			
 <ul style="list-style-type: none"> • deck thickness: 1/8" to 2-5/8" rough-in deck • adj spout shank: 10" - 24" center dimensions 	9793	434.80	1/2" CPVC, Crimp Ring PEX	6
	DURALOCK® DURALAST®			
For more product details, reference page 464 in valve section.				
HOW TO ORDER VALVES: PAGE 464  TRIM PART #   VALVE PART #   COMPLETE FAUCET				
OPTION: HANDLE CAP KIT				
 <ul style="list-style-type: none"> • description: finished handle cap kit • language: english version only 	221672	26.95	Chrome	12
	221672BN	35.80	Brushed Nickel	12
	221672NL	35.80	Polished Nickel	12
	221672BG	35.80	Brushed Gold	12
	221672BL	39.60	Matte Black	12
	221672ORB	39.60	Oil Rubbed Bronze	12



















WEYMOUTH®

WEYMOUTH® Collection

		MODEL	LIST	FINISH/CONNECT	CASE QTY
EXACTTEMP® VALVE ONLY TRIM - PREMIUM					
 <ul style="list-style-type: none"> • description: temperature control valve trim • requires: separate volume control valve • valve: sold separately  		TS32110	486.25	Chrome	3
		TS32110BN	715.70	Brushed Nickel	3
		TS32110NL	715.70	Polished Nickel	3
		TS32110BG	715.70	Brushed Gold	3
		TS32110BL	772.05	Matte Black	3
		TS32110ORB	772.05	Oil Rubbed Bronze	3
EXACTTEMP® THERMOSTATIC MIXING SHOWER VALVE - PREMIUM					
 <ul style="list-style-type: none"> • description: thermostatic rough-in valve • ports: four with adjustable temp. limit stops • check stops: included 		S3371	714.65	¾" IPS	6
<p>HOW TO ORDER VALVES: PAGE 465</p>  TRIM PART # +  VALVE PART # =  COMPLETE FAUCET					
OPTION: HANDLE CAP KIT					
 <ul style="list-style-type: none"> • description: finished handle cap kit • language: english version only 		221672	26.95	Chrome	12
		221672BN	35.80	Brushed Nickel	12
		221672NL	35.80	Polished Nickel	12
		221672BG	35.80	Brushed Gold	12
		221672BL	39.60	Matte Black	12
		221672ORB	39.60	Oil Rubbed Bronze	12



















EXACTTEMP® VOLUME CONTROL VALVE TRIM - PREMIUM					
 <ul style="list-style-type: none"> • valve: sold separately  		TS52104	252.45	Chrome	6
		TS52104BN	348.75	Brushed Nickel	6
		TS52104NL	348.75	Polished Nickel	6
		TS52104BG	348.75	Brushed Gold	6
		TS52104BL	376.05	Matte Black	6
		TS52104ORB	376.05	Oil Rubbed Bronze	6
EXACTTEMP® VOLUME CONTROL SHOWER VALVE - PREMIUM					
 <ul style="list-style-type: none"> • includes: volume control 		S3600	181.70	¾" IPS	12
<p>HOW TO ORDER VALVES: PAGE 465</p>  TRIM PART # +  VALVE PART # =  COMPLETE FAUCET					
OPTION: HANDLE CAP KIT					
 <ul style="list-style-type: none"> • description: finished handle cap kit • language: english version only 		221672	26.95	Chrome	12
		221672BN	35.80	Brushed Nickel	12
		221672NL	35.80	Polished Nickel	12
		221672BG	35.80	Brushed Gold	12
		221672BL	39.60	Matte Black	12
		221672ORB	39.60	Oil Rubbed Bronze	12

WEYMOUTH® Collection

		MODEL	LIST	FINISH/CONNECT	CASE QTY
M-CORE® 4-SERIES TUB/SHOWER TRIM - PREMIUM					
	<ul style="list-style-type: none"> • showerhead: two-function eco-performance rainshower • showerhead size: 9" diameter • tub spout length: 6 3/4" • tub spout connection type: slip fit • tub spout type: diverter • includes: thermostatic cartridge with volume and temperature control • valve: sold separately 	1.75 GPM (6.65 L/min) max.			
		UTS43103EP	1192.05	Chrome	3
		UTS43103EPBN	1584.80	Brushed Nickel	3
		UTS43103EPNL	1584.80	Polished Nickel	3
		UTS43103EPBG	1584.80	Brushed Gold	3
		UTS43103EPBL	1731.85	Matte Black	3
		UTS43103EPORB	1731.85	Oil Rubbed Bronze	3
M-CORE® 4-SERIES SHOWER ONLY TRIM - PREMIUM					
	<ul style="list-style-type: none"> • showerhead: two-function eco-performance rainshower • showerhead size: 9" diameter • includes: thermostatic cartridge with volume and temperature control • valve: sold separately 	1.75 GPM (6.65 L/min) max.			
		UTS43102EP	1057.20	Chrome	3
		UTS43102EPBN	1415.85	Brushed Nickel	3
		UTS43102EPNL	1415.85	Polished Nickel	3
		UTS43102EPBG	1415.85	Brushed Gold	3
		UTS43102EPBL	1543.75	Matte Black	3
		UTS43102EPORB	1543.75	Oil Rubbed Bronze	3
M-CORE® 4-SERIES VALVE ONLY TRIM - PREMIUM					
	<ul style="list-style-type: none"> • includes: thermostatic cartridge with volume and temperature control • valve: sold separately 	UTS43101	750.75	Chrome	3
		UTS43101BN	925.40	Brushed Nickel	3
		UTS43101NL	925.40	Polished Nickel	3
		UTS43101BG	925.40	Brushed Gold	3
		UTS43101BL	973.50	Matte Black	3
		UTS43101ORB	973.50	Oil Rubbed Bronze	3
M-CORE® MIXING SHOWER VALVE					
	<ul style="list-style-type: none"> • tub/shower or shower only application • ports: four with adj. temp. limit stops • included: test plug and cross flow plug 	U140CI	71.20	1/2" CC/IPS	6
		U140X	71.20	1/2" Crimp Ring PEX + CC/IPS Tub	6
		U140CX	71.20	1/2" Cold Exp. PEX + CC/IPS Tub	6
		U140V	87.20	1/2" CPVC + CC/IPS Tub	6
	<ul style="list-style-type: none"> • tub/shower or shower only application • ports: four with adj. temp. limit stops • quarter turn stops: included 	U140CIS	102.45	1/2" CC/IPS	6
		U140XS	102.45	1/2" Crimp Ring PEX + CC/IPS Tub	6
		U140CXS	102.45	1/2" Cold Exp. PEX + CC/IPS Tub	6
		U140VS	118.50	1/2" CPVC + CC/IPS Tub	6
	<ul style="list-style-type: none"> • tub/shower only application • ports: four with adj. temp. limit stops • tub outlet: pre-fabricated 1/2" copper tube • included: quarter turn stops and plugs 	U140X-PF	80.40	1/2" Crimp Ring PEX	6
		U140CX-PF	80.40	1/2" Cold Exp. PEX	6
	<ul style="list-style-type: none"> • tub/shower only application • ports: four with adj. temp. limit stops • tub outlet: pre-fabricated 1/2" copper tube • included: quarter turn stops and plugs 	U140XS-PF	111.70	1/2" Crimp Ring PEX	6
		U140CXS-PF	111.70	1/2" Cold Exp. PEX	6
	<ul style="list-style-type: none"> • shower only application • ports: three 	U130CI	71.20	1/2" CC/IPS	6
		U130X	71.20	1/2" Crimp Ring PEX	6
		U130CX	71.20	1/2" Cold Exp. PEX	6
	<ul style="list-style-type: none"> • shower only application • ports: three • quarter turn stops: included 	U130CIS	102.45	1/2" CC/IPS	6
		U130XS	102.45	1/2" Crimp Ring PEX	6
		U130CXS	102.45	1/2" Cold Exp. PEX	6
<p>Four port valves can be used with either Tub/Shower or Shower Only applications. Three port valves can ONLY be used with Shower Only applications. For more product details, reference pages 465-466 in valve section.</p>					
<p>HOW TO ORDER VALVES: PAGES 465-466</p>					



















WEYMOUTH®









MODEL LIST FINISH/CONNECT CASE QTY









M-CORE® 3-SERIES TUB/SHOWER TRIM - PREMIUM					
 <ul style="list-style-type: none"> • showerhead: two-function rainshower • showerhead size: 9" diameter • tub spout length: 6 3/4" • tub spout connection type: slip fit • tub spout type: diverter • includes: pressure balanced cartridge with volume and temperature control • valve: sold separately 	<p>2.5 GPM (9.5 L/min) max.</p>				
	UTS33103	1057.05	Chrome	3	
	UTS33103BN	1449.80	Brushed Nickel	3	
	UTS33103NL	1449.80	Polished Nickel	3	
	UTS33103BG	1449.80	Brushed Gold	3	
	UTS33103BL	1596.85	Matte Black	3	
	UTS33103ORB	1596.85	Oil Rubbed Bronze	3	
	1.75 GPM (6.65 L/min) max.				
	UTS33103EP	1057.05	Chrome	3	
	UTS33103EPBN	1449.80	Brushed Nickel	3	
	UTS33103EPNL	1449.80	Polished Nickel	3	
	UTS33103EPBG	1449.80	Brushed Gold	3	
	UTS33103EPBL	1596.85	Matte Black	3	
UTS33103EPORB	1596.85	Oil Rubbed Bronze	3		
M-CORE® 3-SERIES SHOWER ONLY TRIM - PREMIUM					
 <ul style="list-style-type: none"> • showerhead: two-function rainshower • showerhead size: 9" diameter • includes: pressure balanced cartridge with volume and temperature control • valve: sold separately 	<p>2.5 GPM (9.5 L/min) max.</p>				
	UTS33102	922.20	Chrome	3	
	UTS33102BN	1280.85	Brushed Nickel	3	
	UTS33102NL	1280.85	Polished Nickel	3	
	UTS33102BG	1280.85	Brushed Gold	3	
	UTS33102BL	1408.75	Matte Black	3	
	UTS33102ORB	1408.75	Oil Rubbed Bronze	3	
	1.75 GPM (6.65 L/min) max.				
	UTS33102EP	922.20	Chrome	3	
	UTS33102EPBN	1280.85	Brushed Nickel	3	
	UTS33102EPNL	1280.85	Polished Nickel	3	
	UTS33102EPBG	1280.85	Brushed Gold	3	
	UTS33102EPBL	1408.75	Matte Black	3	
UTS33102EPORB	1408.75	Oil Rubbed Bronze	3		
M-CORE® MIXING SHOWER VALVE					
 <ul style="list-style-type: none"> • tub/shower or shower only application • ports: four with adj. temp. limit stops • included: test plug and cross flow plug 	U140CI	71.20	1/2" CC/IPS	6	
		U140X	71.20	1/2" Crimp Ring PEX + CC/IPS Tub	6
		U140CX	71.20	1/2" Cold Exp. PEX + CC/IPS Tub	6
		U140V	87.20	1/2" CPVC + CC/IPS Tub	6
 <ul style="list-style-type: none"> • tub/shower or shower only application • ports: four with adj. temp. limit stops • quarter turn stops: included 	U140CIS	102.45	1/2" CC/IPS	6	
		U140XS	102.45	1/2" Crimp Ring PEX + CC/IPS Tub	6
		U140CXS	102.45	1/2" Cold Exp. PEX + CC/IPS Tub	6
		U140VS	118.50	1/2" CPVC + CC/IPS Tub	6
 <ul style="list-style-type: none"> • tub/shower only application • ports: four with adj. temp. limit stops • tub outlet: pre-fabricated 1/2" copper tube • included: quarter turn stops and plugs 	U140X-PF	80.40	1/2" Crimp Ring PEX	6	
		U140CX-PF	80.40	1/2" Cold Exp. PEX	6
 <ul style="list-style-type: none"> • tub/shower only application • ports: four with adj. temp. limit stops • tub outlet: pre-fabricated 1/2" copper tube • included: quarter turn stops and plugs 	U140XS-PF	111.70	1/2" Crimp Ring PEX	6	
		U140CXS-PF	111.70	1/2" Cold Exp. PEX	6
 <ul style="list-style-type: none"> • shower only application • ports: three 	U130CI	71.20	1/2" CC/IPS	6	
		U130X	71.20	1/2" Crimp Ring PEX	6
		U130CX	71.20	1/2" Cold Exp. PEX	6
 <ul style="list-style-type: none"> • shower only application • ports: three • quarter turn stops: included 	U130CIS	102.45	1/2" CC/IPS	6	
		U130XS	102.45	1/2" Crimp Ring PEX	6
		U130CXS	102.45	1/2" Cold Exp. PEX	6
<p>Four port valves can be used with either Tub/Shower or Shower Only applications. Three port valves can ONLY be used with Shower Only applications. For more product details, reference pages 465-466 in valve section.</p>					
<p>HOW TO ORDER VALVES: PAGES 465-466</p>	 <p>TRIM PART #</p>	<p>+</p>	 <p>VALVE PART #</p>	<p>=</p>	 <p>COMPLETE FAUCET</p>





























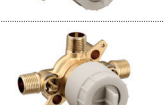

WEYMOUTH® Collection

		MODEL	LIST	FINISH/CONNECT	CASE QTY
M-CORE® 3-SERIES VALVE ONLY TRIM - PREMIUM					
 <ul style="list-style-type: none"> • includes: pressure balanced cartridge with volume and temperature control • valve: sold separately 	 	UTS33101	615.75	Chrome	3
		UTS33101BN	790.40	Brushed Nickel	3
		UTS33101NL	790.40	Polished Nickel	3
		UTS33101BG	790.40	Brushed Gold	3
		UTS33101BL	838.50	Matte Black	3
		UTS33101ORB	838.50	Oil Rubbed Bronze	3
M-CORE® MIXING SHOWER VALVE					
 <ul style="list-style-type: none"> • tub/shower or shower only application • ports: four with adj. temp. limit stops • included: test plug and cross flow plug 		U140CI	71.20	1/2" CC/IPS	6
		U140X	71.20	1/2" Crimp Ring PEX + CC/IPS Tub	6
		U140CX	71.20	1/2" Cold Exp. PEX + CC/IPS Tub	6
		U140V	87.20	1/2" CPVC + CC/IPS Tub	6
 <ul style="list-style-type: none"> • tub/shower or shower only application • ports: four with adj. temp. limit stops • quarter turn stops: included 		U140CIS	102.45	1/2" CC/IPS	6
		U140XS	102.45	1/2" Crimp Ring PEX + CC/IPS Tub	6
		U140CXS	102.45	1/2" Cold Exp. PEX + CC/IPS Tub	6
		U140VS	118.50	1/2" CPVC + CC/IPS Tub	6
 <ul style="list-style-type: none"> • tub/shower only application • ports: four with adj. temp. limit stops • tub outlet: pre-fabricated 1/2" copper tube • included: quarter turn stops and plugs 		U140X-PF	80.40	1/2" Crimp Ring PEX	6
		U140CX-PF	80.40	1/2" Cold Exp. PEX	6
 <ul style="list-style-type: none"> • tub/shower only application • ports: four with adj. temp. limit stops • tub outlet: pre-fabricated 1/2" copper tube • included: quarter turn stops and plugs 		U140XS-PF	111.70	1/2" Crimp Ring PEX	6
		U140CXS-PF	111.70	1/2" Cold Exp. PEX	6
 <ul style="list-style-type: none"> • shower only application • ports: three 		U130CI	71.20	1/2" CC/IPS	6
		U130X	71.20	1/2" Crimp Ring PEX	6
		U130CX	71.20	1/2" Cold Exp. PEX	6
 <ul style="list-style-type: none"> • shower only application • ports: three • quarter turn stops: included 		U130CIS	102.45	1/2" CC/IPS	6
		U130XS	102.45	1/2" Crimp Ring PEX	6
		U130CXS	102.45	1/2" Cold Exp. PEX	6
<p>Four port valves can be used with either Tub/Shower or Shower Only applications. Three port valves can ONLY be used with Shower Only applications. For more product details, reference pages 465-466 in valve section.</p>					
<p>HOW TO ORDER VALVES: PAGES 465-466</p>	 <p>TRIM PART #</p>	+	 <p>VALVE PART #</p>	=	 <p>COMPLETE FAUCET</p>

		MODEL	LIST	FINISH/CONNECT	CASE QTY			
M-CORE® 3-SERIES WITH INTEGRATED TRANSFER VALVE TRIM - PREMIUM								
 <ul style="list-style-type: none"> includes: pressure balanced cartridge with volume and temperature control valve: sold separately 		UTS4311	738.70	Chrome	4			
		UTS4311BN	1071.10	Brushed Nickel	4			
		UTS4311NL	1071.10	Polished Nickel	4			
		UTS4311BG	1071.10	Brushed Gold	4			
		UTS4311BL	1178.20	Matte Black	4			
		UTS4311ORB	1178.20	Oil Rubbed Bronze	4			
M-CORE® WITH INTEGRATED TRANSFER VALVE								
Three Function (2 independent/1 shared) OR Six Function (3 independent/3 shared) - plumbing configuration page 472								
 <ul style="list-style-type: none"> ports: four with adj. temp. limit stops check stops: included 		U362CIS	265.40	1/2" CC/IPS	6			
		U362CXS	265.40	1/2" Cold Exp. PEX	6			
		U362XS	265.40	1/2" Crimp Ring PEX	6			
Two Independent Functions OR Three Independent Functions - plumbing configurations page 472								
 <ul style="list-style-type: none"> ports: four with adj. temp. limit stops check stops: included 		U232CIS	265.40	1/2" CC/IPS	6			
		U232CXS	265.40	1/2" Cold Exp. PEX	6			
		U232XS	265.40	1/2" Crimp Ring PEX	6			
For more product details, reference page 466 in valve section. See page 472 for plumbing configurations.								
HOW TO ORDER VALVES: PAGE 466		TRIM PART #	+		VALVE PART #	=		COMPLETE FAUCET

















M-CORE® TRANSFER VALVE TRIM - PREMIUM								
 <ul style="list-style-type: none"> use with the M-CORE® transfer valve valve: sold separately 		UTS32205	459.95	Chrome	12			
		UTS32205BN	525.60	Brushed Nickel	12			
		UTS32205NL	525.60	Polished Nickel	12			
		UTS32205BG	525.60	Brushed Gold	12			
		UTS32205BL	559.50	Matte Black	12			
		UTS32205ORB	559.50	Oil Rubbed Bronze	12			
M-CORE® TRANSFER VALVE								
Three Function (2 independent/1 shared) OR Six Function (3 independent/3 shared) - plumbing configuration page 472								
 <ul style="list-style-type: none"> number of functions: three or six ports: four 		U361CI	149.70	1/2" CC/IPS	6			
		U361CX	149.70	1/2" Cold Exp. PEX	6			
		U361X	149.70	1/2" Crimp Ring PEX	6			
Two Independent Functions OR Three Independent Functions - plumbing configurations page 472								
 <ul style="list-style-type: none"> number of functions: two or three ports: four 		U231CI	149.70	1/2" CC/IPS	6			
		U231CX	149.70	1/2" Cold Exp. PEX	6			
		U231X	149.70	1/2" Crimp Ring PEX	6			
For more product details, reference page 466 in valve section. See page 472 for plumbing configurations.								
HOW TO ORDER VALVES: PAGE 466		TRIM PART #	+		VALVE PART #	=		COMPLETE FAUCET

WEYMOUTH® Collection

		MODEL	LIST	FINISH/CONNECT	CASE QTY
M-CORE® 2-SERIES TUB/SHOWER TRIM - PREMIUM					
 <ul style="list-style-type: none"> • showerhead: two-function eco-performance rainshower • showerhead size: 9" diameter • tub spout length: 6 3/4" • tub spout connection type: slip fit • tub spout type: diverter • includes: pressure balanced cartridge with temperature control • valve: sold separately 	<ul style="list-style-type: none"> • showerhead: two-function eco-performance rainshower • showerhead size: 9" diameter • includes: pressure balanced cartridge with temperature control • valve: sold separately 	1.75 GPM (6.65 L/min) max.			
		UTS232104EP	1047.80	Chrome	3
		UTS232104EPBN	1424.65	Brushed Nickel	3
		UTS232104EPNL	1424.65	Polished Nickel	3
		UTS232104EPBG	1424.65	Brushed Gold	3
		UTS232104EPBL	1528.25	Matte Black	3
UTS232104EPORB	1528.25	Oil Rubbed Bronze	3		
M-CORE® 2-SERIES SHOWER ONLY TRIM - PREMIUM					
 <ul style="list-style-type: none"> • showerhead: two-function eco-performance rainshower • showerhead size: 9" diameter • includes: pressure balanced cartridge with temperature control • valve: sold separately 	<ul style="list-style-type: none"> • showerhead: two-function eco-performance rainshower • showerhead size: 9" diameter • includes: pressure balanced cartridge with temperature control • valve: sold separately 	1.75 GPM (6.65 L/min) max.			
		UTS232102EP	879.65	Chrome	3
		UTS232102EPBN	1232.15	Brushed Nickel	3
		UTS232102EPNL	1232.15	Polished Nickel	3
		UTS232102EPBG	1232.15	Brushed Gold	3
		UTS232102EPBL	1320.20	Matte Black	3
UTS232102EPORB	1320.20	Oil Rubbed Bronze	3		
M-CORE® 2-SERIES VALVE ONLY TRIM - PREMIUM					
 <ul style="list-style-type: none"> • includes: pressure balanced cartridge with temperature control • valve: sold separately 	<ul style="list-style-type: none"> • includes: pressure balanced cartridge with temperature control • valve: sold separately 	UTS23210	514.80	Chrome	3
		UTS23210BN	681.50	Brushed Nickel	3
		UTS23210NL	681.50	Polished Nickel	3
		UTS23210BG	681.50	Brushed Gold	3
		UTS23210BL	726.50	Matte Black	3
		UTS23210ORB	726.50	Oil Rubbed Bronze	3
M-CORE® MIXING SHOWER VALVE					
 <ul style="list-style-type: none"> • tub/shower or shower only application • ports: four with adj. temp. limit stops • included: test plug and cross flow plug 	<ul style="list-style-type: none"> • tub/shower or shower only application • ports: four with adj. temp. limit stops • quarter turn stops: included 	U140CI	71.20	1/2" CC/IPS	6
		U140X	71.20	1/2" Crimp Ring PEX + CC/IPS Tub	6
		U140CX	71.20	1/2" Cold Exp. PEX + CC/IPS Tub	6
		U140V	87.20	1/2" CPVC + CC/IPS Tub	6
 <ul style="list-style-type: none"> • tub/shower or shower only application • ports: four with adj. temp. limit stops • quarter turn stops: included 	<ul style="list-style-type: none"> • tub/shower only application • ports: four with adj. temp. limit stops • tub outlet: pre-fabricated 1/2" copper tube • included: quarter turn stops and plugs 	U140CIS	102.45	1/2" CC/IPS	6
		U140XS	102.45	1/2" Crimp Ring PEX + CC/IPS Tub	6
		U140CXS	102.45	1/2" Cold Exp. PEX + CC/IPS Tub	6
		U140VS	118.50	1/2" CPVC + CC/IPS Tub	6
 <ul style="list-style-type: none"> • tub/shower only application • ports: four with adj. temp. limit stops • tub outlet: pre-fabricated 1/2" copper tube • included: quarter turn stops and plugs 	<ul style="list-style-type: none"> • tub/shower only application • ports: four with adj. temp. limit stops • tub outlet: pre-fabricated 1/2" copper tube • included: quarter turn stops and plugs 	U140X-PF	80.40	1/2" Crimp Ring PEX	6
		U140CX-PF	80.40	1/2" Cold Exp. PEX	6
 <ul style="list-style-type: none"> • shower only application • ports: three 	<ul style="list-style-type: none"> • shower only application • ports: three • quarter turn stops: included 	U130CI	71.20	1/2" CC/IPS	6
		U130X	71.20	1/2" Crimp Ring PEX	6
		U130CX	71.20	1/2" Cold Exp. PEX	6
 <ul style="list-style-type: none"> • shower only application • ports: three • quarter turn stops: included 	<ul style="list-style-type: none"> • shower only application • ports: three • quarter turn stops: included 	U130CIS	102.45	1/2" CC/IPS	6
		U130XS	102.45	1/2" Crimp Ring PEX	6
		U130CXS	102.45	1/2" Cold Exp. PEX	6
Four port valves can be used with either Tub/Shower or Shower Only applications. Three port valves can ONLY be used with Shower Only applications. For more product details, reference pages 465-466 in valve section.					
HOW TO ORDER VALVES: PAGES 465-466		 TRIM PART #   VALVE PART #   COMPLETE FAUCET			



















WEYMOUTH®















MODEL LIST FINISH/CONNECT CASE QTY

POSI-TEMP® TUB/SHOWER TRIM - PREMIUM					
 <ul style="list-style-type: none"> • showerhead: two-function rainshower • showerhead size: 9" diameter • tub spout length: 6 3/4" • tub spout connection type: slip fit • tub spout type: diverter • valve: sold separately 	2.5 GPM (9.5 L/min) max.				
	TS32104	935.10	Chrome	3	
	TS32104BN	1311.90	Brushed Nickel	3	
	TS32104NL	1311.90	Polished Nickel	3	
	TS32104BG	1311.90	Brushed Gold	3	
	TS32104BL	1415.45	Matte Black	3	
	TS32104ORB	1415.45	Oil Rubbed Bronze	3	
	1.75 GPM (6.65 L/min) max.				
	TS32104EP	935.10	Chrome	3	
	TS32104EPBN	1311.90	Brushed Nickel	3	
TS32104EPNL	1311.90	Polished Nickel	3		
TS32104EPBG	1311.90	Brushed Gold	3		
TS32104EPBL	1415.45	Matte Black	3		
TS32104EPORB	1415.45	Oil Rubbed Bronze	3		
POSI-TEMP® SHOWER ONLY TRIM - PREMIUM					
 <ul style="list-style-type: none"> • showerhead: two-function rainshower • showerhead size: 9" diameter • valve: sold separately 	2.5 GPM (9.5 L/min) max.				
	TS32102	766.85	Chrome	3	
	TS32102BN	1119.30	Brushed Nickel	3	
	TS32102NL	1119.30	Polished Nickel	3	
	TS32102BG	1119.30	Brushed Gold	3	
	TS32102BL	1207.45	Matte Black	3	
	TS32102ORB	1207.45	Oil Rubbed Bronze	3	
	1.75 GPM (6.65 L/min) max.				
	TS32102EP	766.85	Chrome	3	
	TS32102EPBN	1119.30	Brushed Nickel	3	
TS32102EPNL	1119.30	Polished Nickel	3		
TS32102EPBG	1119.30	Brushed Gold	3		
TS32102EPBL	1207.45	Matte Black	3		
TS32102EPORB	1207.45	Oil Rubbed Bronze	3		
POSI-TEMP® SHOWER MIXING VALVES					
 <ul style="list-style-type: none"> • tub/shower or shower only application • ports: four with adjustable temp. limit stops • test plug: included 	2520 ◆	156.10	1/2" CC	6	
	2510 ◆	156.10	1/2" IPS	6	
 <ul style="list-style-type: none"> • tub/shower or shower only application • ports: four with adjustable temp. limit stops • quarter turn stops: included • test plug: included 	2570 ◆	189.55	1/2" CC	6	
	2590 ◆	189.55	1/2" IPS	6	
	2580 ◆	156.10	1/2" Crimp ring PEX	6	
 <ul style="list-style-type: none"> • tub/shower only application • ports: four with adjustable temp. limit stops • quarter turn stops: included • test plug: included 	2360PF	208.45	1/2" Crimp Ring PEX	3	
	2385PF	208.45	1/2" Cold Exp. PEX	3	
 <ul style="list-style-type: none"> • shower only application • ports: three with adjustable temp. limit stops • quarter turn stops: included • test plug: included 	2326PF	201.20	1/2" Crimp Ring PEX	6	
	2328PF	201.20	1/2" Cold Exp. PEX	6	
<p>Four port valves can be used with either Tub/Shower or Shower Only applications. Three port valves can ONLY be used with Shower Only applications. For more product details, reference page 467-468 in valve section.</p>					
<p>HOW TO ORDER VALVES: PAGES 467-470</p>	 <p>TRIM PART #</p>	+	 <p>VALVE PART #</p>	=	 <p>COMPLETE FAUCET</p>
OPTION: HANDLE CAP KIT					
 <ul style="list-style-type: none"> • description: finished handle cap kit • language: english version only 	221672	26.95	Chrome	12	
	221672BN	35.80	Brushed Nickel	12	
	221672NL	35.80	Polished Nickel	12	
	221672BG	35.80	Brushed Gold	12	
	221672BL	39.60	Matte Black	12	
	221672ORB	39.60	Oil Rubbed Bronze	12	



WEYMOUTH® Collection

		MODEL	LIST	FINISH/CONNECT	CASE QTY	
POSI-TEMP® VALVE ONLY TRIM - PREMIUM						
 <ul style="list-style-type: none"> • valve: sold separately 	 	TS3210	402.10	Chrome	3	
		TS3210BN	568.75	Brushed Nickel	3	
		TS3210NL	568.75	Polished Nickel	3	
		TS3210BG	568.75	Brushed Gold	3	
		TS3210BL	613.80	Matte Black	3	
		TS3210ORB	613.80	Oil Rubbed Bronze	3	
POSI-TEMP® SHOWER MIXING VALVES						
 <ul style="list-style-type: none"> • tub/shower or shower only application • ports: four with adjustable temp. limit stops • test plug: included 		2520 ◆	156.10	1/2" CC	6	
		2510 ◆	156.10	1/2" IPS	6	
 <ul style="list-style-type: none"> • tub/shower or shower only application • ports: four with adjustable temp. limit stops • quarter turn stops: included • test plug: included 		2570 ◆	189.55	1/2" CC	6	
		2590 ◆	189.55	1/2" IPS	6	
		2580 ◆	156.10	1/2" Crimp ring PEX	6	
 <ul style="list-style-type: none"> • tub/shower only application • ports: four with adjustable temp. limit stops • quarter turn stops: included • test plug: included 		2360PF	208.45	1/2" Crimp Ring PEX	3	
		2385PF	208.45	1/2" Cold Exp. PEX	3	
 <ul style="list-style-type: none"> • shower only application • ports: three with adjustable temp. limit stops • quarter turn stops: included • test plug: included 		2326PF	201.20	1/2" Crimp Ring PEX	6	
		2328PF	201.20	1/2" Cold Exp. PEX	6	
<p>Four port valves can be used with either Tub/Shower or Shower Only applications. Three port valves can ONLY be used with Shower Only applications. For more product details, reference page 467-468 in valve section.</p>						
<p>HOW TO ORDER VALVES: PAGES 467-470</p>		 <p>TRIM PART #</p>	+	 <p>VALVE PART #</p>	=	 <p>COMPLETE FAUCET</p>
OPTION: HANDLE CAP KIT						
 <ul style="list-style-type: none"> • description: finished handle cap kit • language: english version only 		221672	26.95	Chrome	12	
		221672BN	35.80	Brushed Nickel	12	
		221672NL	35.80	Polished Nickel	12	
		221672BG	35.80	Brushed Gold	12	
		221672BL	39.60	Matte Black	12	
		221672ORB	39.60	Oil Rubbed Bronze	12	
OPTION: ARROW CAP KIT						
 <ul style="list-style-type: none"> • description: finished arrow cap kit 		221673	18.25	Chrome	12	
		221673BN	24.35	Brushed Nickel	12	
		221673NL	24.35	Polished Nickel	12	
		221673BG	24.35	Brushed Gold	12	
		221673BL	26.85	Matte Black	12	
		221673ORB	26.85	Oil Rubbed Bronze	12	

		MODEL	LIST	FINISH/CONNECT	CASE QTY				
POSI-TEMP® WITH INTEGRATED TRANSFER VALVE TRIM - PREMIUM									
 <ul style="list-style-type: none"> valve: sold separately 		TS32100	862.15	Chrome	4				
		TS32100BN	1219.15	Brushed Nickel	4				
		TS32100NL	1219.15	Polished Nickel	4				
		TS32100BG	1219.15	Brushed Gold	4				
		TS32100BL	1315.70	Matte Black	4				
		TS32100ORB	1315.70	Oil Rubbed Bronze	4				
POSI-TEMP® WITH INTEGRATED TRANSFER VALVE									
 <ul style="list-style-type: none"> functions: three (two independent and one shared) ports: four with adjustable temp. limit stops test plug: included 		2551	281.85	1/2" IPS	6				
		 <ul style="list-style-type: none"> functions: three (two independent and one shared) ports: four with adjustable temp. limit stops stops: included test plug: included 		2581	317.40	1/2" IPS	6		
				 <ul style="list-style-type: none"> functions: two independent ports: four with adjustable temp. limit stops test plug: included 		2521	281.85	1/2" IPS	6
						 <ul style="list-style-type: none"> functions: two independent ports: four with adjustable temp. limit stops stops: included test plug: included 		2571	317.40
For more product details, reference page 471 in valve section.									
HOW TO ORDER VALVES: PAGE 471		 TRIM PART #	+	 VALVE PART #	=	 COMPLETE FAUCET			
OPTION: HANDLE CAP KIT									
 <ul style="list-style-type: none"> description: finished handle cap kit language: english version only 	221672	26.95	Chrome	12					
	221672BN	35.80	Brushed Nickel	12					
	221672NL	35.80	Polished Nickel	12					
	221672BG	35.80	Brushed Gold	12					
	221672BL	39.60	Matte Black	12					
	221672ORB	39.60	Oil Rubbed Bronze	12					
OPTION: ARROW CAP KIT									
 <ul style="list-style-type: none"> description: finished arrow cap kit 	221673	18.25	Chrome	12					
	221673BN	24.35	Brushed Nickel	12					
	221673NL	24.35	Polished Nickel	12					
	221673BG	24.35	Brushed Gold	12					
	221673BL	26.85	Matte Black	12					
	221673ORB	26.85	Oil Rubbed Bronze	12					

WEYMOUTH® Perfectly Matched Bath Accessories**Moen® bath accessories CANNOT be combined with Moen faucet parts on a Purchase Order.****A PERFECT MATCH**

A line of perfectly matching accessories - including tank levers and towel bars - allow for a completely cohesive look in the bath.

MODEL NUMBER	LIST EACH	DESCRIPTION	QTY
PREMIUM			
Chrome (CH)			
YB8401CH	133.00	Tank Lever	24
YB8403CH	120.80	Double Robe Hook	24
YB8405CH	22.35	Drawer Knob	48
YB8407CH	41.75	Drawer Pull	48
Ⓟ YB8408CH	174.40	Pivoting Paper Holder	6
YB8418CH	196.85	18" Towel Bar	6
YB8424CH	212.40	24" Towel Bar	6
YB8486CH	137.25	Towel Ring	6
Brushed Nickel (BN)			
YB8401BN	151.45	Tank Lever	24
YB8403BN	138.25	Double Robe Hook	24
YB8405BN	25.25	Drawer Knob	48
YB8407BN	44.60	Drawer Pull	48
Ⓟ YB8408BN	191.10	Pivoting Paper Holder	6
YB8418BN	223.60	18" Towel Bar	6
YB8424BN	241.20	24" Towel Bar	6
YB8486BN	156.65	Towel Ring	6
Matte Black (BL)			
YB8401BL	166.35	Tank Lever	24
YB8403BL	151.95	Double Robe Hook	24
YB8405BL	27.75	Drawer Knob	48
YB8407BL	48.85	Drawer Pull	48
Ⓟ YB8408BL	209.90	Pivoting Paper Holder	6
YB8418BL	245.75	18" Towel Bar	6
YB8424BL	264.75	24" Towel Bar	6
YB8486BL	172.15	Towel Ring	6
Polished Nickel (NL)			
YB8401NL	166.60	Tank Lever	24
YB8403NL	152.15	Double Robe Hook	24
YB8405NL	27.75	Drawer Knob	48
YB8407NL	49.05	Drawer Pull	48
Ⓟ YB8408NL	210.30	Pivoting Paper Holder	6
YB8418NL	246.15	18" Towel Bar	6
YB8424NL	265.15	24" Towel Bar	6
YB8486NL	172.35	Towel Ring	6
Brushed Gold (BG)			
YB8401BG	181.80	Tank Lever	24
YB8403BG	165.85	Double Robe Hook	24
YB8405BG	30.30	Drawer Knob	48
YB8407BG	53.55	Drawer Pull	48
Ⓟ YB8408BG	229.40	Pivoting Paper Holder	6
YB8418BG	268.25	18" Towel Bar	6
YB8424BG	289.20	24" Towel Bar	6
YB8486BG	188.05	Towel Ring	6
Oil Rubbed Bronze (ORB)			
YB8401ORB	166.60	Tank Lever	24
YB8403ORB	152.15	Double Robe Hook	24
YB8405ORB	27.75	Drawer Knob	48
YB8407ORB	49.05	Drawer Pull	48
Ⓟ YB8408ORB	210.30	Pivoting Paper Holder	6
YB8418ORB	246.15	18" Towel Bar	6
YB8424ORB	265.15	24" Towel Bar	6
YB8486ORB	172.35	Towel Ring	6

Ⓟ Denotes pivoting paper holder



Tank Lever
YB8401



Double Robe Hook
YB8403



Towel Ring
YB8486



Pivoting Paper Holder
YB8408 | Ⓟ



Drawer Knob
YB8405

























18" Towel Bar
YB8418













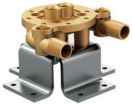





Drawer Pull
YB8407









24" Towel Bar
YB8424









List price is per each (unless otherwise noted).
Product can be ordered by case quantity or individually.
For more information on ordering bath accessories, contact Moen Bath Accessory
Customer Service at **800-882-0116**, contact your local Moen sales representative,
or visit us at www.moen.com.























	MODEL	LIST	FINISH/CONNECT	CASE QTY
ONE-HANDLE BATHROOM FAUCET - PREMIUM				
 <ul style="list-style-type: none"> • application: one hole • supply lines: flexible • connection: 3/8" compression • drain assembly: metal • drain assembly type: spring loaded pop-up <p> DURALAST®</p>	<p> 1.2 GPM (4.5L/min) max.</p>			
	S43001	712.15	Chrome	3
	S43001BL	1032.60	Matte Black	3
TWO-HANDLE WIDESPREAD BATHROOM FAUCET TRIM - PREMIUM				
 <ul style="list-style-type: none"> • application: three hole • center dimensions: 8" - 16" center • drain assembly: metal with lift rod • valve: sold separately <p> </p>	<p> 1.2 GPM (4.5L/min) max.</p>			
	TS43002	771.00	Chrome	3
	TS43002BL	1156.50	Matte Black	3
WIDESPREAD FAUCET VALVE				
 <ul style="list-style-type: none"> • application: three hole • center dimensions: 8" - 16" center • drain assembly: metal with lift rod <p> DURALOCK® DURALAST®</p>	9000◆	162.15	1/2" IPS	6
<p>HOW TO ORDER VALVES: PAGE 463</p> <p>  TRIM PART # +  VALVE PART # =  COMPLETE FAUCET </p>				
TWO-HANDLE WALLMOUNT BATHROOM FAUCET TRIM - PREMIUM				
 <ul style="list-style-type: none"> • application: three hole • center dimensions: 8" center • drain assembly: 140780 sold separately • valve: sold separately <p> </p>	<p> 1.2 GPM (4.5L/min) max.</p>			
	TS43003	789.10	Chrome	3
	TS43003BL	1183.65	Matte Black	3
TWO-HANDLE WALLMOUNT FAUCET VALVE				
 <ul style="list-style-type: none"> • application: three hole • center dimensions: 8" center • drain assembly: 140780 sold separately • includes: mounting brackets <p> DURALAST®</p>	9700	229.35	1/2" CC	3
<p>HOW TO ORDER VALVES: PAGE 463</p> <p>  TRIM PART # +  VALVE PART # =  COMPLETE FAUCET </p>				
OPTION: DRAIN ASSEMBLY				
 <ul style="list-style-type: none"> • drain assembly: metal • drain assembly type: spring loaded pop-up • drain assembly size: 1-1/4" • drain assembly: 1-1/4" non-overflow 	140780	76.80	Chrome	12
	140780BL	120.90	Matte Black	12

		MODEL	LIST	FINISH/CONNECT	CASE QTY			
FREESTANDING TUB FILLER TRIM - PREMIUM								
	<ul style="list-style-type: none"> • application: one hole • showerhead type: handshower • handshower functions: one-function • handshower flow rate: 1.75 gpm (6.65 L/min) max. • spout reach: 11.00" • mounting kit: sold separately 	S93005	2246.60	Chrome	1			
		Q3 NEW! S93005BL	3032.90	Matte Black	1			
FREESTANDING TUB FILLER VALVE AND MOUNTING KIT - PREMIUM								
	<ul style="list-style-type: none"> • description: single riser floor joist mounting kit • application: one hole • quarter turn stops: included 	TS50100	400.90	1/2" CC, NPT	2			
	<ul style="list-style-type: none"> • description: single riser concrete mounting kit • application: one hole • connection size: 1/2" 	TS50110	325.95	1/2" CC, NPT	2			
HOW TO ORDER VALVES: PAGE 463		TRIM PART #	+		VALVE PART #	=		COMPLETE FAUCET















TWO-HANDLE ROMAN TUB TRIM - PREMIUM								
	<ul style="list-style-type: none"> • application: three hole • spout reach: 8.08" • valve: sold separately 	TS93003	1004.20	Chrome	3			
		TS93003BL	1597.55	Matte Black	3			
TWO-HANDLE ROMAN TUB TRIM WITH HANDSHOWER - PREMIUM								
	<ul style="list-style-type: none"> • application: four hole • showerhead type: handshower • handshower flow rate: 1.75 gpm (6.65 L/min) max. • spray functions: one-function • spout reach: 8.08" • valve: sold separately 	TS93004	1533.35	Chrome	3			
		TS93004BL	3008.05	Matte Black	3			
TWO-HANDLE ROMAN TUB VALVE								
	<ul style="list-style-type: none"> • deck thickness: 1/8" to 3-3/8" rough-in deck • adjustable spout shank: adjustable center dimensions 	4792	188.55	1/2" CC	6			
	<ul style="list-style-type: none"> • deck thickness: 1/8" to 2-3/4" rough-in deck • adjustable spout shank: 10" - 24" center dimensions 	DURALOCK® DURALAST®						
		4793	213.55	1/2" CPVC, Crimp Ring PEX	6			
	<ul style="list-style-type: none"> • deck thickness: 1/8" to 3-3/16" rough-in deck • Non-adjustable spout shank: 10" center dimensions 	DURALOCK® DURALAST®						
		4796	177.65	1/2" CC	6			
		4797	181.10	1/2" CPVC, Crimp Ring PEX	6			
		4798	181.10	1/2" Crimp Ring PEX, Cold Exp. PEX	6			
TWO-HANDLE ROMAN TUB VALVE WITH HANDSHOWER								
	<ul style="list-style-type: none"> • deck thickness: 1/8" to 2-5/8" rough-in deck • non-adj spout shank: adjustable center dim's 	9792	424.85	1/2" CC	6			
	<ul style="list-style-type: none"> • deck thickness: 1/8" to 2-5/8" rough-in deck • adj spout shank: 10" - 24" center dimensions 	DURALOCK® DURALAST®						
		9793	434.80	1/2" CPVC, Crimp Ring PEX	6			
For more product details, reference page 464 in valve section.								
HOW TO ORDER VALVES: PAGE 464		TRIM PART #	+		VALVE PART #	=		COMPLETE FAUCET

		MODEL	LIST	FINISH/CONNECT	CASE QTY	
EXACTTEMP® VALVE ONLY TRIM - PREMIUM						
 <ul style="list-style-type: none"> • description: temperature control valve trim • requires: separate volume control valve • valve: sold separately  		TS33002	399.80	Chrome	3	
		TS33002BL	659.80	Matte Black	3	
EXACTTEMP® THERMOSTATIC MIXING SHOWER VALVE - PREMIUM						
 <ul style="list-style-type: none"> • description: thermostatic rough-in valve • ports: four with adjustable temp. limit stops • check stops: included 		S3371	714.65	¾" IPS	6	
HOW TO ORDER VALVES: PAGE 465		 TRIM PART #	+	 VALVE PART #	=	 COMPLETE FAUCET









EXACTTEMP® VOLUME CONTROL VALVE TRIM - PREMIUM						
 <ul style="list-style-type: none"> • valve: sold separately  		TS33003	228.40	Chrome	6	
		TS33003BL	366.60	Matte Black	6	
EXACTTEMP® VOLUME CONTROL SHOWER VALVE - PREMIUM						
 <ul style="list-style-type: none"> • includes: volume control 		S3600	181.70	¾" IPS	12	
HOW TO ORDER VALVES: PAGE 465		 TRIM PART #	+	 VALVE PART #	=	 COMPLETE FAUCET









		MODEL	LIST	FINISH/CONNECT	CASE QTY	
M-CORE® 4-SERIES TUB/SHOWER TRIM - PREMIUM						
	<ul style="list-style-type: none"> • showerhead type: eco-performance rainshower • showerhead size: 10" diameter • tub spout length: 6 3/4" • tub spout connection type: slip fit • tub spout type: diverter • includes: thermostatic cartridge with volume and temperature control • valve: sold separately 	 1.75 GPM (6.65 L/min) max.				
		UTS42003EP	1141.30	Chrome	3	
		UTS42003EPBL	1712.45	Matte Black	3	
M-CORE® 4-SERIES SHOWER ONLY TRIM - PREMIUM						
	<ul style="list-style-type: none"> • showerhead type: eco-performance rainshower • showerhead size: 10" diameter • includes: thermostatic cartridge with volume and temperature control • valve: sold separately 	 1.75 GPM (6.65 L/min) max.				
		UTS42002EP	1023.70	Chrome	3	
		UTS42002EPBL	1511.05	Matte Black	3	
M-CORE® 4-SERIES VALVE ONLY TRIM - PREMIUM						
	<ul style="list-style-type: none"> • includes: thermostatic cartridge with volume and temperature control • valve: sold separately 	UTS42001	702.60	Chrome	3	
		UTS42001BL	944.15	Matte Black	3	
M-CORE® MIXING SHOWER VALVE						
	<ul style="list-style-type: none"> • tub/shower or shower only application • ports: four with adj. temp. limit stops • included: test plug and cross flow plug 	U140CI	71.20	1/2" CC/IPS	6	
		U140X	71.20	1/2" Crimp Ring PEX + CC/IPS Tub	6	
		U140CX	71.20	1/2" Cold Exp. PEX + CC/IPS Tub	6	
		U140V	87.20	1/2" CPVC + CC/IPS Tub	6	
	<ul style="list-style-type: none"> • tub/shower or shower only application • ports: four with adj. temp. limit stops • quarter turn stops: included 	U140CIS	102.45	1/2" CC/IPS	6	
		U140XS	102.45	1/2" Crimp Ring PEX + CC/IPS Tub	6	
		U140CXS	102.45	1/2" Cold Exp. PEX + CC/IPS Tub	6	
		U140VS	118.50	1/2" CPVC + CC/IPS Tub	6	
	<ul style="list-style-type: none"> • tub/shower only application • ports: four with adj. temp. limit stops • tub outlet: pre-fabricated 1/2" copper tube • included: quarter turn stops and plugs 	U140X-PF	80.40	1/2" Crimp Ring PEX	6	
		U140CX-PF	80.40	1/2" Cold Exp. PEX	6	
	<ul style="list-style-type: none"> • tub/shower only application • ports: four with adj. temp. limit stops • tub outlet: pre-fabricated 1/2" copper tube • included: quarter turn stops and plugs 	U140XS-PF	111.70	1/2" Crimp Ring PEX	6	
		U140CXS-PF	111.70	1/2" Cold Exp. PEX	6	
	<ul style="list-style-type: none"> • shower only application • ports: three 	U130CI	71.20	1/2" CC/IPS	6	
		U130X	71.20	1/2" Crimp Ring PEX	6	
		U130CX	71.20	1/2" Cold Exp. PEX	6	
	<ul style="list-style-type: none"> • shower only application • ports: three • quarter turn stops: included 	U130CIS	102.45	1/2" CC/IPS	6	
		U130XS	102.45	1/2" Crimp Ring PEX	6	
		U130CXS	102.45	1/2" Cold Exp. PEX	6	
<p>Four port valves can be used with either Tub/Shower or Shower Only applications. Three port valves can ONLY be used with Shower Only applications. For more product details, reference pages 465-466 in valve section.</p>						
HOW TO ORDER VALVES: PAGES 465-466		 TRIM PART #	+	 VALVE PART #	=	 COMPLETE FAUCET



















ARRIS®

		MODEL	LIST	FINISH/CONNECT	CASE QTY	
M-CORE® 3-SERIES TUB/SHOWER TRIM - PREMIUM						
 <ul style="list-style-type: none"> • showerhead: single-function rainshower • showerhead size: 10" diameter • tub spout length: 6 3/4" • tub spout connection type: slip fit • tub spout type: diverter • includes: pressure balanced cartridge with volume and temperature control • valve: sold separately 			2.5 GPM (9.5 L/min) max.			
		UTS32003	1006.30	Chrome	3	
		UTS32003BL	1577.45	Matte Black	4	
				1.75 GPM (6.65 L/min) max.		
		UTS32003EP	1006.30	Chrome	3	
		UTS32003EPBL	1577.45	Matte Black	3	
						
M-CORE® 3-SERIES SHOWER ONLY TRIM - PREMIUM						
 <ul style="list-style-type: none"> • showerhead: single-function rainshower • showerhead size: 10" diameter • includes: pressure balanced cartridge with volume and temperature control • valve: sold separately 			2.5 GPM (9.5 L/min) max.			
		UTS32002	888.70	Chrome	3	
		UTS32002BL	1376.05	Matte Black	3	
				1.75 GPM (6.65 L/min) max.		
		UTS32002EP	888.70	Chrome	3	
		UTS32002EPBL	1376.05	Matte Black	3	
						
M-CORE® 3-SERIES VALVE ONLY TRIM - PREMIUM						
 <ul style="list-style-type: none"> • includes: pressure balanced cartridge with volume and temperature control • valve: sold separately 		UTS32001	567.60	Chrome	3	
			UTS32001BL	809.15	Matte Black	3
						
M-CORE® MIXING SHOWER VALVE						
 <ul style="list-style-type: none"> • tub/shower or shower only application • ports: four with adj. temp. limit stops • included: test plug and cross flow plug 		U140CI	71.20	1/2" CC/IPS	6	
		U140X	71.20	1/2" Crimp Ring PEX + CC/IPS Tub	6	
		U140CX	71.20	1/2" Cold Exp. PEX + CC/IPS Tub	6	
		U140V	87.20	1/2" CPVC + CC/IPS Tub	6	
 <ul style="list-style-type: none"> • tub/shower or shower only application • ports: four with adj. temp. limit stops • quarter turn stops: included 		U140CIS	102.45	1/2" CC/IPS	6	
		U140XS	102.45	1/2" Crimp Ring PEX + CC/IPS Tub	6	
		U140CXS	102.45	1/2" Cold Exp. PEX + CC/IPS Tub	6	
		U140VS	118.50	1/2" CPVC + CC/IPS Tub	6	
 <ul style="list-style-type: none"> • tub/shower only application • ports: four with adj. temp. limit stops • tub outlet: pre-fabricated 1/2" copper tube • included: quarter turn stops and plugs 		U140X-PF	80.40	1/2" Crimp Ring PEX	6	
		U140CX-PF	80.40	1/2" Cold Exp. PEX	6	
 <ul style="list-style-type: none"> • tub/shower only application • ports: four with adj. temp. limit stops • tub outlet: pre-fabricated 1/2" copper tube • included: quarter turn stops and plugs 		U140XS-PF	111.70	1/2" Crimp Ring PEX	6	
		U140CXS-PF	111.70	1/2" Cold Exp. PEX	6	
 <ul style="list-style-type: none"> • shower only application • ports: three 		U130CI	71.20	1/2" CC/IPS	6	
		U130X	71.20	1/2" Crimp Ring PEX	6	
		U130CX	71.20	1/2" Cold Exp. PEX	6	
 <ul style="list-style-type: none"> • shower only application • ports: three • quarter turn stops: included 		U130CIS	102.45	1/2" CC/IPS	6	
		U130XS	102.45	1/2" Crimp Ring PEX	6	
		U130CXS	102.45	1/2" Cold Exp. PEX	6	
<p>Four port valves can be used with either Tub/Shower or Shower Only applications. Three port valves can ONLY be used with Shower Only applications. For more product details, reference pages 465-466 in valve section.</p>						
HOW TO ORDER VALVES: PAGES 465-466		 TRIM PART #	+	 VALVE PART #	=	 COMPLETE FAUCET

























		MODEL	LIST	FINISH/CONNECT	CASE QTY			
M-CORE® 3-SERIES WITH INTEGRATED TRANSFER VALVE TRIM - PREMIUM								
 <ul style="list-style-type: none"> • includes: pressure balanced cartridge with volume and temperature control • valve: sold separately 		UTS3311	503.10	Chrome	4			
		UTS3311BL	1094.95	Matte Black	4			
M-CORE® WITH INTEGRATED TRANSFER VALVE								
Three Function (2 independent/1 shared) OR Six Function (3 independent/3 shared) - plumbing configuration page 472								
 <ul style="list-style-type: none"> • ports: four with adj. temp. limit stops • check stops: included 		U362CIS	265.40	1/2" CC/IPS	6			
		U362CXS	265.40	1/2" Cold Exp. PEX	6			
		U362XS	265.40	1/2" Crimp Ring PEX	6			
Two Independent Functions OR Three Independent Functions - plumbing configurations page 472								
 <ul style="list-style-type: none"> • ports: four with adj. temp. limit stops • check stops: included 		U232CIS	265.40	1/2" CC/IPS	6			
		U232CXS	265.40	1/2" Cold Exp. PEX	6			
		U232XS	265.40	1/2" Crimp Ring PEX	6			
For more product details, reference page 466 in valve section. See page 472 for plumbing configurations.								
HOW TO ORDER VALVES: PAGE 466		TRIM PART #	+		VALVE PART #	=		COMPLETE FAUCET

M-CORE® TRANSFER VALVE TRIM - PREMIUM								
 <ul style="list-style-type: none"> • use with the M-CORE® transfer valve • valve: sold separately 		UTS23005	434.20	Chrome	12			
		UTS23005BL	557.70	Matte Black	12			
M-CORE® TRANSFER VALVE								
Three Function (2 independent/1 shared) OR Six Function (3 independent/3 shared) - plumbing configuration page 472								
 <ul style="list-style-type: none"> • number of functions: three or six • ports: four 		U361CI	149.70	1/2" CC/IPS	6			
		U361CX	149.70	1/2" Cold Exp. PEX	6			
		U361X	149.70	1/2" Crimp Ring PEX	6			
Two Independent Functions OR Three Independent Functions - plumbing configurations page 472								
 <ul style="list-style-type: none"> • number of functions: two or three • ports: four 		U231CI	149.70	1/2" CC/IPS	6			
		U231CX	149.70	1/2" Cold Exp. PEX	6			
		U231X	149.70	1/2" Crimp Ring PEX	6			
For more product details, reference page 466 in valve section. See page 472 for plumbing configurations.								
HOW TO ORDER VALVES: PAGE 466		TRIM PART #	+		VALVE PART #	=		COMPLETE FAUCET

		MODEL	LIST	FINISH/CONNECT	CASE QTY
M-CORE® 2-SERIES TUB/SHOWER TRIM - PREMIUM					
 <ul style="list-style-type: none"> showerhead: single-function eco-performance rainshower showerhead size: 10" diameter tub spout length: 6 3/4" tub spout connection type: slip fit tub spout type: diverter includes: pressure balanced cartridge with temperature control valve: sold separately 			1.75 GPM (6.65 L/min) max.		
		UTS22003EP	984.65	Chrome	3
		UTS22003EPBL	1504.05	Matte Black	3
					
M-CORE® 2-SERIES SHOWER ONLY TRIM - PREMIUM					
 <ul style="list-style-type: none"> showerhead: single-function eco-performance rainshower showerhead size: 10" diameter includes: pressure balanced cartridge with temperature control valve: sold separately 			1.75 GPM (6.65 L/min) max.		
		UTS22002EP	841.05	Chrome	3
		UTS22002EPBL	1282.75	Matte Black	3
					
M-CORE® 2-SERIES VALVE ONLY TRIM - PREMIUM					
 <ul style="list-style-type: none"> includes: pressure balanced cartridge with temperature control valve: sold separately 		UTS22001	486.45	Chrome	3
		UTS22001BL	724.05	Matte Black	3
					
M-CORE® MIXING SHOWER VALVE					
 <ul style="list-style-type: none"> tub/shower or shower only application ports: four with adj. temp. limit stops included: test plug and cross flow plug 		U140CI	71.20	1/2" CC/IPS	6
		U140X	71.20	1/2" Crimp Ring PEX + CC/IPS Tub	6
		U140CX	71.20	1/2" Cold Exp. PEX + CC/IPS Tub	6
		U140V	87.20	1/2" CPVC + CC/IPS Tub	6
					
 <ul style="list-style-type: none"> tub/shower or shower only application ports: four with adj. temp. limit stops quarter turn stops: included 		U140CIS	102.45	1/2" CC/IPS	6
		U140XS	102.45	1/2" Crimp Ring PEX + CC/IPS Tub	6
		U140CXS	102.45	1/2" Cold Exp. PEX + CC/IPS Tub	6
		U140VS	118.50	1/2" CPVC + CC/IPS Tub	6
					
 <ul style="list-style-type: none"> tub/shower only application ports: four with adj. temp. limit stops tub outlet: pre-fabricated 1/2" copper tube included: quarter turn stops and plugs 		U140X-PF	80.40	1/2" Crimp Ring PEX	6
		U140CX-PF	80.40	1/2" Cold Exp. PEX	6
					
 <ul style="list-style-type: none"> tub/shower only application ports: four with adj. temp. limit stops tub outlet: pre-fabricated 1/2" copper tube included: quarter turn stops and plugs 		U140XS-PF	111.70	1/2" Crimp Ring PEX	6
		U140CXS-PF	111.70	1/2" Cold Exp. PEX	6
					
 <ul style="list-style-type: none"> shower only application ports: three 		U130CI	71.20	1/2" CC/IPS	6
		U130X	71.20	1/2" Crimp Ring PEX	6
		U130CX	71.20	1/2" Cold Exp. PEX	6
					
 <ul style="list-style-type: none"> shower only application ports: three quarter turn stops: included 		U130CIS	102.45	1/2" CC/IPS	6
		U130XS	102.45	1/2" Crimp Ring PEX	6
		U130CXS	102.45	1/2" Cold Exp. PEX	6
					
<p>Four port valves can be used with either Tub/Shower or Shower Only applications. Three port valves can ONLY be used with Shower Only applications. For more product details, reference pages 465-466 in valve section.</p>					
<p>HOW TO ORDER VALVES: PAGES 465-466</p>					



		MODEL	LIST	FINISH/CONNECT	CASE QTY
POSI-TEMP® TUB/SHOWER TRIM - PREMIUM					
 <ul style="list-style-type: none"> • showerhead: single-function rainshower • showerhead size: 10" diameter • tub spout length: 6 3/4" • tub spout connection type: slip fit • tub spout type: diverter • valve: sold separately 		2.5 GPM (9.5 L/min) max.			
		TS22003	871.90	Chrome	3
		TS22003BL	1391.30	Matte Black	3
		1.75 GPM (6.65 L/min) max.			
		TS22003EP	871.90	Chrome	3
		TS22003EPBL	1391.30	Matte Black	3
POSI-TEMP® SHOWER ONLY TRIM - PREMIUM					
 <ul style="list-style-type: none"> • showerhead: single-function rainshower • showerhead size: 10" diameter • valve: sold separately 		2.5 GPM (9.5 L/min) max.			
		TS22002	728.30	Chrome	3
		TS22002BL	1170.00	Matte Black	3
		1.75 GPM (6.65 L/min) max.			
		TS22002EP	728.30	Chrome	3
		TS22002EPBL	1170.00	Matte Black	3
POSI-TEMP® VALVE ONLY TRIM - PREMIUM					
 <ul style="list-style-type: none"> • valve: sold separately 		TS22001	373.70	Chrome	3
		TS22001BL	611.35	Matte Black	3
POSI-TEMP® SHOWER MIXING VALVES					
 <ul style="list-style-type: none"> • tub/shower or shower only application • ports: four with adjustable temp. limit stops • test plug: included 		2520 ◆	156.10	1/2" CC	6
		2510 ◆	156.10	1/2" IPS	6
 <ul style="list-style-type: none"> • tub/shower or shower only application • ports: four with adjustable temp. limit stops • quarter turn stops: included • test plug: included 		2570 ◆	189.55	1/2" CC	6
		2590 ◆	189.55	1/2" IPS	6
		2580 ◆	156.10	1/2" Crimp ring PEX	6
 <ul style="list-style-type: none"> • tub/shower only application • ports: four with adjustable temp. limit stops • quarter turn stops: included • test plug: included 		2360PF	208.45	1/2" Crimp Ring PEX	3
		2385PF	208.45	1/2" Cold Exp. PEX	3
 <ul style="list-style-type: none"> • shower only application • ports: three with adjustable temp. limit stops • quarter turn stops: included • test plug: included 		2326PF	201.20	1/2" Crimp Ring PEX	6
		2328PF	201.20	1/2" Cold Exp. PEX	6
<p>Four port valves can be used with either Tub/Shower or Shower Only applications. Three port valves can ONLY be used with Shower Only applications. For more product details, reference page 467-468 in valve section.</p>					
HOW TO ORDER VALVES: PAGES 467-470					

		MODEL	LIST	FINISH/CONNECT	CASE QTY
POSI-TEMP® WITH INTEGRATED TRANSFER VALVE TRIM - PREMIUM					
 <ul style="list-style-type: none"> valve: sold separately 	 	TS22000	801.35	Chrome	4
		TS22000BL	1310.60	Matte Black	4
POSI-TEMP® WITH INTEGRATED TRANSFER VALVE					
 <ul style="list-style-type: none"> functions: three (two independent and one shared) ports: four with adjustable temp. limit stops test plug: included 		2551	281.85	1/2" IPS	6
 <ul style="list-style-type: none"> functions: three (two independent and one shared) ports: four with adjustable temp. limit stops stops: included test plug: included 		2581	317.40	1/2" IPS	6
 <ul style="list-style-type: none"> functions: two independent ports: four with adjustable temp. limit stops test plug: included 		2521	281.85	1/2" IPS	6
 <ul style="list-style-type: none"> functions: two independent ports: four with adjustable temp. limit stops stops: included test plug: included 		2571	317.40	1/2" IPS	6
For more product details, reference page 471 in valve section.					
HOW TO ORDER VALVES: PAGE 471	 TRIM PART #	+	 VALVE PART #	=	 COMPLETE FAUCET



Moen® bath accessories CANNOT be combined with Moen faucet parts on a Purchase Order.

A PERFECT MATCH

A line of perfectly matching accessories - including tank levers and towel bars - allow for a completely cohesive look in the bath.

MODEL NUMBER	LIST EACH	DESCRIPTION	QTY
PREMIUM			
Chrome (CH)			
YB0801CH	112.25	Tank Lever	24
YB0803CH	107.80	Double Robe Hook	24
Ⓟ YB0808CH	153.40	Pivoting Paper Holder	6
YB0818CH	177.60	18" Towel Bar	6
YB0824CH	191.65	24" Towel Bar	6
YB0886CH	124.05	Towel Ring	6
YB0892CH	309.25	5X Magnifying Mirror	3
Matte Black (BL)			
YB0801BL	135.90	Tank Lever	24
YB0803BL	130.65	Double Robe Hook	24
Ⓟ YB0808BL	185.80	Pivoting Paper Holder	6
YB0818BL	215.10	18" Towel Bar	6
YB0824BL	232.15	24" Towel Bar	6
YB0886BL	150.15	Towel Ring	6
YB0892BL	374.50	5X Magnifying Mirror	3

Ⓟ Denotes pivoting paper holder



Tank Lever
YB0801



Double Robe Hook
YB0803



Towel Ring
YB0886



Pivoting Paper Holder
YB0808 | Ⓟ



18" Towel Bar
YB0818

24" Towel Bar
YB0824



5x Magnifying Mirror
YB0892

GRAB BARS Ⓟ

MODEL NUMBER	LIST EACH	DESCRIPTION	QTY
PREMIUM			
1 1/4" • Chrome (CH)			
YG0812CH	202.20	12" Designer Grab Bar	6
YG0818CH	211.25	18" Designer Grab Bar	6
YG0824CH	220.75	24" Designer Grab Bar	6
YG0836CH	251.25	36" Designer Grab Bar	6
YG0842CH	351.65	42" Designer Grab Bar	6
1 1/4" • Matte Black (BL)			
YG0812BL	244.20	12" Designer Grab Bar	6
YG0818BL	255.20	18" Designer Grab Bar	6
YG0824BL	266.65	24" Designer Grab Bar	6
YG0836BL	303.65	36" Designer Grab Bar	6
YG0842BL	424.85	42" Designer Grab Bar	6

SECUREMOUNT

- SecureMount™ Grab Bars are manufactured with an innovative flange design that makes it easy to connect to the stud at multiple points.
- Tested to withstand 500lbs.
- To install grab bars securely without studs, use SecureMount™ Anchors. Sold separately.





18" Designer Grab Bar
YG0818







ARRIS®

Ⓟ Complies with Americans with Disabilities Act (ADA) specifications. SecureMount™ Grab Bars are tested to withstand 500 lb. pull when securely installed per instructions.









List price is per each (unless otherwise noted). Product can be ordered by case quantity or individually. For more information on ordering bath accessories, contact Moen Bath Accessory Customer Service at 800-882-0116, contact your local Moen sales representative, or visit us at www.moen.com.









FLARA™ Collection

		MODEL	LIST	FINISH/CONNECT	CASE QTY
TOUCHLESS ONE-HANDLE BATHROOM FAUCET - MOTIONSENSE WAVE™ - PREMIUM					
 <p>DECKPLATE SOLD SEPARATELY</p>	<ul style="list-style-type: none"> • application: one or three hole • supply lines: flexible • connection: 3/8" compression • deckplate: sold separately • drain assembly: metal • drain assembly type: spring loaded pop-up • DC powered: 6 AA batteries included 	<p>1.2 GPM (4.5L/min) max.</p>			
		 <p> DURALOCK® DURALAST®</p>	<p>S6981EW 1009.30 Chrome 3</p> <p>S6981EWBN 1261.60 Brushed Nickel 3</p> <p>S6981EWNL 1312.05 Polished Nickel 3</p> <p>S6981EWBG 1362.55 Brushed Gold 3</p>	<p>OPTIONAL DECKPLATE SOLD SEPARATELY</p> <p>161919 26.35 Chrome 20</p> <p>161919BN 37.35 Brushed Nickel 20</p> <p>161919NL 37.35 Polished Nickel 20</p> <p>161919BG 37.35 Brushed Gold 20</p>	
		<p>OPTIONAL AC ADAPTERS SOLD SEPARATELY</p> <p>169031 156.45 N/A or Unfinished 12</p>			

ONE-HANDLE BATHROOM FAUCET - PREMIUM					
 <p>DECKPLATE SOLD SEPARATELY</p>	<ul style="list-style-type: none"> • application: one or three hole • supply lines: flexible • connection: 3/8" compression • deckplate: sold separately • drain assembly: metal • drain assembly type: spring loaded pop-up 	<p>1.2 GPM (4.5L/min) max.</p>			
		 <p> DURALAST®</p>	<p>S6981 643.05 Chrome 3</p> <p>S6981BN 835.95 Brushed Nickel 3</p> <p>S6981NL 900.25 Polished Nickel 3</p> <p>S6981BG 932.40 Brushed Gold 3</p>	<p>OPTIONAL DECKPLATE SOLD SEPARATELY</p> <p>161919 26.35 Chrome 20</p> <p>161919BN 37.35 Brushed Nickel 20</p> <p>161919NL 37.35 Polished Nickel 20</p> <p>161919BG 37.35 Brushed Gold 20</p>	
 <p>DECKPLATE SOLD SEPARATELY</p>	<ul style="list-style-type: none"> • application: one or three hole • supply lines: flexible • connection: 3/8" compression • deckplate: sold separately • drain assembly: 140780 sold separately 	<p>1.2 GPM (4.5L/min) max.</p>			
		 <p> DURALAST®</p>	<p>S6982 771.65 Chrome 3</p> <p>S6982BN 1003.15 Brushed Nickel 3</p> <p>S6982NL 1080.35 Polished Nickel 3</p> <p>S6982BG 1118.90 Brushed Gold 3</p>	<p>OPTIONAL DECKPLATE SOLD SEPARATELY</p> <p>161919 26.35 Chrome 20</p> <p>161919BN 37.35 Brushed Nickel 20</p> <p>161919NL 37.35 Polished Nickel 20</p> <p>161919BG 37.35 Brushed Gold 20</p>	
OPTION: DRAIN ASSEMBLY					
	<ul style="list-style-type: none"> • drain assembly: metal • drain assembly type: spring loaded pop-up • drain assembly size: 1-1/4" • drain assembly: 1-1/4" non-overflow 	<p>140780 76.80 Chrome 12</p> <p>140780BN 107.05 Brushed Nickel 12</p> <p>140780NL 107.05 Polished Nickel 12</p> <p>140780BG 107.05 Brushed Gold 12</p>			









FLARA™ Collection

	MODEL	LIST	FINISH/CONNECT	CASE QTY	
TWO-HANDLE WIDESPREAD BATHROOM FAUCET TRIM - PREMIUM					
 <ul style="list-style-type: none"> • application: three hole • center dimensions: 8" - 16" center • drain assembly: metal with lift rod • valve: sold separately 	1.2 GPM (4.5L/min) max.				
	TS6984	613.65	Chrome	3	
	TS6984BN	797.75	Brushed Nickel	3	
	TS6984NL	859.15	Polished Nickel	3	
	TS6984BG	889.80	Brushed Gold	3	
 <ul style="list-style-type: none"> • application: three hole • center dimensions: 8" - 16" center • drain assembly: metal with lift rod • valve: sold separately 	1.2 GPM (4.5L/min) max.				
	TS6985	640.40	Chrome	3	
	TS6985BN	832.50	Brushed Nickel	3	
	TS6985NL	896.55	Polished Nickel	3	
	TS6985BG	928.55	Brushed Gold	3	
WIDESPREAD FAUCET VALVE					
 <ul style="list-style-type: none"> • application: three hole • center dimensions: 8" - 16" center • drain assembly: metal with lift rod  DURALOCK® DURALAST®	9000◆	162.15	1/2" IPS	6	
HOW TO ORDER VALVES: PAGE 463	 TRIM PART #	+	 VALVE PART #	=	 COMPLETE FAUCET

FREESTANDING TUB FILLER TRIM - PREMIUM					
 <ul style="list-style-type: none"> • application: one hole • showerhead type: handshower • handshower functions: one-function • handshower flow rate: 1.75 gpm (6.65 L/min) max. • spout reach: 10.71" • mounting kit: sold separately 	S931	2191.75	Chrome	1	
	S931BN	2958.80	Brushed Nickel	1	
	S931NL	2958.80	Polished Nickel	1	
	S931BG	2958.80	Brushed Gold	1	
	FREESTANDING TUB FILLER VALVE AND MOUNTING KIT - PREMIUM				
 <ul style="list-style-type: none"> • description: single riser floor joist mounting kit • application: one hole • quarter turn stops: included 	TS50100	400.90	1/2" CC, NPT	2	
	 <ul style="list-style-type: none"> • description: single riser concrete mounting kit • application: one hole • connection size: 1/2" 	TS50110	325.95	1/2" CC, NPT	2
HOW TO ORDER VALVES: PAGE 463		 TRIM PART #	+	 VALVE PART #	=













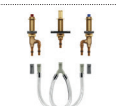

FLARA™

FLARA™ Collection

	MODEL	LIST	FINISH/CONNECT	CASE QTY
ONE-HANDLE WALLMOUNT TUB FILLER TRIM - PREMIUM				
 <ul style="list-style-type: none"> • application: two hole • connection: 1/2" slip fit • tub spout type: non diverter • spout reach: 10.00" • includes: high flow volume control cartridge • WMV130 series valve kit: sold separately 	WTS921	800.00	Chrome	3
	WTS921BN	1220.80	Brushed Nickel	3
	WTS921NL	1120.00	Polished Nickel	3
	WTS921BG	1120.00	Brushed Gold	3
ONE-HANDLE WALLMOUNT TUB FILLER VALVE KIT				
 <ul style="list-style-type: none"> • application: two hole with adj. center dimensions • ports: three • quarter turn stops: included • includes: test plug • includes: spout manifold 	WMV130CIS	151.05	1/2" CC/IPS	6
	WMV130XS	151.05	1/2" Crimp Ring PEX	6
	WMV130CXS	151.05	1/2" Cold Exp. PEX	6
<p>HOW TO ORDER VALVES: PAGE 463</p>   <p>TRIM PART #</p> <p>+</p>  <p>VALVE PART #</p> <p>=</p>   <p>COMPLETE FAUCET</p>				



















FLARA™ Collection

	MODEL	LIST	FINISH/CONNECT	CASE QTY
TWO-HANDLE ROMAN TUB TRIM - PREMIUM				
 <ul style="list-style-type: none"> • application: three hole • spout reach: 8.12" • valve: sold separately 	TS926	1035.00	Chrome	3
	TS926BN	1500.70	Brushed Nickel	3
	TS926NL	1500.70	Polished Nickel	3
	TS926BG	1500.70	Brushed Gold	3
 <ul style="list-style-type: none"> • application: three hole • spout reach: 8.12" • valve: sold separately 	TS927	1061.65	Chrome	3
	TS927BN	1527.40	Brushed Nickel	3
	TS927NL	1527.40	Polished Nickel	3
	TS927BG	1527.40	Brushed Gold	3
TWO-HANDLE ROMAN TUB TRIM WITH HANDSHOWER - PREMIUM				
 <ul style="list-style-type: none"> • application: four hole • showerhead type: handshower • handshower flow rate: 1.75 gpm (6.65 L/min) max. • spray functions: one-function • spout reach: 8.12" • valve: sold separately 	TS928	1364.85	Chrome	3
	TS928BN	1978.95	Brushed Nickel	3
	TS928NL	1978.95	Polished Nickel	3
	TS928BG	1978.95	Brushed Gold	3
 <ul style="list-style-type: none"> • application: four hole • showerhead type: handshower • handshower flow rate: 1.75 gpm (6.65 L/min) max. • spray functions: one-function • spout reach: 8.12" • valve: sold separately 	TS929	1391.45	Chrome	3
	TS929BN	2005.65	Brushed Nickel	3
	TS929NL	2005.65	Polished Nickel	3
	TS929BG	2005.65	Brushed Gold	3
TWO-HANDLE ROMAN TUB VALVE				
 <ul style="list-style-type: none"> • deck thickness: 1/8" to 3-3/8" rough-in deck • adjustable spout shank: adjustable center dimensions 	4792	188.55	1/2" CC	6
 DURALAST®				
 <ul style="list-style-type: none"> • deck thickness: 1/8" to 2-3/4" rough-in deck • adjustable spout shank: 10" - 24" center dimensions 	4793	213.55	1/2" CPVC, Crimp Ring PEX	6
	4794	203.60	1/2" Crimp Ring PEX, Cold Exp. PEX	6
 DURALOCK® DURALAST®				
 <ul style="list-style-type: none"> • deck thickness: 1/8" to 3-3/16" rough-in deck • Non-adjustable spout shank: 10" center dimensions 	4796	177.65	1/2" CC	6
	4797	181.10	1/2" CPVC, Crimp Ring PEX	6
	4798	181.10	1/2" Crimp Ring PEX, Cold Exp. PEX	6
 DURALAST®				
TWO-HANDLE ROMAN TUB VALVE WITH HANDSHOWER				
 <ul style="list-style-type: none"> • deck thickness: 1/8" to 2-5/8" rough-in deck • non-adj spout shank: adjustable center dim's 	9792	424.85	1/2" CC	6
 DURALAST®				
 <ul style="list-style-type: none"> • deck thickness: 1/8" to 2-5/8" rough-in deck • adj spout shank: 10" - 24" center dimensions 	9793	434.80	1/2" CPVC, Crimp Ring PEX	6
 DURALOCK® DURALAST®				
For more product details, reference page 464 in valve section.				
<p>HOW TO ORDER VALVES: PAGE 464</p> 				

FLARA™

















FLARA™ Collection

		MODEL	LIST	FINISH/CONNECT	CASE QTY
EXACTTEMP® VALVE ONLY TRIM - PREMIUM					
 <ul style="list-style-type: none"> • description: temperature control valve trim • requires: separate volume control valve • valve: sold separately  		TS4201	402.00	Chrome	3
		TS4201BN	603.00	Brushed Nickel	3
		TS4201NL	603.00	Polished Nickel	3
		TS4201BG	603.00	Brushed Gold	3
EXACTTEMP® THERMOSTATIC MIXING SHOWER VALVE - PREMIUM					
 <ul style="list-style-type: none"> • description: thermostatic rough-in valve • ports: four with adjustable temp. limit stops • check stops: included 		S3371	714.65	¾" IPS	6
HOW TO ORDER		 TRIM PART # +  VALVE PART # =  COMPLETE FAUCET			
VALVES: PAGE 465					

EXACTTEMP® VOLUME CONTROL VALVE TRIM - PREMIUM					
 <ul style="list-style-type: none"> • valve: sold separately  		TS4202	185.50	Chrome	6
		TS4202BN	278.40	Brushed Nickel	6
		TS4202NL	278.40	Polished Nickel	6
		TS4202BG	278.40	Brushed Gold	6
EXACTTEMP® VOLUME CONTROL SHOWER VALVE - PREMIUM					
 <ul style="list-style-type: none"> • includes: volume control 		S3600	181.70	¾" IPS	12
HOW TO ORDER		 TRIM PART # +  VALVE PART # =  COMPLETE FAUCET			
VALVES: PAGE 465					

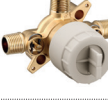





















FLARA™ Collection

		MODEL	LIST	FINISH/CONNECT	CASE QTY
M-CORE® 4-SERIES TUB/SHOWER TRIM - PREMIUM					
	<ul style="list-style-type: none"> • showerhead: single-function eco-performance rainshower • showerhead size: 6" diameter • tub spout length: 8 1/8" • tub spout connection type: slip fit • tub spout type: diverter • includes: thermostatic cartridge with volume and temperature control • valve: sold separately 	 1.75 GPM (6.65 L/min) max.			
		UTS4913EP	907.95	Chrome	4
		UTS4913EPBN	1231.55	Brushed Nickel	4
		UTS4913EPNL	1231.55	Polished Nickel	4
		UTS4913EPBG	1231.55	Brushed Gold	4
					
M-CORE® 4-SERIES SHOWER ONLY TRIM - PREMIUM					
	<ul style="list-style-type: none"> • showerhead: single-function eco-performance rainshower • showerhead size: 6" diameter • includes: thermostatic cartridge with volume and temperature control • valve: sold separately 	 1.75 GPM (6.65 L/min) max.			
		UTS4912EP	783.50	Chrome	4
		UTS4912EPBN	1032.20	Brushed Nickel	4
		UTS4912EPNL	1032.20	Polished Nickel	4
		UTS4912EPBG	1032.20	Brushed Gold	4
					
M-CORE® 4-SERIES VALVE ONLY TRIM - PREMIUM					
	<ul style="list-style-type: none"> • includes: thermostatic cartridge with volume and temperature control • valve: sold separately 	UTS4910	680.20	Chrome	3
		UTS4910BN	858.05	Brushed Nickel	3
		UTS4910NL	858.05	Polished Nickel	3
		UTS4910BG	858.05	Brushed Gold	3
					
M-CORE® MIXING SHOWER VALVE					
	<ul style="list-style-type: none"> • tub/shower or shower only application • ports: four with adj. temp. limit stops • included: test plug and cross flow plug 	U140CI	71.20	1/2" CC/IPS	6
		U140X	71.20	1/2" Crimp Ring PEX + CC/IPS Tub	6
		U140CX	71.20	1/2" Cold Exp. PEX + CC/IPS Tub	6
		U140V	87.20	1/2" CPVC + CC/IPS Tub	6
	<ul style="list-style-type: none"> • tub/shower or shower only application • ports: four with adj. temp. limit stops • quarter turn stops: included 	U140CIS	102.45	1/2" CC/IPS	6
		U140XS	102.45	1/2" Crimp Ring PEX + CC/IPS Tub	6
		U140CXS	102.45	1/2" Cold Exp. PEX + CC/IPS Tub	6
		U140VS	118.50	1/2" CPVC + CC/IPS Tub	6
	<ul style="list-style-type: none"> • tub/shower only application • ports: four with adj. temp. limit stops • tub outlet: pre-fabricated 1/2" copper tube • included: quarter turn stops and plugs 	U140X-PF	80.40	1/2" Crimp Ring PEX	6
		U140CX-PF	80.40	1/2" Cold Exp. PEX	6
	<ul style="list-style-type: none"> • tub/shower only application • ports: four with adj. temp. limit stops • tub outlet: pre-fabricated 1/2" copper tube • included: quarter turn stops and plugs 	U140XS-PF	111.70	1/2" Crimp Ring PEX	6
		U140CXS-PF	111.70	1/2" Cold Exp. PEX	6
	<ul style="list-style-type: none"> • shower only application • ports: three 	U130CI	71.20	1/2" CC/IPS	6
		U130X	71.20	1/2" Crimp Ring PEX	6
		U130CX	71.20	1/2" Cold Exp. PEX	6
	<ul style="list-style-type: none"> • shower only application • ports: three • quarter turn stops: included 	U130CIS	102.45	1/2" CC/IPS	6
		U130XS	102.45	1/2" Crimp Ring PEX	6
		U130CXS	102.45	1/2" Cold Exp. PEX	6
<p>Four port valves can be used with either Tub/Shower or Shower Only applications. Three port valves can ONLY be used with Shower Only applications. For more product details, reference pages 465-466 in valve section.</p>					
HOW TO ORDER VALVES: PAGES 465-466		 TRIM PART # +  VALVE PART # =  COMPLETE FAUCET			











FLARA™











MODEL LIST FINISH/CONNECT CASE QTY























M-CORE® 3-SERIES TUB/SHOWER TRIM - PREMIUM					
 <ul style="list-style-type: none"> • showerhead: single-function rainshower • showerhead size: 6" diameter • tub spout length: 8 1/8" • tub spout connection type: slip fit • tub spout type: diverter • includes: pressure balanced cartridge with volume and temperature control • valve: sold separately 	<p>2.5 GPM (9.5 L/min) max.</p>				
	UTS3913	772.95	Chrome	4	
	UTS3913BN	1096.55	Brushed Nickel	4	
	UTS3913NL	1096.55	Polished Nickel	4	
	UTS3913BG	1096.55	Brushed Gold	4	
	◆ 1.75 GPM (6.65 L/min) max.				
	UTS3913EP	772.95	Chrome	4	
	UTS3913EPBN	1096.55	Brushed Nickel	4	
	UTS3913EPNL	1096.55	Polished Nickel	4	
	UTS3913EPBG	1096.55	Brushed Gold	4	
M-CORE® 3-SERIES SHOWER ONLY TRIM - PREMIUM					
 <ul style="list-style-type: none"> • showerhead: single-function rainshower • showerhead size: 6" diameter • includes: pressure balanced cartridge with volume and temperature control • valve: sold separately 	<p>2.5 GPM (9.5 L/min) max.</p>				
	UTS3912	648.50	Chrome	4	
	UTS3912BN	897.20	Brushed Nickel	4	
	UTS3912NL	897.20	Polished Nickel	4	
	UTS3912BG	897.20	Brushed Gold	4	
	◆ 1.75 GPM (6.65 L/min) max.				
	UTS3912EP	648.50	Chrome	4	
	UTS3912EPBN	897.20	Brushed Nickel	4	
	UTS3912EPNL	897.20	Polished Nickel	4	
	UTS3912EPBG	897.20	Brushed Gold	4	
M-CORE® 3-SERIES VALVE ONLY TRIM - PREMIUM					
 <ul style="list-style-type: none"> • includes: pressure balanced cartridge with volume and temperature control • valve: sold separately 	UTS3911	545.20	Chrome	3	
	UTS3911BN	723.05	Brushed Nickel	3	
	UTS3911NL	723.05	Polished Nickel	3	
	UTS3911BG	723.05	Brushed Gold	3	
	M-CORE® MIXING SHOWER VALVE				
 <ul style="list-style-type: none"> • tub/shower or shower only application • ports: four with adj. temp. limit stops • included: test plug and cross flow plug 	U140CI	71.20	1/2" CC/IPS	6	
	U140X	71.20	1/2" Crimp Ring PEX + CC/IPS Tub	6	
	U140CX	71.20	1/2" Cold Exp. PEX + CC/IPS Tub	6	
	U140V	87.20	1/2" CPVC + CC/IPS Tub	6	
	 <ul style="list-style-type: none"> • tub/shower or shower only application • ports: four with adj. temp. limit stops • quarter turn stops: included 	U140CIS	102.45	1/2" CC/IPS	6
U140XS		102.45	1/2" Crimp Ring PEX + CC/IPS Tub	6	
U140CXS		102.45	1/2" Cold Exp. PEX + CC/IPS Tub	6	
U140VS		118.50	1/2" CPVC + CC/IPS Tub	6	
 <ul style="list-style-type: none"> • tub/shower only application • ports: four with adj. temp. limit stops • tub outlet: pre-fabricated 1/2" copper tube • included: quarter turn stops and plugs 		U140X-PF	80.40	1/2" Crimp Ring PEX	6
	U140CX-PF	80.40	1/2" Cold Exp. PEX	6	
 <ul style="list-style-type: none"> • tub/shower only application • ports: four with adj. temp. limit stops • tub outlet: pre-fabricated 1/2" copper tube • included: quarter turn stops and plugs 	U140XS-PF	111.70	1/2" Crimp Ring PEX	6	
	U140CXS-PF	111.70	1/2" Cold Exp. PEX	6	
 <ul style="list-style-type: none"> • shower only application • ports: three 	U130CI	71.20	1/2" CC/IPS	6	
	U130X	71.20	1/2" Crimp Ring PEX	6	
	U130CX	71.20	1/2" Cold Exp. PEX	6	
 <ul style="list-style-type: none"> • shower only application • ports: three • quarter turn stops: included 	U130CIS	102.45	1/2" CC/IPS	6	
	U130XS	102.45	1/2" Crimp Ring PEX	6	
	U130CXS	102.45	1/2" Cold Exp. PEX	6	
<p>Four port valves can be used with either Tub/Shower or Shower Only applications. Three port valves can ONLY be used with Shower Only applications. For more product details, reference pages 465-466 in valve section.</p>					
<p>HOW TO ORDER VALVES: PAGES 465-466</p>	 <p>TRIM PART #</p>	+	 <p>VALVE PART #</p>	=	 <p>COMPLETE FAUCET</p>

FLARA™

FLARA™ Collection

















		MODEL	LIST	FINISH/CONNECT	CASE QTY			
M-CORE® 3-SERIES WITH INTEGRATED TRANSFER VALVE TRIM - PREMIUM								
 <ul style="list-style-type: none"> • includes: pressure balanced cartridge with volume and temperature control • valve: sold separately  		UTS2411	508.65	Chrome	4			
		UTS2411BN	737.50	Brushed Nickel	4			
		UTS2411NL	737.50	Polished Nickel	4			
		UTS2411BG	737.50	Brushed Gold	4			
M-CORE® WITH INTEGRATED TRANSFER VALVE								
Three Function (2 independent/1 shared) OR Six Function (3 independent/3 shared) - plumbing configuration page 472								
 <ul style="list-style-type: none"> • ports: four with adj. temp. limit stops • check stops: included 		U362CIS	265.40	1/2" CC/IPS	6			
		U362CXS	265.40	1/2" Cold Exp. PEX	6			
		U362XS	265.40	1/2" Crimp Ring PEX	6			
Two Independent Functions OR Three Independent Functions - plumbing configurations page 472								
 <ul style="list-style-type: none"> • ports: four with adj. temp. limit stops • check stops: included 		U232CIS	265.40	1/2" CC/IPS	6			
		U232CXS	265.40	1/2" Cold Exp. PEX	6			
		U232XS	265.40	1/2" Crimp Ring PEX	6			
For more product details, reference page 466 in valve section. See page 472 for plumbing configurations.								
HOW TO ORDER VALVES: PAGE 466		TRIM PART #	+		VALVE PART #	=		COMPLETE FAUCET

M-CORE® TRANSFER VALVE TRIM - PREMIUM								
 <ul style="list-style-type: none"> • use with the M-CORE® transfer valve • valve: sold separately  		UTS4911	330.70	Chrome	12			
		UTS4911BN	449.10	Brushed Nickel	12			
		UTS4911NL	449.10	Polished Nickel	12			
		UTS4911BG	449.10	Brushed Gold	12			
M-CORE® TRANSFER VALVE								
Three Function (2 independent/1 shared) OR Six Function (3 independent/3 shared) - plumbing configuration page 472								
 <ul style="list-style-type: none"> • number of functions: three or six • ports: four 		U361CI	149.70	1/2" CC/IPS	6			
		U361CX	149.70	1/2" Cold Exp. PEX	6			
		U361X	149.70	1/2" Crimp Ring PEX	6			
Two Independent Functions OR Three Independent Functions - plumbing configurations page 472								
 <ul style="list-style-type: none"> • number of functions: two or three • ports: four 		U231CI	149.70	1/2" CC/IPS	6			
		U231CX	149.70	1/2" Cold Exp. PEX	6			
		U231X	149.70	1/2" Crimp Ring PEX	6			
For more product details, reference page 466 in valve section. See page 472 for plumbing configurations.								
HOW TO ORDER VALVES: PAGE 466		TRIM PART #	+		VALVE PART #	=		COMPLETE FAUCET

		MODEL	LIST	FINISH/CONNECT	CASE QTY
M-CORE® 2-SERIES TUB/SHOWER TRIM - PREMIUM					
 <ul style="list-style-type: none"> • showerhead: single-function eco-performance rainshower • showerhead size: 6" diameter • tub spout length: 8 1/8" • tub spout connection type: slip fit • tub spout type: diverter • includes: pressure balanced cartridge with temperature control • valve: sold separately 			1.75 GPM (6.65 L/min) max.		
		UTS2913EP	703.10	Chrome	4
		UTS2913EPBN	979.10	Brushed Nickel	4
		UTS2913EPNL	979.10	Polished Nickel	4
		UTS2913EPBG	979.10	Brushed Gold	4
					
M-CORE® 2-SERIES SHOWER ONLY TRIM - PREMIUM					
 <ul style="list-style-type: none"> • showerhead: single-function eco-performance rainshower • showerhead size: 6" diameter • includes: pressure balanced cartridge with temperature control • valve: sold separately 			1.75 GPM (6.65 L/min) max.		
		UTS2912EP	585.15	Chrome	4
		UTS2912EPBN	802.25	Brushed Nickel	4
		UTS2912EPNL	802.25	Polished Nickel	4
		UTS2912EPBG	802.25	Brushed Gold	4
					
M-CORE® 2-SERIES VALVE ONLY TRIM - PREMIUM					
 <ul style="list-style-type: none"> • includes: pressure balanced cartridge with temperature control • valve: sold separately 		UTS2911	437.85	Chrome	3
		UTS2911BN	581.30	Brushed Nickel	3
		UTS2911NL	581.30	Polished Nickel	3
		UTS2911BG	581.30	Brushed Gold	3
					
M-CORE® MIXING SHOWER VALVE					
 <ul style="list-style-type: none"> • tub/shower or shower only application • ports: four with adj. temp. limit stops • included: test plug and cross flow plug 		U140CI	71.20	1/2" CC/IPS	6
		U140X	71.20	1/2" Crimp Ring PEX + CC/IPS Tub	6
		U140CX	71.20	1/2" Cold Exp. PEX + CC/IPS Tub	6
		U140V	87.20	1/2" CPVC + CC/IPS Tub	6
					
 <ul style="list-style-type: none"> • tub/shower or shower only application • ports: four with adj. temp. limit stops • quarter turn stops: included 		U140CIS	102.45	1/2" CC/IPS	6
		U140XS	102.45	1/2" Crimp Ring PEX + CC/IPS Tub	6
		U140CXS	102.45	1/2" Cold Exp. PEX + CC/IPS Tub	6
		U140VS	118.50	1/2" CPVC + CC/IPS Tub	6
					
 <ul style="list-style-type: none"> • tub/shower only application • ports: four with adj. temp. limit stops • tub outlet: pre-fabricated 1/2" copper tube • included: quarter turn stops and plugs 		U140X-PF	80.40	1/2" Crimp Ring PEX	6
		U140CX-PF	80.40	1/2" Cold Exp. PEX	6
					
 <ul style="list-style-type: none"> • tub/shower only application • ports: four with adj. temp. limit stops • tub outlet: pre-fabricated 1/2" copper tube • included: quarter turn stops and plugs 		U140XS-PF	111.70	1/2" Crimp Ring PEX	6
		U140CXS-PF	111.70	1/2" Cold Exp. PEX	6
					
 <ul style="list-style-type: none"> • shower only application • ports: three 		U130CI	71.20	1/2" CC/IPS	6
		U130X	71.20	1/2" Crimp Ring PEX	6
		U130CX	71.20	1/2" Cold Exp. PEX	6
					
 <ul style="list-style-type: none"> • shower only application • ports: three • quarter turn stops: included 		U130CIS	102.45	1/2" CC/IPS	6
		U130XS	102.45	1/2" Crimp Ring PEX	6
		U130CXS	102.45	1/2" Cold Exp. PEX	6
					
<p>Four port valves can be used with either Tub/Shower or Shower Only applications. Three port valves can ONLY be used with Shower Only applications. For more product details, reference pages 465-466 in valve section.</p>					
HOW TO ORDER VALVES: PAGES 465-466		 TRIM PART #   VALVE PART #   COMPLETE FAUCET			



FLARA™ Collection

		MODEL	LIST	FINISH/CONNECT	CASE QTY	
POSI-TEMP® TUB/SHOWER TRIM - PREMIUM						
 <ul style="list-style-type: none"> • showerhead: single-function rainshower • showerhead size: 6" diameter • tub spout length: 8 1/8" • tub spout connection type: slip fit • tub spout type: diverter • valve: sold separately 		2.5 GPM (9.5 L/min) max.				
		TS2913	552.10	Chrome	4	
		TS2913BN	828.05	Brushed Nickel	4	
		TS2913NL	828.05	Polished Nickel	4	
		TS2913BG	828.05	Brushed Gold	4	
		1.75 GPM (6.65 L/min) max.				
		TS2913EP	552.10	Chrome	4	
		TS2913EPBN	828.05	Brushed Nickel	4	
		TS2913EPBG	828.05	Brushed Gold	4	
		TS2913EPNL	828.05	Polished Nickel	4	
POSI-TEMP® SHOWER ONLY TRIM - PREMIUM						
 <ul style="list-style-type: none"> • showerhead: single-function rainshower • showerhead size: 6" diameter • valve: sold separately 		2.5 GPM (9.5 L/min) max.				
		TS2912	434.15	Chrome	4	
		TS2912BN	651.15	Brushed Nickel	4	
		TS2912NL	651.15	Polished Nickel	4	
		TS2912BG	651.15	Brushed Gold	4	
		1.75 GPM (6.65 L/min) max.				
		TS2912EP	434.15	Chrome	4	
		TS2912EPBN	651.15	Brushed Nickel	4	
		TS2912EPBG	651.15	Brushed Gold	4	
		TS2912EPNL	651.15	Polished Nickel	4	
POSI-TEMP® VALVE ONLY TRIM - PREMIUM						
 <ul style="list-style-type: none"> • valve: sold separately 		TS2911	286.85	Chrome	3	
		TS2911BN	430.20	Brushed Nickel	3	
		TS2911NL	430.20	Polished Nickel	3	
		TS2911BG	430.20	Brushed Gold	3	
	POSI-TEMP® SHOWER MIXING VALVES					
 <ul style="list-style-type: none"> • tub/shower or shower only application • ports: four with adjustable temp. limit stops • test plug: included 		2520 ◆	156.10	1/2" CC	6	
		2510 ◆	156.10	1/2" IPS	6	
 <ul style="list-style-type: none"> • tub/shower or shower only application • ports: four with adjustable temp. limit stops • quarter turn stops: included • test plug: included 		2570 ◆	189.55	1/2" CC	6	
		2590 ◆	189.55	1/2" IPS	6	
		2580 ◆	156.10	1/2" Crimp ring PEX	6	
	 <ul style="list-style-type: none"> • tub/shower only application • ports: four with adjustable temp. limit stops • quarter turn stops: included • test plug: included 		2360PF	208.45	1/2" Crimp Ring PEX	3
		2385PF	208.45	1/2" Cold Exp. PEX	3	
 <ul style="list-style-type: none"> • shower only application • ports: three with adjustable temp. limit stops • quarter turn stops: included • test plug: included 		2326PF	201.20	1/2" Crimp Ring PEX	6	
		2328PF	201.20	1/2" Cold Exp. PEX	6	
<p>Four port valves can be used with either Tub/Shower or Shower Only applications. Three port valves can ONLY be used with Shower Only applications. For more product details, reference page 467-468 in valve section.</p>						
<p>HOW TO ORDER VALVES: PAGES 467-470</p>		 <p>TRIM PART #</p>	+	 <p>VALVE PART #</p>	=	 <p>COMPLETE FAUCET</p>

FLARA™

Moen® bath accessories CANNOT be combined with Moen faucet parts on a Purchase Order.

A PERFECT MATCH

A line of perfectly matching accessories - including tank levers and towel bars - allow for a completely cohesive look in the bath.

MODEL NUMBER	LIST EACH	DESCRIPTION	QTY
PREMIUM			
Chrome (CH)			
YB0301CH	90.60	Tank Lever	24
YB0303CH	69.45	Double Robe Hook	24
YB0305CH	18.25	Drawer Knob	48
YB0307CH	36.60	Drawer Pull	48
Ⓟ YB0308CH	127.80	Pivoting Paper Holder	6
YB0318CH	147.05	18" Towel Bar	6
YB0322CH	142.55	24" Double Towel Bar	6
YB0324CH	152.10	24" Towel Bar	6
YB0386CH	102.70	Hand Towel Bar	6
YB0390CH	141.20	Vanity Shelf	6
Ⓟ YB0392CH	347.60	Mirror	1
Brushed Nickel (BN)			
YB0301BN	117.75	Tank Lever	24
YB0303BN	90.35	Double Robe Hook	24
YB0305BN	23.75	Drawer Knob	48
YB0307BN	47.65	Drawer Pull	48
Ⓟ YB0308BN	166.05	Pivoting Paper Holder	6
YB0318BN	191.05	18" Towel Bar	6
YB0322BN	185.25	24" Double Towel Bar	6
YB0324BN	197.80	24" Towel Bar	6
YB0386BN	133.50	Hand Towel Bar	6
YB0390BN	183.50	Vanity Shelf	6
Ⓟ YB0392BN	417.05	Mirror	1
Polished Nickel (NL)			
YB0301NL	129.55	Tank Lever	24
YB0303NL	99.30	Double Robe Hook	24
YB0305NL	20.10	Drawer Knob	48
YB0307NL	52.40	Drawer Pull	48
Ⓟ YB0308NL	182.70	Pivoting Paper Holder	6
YB0318NL	210.15	18" Towel Bar	6
YB0322NL	203.90	24" Double Towel Bar	6
YB0324NL	217.50	24" Towel Bar	6
YB0386NL	146.90	Hand Towel Bar	6
YB0390NL	201.80	Vanity Shelf	6
Ⓟ YB0392NL	458.80	Mirror	1
Brushed Gold (BG)			
YB0301BG	141.35	Tank Lever	24
YB0303BG	108.40	Double Robe Hook	24
YB0305BG	28.50	Drawer Knob	48
YB0307BG	57.20	Drawer Pull	48
Ⓟ YB0308BG	199.35	Pivoting Paper Holder	6
YB0318BG	229.35	18" Towel Bar	6
YB0322BG	222.45	24" Double Towel Bar	6
YB0324BG	237.35	24" Towel Bar	6
YB0386BG	160.25	Hand Towel Bar	6
YB0390BG	220.15	Vanity Shelf	6
Ⓟ YB0392BG	500.45	Mirror	1

Ⓟ Denotes pivoting paper holder and mirror



Tank Lever
YB0301



Double Robe Hook
YB0303



Pivoting Paper Holder
YB0308 | Ⓟ



Hand Towel Bar
YB0386



18" Towel Bar
YB0318



24" Double Towel Bar
YB0322

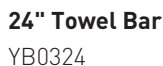

24" Towel Bar
YB0324



Drawer Knob
YB0305



Drawer Pull
YB0307



Vanity Shelf
YB0390



Mirror
YB0392 | Ⓟ

List price is per each (unless otherwise noted).
Product can be ordered by case quantity or individually.
For more information on ordering bath accessories, contact Moen Bath Accessory Customer Service at 800-882-0116, contact your local Moen sales representative, or visit us at www.moen.com.





GRAB BARS

MODEL NUMBER	LIST EACH	DESCRIPTION	QTY
--------------	-----------	-------------	-----

PREMIUM

1 1/4" • Chrome (CH)

YG0312CH	210.00	12" Designer Grab Bar	6
YG0318CH	219.45	18" Designer Grab Bar	6
YG0324CH	229.30	24" Designer Grab Bar	6
YG0336CH	261.00	36" Designer Grab Bar	6
YG0342CH	384.05	42" Designer Grab Bar	6

1 1/4" • Brushed Nickel (BN)

YG0312BN	272.95	12" Designer Grab Bar	6
YG0318BN	285.25	18" Designer Grab Bar	6
YG0324BN	297.95	24" Designer Grab Bar	6
YG0336BN	339.30	36" Designer Grab Bar	6
YG0342BN	499.25	42" Designer Grab Bar	6

1 1/4" • Brushed Gold (BG)

YG0312BG	327.60	12" Designer Grab Bar	6
YG0318BG	342.25	18" Designer Grab Bar	6
YG0324BG	357.60	24" Designer Grab Bar	6
YG0336BG	407.15	36" Designer Grab Bar	6
YG0342BG	599.15	42" Designer Grab Bar	6

1 1/4" • Polished Nickel (NL)

YG0312NL	300.25	12" Designer Grab Bar	6
YG0318NL	313.80	18" Designer Grab Bar	6
YG0324NL	327.85	24" Designer Grab Bar	6
YG0336NL	373.20	36" Designer Grab Bar	6
YG0342NL	549.20	42" Designer Grab Bar	6

SECUREMOUNT™

- SecureMount™ Grab Bars are manufactured with an innovative flange design that makes it easy to connect to the stud at multiple points.
- Tested to withstand 500lbs.
- To install grab bars securely without studs, use SecureMount™ Anchors. Sold separately.



24" Designer Grab Bar

YG0324



LIGHTING

MODEL NUMBER LIST EACH DESCRIPTION QTY

PREMIUM

Chrome (CH)

YB0361CH	232.80	One Globe Bath Light	2
YB0362CH	325.65	Two Globe Bath Light	2
YB0363CH	404.50	Three Globe Bath Light	2
YB0364CH	505.60	Four Globe Bath Light	2

Brushed Nickel (BN)

YB0361BN	302.60	One Globe Bath Light	2
YB0362BN	423.35	Two Globe Bath Light	2
YB0363BN	525.80	Three Globe Bath Light	2
YB0364BN	657.30	Four Globe Bath Light	2

Brushed Gold (BG)

YB0361BG	363.10	One Globe Bath Light	2
YB0362BG	508.10	Two Globe Bath Light	2
YB0363BG	630.95	Three Globe Bath Light	2
YB0364BG	788.60	Four Globe Bath Light	2

Polished Nickel (NL)

YB0361NL	332.85	One Globe Bath Light	2
YB0362NL	465.75	Two Globe Bath Light	2
YB0363NL	578.35	Three Globe Bath Light	2
YB0364NL	722.95	Four Globe Bath Light	2

Replacement Globe

YB0369	40.10	Replacement Globe	3
--------	-------	-------------------	---



One Globe Bath Light

YB0361



Two Globe Bath Light

YB0362



Three Globe Bath Light

YB0363



Four Globe Bath Light

YB0364



Replacement Globe





















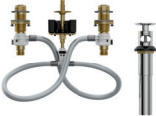







YB0369

FLARATM





















Bulbs not included.
List price is per each (unless otherwise noted).
Product can be ordered by case quantity or individually.
All Flara™ lighting Fixtures can be mounted facing either upward or downward.

COLINET™ Collection





















		MODEL	LIST	FINISH/CONNECT	CASE QTY
ONE-HANDLE BATHROOM FAUCET - PREMIUM					
 <ul style="list-style-type: none"> • application: one hole • supply lines: flexible • connection: 3/8" compression • drain assembly: metal • drain assembly type: spring loaded pop-up <p> DURALAST®</p>	<p> 1.2 GPM (4.5L/min) max.</p>	S44101	596.90	Chrome	3
		S44101BN	775.95	Brushed Nickel	3
		S44101BL	835.65	Matte Black	3
		S44101BG	865.50	Brushed Gold	3
	TWO-HANDLE WIDESPREAD BATHROOM FAUCET TRIM - PREMIUM				
 <ul style="list-style-type: none"> • application: three hole • center dimensions: 8" - 16" center • drain assembly: metal with lift rod • valve: sold separately <p> </p>	<p> 1.2 GPM (4.5L/min) max.</p>	TS44102	534.30	Chrome	3
		TS44102BN	694.60	Brushed Nickel	3
		TS44102BL	748.05	Matte Black	3
		TS44102BG	774.75	Brushed Gold	3
 <ul style="list-style-type: none"> • application: three hole • center dimensions: 8" - 16" center • drain assembly: metal with lift rod • valve: sold separately <p></p>	<p> 1.2 GPM (4.5L/min) max.</p>	TS44103	559.80	Chrome	3
		TS44103BN	727.75	Brushed Nickel	3
		TS44103BL	783.75	Matte Black	3
		TS44103BG	811.75	Brushed Gold	3
WIDESPREAD FAUCET VALVE					
 <ul style="list-style-type: none"> • application: three hole • center dimensions: 8" - 16" center • drain assembly: metal with lift rod <p> DURALOCK® DURALAST®</p>		9000♦	162.15	1/2" IPS	6
<p>HOW TO ORDER VALVES: PAGE 463</p> <p>  TRIM PART # +  VALVE PART # =  COMPLETE FAUCET </p>					
TWO-HANDLE WALLMOUNT BATHROOM FAUCET TRIM - PREMIUM					
 <ul style="list-style-type: none"> • application: three hole • center dimensions: 8" center • drain assembly: 140780 sold separately • valve: sold separately <p> </p>	<p> 1.2 GPM (4.5L/min) max.</p>	TS44104	561.10	Chrome	3
		TS44104BN	729.40	Brushed Nickel	3
		TS44104BL	785.50	Matte Black	3
		TS44104BG	813.55	Brushed Gold	3
 <ul style="list-style-type: none"> • application: three hole • center dimensions: 8" center • drain assembly: 140780 sold separately • valve: sold separately <p></p>	<p> 1.2 GPM (4.5L/min) max.</p>	TS44105	586.60	Chrome	3
		TS44105BN	762.55	Brushed Nickel	3
		TS44105BL	821.20	Matte Black	3
		TS44105BG	850.55	Brushed Gold	3
TWO-HANDLE WALLMOUNT FAUCET VALVE					
 <ul style="list-style-type: none"> • application: three hole • center dimensions: 8" center • drain assembly: 140780 sold separately • includes: mounting brackets <p> DURALAST®</p>		9700	229.35	1/2" CC	3
<p>HOW TO ORDER VALVES: PAGE 463</p> <p>  TRIM PART # +  VALVE PART # =  COMPLETE FAUCET </p>					
OPTION: DRAIN ASSEMBLY					
 <ul style="list-style-type: none"> • drain assembly: metal • drain assembly type: spring loaded pop-up • drain assembly size: 1-1/4" • drain assembly: 1-1/4" non-overflow 		140780	76.80	Chrome	12
		140780BN	107.05	Brushed Nickel	12
		140780BL	120.90	Matte Black	12
		140780BG	107.05	Brushed Gold	12

COLINET™

		MODEL	LIST	FINISH/CONNECT	CASE QTY	
FREESTANDING TUB FILLER TRIM - PREMIUM						
 <ul style="list-style-type: none"> • application: one hole • showerhead type: handshower • handshower functions: one-function • handshower flow rate: 1.75 gpm (6.65 L/min) max. • spout reach: 11.10" • mounting kit: sold separately  		S44507	2191.75	Chrome	1	
		S44507BN	2958.80	Brushed Nickel	1	
		S44507BG	2958.80	Brushed Gold	1	
		S44507BL	3254.80	Matte Black	1	
FREESTANDING TUB FILLER VALVE AND MOUNTING KIT - PREMIUM						
 <ul style="list-style-type: none"> • description: single riser floor joist mounting kit • application: one hole • quarter turn stops: included 		TS50100	400.90	1/2" CC, NPT	2	
	 <ul style="list-style-type: none"> • description: single riser concrete mounting kit • application: one hole • connection size: 1/2" 		TS50110	325.95	1/2" CC, NPT	2
HOW TO ORDER VALVES: PAGE 463		 TRIM PART #	+	 VALVE PART #	=	 COMPLETE FAUCET

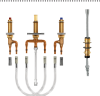







ONE-HANDLE WALLMOUNT TUB FILLER TRIM - PREMIUM						
 <ul style="list-style-type: none"> • application: two hole • connection: 1/2" slip fit • tub spout type: non diverter • spout reach: 10.00" • includes: high flow volume control cartridge • WMV130 series valve kit: sold separately  		WTS44501	812.05	Chrome	3	
		WTS44501BN	1112.50	Brushed Nickel	3	
		WTS44501BG	1112.50	Brushed Gold	3	
		WTS44501BL	1223.75	Matte Black	3	
ONE-HANDLE WALLMOUNT TUB FILLER VALVE KIT						
 <ul style="list-style-type: none"> • application: two hole with adj. center dimensions • ports: three • quarter turn stops: included • includes: test plug • includes: spout manifold 		WMV130CIS	151.05	1/2" CC/IPS	6	
		WMV130XS	151.05	1/2" Crimp Ring PEX	6	
		WMV130CXS	151.05	1/2" Cold Exp. PEX	6	
HOW TO ORDER VALVES: PAGE 463		  TRIM PART #	+	 VALVE PART #	=	 COMPLETE FAUCET









COLINET™ Collection

	MODEL	LIST	FINISH/CONNECT	CASE QTY		
TWO-HANDLE ROMAN TUB TRIM - PREMIUM						
 <ul style="list-style-type: none"> • application: three hole • spout reach: 8.00" • valve: sold separately 	TS44503	990.05	Chrome	3		
	TS44503BN	1435.55	Brushed Nickel	3		
	TS44503BG	1435.55	Brushed Gold	3		
	TS44503BL	1579.05	Matte Black	3		
 <ul style="list-style-type: none"> • application: three hole • spout reach: 8.00" • valve: sold separately 	TS44505	1015.55	Chrome	3		
	TS44505BN	1461.05	Brushed Nickel	3		
	TS44505BG	1461.05	Brushed Gold	3		
	TS44505BL	1604.60	Matte Black	3		
TWO-HANDLE ROMAN TUB TRIM WITH HANDSHOWER - PREMIUM						
 <ul style="list-style-type: none"> • application: four hole • showerhead type: handshower • handshower flow rate: 1.75 gpm (6.65 L/min) max. • spray functions: one-function • spout reach: 8.00" • valve: sold separately 	TS44504	1198.50	Chrome	3		
	TS44504BN	1737.90	Brushed Nickel	3		
	TS44504BG	1737.90	Brushed Gold	3		
	TS44504BL	1911.70	Matte Black	3		
 <ul style="list-style-type: none"> • application: four hole • showerhead type: handshower • handshower flow rate: 1.75 gpm (6.65 L/min) max. • spray functions: one-function • spout reach: 8.00" • valve: sold separately 	TS44506	1224.00	Chrome	3		
	TS44506BN	1763.40	Brushed Nickel	3		
	TS44506BG	1763.40	Brushed Gold	3		
	TS44506BL	1937.20	Matte Black	3		
TWO-HANDLE ROMAN TUB VALVE						
 <ul style="list-style-type: none"> • deck thickness: 1/8" to 3-3/8" rough-in deck • adjustable spout shank: adjustable center dimensions  DURALAST®	4792	188.55	1/2" CC	6		
 <ul style="list-style-type: none"> • deck thickness: 1/8" to 2-3/4" rough-in deck • adjustable spout shank: 10" - 24" center dimensions  DURALOCK® DURALAST®	4793	213.55	1/2" CPVC, Crimp Ring PEX	6		
	4794	203.60	1/2" Crimp Ring PEX, Cold Exp. PEX	6		
 <ul style="list-style-type: none"> • deck thickness: 1/8" to 3-3/16" rough-in deck • Non-adjustable spout shank: 10" center dimensions  DURALAST®	4796	177.65	1/2" CC	6		
	4797	181.10	1/2" CPVC, Crimp Ring PEX	6		
	4798	181.10	1/2" Crimp Ring PEX, Cold Exp. PEX	6		
TWO-HANDLE ROMAN TUB VALVE WITH HANDSHOWER						
 <ul style="list-style-type: none"> • deck thickness: 1/8" to 2-5/8" rough-in deck • non-adj spout shank: adjustable center dim's  DURALAST®	9792	424.85	1/2" CC	6		
 <ul style="list-style-type: none"> • deck thickness: 1/8" to 2-5/8" rough-in deck • adj spout shank: 10" - 24" center dimensions  DURALOCK® DURALAST®	9793	434.80	1/2" CPVC, Crimp Ring PEX	6		
For more product details, reference page 464 in valve section.						
HOW TO ORDER VALVES: PAGE 464		 TRIM PART #	+	 VALVE PART #	=	 COMPLETE FAUCET



















COLINET™

COLINET™ Collection

























		MODEL	LIST	FINISH/CONNECT	CASE QTY	
EXACTTEMP® VALVE ONLY TRIM - PREMIUM						
 <ul style="list-style-type: none"> • description: temperature control valve trim • requires: separate volume control valve • valve: sold separately  		TS44401	384.50	Chrome	3	
		TS44401BN	576.70	Brushed Nickel	3	
		TS44401BG	576.70	Brushed Gold	3	
		TS44401BL	634.45	Matte Black	3	
EXACTTEMP® THERMOSTATIC MIXING SHOWER VALVE - PREMIUM						
 <ul style="list-style-type: none"> • description: thermostatic rough-in valve • ports: four with adjustable temp. limit stops • check stops: included 		S3371	714.65	¾" IPS	6	
HOW TO ORDER		 TRIM PART #	+	 VALVE PART #	=	 COMPLETE FAUCET
VALVES: PAGE 465						

EXACTTEMP® VOLUME CONTROL VALVE TRIM - PREMIUM						
 <ul style="list-style-type: none"> • valve: sold separately  		TS44402	177.50	Chrome	6	
		TS44402BN	266.30	Brushed Nickel	6	
		TS44402BG	266.30	Brushed Gold	6	
		TS44402BL	292.90	Matte Black	6	
EXACTTEMP® VOLUME CONTROL SHOWER VALVE - PREMIUM						
 <ul style="list-style-type: none"> • includes: volume control 		S3600	181.70	¾" IPS	12	
HOW TO ORDER		 TRIM PART #	+	 VALVE PART #	=	 COMPLETE FAUCET
VALVES: PAGE 465						











COLINET™ Collection











		MODEL	LIST	FINISH/CONNECT	CASE QTY
M-CORE® 4-SERIES TUB/SHOWER TRIM - PREMIUM					
	<ul style="list-style-type: none"> • showerhead: single-function eco-performance rainshower • showerhead size: 10" diameter • type of function: one function • tub spout length: 9" • tub spout connection type: slip fit • tub spout type: diverter • includes: thermostatic cartridge with volume and temperature control • valve: sold separately 	1.75 GPM (6.65 L/min) max.			
		UTS444303EP	873.15	Chrome	3
		UTS444303EPBN	1182.25	Brushed Nickel	3
		UTS444303EPBG	1182.25	Brushed Gold	3
		UTS444303EPBL	1286.95	Matte Black	3
M-CORE® 4-SERIES SHOWER ONLY TRIM - PREMIUM					
	<ul style="list-style-type: none"> • showerhead type: eco-performance rainshower • showerhead size: 10" diameter • type of function: one function • includes: thermostatic cartridge with volume and temperature control • valve: sold separately 	1.75 GPM (6.65 L/min) max.			
		UTS444302EP	754.35	Chrome	3
		UTS444302EPBN	991.75	Brushed Nickel	3
		UTS444302EPBG	991.75	Brushed Gold	3
		UTS444302EPBL	1077.50	Matte Black	3
M-CORE® 4-SERIES VALVE ONLY TRIM - PREMIUM					
	<ul style="list-style-type: none"> • includes: thermostatic cartridge with volume and temperature control • valve: sold separately 	UTS444301	655.65	Chrome	3
		UTS444301BN	825.50	Brushed Nickel	3
		UTS444301BG	825.50	Brushed Gold	3
		UTS444301BL	894.50	Matte Black	3
		M-CORE® MIXING SHOWER VALVE			
	<ul style="list-style-type: none"> • tub/shower or shower only application • ports: four with adj. temp. limit stops • included: test plug and cross flow plug 	U140CI	71.20	1/2" CC/IPS	6
		U140X	71.20	1/2" Crimp Ring PEX + CC/IPS Tub	6
		U140CX	71.20	1/2" Cold Exp. PEX + CC/IPS Tub	6
		U140V	87.20	1/2" CPVC + CC/IPS Tub	6
	<ul style="list-style-type: none"> • tub/shower or shower only application • ports: four with adj. temp. limit stops • quarter turn stops: included 	U140CIS	102.45	1/2" CC/IPS	6
		U140XS	102.45	1/2" Crimp Ring PEX + CC/IPS Tub	6
		U140CXS	102.45	1/2" Cold Exp. PEX + CC/IPS Tub	6
		U140VS	118.50	1/2" CPVC + CC/IPS Tub	6
	<ul style="list-style-type: none"> • tub/shower only application • ports: four with adj. temp. limit stops • tub outlet: pre-fabricated 1/2" copper tube • included: quarter turn stops and plugs 	U140X-PF	80.40	1/2" Crimp Ring PEX	6
		U140CX-PF	80.40	1/2" Cold Exp. PEX	6
	<ul style="list-style-type: none"> • tub/shower only application • ports: four with adj. temp. limit stops • tub outlet: pre-fabricated 1/2" copper tube • included: quarter turn stops and plugs 	U140XS-PF	111.70	1/2" Crimp Ring PEX	6
		U140CXS-PF	111.70	1/2" Cold Exp. PEX	6
	<ul style="list-style-type: none"> • shower only application • ports: three 	U130CI	71.20	1/2" CC/IPS	6
		U130X	71.20	1/2" Crimp Ring PEX	6
		U130CX	71.20	1/2" Cold Exp. PEX	6
	<ul style="list-style-type: none"> • shower only application • ports: three • quarter turn stops: included 	U130CIS	102.45	1/2" CC/IPS	6
		U130XS	102.45	1/2" Crimp Ring PEX	6
		U130CXS	102.45	1/2" Cold Exp. PEX	6
<p>Four port valves can be used with either Tub/Shower or Shower Only applications. Three port valves can ONLY be used with Shower Only applications. For more product details, reference pages 465-466 in valve section.</p>					
<p>HOW TO ORDER VALVES: PAGES 465-466</p>					

















COLINET™

		MODEL	LIST	FINISH/CONNECT	CASE QTY	
M-CORE® 3-SERIES TUB/SHOWER TRIM - PREMIUM						
 <ul style="list-style-type: none"> • showerhead: single-function rainshower • showerhead size: 10" diameter • tub spout length: 9" • tub spout connection type: slip fit • tub spout type: diverter • includes: pressure balanced cartridge with volume and temperature control • valve: sold separately 		2.5 GPM (9.5 L/min) max.				
		UTS344303	738.15	Chrome	3	
		UTS344303BN	1047.25	Brushed Nickel	3	
		UTS344303BG	1047.25	Brushed Gold	3	
		UTS344303BL	1151.95	Matte Black	3	
 <ul style="list-style-type: none"> • showerhead: single-function eco-performance rainshower • showerhead size: 10" diameter • tub spout length: 9" • tub spout connection type: slip fit • tub spout type: diverter • includes: pressure balanced cartridge with volume and temperature control • valve: sold separately 		1.75 GPM (6.65 L/min) max.				
		UTS344303EP	738.15	Chrome	3	
		UTS344303EPBN	1047.25	Brushed Nickel	3	
		UTS344303EPBG	1047.25	Brushed Gold	3	
		UTS344303EPBL	1151.95	Matte Black	3	
M-CORE® 3-SERIES SHOWER ONLY TRIM - PREMIUM						
 <ul style="list-style-type: none"> • showerhead: single-function rainshower • showerhead size: 10" diameter • includes: pressure balanced cartridge with volume and temperature control • valve: sold separately 		2.5 GPM (9.5 L/min) max.				
		UTS344302	619.35	Chrome	3	
		UTS344302BN	856.75	Brushed Nickel	3	
		UTS344302BG	856.75	Brushed Gold	3	
		UTS344302BL	942.50	Matte Black	3	
 <ul style="list-style-type: none"> • showerhead: single-function rainshower • showerhead size: 10" diameter • includes: pressure balanced cartridge with volume and temperature control • valve: sold separately 		1.75 GPM (6.65 L/min) max.				
		UTS344302EP	619.35	Chrome	3	
		UTS344302EPBN	856.75	Brushed Nickel	3	
		UTS344302EPBG	856.75	Brushed Gold	3	
		UTS344302EPBL	942.50	Matte Black	3	
M-CORE® 3-SERIES VALVE ONLY TRIM - PREMIUM						
 <ul style="list-style-type: none"> • includes: pressure balanced cartridge with volume and temperature control • valve: sold separately 		UTS344301	520.65	Chrome	3	
		UTS344301BN	690.50	Brushed Nickel	3	
		UTS344301BG	690.50	Brushed Gold	3	
		UTS344301BL	759.50	Matte Black	3	
	M-CORE® MIXING SHOWER VALVE					
 <ul style="list-style-type: none"> • tub/shower or shower only application • ports: four with adj. temp. limit stops • included: test plug and cross flow plug 		U140CI	71.20	1/2" CC/IPS	6	
		U140X	71.20	1/2" Crimp Ring PEX + CC/IPS Tub	6	
		U140CX	71.20	1/2" Cold Exp. PEX + CC/IPS Tub	6	
		U140V	87.20	1/2" CPVC + CC/IPS Tub	6	
	 <ul style="list-style-type: none"> • tub/shower or shower only application • ports: four with adj. temp. limit stops • quarter turn stops: included 		U140CIS	102.45	1/2" CC/IPS	6
		U140XS	102.45	1/2" Crimp Ring PEX + CC/IPS Tub	6	
		U140CXS	102.45	1/2" Cold Exp. PEX + CC/IPS Tub	6	
		U140VS	118.50	1/2" CPVC + CC/IPS Tub	6	
 <ul style="list-style-type: none"> • tub/shower only application • ports: four with adj. temp. limit stops • tub outlet: pre-fabricated 1/2" copper tube • included: quarter turn stops and plugs 			U140X-PF	80.40	1/2" Crimp Ring PEX	6
		U140CX-PF	80.40	1/2" Cold Exp. PEX	6	
 <ul style="list-style-type: none"> • tub/shower only application • ports: four with adj. temp. limit stops • tub outlet: pre-fabricated 1/2" copper tube • included: quarter turn stops and plugs 		U140XS-PF	111.70	1/2" Crimp Ring PEX	6	
		U140CXS-PF	111.70	1/2" Cold Exp. PEX	6	
 <ul style="list-style-type: none"> • shower only application • ports: three 		U130CI	71.20	1/2" CC/IPS	6	
		U130X	71.20	1/2" Crimp Ring PEX	6	
		U130CX	71.20	1/2" Cold Exp. PEX	6	
 <ul style="list-style-type: none"> • shower only application • ports: three • quarter turn stops: included 		U130CIS	102.45	1/2" CC/IPS	6	
		U130XS	102.45	1/2" Crimp Ring PEX	6	
		U130CXS	102.45	1/2" Cold Exp. PEX	6	
<p>Four port valves can be used with either Tub/Shower or Shower Only applications. Three port valves can ONLY be used with Shower Only applications. For more product details, reference pages 465-466 in valve section.</p>						
<p>HOW TO ORDER VALVES: PAGES 465-466</p>		 <p>TRIM PART #</p>	+	 <p>VALVE PART #</p>	=	 <p>COMPLETE FAUCET</p>















COLINET™ Collection

		MODEL	LIST	FINISH/CONNECT	CASE QTY		
M-CORE® 3-SERIES WITH INTEGRATED TRANSFER VALVE TRIM - PREMIUM							
 <ul style="list-style-type: none"> • includes: pressure balanced cartridge with volume and temperature control • valve: sold separately  		UTS9211	485.70	Chrome	4		
		UTS9211BN	704.30	Brushed Nickel	4		
		UTS9211BG	704.30	Brushed Gold	4		
		UTS9211BL	774.70	Matte Black	4		
M-CORE® WITH INTEGRATED TRANSFER VALVE							
Three Function (2 independent/1 shared) OR Six Function (3 independent/3 shared) - plumbing configuration page 472							
 <ul style="list-style-type: none"> • ports: four with adj. temp. limit stops • check stops: included 		U362CIS	265.40	1/2" CC/IPS	6		
		U362CXS	265.40	1/2" Cold Exp. PEX	6		
		U362XS	265.40	1/2" Crimp Ring PEX	6		
Two Independent Functions OR Three Independent Functions - plumbing configurations page 472							
 <ul style="list-style-type: none"> • ports: four with adj. temp. limit stops • check stops: included 		U232CIS	265.40	1/2" CC/IPS	6		
		U232CXS	265.40	1/2" Cold Exp. PEX	6		
		U232XS	265.40	1/2" Crimp Ring PEX	6		
For more product details, reference page 466 in valve section. See page 472 for plumbing configurations.							
HOW TO ORDER VALVES: PAGE 466		TRIM PART #	+		=		COMPLETE FAUCET

M-CORE® TRANSFER VALVE TRIM - PREMIUM							
 <ul style="list-style-type: none"> • use with the M-CORE® transfer valve • valve: sold separately  		UTS9381	315.90	Chrome	12		
		UTS9381BN	428.85	Brushed Nickel	12		
		UTS9381BG	428.85	Brushed Gold	12		
		UTS9381BL	471.75	Matte Black	12		
M-CORE® TRANSFER VALVE							
Three Function (2 independent/1 shared) OR Six Function (3 independent/3 shared) - plumbing configuration page 472							
 <ul style="list-style-type: none"> • number of functions: three or six • ports: four 		U361CI	149.70	1/2" CC/IPS	6		
		U361CX	149.70	1/2" Cold Exp. PEX	6		
		U361X	149.70	1/2" Crimp Ring PEX	6		
Two Independent Functions OR Three Independent Functions - plumbing configurations page 472							
 <ul style="list-style-type: none"> • number of functions: two or three • ports: four 		U231CI	149.70	1/2" CC/IPS	6		
		U231CX	149.70	1/2" Cold Exp. PEX	6		
		U231X	149.70	1/2" Crimp Ring PEX	6		
For more product details, reference page 466 in valve section. See page 472 for plumbing configurations.							
HOW TO ORDER VALVES: PAGE 466		TRIM PART #	+		=		COMPLETE FAUCET

		MODEL	LIST	FINISH/CONNECT	CASE QTY
M-CORE® 2-SERIES TUB/SHOWER TRIM - PREMIUM					
 <ul style="list-style-type: none"> • showerhead: single-function eco-performance rainshower • showerhead size: 10" diameter • tub spout length: 9" • tub spout connection type: slip fit • tub spout type: diverter • includes: pressure balanced cartridge with temperature control • valve: sold separately 			1.75 GPM (6.65 L/min) max.		
		UTS244203EP	679.05	Chrome	3
		UTS244203EPBN	943.10	Brushed Nickel	3
		UTS244203EPBG	943.10	Brushed Gold	3
		UTS244203EPBL	1022.30	Matte Black	3
					
M-CORE® 2-SERIES SHOWER ONLY TRIM - PREMIUM					
 <ul style="list-style-type: none"> • showerhead: single-function eco-performance rainshower • showerhead size: 10" diameter • includes: pressure balanced cartridge with temperature control • valve: sold separately 			1.75 GPM (6.65 L/min) max.		
		UTS244202EP	566.30	Chrome	3
		UTS244202EPBN	773.90	Brushed Nickel	3
		UTS244202EPBG	773.90	Brushed Gold	3
		UTS244202EPBL	836.15	Matte Black	3
					
M-CORE® 2-SERIES VALVE ONLY TRIM - PREMIUM					
 <ul style="list-style-type: none"> • includes: pressure balanced cartridge with temperature control • valve: sold separately 		UTS244201	425.35	Chrome	3
		UTS244201BN	562.60	Brushed Nickel	3
		UTS244201BG	562.60	Brushed Gold	3
		UTS244201BL	603.75	Matte Black	3
M-CORE® MIXING SHOWER VALVE					
 <ul style="list-style-type: none"> • tub/shower or shower only application • ports: four with adj. temp. limit stops • included: test plug and cross flow plug 		U140CI	71.20	1/2" CC/IPS	6
		U140X	71.20	1/2" Crimp Ring PEX + CC/IPS Tub	6
		U140CX	71.20	1/2" Cold Exp. PEX + CC/IPS Tub	6
		U140V	87.20	1/2" CPVC + CC/IPS Tub	6
 <ul style="list-style-type: none"> • tub/shower or shower only application • ports: four with adj. temp. limit stops • quarter turn stops: included 		U140CIS	102.45	1/2" CC/IPS	6
		U140XS	102.45	1/2" Crimp Ring PEX + CC/IPS Tub	6
		U140CXS	102.45	1/2" Cold Exp. PEX + CC/IPS Tub	6
		U140VS	118.50	1/2" CPVC + CC/IPS Tub	6
 <ul style="list-style-type: none"> • tub/shower only application • ports: four with adj. temp. limit stops • tub outlet: pre-fabricated 1/2" copper tube • included: quarter turn stops and plugs 		U140X-PF	80.40	1/2" Crimp Ring PEX	6
		U140CX-PF	80.40	1/2" Cold Exp. PEX	6
					
 <ul style="list-style-type: none"> • tub/shower only application • ports: four with adj. temp. limit stops • tub outlet: pre-fabricated 1/2" copper tube • included: quarter turn stops and plugs 		U140XS-PF	111.70	1/2" Crimp Ring PEX	6
		U140CXS-PF	111.70	1/2" Cold Exp. PEX	6
					
 <ul style="list-style-type: none"> • shower only application • ports: three 		U130CI	71.20	1/2" CC/IPS	6
		U130X	71.20	1/2" Crimp Ring PEX	6
		U130CX	71.20	1/2" Cold Exp. PEX	6
					
 <ul style="list-style-type: none"> • shower only application • ports: three • quarter turn stops: included 		U130CIS	102.45	1/2" CC/IPS	6
		U130XS	102.45	1/2" Crimp Ring PEX	6
		U130CXS	102.45	1/2" Cold Exp. PEX	6
					
<p>Four port valves can be used with either Tub/Shower or Shower Only applications. Three port valves can ONLY be used with Shower Only applications. For more product details, reference pages 465-466 in valve section.</p>					
<p>HOW TO ORDER VALVES: PAGES 465-466</p>					

COLINET™ Collection

		MODEL	LIST	FINISH/CONNECT	CASE QTY	
POSI-TEMP® VALVE ONLY TRIM - PREMIUM						
 <ul style="list-style-type: none"> • valve: sold separately 	 	TS44201	274.35	Chrome	3	
		TS44201BN	411.60	Brushed Nickel	3	
		TS44201BG	411.60	Brushed Gold	3	
		TS44201BL	452.75	Matte Black	3	
POSI-TEMP® SHOWER MIXING VALVES						
 <ul style="list-style-type: none"> • tub/shower or shower only application • ports: four with adjustable temp. limit stops • test plug: included 		2520 ◆	156.10	1/2" CC	6	
		2510 ◆	156.10	1/2" IPS	6	
 <ul style="list-style-type: none"> • tub/shower or shower only application • ports: four with adjustable temp. limit stops • quarter turn stops: included • test plug: included 		2570 ◆	189.55	1/2" CC	6	
		2590 ◆	189.55	1/2" IPS	6	
		2580 ◆	156.10	1/2" Crimp ring PEX	6	
 <ul style="list-style-type: none"> • tub/shower only application • ports: four with adjustable temp. limit stops • quarter turn stops: included • test plug: included 		2360PF	208.45	1/2" Crimp Ring PEX	3	
		2385PF	208.45	1/2" Cold Exp. PEX	3	
 <ul style="list-style-type: none"> • shower only application • ports: three with adjustable temp. limit stops • quarter turn stops: included • test plug: included 		2326PF	201.20	1/2" Crimp Ring PEX	6	
		2328PF	201.20	1/2" Cold Exp. PEX	6	
Four port valves can be used with either Tub/Shower or Shower Only applications. Three port valves can ONLY be used with Shower Only applications. For more product details, reference page 467-468 in valve section.						
HOW TO ORDER VALVES: PAGES 467-470		 TRIM PART #	+	 VALVE PART #	=	 COMPLETE FAUCET

Moen® bath accessories CANNOT be combined with Moen faucet parts on a Purchase Order.

A PERFECT MATCH

A line of perfectly matching accessories - including tank levers and towel bars - allow for a completely cohesive look in the bath.

MODEL NUMBER	LIST EACH	DESCRIPTION	QTY
PREMIUM			
Chrome (CH)			
YB0501CH	90.65	Tank Lever	24
YB0503CH	69.50	Double Robe Hook	24
YB0505CH	18.25	Drawer Knob	48
YB0507CH	36.65	Drawer Pull	48
Ⓟ YB0508CH	127.80	Pivoting Paper Holder	6
YB0518CH	147.05	18" Towel Bar	6
YB0524CH	152.25	24" Towel Bar	6
YB0586CH	102.70	Towel Ring	6
Brushed Nickel (BN)			
YB0501BN	117.85	Tank Lever	9
YB0503BN	90.35	Double Robe Hook	24
YB0505BN	23.75	Drawer Knob	48
YB0507BN	47.70	Drawer Pull	48
Ⓟ YB0508BN	166.15	Pivoting Paper Holder	6
YB0518BN	191.15	18" Towel Bar	6
YB0524BN	197.90	24" Towel Bar	6
YB0586BN	133.60	Towel Ring	6
Matte Black (BL)			
YB0501BL	129.65	Tank Lever	24
YB0503BL	99.40	Double Robe Hook	24
YB0505BL	26.20	Drawer Knob	48
YB0507BL	52.40	Drawer Pull	48
Ⓟ YB0508BL	182.85	Pivoting Paper Holder	6
YB0518BL	210.30	18" Towel Bar	6
YB0524BL	217.65	24" Towel Bar	6
YB0586BL	146.95	Towel Ring	6
Brushed Gold (BG)			
YB0501BG	136.05	Tank Lever	24
YB0503BG	104.20	Double Robe Hook	24
YB0505BG	27.45	Drawer Knob	48
YB0507BG	55.05	Drawer Pull	48
Ⓟ YB0508BG	191.75	Pivoting Paper Holder	6
YB0518BG	220.55	18" Towel Bar	6
YB0524BG	228.35	24" Towel Bar	6
YB0586BG	154.10	Towel Ring	6

Ⓟ Denotes pivoting paper holder



Tank Lever
YB0501



Double Robe Hook
YB0503



Towel Ring
YB0586



Pivoting Paper Holder
YB0508 | Ⓟ



Drawer Knob
YB0505



18" Towel Bar
YB0518



Drawer Pull
YB0507

24" Towel Bar
YB0524



LIGHTING

MODEL NUMBER	LIST EACH	DESCRIPTION	QTY
PREMIUM			
Chrome (CH)			
YB0561CH	232.90	One Globe Bath Light	2
YB0562CH	325.90	Two Globe Bath Light	2
YB0563CH	404.70	Three Globe Bath Light	2
YB0564CH	505.80	Four Globe Bath Light	2
Brushed Nickel (BN)			
YB0561BN	302.70	One Globe Bath Light	2
YB0562BN	423.65	Two Globe Bath Light	2
YB0563BN	526.05	Three Globe Bath Light	2
YB0564BN	657.55	Four Globe Bath Light	2
Matte Black (BL)			
YB0561BL	333.00	One Globe Bath Light	2
YB0562BL	466.00	Two Globe Bath Light	2
YB0563BL	578.65	Three Globe Bath Light	2
YB0564BL	723.30	Four Globe Bath Light	2
Brushed Gold (BG)			
YB0561BG	349.35	One Globe Bath Light	2
YB0562BG	488.90	Two Globe Bath Light	2
YB0563BG	607.00	Three Globe Bath Light	2
YB0564BG	758.75	Four Globe Bath Light	2
Replacement Globe			
YB0569	41.95	Replacement Globe	3

COLINET™



One Globe Bath Light

YB0561



Two Globe Bath Light

YB0562



Three Globe Bath Light

YB0563



Four Globe Bath Light

YB0564



Replacement Globe

YB0569

















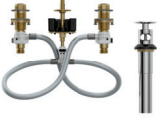













Bulbs not included.





List price is per each (unless otherwise noted).















Product can be ordered by case quantity or individually.









One, Three and Four Colinet lighting fixtures can be mounted facing either upward or downward
Two Globe lighting can be mounted facing either vertically or horizontally without the need to remove the rings.









	MODEL	LIST	FINISH/CONNECT	CASE QTY	
ONE-HANDLE BATHROOM FAUCET - PREMIUM					
 DECKPLATE SOLD SEPARATELY 	<ul style="list-style-type: none"> • application: one or three hole • supply lines: flexible • connection: 3/8" compression • deckplate: sold separately • drain assembly: metal with lift rod 	<p>1.2 GPM (4.5L/min) max.</p> <p>S6710 604.20 Chrome 3</p> <p>S6710BN 906.30 Brushed Nickel 3</p> <p>Q3 NEW! S6710BL 936.50 Matte Black 3</p>			
	<p>♿ DURALAST®</p> <p>OPTIONAL DECKPLATE SOLD SEPARATELY</p> <p>147204 30.45 Chrome 12</p> <p>147204BN 73.75 Brushed Nickel 12</p> <p>147204BL 81.10 Matte Black 12</p>				
 DECKPLATE SOLD SEPARATELY 	<ul style="list-style-type: none"> • application: one or three hole • supply lines: flexible • connection: 3/8" compression • deckplate: sold separately • drain assembly: 140780 sold separately 	<p>1.2 GPM (4.5L/min) max.</p> <p>S6712 845.70 Chrome 3</p> <p>S6712BN 1099.40 Brushed Nickel 3</p> <p>Q3 NEW! S6712BL 1141.65 Matte Black 3</p>			
	<p>♿ DURALAST®</p> <p>OPTIONAL DECKPLATE SOLD SEPARATELY</p> <p>147204 30.45 Chrome 12</p> <p>147204BN 73.75 Brushed Nickel 12</p> <p>147204BL 81.10 Matte Black 12</p>				
OPTION: VESSEL EXTENSION KIT					
 <ul style="list-style-type: none"> • description: vessel extension kit • included: parts to convert to grid drain • included: two extensions • fits S6710 	<p>147556 160.15 Chrome 6</p> <p>147556BN 234.85 Brushed Nickel 6</p> <p>147556BL 258.35 Matte Black 6</p>				
TWO-HANDLE WIDESPREAD BATHROOM FAUCET TRIM - PREMIUM					
 <ul style="list-style-type: none"> • application: three hole • center dimensions: 8" - 16" center • drain assembly: metal with lift rod • red/blue markings: included • valve: sold separately 	<p>1.2 GPM (4.5L/min) max.</p> <p>TS6721 540.90 Chrome 3</p> <p>TS6721BN 811.35 Brushed Nickel 3</p> <p>Q3 NEW! TS6721BL 838.40 Matte Black 3</p>				
	<p>♿</p> <p>♻️</p>				
WIDESPREAD FAUCET VALVE					
 <ul style="list-style-type: none"> • application: three hole • center dimensions: 8" - 16" center • drain assembly: metal with lift rod 	<p>9000♦ 162.15 1/2" IPS 6</p>				
<p>♻️ DURALOCK® DURALAST®</p>					
<p>HOW TO ORDER VALVES: PAGE 463</p>	 TRIM PART #	+	 VALVE PART #	=	 COMPLETE FAUCET

















		MODEL	LIST	FINISH/CONNECT	CASE QTY
TWO-HANDLE WALLMOUNT BATHROOM FAUCET TRIM - PREMIUM					
 <ul style="list-style-type: none"> • application: three hole • center dimensions: 8" center • drain assembly: 140780 sold separately • valve: sold separately 			1.2 GPM (4.5L/min) max.		
		TS6731	627.35	Chrome	3
		TS6731BN	846.90	Brushed Nickel	3
	Q3 	TS6731BL	878.30	Matte Black	3
TWO-HANDLE WALLMOUNT FAUCET VALVE					
 <ul style="list-style-type: none"> • application: three hole • center dimensions: 8" center • drain assembly: 140780 sold separately • includes: mounting brackets  DURALAST®		9700	229.35	1/2" CC	3
	HOW TO ORDER VALVES: PAGE 463  TRIM PART # +  VALVE PART # =  COMPLETE FAUCET				
OPTION: DRAIN ASSEMBLY					
 <ul style="list-style-type: none"> • drain assembly: metal • drain assembly type: spring loaded pop-up • drain assembly size: 1-1/4" • drain assembly: 1-1/4" non-overflow 		140780	76.80	Chrome	12
		140780BN	107.05	Brushed Nickel	12
		140780BL	120.90	Matte Black	12
	HOW TO ORDER VALVES: PAGE 463				
FREESTANDING TUB FILLER TRIM - PREMIUM					
 <ul style="list-style-type: none"> • application: one hole • showerhead type: handshower • handshower functions: one-function • handshower flow rate: 1.75 gpm (6.65L/min) max. • spout reach: 11.00" • mounting kit: sold separately 		S905	2246.60	Chrome	1
		S905BN	3032.85	Brushed Nickel	1
	Q3 	S905BL	3032.90	Matte Black	1
	HOW TO ORDER VALVES: PAGE 463				
FREESTANDING TUB FILLER VALVE AND MOUNTING KIT - PREMIUM					
 <ul style="list-style-type: none"> • description: single riser floor joist mounting kit • application: one hole • quarter turn stops: included 		TS50100	400.90	1/2" CC, NPT	2
	 <ul style="list-style-type: none"> • description: single riser concrete mounting kit • application: one hole • connection size: 1/2" 		TS50110	325.95	1/2" CC, NPT
HOW TO ORDER VALVES: PAGE 463  TRIM PART # +  VALVE PART # =  COMPLETE FAUCET					

























	MODEL	LIST	FINISH/CONNECT	CASE QTY
ONE-HANDLE WALLMOUNT TUB FILLER TRIM - PREMIUM				
 <ul style="list-style-type: none"> • application: two hole • connection: 1/2" slip fit • tub spout type: non diverter • spout reach: 10.00" • includes: high flow volume control cartridge • WMV130 series valve kit: sold separately 	WTS911	790.25	Chrome	3
	WTS911BN	1114.25	Brushed Nickel	3
	Q3 NEW! WTS911BL	1145.85	Matte Black	3
ONE-HANDLE WALLMOUNT TUB FILLER VALVE KIT				
 <ul style="list-style-type: none"> • application: two hole with adj. center dimensions • ports: three • quarter turn stops: included • includes: test plug • includes: spout manifold 	WMV130CIS	151.05	1/2" CC/IPS	6
	WMV130XS	151.05	1/2" Crimp Ring PEX	6
	WMV130CXS	151.05	1/2" Cold Exp. PEX	6
HOW TO ORDER VALVES: PAGE 463  TRIM PART # +  VALVE PART # =  COMPLETE FAUCET				











TWO-HANDLE ROMAN TUB TRIM - PREMIUM				
 <ul style="list-style-type: none"> • application: three hole • spout reach: 8.20" • valve: sold separately 	TS913	741.90	Chrome	3
	TS913BN	1038.65	Brushed Nickel	3
	Q3 NEW! TS913BL	1075.75	Matte Black	3
TWO-HANDLE ROMAN TUB TRIM WITH HANDSHOWER - PREMIUM				
 <ul style="list-style-type: none"> • application: four hole • showerhead type: handshower • handshower flow rate: 1.75 gpm (6.65 L/min) max. • spray functions: one-function • spout reach: 8.20" • valve: sold separately 	TS914	1155.50	Chrome	3
	TS914BN	1938.75	Brushed Nickel	3
	Q3 NEW! TS914BL	1964.35	Matte Black	3
TWO-HANDLE ROMAN TUB VALVE				
 <ul style="list-style-type: none"> • deck thickness: 1/8" to 3-3/8" rough-in deck • adjustable spout shank: adjustable center dimensions 	4792	188.55	1/2" CC	6
	 DURALAST®			
 <ul style="list-style-type: none"> • deck thickness: 1/8" to 2-3/4" rough-in deck • adjustable spout shank: 10" - 24" center dimensions 	4793	213.55	1/2" CPVC, Crimp Ring PEX	6
	4794	203.60	1/2" Crimp Ring PEX, Cold Exp. PEX	6
	 DURALOCK® DURALAST®			
 <ul style="list-style-type: none"> • deck thickness: 1/8" to 3-3/16" rough-in deck • Non-adjustable spout shank: 10" center dimensions 	4796	177.65	1/2" CC	6
	4797	181.10	1/2" CPVC, Crimp Ring PEX	6
	4798	181.10	1/2" Crimp Ring PEX, Cold Exp. PEX	6
TWO-HANDLE ROMAN TUB VALVE WITH HANDSHOWER				
 <ul style="list-style-type: none"> • deck thickness: 1/8" to 2-5/8" rough-in deck • non-adj spout shank: adjustable center dim's 	9792	424.85	1/2" CC	6
	 DURALAST®			
 <ul style="list-style-type: none"> • deck thickness: 1/8" to 2-5/8" rough-in deck • adj spout shank: 10" - 24" center dimensions 	9793	434.80	1/2" CPVC, Crimp Ring PEX	6
	 DURALOCK® DURALAST®			
For more product details, reference page 464 in valve section.				
HOW TO ORDER VALVES: PAGE 464  TRIM PART # +  VALVE PART # =  COMPLETE FAUCET				











		MODEL	LIST	FINISH/CONNECT	CASE QTY			
EXACTTEMP® VALVE ONLY TRIM - PREMIUM								
 <ul style="list-style-type: none"> • description: temperature control valve trim • requires: separate volume control valve • valve: sold separately  		TS3100	398.25	Chrome	3			
		TS3100BN	602.40	Brushed Nickel	3			
	Q3 	TS3100BL	617.25	Matte Black	3			
EXACTTEMP® THERMOSTATIC MIXING SHOWER VALVE - PREMIUM								
 <ul style="list-style-type: none"> • description: thermostatic rough-in valve • ports: four with adjustable temp. limit stops • check stops: included 		S3371	714.65	3/4" IPS	6			
HOW TO ORDER								
VALVES: PAGE 465		TRIM PART #	+		VALVE PART #	=		COMPLETE FAUCET



















EXACTTEMP® VOLUME CONTROL VALVE TRIM - PREMIUM								
 <ul style="list-style-type: none"> • valve: sold separately  		TS3300	183.85	Chrome	6			
		TS3300BN	245.15	Brushed Nickel	6			
	Q3 	TS3300BL	248.15	Matte Black	6			
EXACTTEMP® VOLUME CONTROL SHOWER VALVE - PREMIUM								
 <ul style="list-style-type: none"> • includes: volume control 		S3600	181.70	3/4" IPS	12			
HOW TO ORDER								
VALVES: PAGE 465		TRIM PART #	+		VALVE PART #	=		COMPLETE FAUCET















		MODEL	LIST	FINISH/CONNECT	CASE QTY
M-CORE® 4-SERIES TUB/SHOWER TRIM - PREMIUM					
 <ul style="list-style-type: none"> • showerhead: single-function eco-performance rainshower • showerhead size: 6" diameter • tub spout length: 7 1/4" • tub spout connection type: slip fit • tub spout type: diverter • includes: thermostatic cartridge with volume and temperature control • valve: sold separately 			1.75 GPM (6.65 L/min) max.		
	Q2 NEW!	UTS4713EP	776.40	Chrome	4
	Q2 NEW!	UTS4713EPBN	1364.30	Brushed Nickel	4
	Q3 NEW!	UTS4713EPBL	1385.75	Matte Black	4
					
M-CORE® 4-SERIES SHOWER ONLY TRIM - PREMIUM					
 <ul style="list-style-type: none"> • showerhead: single-function eco-performance rainshower • showerhead size: 6" diameter • includes: thermostatic cartridge with volume and temperature control • valve: sold separately 			1.75 GPM (6.65 L/min) max.		
	Q2 NEW!	UTS4715EP	655.10	Chrome	4
	Q2 NEW!	UTS4715EPBN	1137.00	Brushed Nickel	4
	Q3 NEW!	UTS4715EPBL	1149.20	Matte Black	4
					
M-CORE® 4-SERIES VALVE ONLY TRIM - PREMIUM					
 <ul style="list-style-type: none"> • includes: thermostatic cartridge with volume and temperature control • valve: sold separately 	Q2 NEW!	UTS4711	570.20	Chrome	3
	Q2 NEW!	UTS4711BN	949.30	Brushed Nickel	3
	Q3 NEW!	UTS4711BL	961.85	Matte Black	3
					
M-CORE® MIXING SHOWER VALVE					
 <ul style="list-style-type: none"> • tub/shower or shower only application • ports: four with adj. temp. limit stops • included: test plug and cross flow plug 		U140CI	71.20	1/2" CC/IPS	6
		U140X	71.20	1/2" Crimp Ring PEX + CC/IPS Tub	6
		U140CX	71.20	1/2" Cold Exp. PEX + CC/IPS Tub	6
		U140V	87.20	1/2" CPVC + CC/IPS Tub	6
 <ul style="list-style-type: none"> • tub/shower or shower only application • ports: four with adj. temp. limit stops • quarter turn stops: included 		U140CIS	102.45	1/2" CC/IPS	6
		U140XS	102.45	1/2" Crimp Ring PEX + CC/IPS Tub	6
		U140CXS	102.45	1/2" Cold Exp. PEX + CC/IPS Tub	6
		U140VS	118.50	1/2" CPVC + CC/IPS Tub	6
 <ul style="list-style-type: none"> • tub/shower only application • ports: four with adj. temp. limit stops • tub outlet: pre-fabricated 1/2" copper tube • included: quarter turn stops and plugs 		U140X-PF	80.40	1/2" Crimp Ring PEX	6
		U140CX-PF	80.40	1/2" Cold Exp. PEX	6
 <ul style="list-style-type: none"> • tub/shower only application • ports: four with adj. temp. limit stops • tub outlet: pre-fabricated 1/2" copper tube • included: quarter turn stops and plugs 		U140XS-PF	111.70	1/2" Crimp Ring PEX	6
		U140CXS-PF	111.70	1/2" Cold Exp. PEX	6
 <ul style="list-style-type: none"> • shower only application • ports: three 		U130CI	71.20	1/2" CC/IPS	6
		U130X	71.20	1/2" Crimp Ring PEX	6
		U130CX	71.20	1/2" Cold Exp. PEX	6
 <ul style="list-style-type: none"> • shower only application • ports: three • quarter turn stops: included 		U130CIS	102.45	1/2" CC/IPS	6
		U130XS	102.45	1/2" Crimp Ring PEX	6
		U130CXS	102.45	1/2" Cold Exp. PEX	6
<p>Four port valves can be used with either Tub/Shower or Shower Only applications. Three port valves can ONLY be used with Shower Only applications. For more product details, reference pages 465-466 in valve section.</p>					
<p>HOW TO ORDER VALVES: PAGES 465-466</p>		 TRIM PART #   VALVE PART #   COMPLETE FAUCET			















		MODEL	LIST	FINISH/CONNECT	CASE QTY	
M-CORE® 3-SERIES TUB/SHOWER TRIM - PREMIUM						
 <ul style="list-style-type: none"> • showerhead: single-function rainshower • showerhead size: 6" diameter • tub spout length: 7 1/4" • tub spout connection type: slip fit • tub spout type: diverter • includes: pressure balanced cartridge with volume and temperature control • valve: sold separately <p>  IMMERSON</p>		2.5 GPM (9.5 L/min) max.				
		UTS3713	641.40	Chrome	4	
		UTS3713BN	1229.30	Brushed Nickel	4	
	Q3 NEW!	UTS3713BL	1250.75	Matte Black	4	
		1.75 GPM (6.65 L/min) max.				
		UTS3713EP	641.40	Chrome	4	
		UTS3713EPBN	1229.30	Brushed Nickel	4	
	Q3 NEW!	UTS3713EPBL	1250.75	Matte Black	4	
	M-CORE® 3-SERIES SHOWER ONLY TRIM - PREMIUM					
	 <ul style="list-style-type: none"> • showerhead: single-function rainshower • showerhead size: 6" diameter • includes: pressure balanced cartridge with volume and temperature control • valve: sold separately <p>  IMMERSON</p>		2.5 GPM (9.5 L/min) max.			
		UTS3715	520.10	Chrome	4	
		UTS3715BN	1002.00	Brushed Nickel	4	
Q3 NEW!		UTS3715BL	1014.20	Matte Black	4	
		1.75 GPM (6.65 L/min) max.				
		UTS3715EP	520.10	Chrome	4	
		UTS3715EPBN	1002.00	Brushed Nickel	4	
Q3 NEW!		UTS3715EPBL	1014.20	Matte Black	4	
M-CORE® 3-SERIES VALVE ONLY TRIM - PREMIUM						
 <ul style="list-style-type: none"> • includes: pressure balanced cartridge with volume and temperature control • valve: sold separately <p> </p>			UTS3711	435.20	Chrome	3
		UTS3711BN	814.30	Brushed Nickel	3	
	Q3 NEW!	UTS3711BL	826.85	Matte Black	3	
	M-CORE® MIXING SHOWER VALVE					
 <ul style="list-style-type: none"> • tub/shower or shower only application • ports: four with adj. temp. limit stops • included: test plug and cross flow plug <p></p>		U140CI	71.20	1/2" CC/IPS	6	
		U140X	71.20	1/2" Crimp Ring PEX + CC/IPS Tub	6	
		U140CX	71.20	1/2" Cold Exp. PEX + CC/IPS Tub	6	
		U140V	87.20	1/2" CPVC + CC/IPS Tub	6	
 <ul style="list-style-type: none"> • tub/shower or shower only application • ports: four with adj. temp. limit stops • quarter turn stops: included <p></p>		U140CIS	102.45	1/2" CC/IPS	6	
		U140XS	102.45	1/2" Crimp Ring PEX + CC/IPS Tub	6	
		U140CXS	102.45	1/2" Cold Exp. PEX + CC/IPS Tub	6	
		U140VS	118.50	1/2" CPVC + CC/IPS Tub	6	
 <ul style="list-style-type: none"> • tub/shower only application • ports: four with adj. temp. limit stops • tub outlet: pre-fabricated 1/2" copper tube • included: quarter turn stops and plugs <p></p>		U140X-PF	80.40	1/2" Crimp Ring PEX	6	
		U140CX-PF	80.40	1/2" Cold Exp. PEX	6	
 <ul style="list-style-type: none"> • tub/shower only application • ports: four with adj. temp. limit stops • tub outlet: pre-fabricated 1/2" copper tube • included: quarter turn stops and plugs <p></p>		U140XS-PF	111.70	1/2" Crimp Ring PEX	6	
		U140CXS-PF	111.70	1/2" Cold Exp. PEX	6	
 <ul style="list-style-type: none"> • shower only application • ports: three <p></p>		U130CI	71.20	1/2" CC/IPS	6	
		U130X	71.20	1/2" Crimp Ring PEX	6	
		U130CX	71.20	1/2" Cold Exp. PEX	6	
 <ul style="list-style-type: none"> • shower only application • ports: three • quarter turn stops: included <p></p>		U130CIS	102.45	1/2" CC/IPS	6	
		U130XS	102.45	1/2" Crimp Ring PEX	6	
		U130CXS	102.45	1/2" Cold Exp. PEX	6	
<p>Four port valves can be used with either Tub/Shower or Shower Only applications. Three port valves can ONLY be used with Shower Only applications. For more product details, reference pages 465-466 in valve section.</p>						
<p>HOW TO ORDER VALVES: PAGES 465-466</p>		 <p>TRIM PART #</p>	+	 <p>VALVE PART #</p>	=	 <p>COMPLETE FAUCET</p>

		MODEL	LIST	FINISH/CONNECT	CASE QTY			
M-CORE[®] 3-SERIES WITH INTEGRATED TRANSFER VALVE TRIM - PREMIUM								
 <ul style="list-style-type: none"> • includes: pressure balanced cartridge with volume and temperature control • valve: sold separately  		UTS9011	420.40	Chrome	4			
		UTS9011BN	608.70	Brushed Nickel	4			
		 UTS9011BL	630.60	Matte Black	4			
M-CORE[®] WITH INTEGRATED TRANSFER VALVE								
Three Function (2 independent/1 shared) OR Six Function (3 independent/3 shared) - plumbing configuration page 472								
 <ul style="list-style-type: none"> • ports: four with adj. temp. limit stops • check stops: included 		U362CIS	265.40	1/2" CC/IPS	6			
		U362CXS	265.40	1/2" Cold Exp. PEX	6			
		U362XS	265.40	1/2" Crimp Ring PEX	6			
Two Independent Functions OR Three Independent Functions - plumbing configurations page 472								
 <ul style="list-style-type: none"> • ports: four with adj. temp. limit stops • check stops: included 		U232CIS	265.40	1/2" CC/IPS	6			
		U232CXS	265.40	1/2" Cold Exp. PEX	6			
		U232XS	265.40	1/2" Crimp Ring PEX	6			
For more product details, reference page 466 in valve section. See page 472 for plumbing configurations.								
HOW TO ORDER VALVES: PAGE 466		TRIM PART #	+		VALVE PART #	=		COMPLETE FAUCET

M-CORE[®] TRANSFER VALVE TRIM - PREMIUM								
 <ul style="list-style-type: none"> • use with the M-CORE[®] transfer valve • valve: sold separately  		UTS4172	297.50	Chrome	12			
		UTS4172BN	370.40	Brushed Nickel	12			
		 UTS4172BL	386.75	Matte Black	12			
M-CORE[®] TRANSFER VALVE								
Three Function (2 independent/1 shared) OR Six Function (3 independent/3 shared) - plumbing configuration page 472								
 <ul style="list-style-type: none"> • number of functions: three or six • ports: four 		U361CI	149.70	1/2" CC/IPS	6			
		U361CX	149.70	1/2" Cold Exp. PEX	6			
		U361X	149.70	1/2" Crimp Ring PEX	6			
Two Independent Functions OR Three Independent Functions - plumbing configurations page 472								
 <ul style="list-style-type: none"> • number of functions: two or three • ports: four 		U231CI	149.70	1/2" CC/IPS	6			
		U231CX	149.70	1/2" Cold Exp. PEX	6			
		U231X	149.70	1/2" Crimp Ring PEX	6			
For more product details, reference page 466 in valve section. See page 472 for plumbing configurations.								
HOW TO ORDER VALVES: PAGE 466		TRIM PART #	+		VALVE PART #	=		COMPLETE FAUCET

		MODEL	LIST	FINISH/CONNECT	CASE QTY
M-CORE® 2-SERIES TUB/SHOWER TRIM - PREMIUM					
 <ul style="list-style-type: none"> • showerhead: single-function eco-performance rainshower • showerhead size: 6" diameter • tub spout length: 7 1/4" • tub spout connection type: slip fit • tub spout type: diverter • includes: pressure balanced cartridge with temperature control • valve: sold separately 	<ul style="list-style-type: none"> • 1.75 GPM (6.65 L/min) max. 	UTS2713EP	544.55	Chrome	4
		UTS2713EPBN	886.15	Brushed Nickel	4
		Q3 NEW! UTS2713EPBL	898.55	Matte Black	4
					
M-CORE® 2-SERIES SHOWER ONLY TRIM - PREMIUM					
 <ul style="list-style-type: none"> • showerhead: single-function eco-performance rainshower • showerhead size: 6" diameter • includes: pressure balanced cartridge with temperature control • valve: sold separately 	<ul style="list-style-type: none"> • 1.75 GPM (6.65 L/min) max. 	UTS2712EP	459.05	Chrome	4
		UTS2712EPBN	727.70	Brushed Nickel	4
		Q3 NEW! UTS2712EPBL	757.45	Matte Black	4
					
M-CORE® 2-SERIES VALVE ONLY TRIM - PREMIUM					
 <ul style="list-style-type: none"> • includes: pressure balanced cartridge with temperature control • valve: sold separately 	<ul style="list-style-type: none"> • 1.75 GPM (6.65 L/min) max. 	UTS2711	380.15	Chrome	3
		UTS2711BN	581.40	Brushed Nickel	3
		Q3 NEW! UTS2711BL	589.20	Matte Black	3
					
M-CORE® MIXING SHOWER VALVE					
 <ul style="list-style-type: none"> • tub/shower or shower only application • ports: four with adj. temp. limit stops • included: test plug and cross flow plug 		U140CI	71.20	1/2" CC/IPS	6
		U140X	71.20	1/2" Crimp Ring PEX + CC/IPS Tub	6
		U140CX	71.20	1/2" Cold Exp. PEX + CC/IPS Tub	6
		U140V	87.20	1/2" CPVC + CC/IPS Tub	6
 <ul style="list-style-type: none"> • tub/shower or shower only application • ports: four with adj. temp. limit stops • quarter turn stops: included 		U140CIS	102.45	1/2" CC/IPS	6
		U140XS	102.45	1/2" Crimp Ring PEX + CC/IPS Tub	6
		U140CXS	102.45	1/2" Cold Exp. PEX + CC/IPS Tub	6
		U140VS	118.50	1/2" CPVC + CC/IPS Tub	6
 <ul style="list-style-type: none"> • tub/shower only application • ports: four with adj. temp. limit stops • tub outlet: pre-fabricated 1/2" copper tube • included: quarter turn stops and plugs 		U140X-PF	80.40	1/2" Crimp Ring PEX	6
		U140CX-PF	80.40	1/2" Cold Exp. PEX	6
 <ul style="list-style-type: none"> • tub/shower only application • ports: four with adj. temp. limit stops • tub outlet: pre-fabricated 1/2" copper tube • included: quarter turn stops and plugs 		U140XS-PF	111.70	1/2" Crimp Ring PEX	6
		U140CXS-PF	111.70	1/2" Cold Exp. PEX	6
 <ul style="list-style-type: none"> • shower only application • ports: three 		U130CI	71.20	1/2" CC/IPS	6
		U130X	71.20	1/2" Crimp Ring PEX	6
		U130CX	71.20	1/2" Cold Exp. PEX	6
 <ul style="list-style-type: none"> • shower only application • ports: three • quarter turn stops: included 		U130CIS	102.45	1/2" CC/IPS	6
		U130XS	102.45	1/2" Crimp Ring PEX	6
		U130CXS	102.45	1/2" Cold Exp. PEX	6
<p>Four port valves can be used with either Tub/Shower or Shower Only applications. Three port valves can ONLY be used with Shower Only applications. For more product details, reference pages 465-466 in valve section.</p>					
<p>HOW TO ORDER VALVES: PAGES 465-466</p>					

		MODEL	LIST	FINISH/CONNECT	CASE QTY	
POSI-TEMP® TUB/SHOWER TRIM - PREMIUM						
 <ul style="list-style-type: none"> • showerhead: single-function rainshower • showerhead size: 6" diameter • tub spout length: 7 1/4" • tub spout connection type: slip fit • tub spout type: diverter • valve: sold separately 		2.5 GPM (9.5 L/min) max.				
		TS2713	400.70	Chrome	3	
		TS2713BN	742.35	Brushed Nickel	3	
	Q3 NEW!	TS2713BL	761.30	Matte Black	3	
		1.75 GPM (6.65 L/min) max.				
		TS2713EP	400.70	Chrome	3	
		TS2713EPBN	742.35	Brushed Nickel	3	
	Q3 NEW!	TS2713EPBL	761.30	Matte Black	3	
	POSI-TEMP® SHOWER ONLY TRIM - PREMIUM					
	 <ul style="list-style-type: none"> • showerhead: single-function rainshower • showerhead size: 6" diameter • valve: sold separately 		2.5 GPM (9.5 L/min) max.			
		TS2712	315.25	Chrome	3	
		TS2712BN	583.85	Brushed Nickel	3	
Q3 NEW!		TS2712BL	598.95	Matte Black	3	
		1.75 GPM (6.65 L/min) max.				
		TS2712EP	315.25	Chrome	3	
		TS2712EPBN	583.85	Brushed Nickel	3	
Q3 NEW!		TS2712EPBL	598.95	Matte Black	3	
POSI-TEMP® VALVE ONLY TRIM - PREMIUM						
 <ul style="list-style-type: none"> • valve: sold separately 			TS2711	236.30	Chrome	3
		TS2711BN	437.60	Brushed Nickel	3	
	Q3 NEW!	TS2711BL	449.00	Matte Black	3	
	POSI-TEMP® SHOWER MIXING VALVES					
 <ul style="list-style-type: none"> • tub/shower or shower only application • ports: four with adjustable temp. limit stops • test plug: included 		2520 ◆	156.10	1/2" CC	6	
		2510 ◆	156.10	1/2" IPS	6	
 <ul style="list-style-type: none"> • tub/shower or shower only application • ports: four with adjustable temp. limit stops • quarter turn stops: included • test plug: included 		2570 ◆	189.55	1/2" CC	6	
		2590 ◆	189.55	1/2" IPS	6	
		2580 ◆	156.10	1/2" Crimp ring PEX	6	
	 <ul style="list-style-type: none"> • tub/shower only application • ports: three with adjustable temp. limit stops • quarter turn stops: included • test plug: included 		2360PF	208.45	1/2" Crimp Ring PEX	3
		2385PF	208.45	1/2" Cold Exp. PEX	3	
 <ul style="list-style-type: none"> • shower only application • ports: three with adjustable temp. limit stops • quarter turn stops: included • test plug: included 		2326PF	201.20	1/2" Crimp Ring PEX	6	
		2328PF	201.20	1/2" Cold Exp. PEX	6	
<p>Four port valves can be used with either Tub/Shower or Shower Only applications. Three port valves can ONLY be used with Shower Only applications. For more product details, reference page 467-468 in valve section.</p>						
<p>HOW TO ORDER VALVES: PAGES 467-470</p>						

		MODEL	LIST	FINISH/CONNECT	CASE QTY
POSI-TEMP® WITH INTEGRATED TRANSFER VALVE TRIM - PREMIUM					
 <ul style="list-style-type: none"> • valve: sold separately  		TS2710	486.15	Chrome	4
		TS2710BN	900.05	Brushed Nickel	4
	Q3 	TS2710BL	923.65	Matte Black	4
POSI-TEMP® WITH INTEGRATED TRANSFER VALVE					
 <ul style="list-style-type: none"> • functions: three (two independent and one shared) • ports: four with adjustable temp. limit stops • test plug: included 		2551	281.85	1/2" IPS	6
 <ul style="list-style-type: none"> • functions: three (two independent and one shared) • ports: four with adjustable temp. limit stops • stops: included • test plug: included 		2581	317.40	1/2" IPS	6
 <ul style="list-style-type: none"> • functions: two independent • ports: four with adjustable temp. limit stops • test plug: included 		2521	281.85	1/2" IPS	6
 <ul style="list-style-type: none"> • functions: two independent • ports: four with adjustable temp. limit stops • stops: included • test plug: included 		2571	317.40	1/2" IPS	6
For more product details, reference page 471 in valve section.					
HOW TO ORDER VALVES: PAGE 471	 TRIM PART #	+	 VALVE PART #	=	 COMPLETE FAUCET

Moen[®] bath accessories CANNOT be combined with Moen faucet parts on a Purchase Order.

A PERFECT MATCH

A line of perfectly matching accessories - including tank levers and towel bars - allow for a completely cohesive look in the bath.

MODEL NUMBER	LIST EACH	DESCRIPTION	QTY
PREMIUM			
Chrome (CH)			
YB8801CH	83.10	Tank Lever	24
YB8803CH	63.65	Single Robe Hook	24
YB8805CH	16.80	Drawer Knob	48
YB8807CH	33.65	Drawer Pull	48
Ⓟ YB8808CH	117.15	Pivoting Paper Holder	6
YB8818CH	134.80	18" Towel Bar	6
YB8824CH	139.65	24" Towel Bar	6
YB8886CH	94.10	Hand Towel Bar	6
Brushed Nickel (BN)			
YB8801BN	89.70	Tank Lever	24
YB8803BN	68.90	Single Robe Hook	24
YB8805BN	19.40	Drawer Knob	48
YB8807BN	36.35	Drawer Pull	48
Ⓟ YB8808BN	126.40	Pivoting Paper Holder	6
YB8818BN	145.55	18" Towel Bar	6
YB8824BN	150.90	24" Towel Bar	6
YB8886BN	101.55	Hand Towel Bar	6

Matte Black (BL)			
YB8801BL	97.75	Tank Lever	24 NEW! Q3
YB8803BL	75.10	Single Robe Hook	24 NEW! Q3
YB8805BL	21.15	Drawer Knob	48 NEW! Q3
YB8807BL	39.60	Drawer Pull	48 NEW! Q3
Ⓟ YB8808BL	137.80	Pivoting Paper Holder	6 NEW! Q3
YB8818BL	158.65	18" Towel Bar	6 NEW! Q3
YB8824BL	164.45	24" Towel Bar	6 NEW! Q3
YB8886BL	110.70	Hand Towel Bar	6 NEW! Q3

Ⓟ Denotes pivoting paper holder

GRAB BARS

MODEL NUMBER	LIST EACH	DESCRIPTION	QTY
PREMIUM			
1 1/4" • Chrome (CH)			
YG8812CH	192.55	12" Designer Grab Bar	6
YG8818CH	201.20	18" Designer Grab Bar	6
YG8824CH	210.20	24" Designer Grab Bar	6
YG8836CH	239.25	36" Designer Grab Bar	6
YG8842CH	352.20	42" Designer Grab Bar	6
1 1/4" • Brushed Nickel (BN)			
YG8812BN	208.10	12" Designer Grab Bar	6
YG8818BN	218.10	18" Designer Grab Bar	6
YG8824BN	235.40	24" Designer Grab Bar	6
YG8836BN	265.05	36" Designer Grab Bar	6
YG8842BN	389.35	42" Designer Grab Bar	6
1 1/4" • Matte Black (BL)			
YG8812BL	226.85	12" Designer Grab Bar	6 NEW! Q3
YG8818BL	237.75	18" Designer Grab Bar	6 NEW! Q3
YG8824BL	256.55	24" Designer Grab Bar	6 NEW! Q3
YG8836BL	288.90	36" Designer Grab Bar	6 NEW! Q3
YG8842BL	424.40	42" Designer Grab Bar	6 NEW! Q3

Ⓟ Complies with Americans with Disabilities Act (ADA) specifications. SecureMount™ Grab Bars are tested to withstand 500 lb. pull when securely installed per instructions.



Tank Lever
YB8801



Single Robe Hook
YB8803



Pivoting Paper Holder
YB8808 | Ⓟ



Hand Towel Bar
YB8886



Drawer Knob
YB8805



18" Towel Bar
YB8818



Drawer Pull
YB8807

24" Towel Bar
YB8824

SECUREMOUNT

- SecureMount™ Grab Bars are manufactured with an innovative flange design that makes it easy to connect to the stud at multiple points.
- Tested to withstand 500lbs.
- To install grab bars securely without studs, use SecureMount™ Anchors. Sold separately.



18" Designer Grab Bar
YG8818

List price is per each (unless otherwise noted). Product can be ordered by case quantity or individually. For more information on ordering bath accessories, contact Moen Bath Accessory Customer Service at 800-882-0116, contact your local Moen sales representative, or visit us at www.moen.com.





LIGHTING

MODEL NUMBER	LIST EACH	DESCRIPTION	QTY
PREMIUM			
Chrome (CH)			
YB8861CH	213.45	One Globe Bath Light	2
YB8862CH	298.60	Two Globe Bath Light	2
YB8863CH	370.85	Three Globe Bath Light	2
YB8864CH	475.05	Four Globe Bath Light	2
Brushed Nickel (BN)			
YB8861BN	266.70	One Globe Bath Light	2
YB8862BN	373.35	Two Globe Bath Light	2
YB8863BN	463.85	Three Globe Bath Light	2
YB8864BN	593.75	Four Globe Bath Light	2
Matte Black (BL)			
YB8861BL	290.70	One Globe Bath Light	2 NEW! Q3
YB8862BL	406.95	Two Globe Bath Light	2 NEW! Q3
YB8863BL	505.60	Three Globe Bath Light	2 NEW! Q3
YB8864BL	647.15	Four Globe Bath Light	2 NEW! Q3

Replacement Globe

YB8869	39.20	Replacement Globe	3
--------	-------	-------------------	---



One Globe Bath Light

YB8861



Two Globe Bath Light

YB8862



Three Globe Bath Light

YB8863



Four Globe Bath Light

YB8864



Replacement Globe

YB8869









Bulbs not included.



List price is per each (unless otherwise noted).

Product can be ordered by case quantity or individually.

All 90° lighting Fixtures can be mounted facing either upward or downward.

	MODEL	LIST	FINISH/CONNECT	CASE QTY
ONE-HANDLE BATHROOM FAUCET - PREMIUM				
 <ul style="list-style-type: none"> • application: one hole • supply lines: flexible • connection: 3/8" compression • drain assembly: metal with lift rod • red/blue markings: included <p> DURALAST®</p>	<p> 1.2 GPM (4.5L/min) max.</p>			
	S8000	507.05	Chrome	3
	S8000BLC	785.95	Matte Black/Chrome	3

TWO-HANDLE WIDESPREAD BATHROOM FAUCET TRIM - PREMIUM				
 <ul style="list-style-type: none"> • application: three hole • center dimensions: 8" - 16" center • drain assembly: metal with lift rod • red/blue markings: included • valve: sold separately <p> </p>	<p> 1.2 GPM (4.5L/min) max.</p>			
	TS8002BLC	925.80	Matte Black/Chrome	3

WIDESPREAD FAUCET VALVE				
 <ul style="list-style-type: none"> • application: three hole • center dimensions: 8" - 16" center • drain assembly: metal with lift rod <p> DURALOCK® DURALAST®</p>	9000◆	162.15	1/2" IPS	6

HOW TO ORDER
VALVES: PAGE 463

 TRIM PART # +  VALVE PART # =  COMPLETE FAUCET



Moen® bath accessories CANNOT be combined with Moen faucet parts on a Purchase Order.

COORDINATING ACCESSORIES

Perfectly suited styles for a cohesive look. From robe hooks to towel bars, paper holders to knobs and pulls, Moen offers a variety of coordinating accessories to complete any room.

MODEL NUMBER	LIST EACH	DESCRIPTION	QTY
PREMIUM			
Chrome (CH)			
YB8801CH	83.10	Tank Lever	24
YB8803CH	63.65	Single Robe Hook	24
YB8805CH	16.80	Drawer Knob	48
YB8807CH	33.65	Drawer Pull	48
Ⓜ YB8808CH	117.15	Pivoting Paper Holder	6
YB8818CH	134.80	18" Towel Bar	6
YB8824CH	139.65	24" Towel Bar	6
YB8886CH	94.10	Hand Towel Bar	6

Matte Black (BL)			
YB8801BL	97.75	Tank Lever	24 NEW! Q3
YB8803BL	75.10	Single Robe Hook	24 NEW! Q3
YB8805BL	21.15	Drawer Knob	48 NEW! Q3
YB8807BL	39.60	Drawer Pull	48 NEW! Q3
Ⓜ YB8808BL	137.80	Pivoting Paper Holder	6 NEW! Q3
YB8818BL	158.65	18" Towel Bar	6 NEW! Q3
YB8824BL	164.45	24" Towel Bar	6 NEW! Q3
YB8886BL	110.70	Hand Towel Bar	6 NEW! Q3

Ⓜ Denotes pivoting paper holder



Tank Lever
YB8801



Single Robe Hook
YB8803



Pivoting Paper Holder
YB8808 | Ⓜ



Hand Towel Bar
YB8886



Drawer Knob
YB8805



18" Towel Bar
YB8818



Drawer Pull
YB8807

24" Towel Bar
YB8824

GRAB BARS ♿

MODEL NUMBER	LIST EACH	DESCRIPTION	QTY
PREMIUM			
1½" • Chrome (CH)			
YG8812CH	192.55	12" Designer Grab Bar	6
YG8818CH	201.20	18" Designer Grab Bar	6
YG8824CH	210.20	24" Designer Grab Bar	6
YG8836CH	239.25	36" Designer Grab Bar	6
YG8842CH	352.20	42" Designer Grab Bar	6

1½" • Matte Black (BL)			
YG8812BL	226.85	12" Designer Grab Bar	6 NEW! Q3
YG8818BL	237.75	18" Designer Grab Bar	6 NEW! Q3
YG8824BL	256.55	24" Designer Grab Bar	6 NEW! Q3
YG8836BL	288.90	36" Designer Grab Bar	6 NEW! Q3
YG8842BL	424.40	42" Designer Grab Bar	6 NEW! Q3

SECUREMOUNT™

- SecureMount™ Grab Bars are manufactured with an innovative flange design that makes it easy to connect to the stud at multiple points.
- Tested to withstand 500lbs.
- To install grab bars securely without studs, use SecureMount™ Anchors. Sold separately.









18" Designer Grab Bar
YG8818



VIA®



♿ Complies with Americans with Disabilities Act (ADA) specifications. SecureMount™ Grab Bars are tested to withstand 500 lb. pull when securely installed per instructions.

List price is per each (unless otherwise noted). Product can be ordered by case quantity or individually. For more information on ordering bath accessories, contact Moen Bath Accessory Customer Service at 800-882-0116, contact your local Moen sales representative, or visit us at www.moen.com.

		MODEL	LIST	FINISH/CONNECT	CASE QTY
TOUCHLESS ONE-HANDLE BATHROOM FAUCET - MOTIONSENSE WAVE™ - PREMIUM					
 <p>DECKPLATE INCLUDED</p> 	<ul style="list-style-type: none"> • application: one or three hole • supply lines: flexible • connection: 3/8" compression • deckplate: included • drain assembly: metal • drain assembly type: spring loaded pop-up • DC powered: 6 AA batteries included  <p>DURALOCK® DURALAST®</p>	<p>1.2 GPM (4.5L/min) max.</p>			
		S6910EW	825.90	Chrome	3
		S6910EWBN	1060.80	Brushed Nickel	3
		S6910EWBL	1156.25	Matte Black	3
OPTIONAL AC ADAPTERS SOLD SEPARATELY					
		169031	156.45	N/A or Unfinished	12

ONE-HANDLE BATHROOM FAUCET - PREMIUM					
 <p>DECKPLATE INCLUDED</p> 	<ul style="list-style-type: none"> • application: one or three hole • supply lines: flexible • connection: 3/8" compression • deckplate: included • drain assembly: metal with lift rod  <p>DURALAST®</p>	<p>1.2 GPM (4.5L/min) max.</p>			
		S6910	460.40	Chrome	3
		S6910BN	598.55	Brushed Nickel	3
		S6910BL	644.60	Matte Black	3

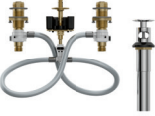
TWO-HANDLE WIDESPREAD BATHROOM FAUCET TRIM - PREMIUM					
	<ul style="list-style-type: none"> • application: three hole • center dimensions: 8" - 16" center • drain assembly: metal with lift rod • valve: sold separately 	<p>1.2 GPM (4.5L/min) max.</p>			
		TS6925	409.60	Chrome	3
		TS6925BN	532.50	Brushed Nickel	3
		TS6925BL	573.45	Matte Black	3

WIDESPREAD FAUCET VALVE					
	<ul style="list-style-type: none"> • application: three hole • center dimensions: 8" - 16" center • drain assembly: metal with lift rod  <p>DURALOCK® DURALAST®</p>	9000◆	162.15	1/2" IPS	6











HOW TO ORDER
VALVES: PAGE 463









TRIM PART #



















VALVE PART #

COMPLETE FAUCET











		MODEL	LIST	FINISH/CONNECT	CASE QTY
FREESTANDING TUB FILLER TRIM - PREMIUM					
 <ul style="list-style-type: none"> • application: one hole • showerhead type: handshower • handshower functions: one-function • handshower flow rate: 1.75 gpm (6.65 L/min) max. • spout reach: 11.00" • mounting kit: sold separately  		S3105	2246.60	Chrome	1
		S3105BN	3032.85	Brushed Nickel	1
		S3105BL	3336.20	Matte Black	1
FREESTANDING TUB FILLER VALVE AND MOUNTING KIT - PREMIUM					
 <ul style="list-style-type: none"> • description: single riser floor joist mounting kit • application: one hole • quarter turn stops: included 		TS50100	400.90	1/2" CC, NPT	2
 <ul style="list-style-type: none"> • description: single riser concrete mounting kit • application: one hole • connection size: 1/2" 		TS50110	325.95	1/2" CC, NPT	2
<p>HOW TO ORDER VALVES: PAGE 463</p>  TRIM PART # +  VALVE PART # =  COMPLETE FAUCET					









ONE-HANDLE WALLMOUNT TUB FILLER TRIM - PREMIUM					
 <ul style="list-style-type: none"> • application: two hole • connection: 1/2" slip fit • tub spout type: non diverter • spout reach: 10.00" • includes: high flow volume control cartridge • WMV130 series valve kit: sold separately  		WTS981	790.25	Chrome	3
		WTS981BN	987.80	Brushed Nickel	3
		WTS981BL	1086.60	Matte Black	3
ONE-HANDLE WALLMOUNT TUB FILLER VALVE KIT					
 <ul style="list-style-type: none"> • application: two hole with adj. center dimensions • ports: three • quarter turn stops: included • includes: test plug • includes: spout manifold 		WMV130CIS	151.05	1/2" CC/IPS	6
		WMV130XS	151.05	1/2" Crimp Ring PEX	6
		WMV130CXS	151.05	1/2" Cold Exp. PEX	6
<p>HOW TO ORDER VALVES: PAGE 463</p>  TRIM PART # +  VALVE PART # =  COMPLETE FAUCET					



















	MODEL	LIST	FINISH/CONNECT	CASE QTY	
TWO-HANDLE ROMAN TUB TRIM - PREMIUM					
 <ul style="list-style-type: none"> • application: three hole • spout reach: 8.40" • valve: sold separately 	TS983	505.40	Chrome	3	
	TS983BN	707.50	Brushed Nickel	3	
	TS983BL	778.25	Matte Black	3	
TWO-HANDLE ROMAN TUB TRIM WITH HANDSHOWER - PREMIUM					
 <ul style="list-style-type: none"> • application: four hole • showerhead type: handshower • handshower flow rate: 1.75 gpm (6.65 L/min) max. • spray functions: one-function • spout reach: 8.40" • valve: sold separately 	TS984	787.25	Chrome	3	
	TS984BN	1102.20	Brushed Nickel	3	
	TS984BL	1212.40	Matte Black	3	
TWO-HANDLE ROMAN TUB VALVE					
 <ul style="list-style-type: none"> • deck thickness: 1/8" to 3-3/8" rough-in deck • adjustable spout shank: adjustable center dimensions 	4792	188.55	1/2" CC	6	
 <ul style="list-style-type: none"> • deck thickness: 1/8" to 2-3/4" rough-in deck • adjustable spout shank: 10" - 24" center dimensions 	4793	213.55	1/2" CPVC, Crimp Ring PEX	6	
	4794	203.60	1/2" Crimp Ring PEX, Cold Exp. PEX	6	
 <ul style="list-style-type: none"> • deck thickness: 1/8" to 3-3/16" rough-in deck • Non-adjustable spout shank: 10" center dimensions 	4796	177.65	1/2" CC	6	
	4797	181.10	1/2" CPVC, Crimp Ring PEX	6	
	4798	181.10	1/2" Crimp Ring PEX, Cold Exp. PEX	6	
TWO-HANDLE ROMAN TUB VALVE WITH HANDSHOWER					
 <ul style="list-style-type: none"> • deck thickness: 1/8" to 2-5/8" rough-in deck • non-adj spout shank: adjustable center dim's 	9792	424.85	1/2" CC	6	
 <ul style="list-style-type: none"> • deck thickness: 1/8" to 2-5/8" rough-in deck • adj spout shank: 10" - 24" center dimensions 	9793	434.80	1/2" CPVC, Crimp Ring PEX	6	
For more product details, reference page 464 in valve section.					
HOW TO ORDER VALVES: PAGE 464	 TRIM PART #	+	 VALVE PART #	=	 COMPLETE FAUCET



DOUX™ Collection





















		MODEL	LIST	FINISH/CONNECT	CASE QTY	
EXACTTEMP® VALVE ONLY TRIM - PREMIUM						
 <ul style="list-style-type: none"> • description: temperature control valve trim • requires: separate volume control valve • valve: sold separately  		TS3101	421.45	Chrome	3	
		TS3101BN	611.05	Brushed Nickel	3	
		TS3101BL	672.15	Matte Black	3	
EXACTTEMP® THERMOSTATIC MIXING SHOWER VALVE - PREMIUM						
 <ul style="list-style-type: none"> • description: thermostatic rough-in valve • ports: four with adjustable temp. limit stops • check stops: included 		S3371	714.65	3/4" IPS	6	
HOW TO ORDER VALVES: PAGE 465		 TRIM PART #	+	 VALVE PART #	=	 COMPLETE FAUCET

EXACTTEMP® VOLUME CONTROL VALVE TRIM - PREMIUM						
 <ul style="list-style-type: none"> • valve: sold separately  		TS3102	194.50	Chrome	6	
		TS3102BN	282.10	Brushed Nickel	6	
		TS3102BL	310.25	Matte Black	6	
EXACTTEMP® VOLUME CONTROL SHOWER VALVE - PREMIUM						
 <ul style="list-style-type: none"> • includes: volume control 		S3600	181.70	3/4" IPS	12	
HOW TO ORDER VALVES: PAGE 465		 TRIM PART #	+	 VALVE PART #	=	 COMPLETE FAUCET











		MODEL	LIST	FINISH/CONNECT	CASE QTY
M-CORE® 4-SERIES TUB/SHOWER TRIM - PREMIUM					
	<ul style="list-style-type: none"> showerhead: single-function eco-performance rainshower showerhead size: 6-3/4" diameter tub spout length: 7 3/4" tub spout connection type: slip fit tub spout type: diverter includes: thermostatic cartridge with volume and temperature control valve: sold separately 	1.75 GPM (6.65 L/min) max.			
		UTS4203EP	780.85	Chrome	4
		UTS4203EPBN	1023.85	Brushed Nickel	4
		UTS4203EPBL	1137.10	Matte Black	4
M-CORE® 4-SERIES SHOWER ONLY TRIM - PREMIUM					
	<ul style="list-style-type: none"> showerhead: single-function eco-performance rainshower showerhead size: 6-3/4" diameter includes: thermostatic cartridge with volume and temperature control valve: sold separately 	1.75 GPM (6.65 L/min) max.			
		UTS4202EP	679.35	Chrome	4
		UTS4202EPBN	861.25	Brushed Nickel	4
		UTS4202EPBL	954.50	Matte Black	4
M-CORE® 4-SERIES VALVE ONLY TRIM - PREMIUM					
	<ul style="list-style-type: none"> includes: thermostatic cartridge with volume and temperature control valve: sold separately 	UTS4201	586.50	Chrome	3
		UTS4201BN	704.30	Brushed Nickel	3
		UTS4201BL	742.30	Matte Black	3
		M-CORE® MIXING SHOWER VALVE			
	<ul style="list-style-type: none"> tub/shower or shower only application ports: four with adj. temp. limit stops included: test plug and cross flow plug 	U140CI	71.20	1/2" CC/IPS	6
		U140X	71.20	1/2" Crimp Ring PEX + CC/IPS Tub	6
		U140CX	71.20	1/2" Cold Exp. PEX + CC/IPS Tub	6
		U140V	87.20	1/2" CPVC + CC/IPS Tub	6
	<ul style="list-style-type: none"> tub/shower or shower only application ports: four with adj. temp. limit stops quarter turn stops: included 	U140CIS	102.45	1/2" CC/IPS	6
		U140XS	102.45	1/2" Crimp Ring PEX + CC/IPS Tub	6
		U140CXS	102.45	1/2" Cold Exp. PEX + CC/IPS Tub	6
		U140VS	118.50	1/2" CPVC + CC/IPS Tub	6
	<ul style="list-style-type: none"> tub/shower only application ports: four with adj. temp. limit stops tub outlet: pre-fabricated 1/2" copper tube included: quarter turn stops and plugs 	U140X-PF	80.40	1/2" Crimp Ring PEX	6
		U140CX-PF	80.40	1/2" Cold Exp. PEX	6
	<ul style="list-style-type: none"> tub/shower only application ports: four with adj. temp. limit stops tub outlet: pre-fabricated 1/2" copper tube included: quarter turn stops and plugs 	U140XS-PF	111.70	1/2" Crimp Ring PEX	6
		U140CXS-PF	111.70	1/2" Cold Exp. PEX	6
	<ul style="list-style-type: none"> shower only application ports: three 	U130CI	71.20	1/2" CC/IPS	6
		U130X	71.20	1/2" Crimp Ring PEX	6
		U130CX	71.20	1/2" Cold Exp. PEX	6
	<ul style="list-style-type: none"> shower only application ports: three quarter turn stops: included 	U130CIS	102.45	1/2" CC/IPS	6
		U130XS	102.45	1/2" Crimp Ring PEX	6
		U130CXS	102.45	1/2" Cold Exp. PEX	6
<p>Four port valves can be used with either Tub/Shower or Shower Only applications. Three port valves can ONLY be used with Shower Only applications. For more product details, reference pages 465-466 in valve section.</p>					
HOW TO ORDER VALVES: PAGES 465-466					













DOUX™ Collection





















		MODEL	LIST	FINISH/CONNECT	CASE QTY	
M-CORE® 3-SERIES TUB/SHOWER TRIM - PREMIUM						
 <ul style="list-style-type: none"> • showerhead: single-function rainshower • showerhead size: 6-3/4" diameter • tub spout length: 7 3/4" • tub spout connection type: slip fit • tub spout type: diverter • includes: pressure balanced cartridge with volume and temperature control • valve: sold separately 		2.5 GPM (9.5 L/min) max.				
		UTS3203	645.85	Chrome	4	
		UTS3203BN	888.85	Brushed Nickel	4	
		UTS3203BL	1002.10	Matte Black	4	
		1.75 GPM (6.65 L/min) max.				
		UTS3203EP	645.85	Chrome	4	
		UTS3203EPBN	888.85	Brushed Nickel	4	
		UTS3203EPBL	1002.10	Matte Black	4	
	M-CORE® 3-SERIES SHOWER ONLY TRIM - PREMIUM					
	 <ul style="list-style-type: none"> • showerhead: single-function rainshower • showerhead size: 6-3/4" diameter • includes: pressure balanced cartridge with volume and temperature control • valve: sold separately 		2.5 GPM (9.5 L/min) max.			
		UTS3202	544.35	Chrome	4	
		UTS3202BN	726.25	Brushed Nickel	4	
		UTS3202BL	819.50	Matte Black	4	
		1.75 GPM (6.65 L/min) max.				
		UTS3202EP	544.35	Chrome	4	
		UTS3202EPBN	726.25	Brushed Nickel	4	
		UTS3202EPBL	819.50	Matte Black	4	
M-CORE® 3-SERIES VALVE ONLY TRIM - PREMIUM						
 <ul style="list-style-type: none"> • includes: pressure balanced cartridge with volume and temperature control • valve: sold separately 		UTS3201	451.50	Chrome	3	
		UTS3201BN	569.30	Brushed Nickel	3	
		UTS3201BL	607.30	Matte Black	3	
	M-CORE® MIXING SHOWER VALVE					
 <ul style="list-style-type: none"> • tub/shower or shower only application • ports: four with adj. temp. limit stops • included: test plug and cross flow plug 		U140CI	71.20	1/2" CC/IPS	6	
		U140X	71.20	1/2" Crimp Ring PEX + CC/IPS Tub	6	
		U140CX	71.20	1/2" Cold Exp. PEX + CC/IPS Tub	6	
		U140V	87.20	1/2" CPVC + CC/IPS Tub	6	
 <ul style="list-style-type: none"> • tub/shower or shower only application • ports: four with adj. temp. limit stops • quarter turn stops: included 		U140CIS	102.45	1/2" CC/IPS	6	
		U140XS	102.45	1/2" Crimp Ring PEX + CC/IPS Tub	6	
		U140CXS	102.45	1/2" Cold Exp. PEX + CC/IPS Tub	6	
		U140VS	118.50	1/2" CPVC + CC/IPS Tub	6	
 <ul style="list-style-type: none"> • tub/shower only application • ports: four with adj. temp. limit stops • tub outlet: pre-fabricated 1/2" copper tube • included: quarter turn stops and plugs 		U140X-PF	80.40	1/2" Crimp Ring PEX	6	
		U140CX-PF	80.40	1/2" Cold Exp. PEX	6	
 <ul style="list-style-type: none"> • tub/shower only application • ports: four with adj. temp. limit stops • tub outlet: pre-fabricated 1/2" copper tube • included: quarter turn stops and plugs 		U140XS-PF	111.70	1/2" Crimp Ring PEX	6	
		U140CXS-PF	111.70	1/2" Cold Exp. PEX	6	
 <ul style="list-style-type: none"> • shower only application • ports: three 		U130CI	71.20	1/2" CC/IPS	6	
		U130X	71.20	1/2" Crimp Ring PEX	6	
		U130CX	71.20	1/2" Cold Exp. PEX	6	
 <ul style="list-style-type: none"> • shower only application • ports: three • quarter turn stops: included 		U130CIS	102.45	1/2" CC/IPS	6	
		U130XS	102.45	1/2" Crimp Ring PEX	6	
		U130CXS	102.45	1/2" Cold Exp. PEX	6	
<p>Four port valves can be used with either Tub/Shower or Shower Only applications. Three port valves can ONLY be used with Shower Only applications. For more product details, reference pages 465-466 in valve section.</p>						
<p>HOW TO ORDER VALVES: PAGES 465-466</p>		 <p>TRIM PART #</p>	+	 <p>VALVE PART #</p>	=	 <p>COMPLETE FAUCET</p>

DOUX™

















		MODEL	LIST	FINISH/CONNECT	CASE QTY		
M-CORE® 3-SERIES WITH INTEGRATED TRANSFER VALVE TRIM - PREMIUM							
 <ul style="list-style-type: none"> • includes: pressure balanced cartridge with volume and temperature control • valve: sold separately  		UTS2611	444.25	Chrome	4		
		UTS2611BN	644.15	Brushed Nickel	4		
		UTS2611BL	708.55	Matte Black	4		
M-CORE® WITH INTEGRATED TRANSFER VALVE							
Three Function (2 independent/1 shared) OR Six Function (3 independent/3 shared) - plumbing configuration page 472							
 <ul style="list-style-type: none"> • ports: four with adj. temp. limit stops • check stops: included 		U362CIS	265.40	1/2" CC/IPS	6		
		U362CXS	265.40	1/2" Cold Exp. PEX	6		
		U362XS	265.40	1/2" Crimp Ring PEX	6		
Two Independent Functions OR Three Independent Functions - plumbing configurations page 472							
 <ul style="list-style-type: none"> • ports: four with adj. temp. limit stops • check stops: included 		U232CIS	265.40	1/2" CC/IPS	6		
		U232CXS	265.40	1/2" Cold Exp. PEX	6		
		U232XS	265.40	1/2" Crimp Ring PEX	6		
For more product details, reference page 466 in valve section. See page 472 for plumbing configurations.							
HOW TO ORDER VALVES: PAGE 466		TRIM PART #	+		=		COMPLETE FAUCET

M-CORE® TRANSFER VALVE TRIM - PREMIUM							
 <ul style="list-style-type: none"> • use with the M-CORE® transfer valve • valve: sold separately  		UTS9204	314.10	Chrome	12		
		UTS9204BN	413.15	Brushed Nickel	12		
		UTS9204BL	445.10	Matte Black	12		
M-CORE® TRANSFER VALVE							
Three Function (2 independent/1 shared) OR Six Function (3 independent/3 shared) - plumbing configuration page 472							
 <ul style="list-style-type: none"> • number of functions: three or six • ports: four 		U361CI	149.70	1/2" CC/IPS	6		
		U361CX	149.70	1/2" Cold Exp. PEX	6		
		U361X	149.70	1/2" Crimp Ring PEX	6		
Two Independent Functions OR Three Independent Functions - plumbing configurations page 472							
 <ul style="list-style-type: none"> • number of functions: two or three • ports: four 		U231CI	149.70	1/2" CC/IPS	6		
		U231CX	149.70	1/2" Cold Exp. PEX	6		
		U231X	149.70	1/2" Crimp Ring PEX	6		
For more product details, reference page 466 in valve section. See page 472 for plumbing configurations.							
HOW TO ORDER VALVES: PAGE 466		TRIM PART #	+		=		COMPLETE FAUCET

DOUX™ Collection















		MODEL	LIST	FINISH/CONNECT	CASE QTY						
M-CORE® 2-SERIES TUB/SHOWER TRIM - PREMIUM											
 <ul style="list-style-type: none"> • showerhead: single-function eco-performance rainshower • showerhead size: 6-3/4" diameter • tub spout length: 7 3/4" • tub spout connection type: slip fit • tub spout type: diverter • includes: pressure balanced cartridge with temperature control • valve: sold separately 	<ul style="list-style-type: none"> • 1.75 GPM (6.65 L/min) max. 	UTS2203EP	575.15	Chrome	4						
		UTS2203EPBN	766.00	Brushed Nickel	4						
		UTS2203EPBL	827.35	Matte Black	4						
M-CORE® 2-SERIES SHOWER ONLY TRIM - PREMIUM											
 <ul style="list-style-type: none"> • showerhead: single-function eco-performance rainshower • showerhead size: 6-3/4" diameter • includes: pressure balanced cartridge with temperature control • valve: sold separately 	<ul style="list-style-type: none"> • 1.75 GPM (6.65 L/min) max. 	UTS2202EP	484.60	Chrome	4						
		UTS2202EPBN	634.60	Brushed Nickel	4						
		UTS2202EPBL	683.05	Matte Black	4						
M-CORE® 2-SERIES VALVE ONLY TRIM - PREMIUM											
 <ul style="list-style-type: none"> • includes: pressure balanced cartridge with temperature control • valve: sold separately 		UTS2201	401.15	Chrome	3						
		UTS2201BN	513.85	Brushed Nickel	3						
		UTS2201BL	550.05	Matte Black	3						
M-CORE® MIXING SHOWER VALVE											
 <ul style="list-style-type: none"> • tub/shower or shower only application • ports: four with adj. temp. limit stops • included: test plug and cross flow plug 		U140CI	71.20	1/2" CC/IPS	6						
		U140X	71.20	1/2" Crimp Ring PEX + CC/IPS Tub	6						
		U140CX	71.20	1/2" Cold Exp. PEX + CC/IPS Tub	6						
		U140V	87.20	1/2" CPVC + CC/IPS Tub	6						
 <ul style="list-style-type: none"> • tub/shower or shower only application • ports: four with adj. temp. limit stops • quarter turn stops: included 		U140CIS	102.45	1/2" CC/IPS	6						
		U140XS	102.45	1/2" Crimp Ring PEX + CC/IPS Tub	6						
		U140CXS	102.45	1/2" Cold Exp. PEX + CC/IPS Tub	6						
		U140VS	118.50	1/2" CPVC + CC/IPS Tub	6						
 <ul style="list-style-type: none"> • tub/shower only application • ports: four with adj. temp. limit stops • tub outlet: pre-fabricated 1/2" copper tube • included: quarter turn stops and plugs 		U140X-PF	80.40	1/2" Crimp Ring PEX	6						
		U140CX-PF	80.40	1/2" Cold Exp. PEX	6						
 <ul style="list-style-type: none"> • tub/shower only application • ports: four with adj. temp. limit stops • tub outlet: pre-fabricated 1/2" copper tube • included: quarter turn stops and plugs 		U140XS-PF	111.70	1/2" Crimp Ring PEX	6						
		U140CXS-PF	111.70	1/2" Cold Exp. PEX	6						
 <ul style="list-style-type: none"> • shower only application • ports: three 		U130CI	71.20	1/2" CC/IPS	6						
		U130X	71.20	1/2" Crimp Ring PEX	6						
		U130CX	71.20	1/2" Cold Exp. PEX	6						
 <ul style="list-style-type: none"> • shower only application • ports: three • quarter turn stops: included 		U130CIS	102.45	1/2" CC/IPS	6						
		U130XS	102.45	1/2" Crimp Ring PEX	6						
		U130CXS	102.45	1/2" Cold Exp. PEX	6						
<p>Four port valves can be used with either Tub/Shower or Shower Only applications. Three port valves can ONLY be used with Shower Only applications. For more product details, reference pages 465-466 in valve section.</p>											
<p>HOW TO ORDER VALVES: PAGES 465-466</p>		 <p>TRIM PART #</p>				+	 <p>VALVE PART #</p>		=	 <p>COMPLETE FAUCET</p>	

DOUX™

		MODEL	LIST	FINISH/CONNECT	CASE QTY	
POSI-TEMP® TUB/SHOWER TRIM - PREMIUM						
 <ul style="list-style-type: none"> • showerhead: single-function rainshower • showerhead size: 6-3/4" diameter • tub spout length: 7 3/4" • tub spout connection type: slip fit • tub spout type: diverter • valve: sold separately 		2.5 GPM (9.5 L/min) max.				
		TS2203	424.10	Chrome	4	
		TS2203BN	615.00	Brushed Nickel	4	
		TS2203BL	676.35	Matte Black	4	
		1.75 GPM (6.65 L/min) max.				
		TS2203EP	424.10	Chrome	4	
		TS2203EPBN	615.00	Brushed Nickel	4	
		TS2203EPBL	676.35	Matte Black	4	
	POSI-TEMP® SHOWER ONLY TRIM - PREMIUM					
	 <ul style="list-style-type: none"> • showerhead: single-function rainshower • showerhead size: 6-3/4" diameter • valve: sold separately 		2.5 GPM (9.5 L/min) max.			
		TS2202	333.55	Chrome	4	
		TS2202BN	483.60	Brushed Nickel	4	
		TS2202BL	532.05	Matte Black	4	
		1.75 GPM (6.65 L/min) max.				
		TS2202EP	333.55	Chrome	4	
		TS2202EPBN	483.60	Brushed Nickel	4	
	TS2202EPBL	532.05	Matte Black	4		
POSI-TEMP® VALVE ONLY TRIM - PREMIUM						
 <ul style="list-style-type: none"> • valve: sold separately 		TS2201	250.15	Chrome	3	
		TS2201BN	362.80	Brushed Nickel	3	
		TS2201BL	399.05	Matte Black	3	
	POSI-TEMP® SHOWER MIXING VALVES					
 <ul style="list-style-type: none"> • tub/shower or shower only application • ports: four with adjustable temp. limit stops • test plug: included 		2520 ◆	156.10	1/2" CC	6	
		2510 ◆	156.10	1/2" IPS	6	
 <ul style="list-style-type: none"> • tub/shower or shower only application • ports: four with adjustable temp. limit stops • quarter turn stops: included • test plug: included 		2570 ◆	189.55	1/2" CC	6	
		2590 ◆	189.55	1/2" IPS	6	
		2580 ◆	156.10	1/2" Crimp ring PEX	6	
	 <ul style="list-style-type: none"> • tub/shower only application • ports: four with adjustable temp. limit stops • quarter turn stops: included • test plug: included 		2360PF	208.45	1/2" Crimp Ring PEX	3
		2385PF	208.45	1/2" Cold Exp. PEX	3	
 <ul style="list-style-type: none"> • shower only application • ports: three with adjustable temp. limit stops • quarter turn stops: included • test plug: included 		2326PF	201.20	1/2" Crimp Ring PEX	6	
		2328PF	201.20	1/2" Cold Exp. PEX	6	
<p>Four port valves can be used with either Tub/Shower or Shower Only applications. Three port valves can ONLY be used with Shower Only applications. For more product details, reference page 467-468 in valve section.</p>						
<p>HOW TO ORDER VALVES: PAGES 467-470</p>		 <p>TRIM PART #</p>	+	 <p>VALVE PART #</p>	=	 <p>COMPLETE FAUCET</p>



DOUX™ Collection

		MODEL	LIST	FINISH/CONNECT	CASE QTY
POSI-TEMP® WITH INTEGRATED TRANSFER VALVE TRIM - PREMIUM					
 <ul style="list-style-type: none"> valve: sold separately  		TS2200	523.05	Chrome	4
		TS2200BN	758.40	Brushed Nickel	4
		TS2200BL	834.30	Matte Black	4
POSI-TEMP® WITH INTEGRATED TRANSFER VALVE					
 <ul style="list-style-type: none"> functions: three (two independent and one shared) ports: four with adjustable temp. limit stops test plug: included 		2551	281.85	1/2" IPS	6
 <ul style="list-style-type: none"> functions: three (two independent and one shared) ports: four with adjustable temp. limit stops stops: included test plug: included 		2581	317.40	1/2" IPS	6
 <ul style="list-style-type: none"> functions: two independent ports: four with adjustable temp. limit stops test plug: included 		2521	281.85	1/2" IPS	6
 <ul style="list-style-type: none"> functions: two independent ports: four with adjustable temp. limit stops stops: included test plug: included 		2571	317.40	1/2" IPS	6
For more product details, reference page 471 in valve section.					
HOW TO ORDER VALVES: PAGE 471	 TRIM PART #	+	 VALVE PART #	=	 COMPLETE FAUCET

Moen® bath accessories CANNOT be combined with Moen faucet parts on a Purchase Order.

A PERFECT MATCH

A line of perfectly matching accessories - including tank levers and towel bars - allow for a completely cohesive look in the bath.

MODEL NUMBER	LIST EACH	DESCRIPTION	QTY
PREMIUM			
Chrome (CH)			
YB0201CH	79.50	Tank Lever	24
YB0203CH	60.90	Single Robe Hook	24
(P) YB0208CH	112.10	Pivoting Paper Holder	6
YB0218CH	128.80	18" Towel Bar	6
YB0224CH	133.45	24" Towel Bar	6
YB0275CH	80.10	Corner Shower Basket	6
YB0286CH	89.95	Towel Ring	6
Brushed Nickel (BN)			
YB0201BN	85.75	Tank Lever	24
YB0203BN	65.30	Single Robe Hook	24
(P) YB0208BN	120.85	Pivoting Paper Holder	6
YB0218BN	139.15	18" Towel Bar	6
YB0224BN	144.25	24" Towel Bar	6
YB0275BN	88.15	Corner Shower Basket	6
YB0286BN	97.05	Towel Ring	6
Matte Black (BL)			
YB0201BL	94.35	Tank Lever	24
YB0203BL	71.65	Single Robe Hook	24
(P) YB0208BL	132.90	Pivoting Paper Holder	6
YB0218BL	153.00	18" Towel Bar	6
YB0224BL	158.75	24" Towel Bar	6
YB0275BL	97.45	Corner Shower Basket	6
YB0286BL	106.75	Towel Ring	6

(P) Denotes pivoting paper holder



Tank Lever

YB0201



Single Robe Hook

YB0203



Pivoting Paper Holder

YB0208 | (P)



Hand Towel Bar

YB0286



18" Towel Bar

YB0218

24" Towel Bar

YB0224











Corner Shower Basket













YB0275

List price is per each (unless otherwise noted).
 Product can be ordered by case quantity or individually.
 For more information on ordering bath accessories, contact Moen Bath Accessory
 Customer Service at **800-882-0116**, contact your local Moen sales representative,
 or visit us at www.moen.com.







GREENFIELD™ Collection **NEW!** Q3











	MODEL	LIST	FINISH/CONNECT	CASE QTY																
ONE-HANDLE BATHROOM FAUCET																				
 DECKPLATE SOLD SEPARATELY  	<ul style="list-style-type: none"> • application: one or three hole • supply lines: flexible • connection: 3/8" compression • deckplate: sold separately • drain assembly: metal with lift rod 																			
	<ul style="list-style-type: none"> •  DURALAST® 																			
<p>1.2 GPM (4.5L/min) max.</p> <table border="1"> <tr> <td>6504</td> <td>356.45</td> <td>Chrome</td> <td>3</td> </tr> <tr> <td>6504BN</td> <td>445.60</td> <td>Brushed Nickel</td> <td>3</td> </tr> <tr> <td>6504BL</td> <td>481.25</td> <td>Matte Black</td> <td>3</td> </tr> <tr> <td>6504BG</td> <td>516.90</td> <td>Brushed Gold</td> <td>3</td> </tr> </table>					6504	356.45	Chrome	3	6504BN	445.60	Brushed Nickel	3	6504BL	481.25	Matte Black	3	6504BG	516.90	Brushed Gold	3
6504	356.45	Chrome	3																	
6504BN	445.60	Brushed Nickel	3																	
6504BL	481.25	Matte Black	3																	
6504BG	516.90	Brushed Gold	3																	
OPTIONAL DECKPLATE SOLD SEPARATELY																				
<table border="1"> <tr> <td>213293</td> <td>19.10</td> <td>Chrome</td> <td>12</td> </tr> <tr> <td>213293BN</td> <td>23.70</td> <td>Brushed Nickel</td> <td>12</td> </tr> <tr> <td>213293BL</td> <td>33.35</td> <td>Matte Black</td> <td>12</td> </tr> <tr> <td>213293BG</td> <td>23.70</td> <td>Brushed Gold</td> <td>12</td> </tr> </table>					213293	19.10	Chrome	12	213293BN	23.70	Brushed Nickel	12	213293BL	33.35	Matte Black	12	213293BG	23.70	Brushed Gold	12
213293	19.10	Chrome	12																	
213293BN	23.70	Brushed Nickel	12																	
213293BL	33.35	Matte Black	12																	
213293BG	23.70	Brushed Gold	12																	

TWO-HANDLE WIDESPREAD BATHROOM FAUCET																				
 	<ul style="list-style-type: none"> • application: three hole • center dimensions: 8" - 16" center • drain assembly: metal with lift rod • 9000 valve included 																			
	<ul style="list-style-type: none"> •   DURALOCK® DURALAST® 																			
<p>1.2 GPM (4.5L/min) max.</p> <table border="1"> <tr> <td>TV6507</td> <td>538.20</td> <td>Chrome</td> <td>3</td> </tr> <tr> <td>TV6507BN</td> <td>672.75</td> <td>Brushed Nickel</td> <td>3</td> </tr> <tr> <td>TV6507BL</td> <td>726.55</td> <td>Matte Black</td> <td>3</td> </tr> <tr> <td>TV6507BG</td> <td>780.40</td> <td>Brushed Gold</td> <td>3</td> </tr> </table>					TV6507	538.20	Chrome	3	TV6507BN	672.75	Brushed Nickel	3	TV6507BL	726.55	Matte Black	3	TV6507BG	780.40	Brushed Gold	3
TV6507	538.20	Chrome	3																	
TV6507BN	672.75	Brushed Nickel	3																	
TV6507BL	726.55	Matte Black	3																	
TV6507BG	780.40	Brushed Gold	3																	







FREESTANDING TUB FILLER TRIM					
 	<ul style="list-style-type: none"> • application: one hole • showerhead type: handshower • handshower functions: one-function • handshower flow rate: 1.75 gpm (6.65 L/min) max. • spout reach: 10.00" • mounting kit: sold separately 				
	<ul style="list-style-type: none"> •   				
FREESTANDING TUB FILLER VALVE AND MOUNTING KIT - PREMIUM					
	<ul style="list-style-type: none"> • description: single riser floor joist mounting kit • application: one hole • quarter turn stops: included 	TS50100	400.90	1/2" CC, NPT	2
	<ul style="list-style-type: none"> •  				
	<ul style="list-style-type: none"> • description: single riser concrete mounting kit • application: one hole • connection size: 1/2" 	TS50110	325.95	1/2" CC, NPT	2
	<ul style="list-style-type: none"> •  				
<p>HOW TO ORDER VALVES: PAGE 463</p>  TRIM PART #   VALVE PART #   COMPLETE FAUCET					







NEW! Q3 **GREENFIELD™** Collection

	MODEL	LIST	FINISH/CONNECT	CASE QTY
ONE-HANDLE WALLMOUNT TUB FILLER TRIM				
 <p>NEW! Q3</p> <ul style="list-style-type: none"> • application: two hole • connection: 1/2" slip fit • tub spout type: non diverter • spout reach: 10.00" • includes: high flow volume control cartridge • WMV130 series valve kit: sold separately 	WT621	720.25	Chrome	3
	WT621BN	965.15	Brushed Nickel	3
	WT621BG	965.15	Brushed Gold	3
	WT621BL	1061.60	Matte Black	3
	ONE-HANDLE WALLMOUNT TUB FILLER VALVE KIT			
 <ul style="list-style-type: none"> • application: two hole with adj. center dimensions • ports: three • quarter turn stops: included • includes: test plug • includes: spout manifold 	WMV130CIS	151.05	1/2" CC/IPS	6
	WMV130XS	151.05	1/2" Crimp Ring PEX	6
	WMV130CXS	151.05	1/2" Cold Exp. PEX	6
<p>HOW TO ORDER VALVES: PAGE 463</p>  <p>TRIM PART #</p> <p>+</p>  <p>VALVE PART #</p> <p>=</p>  <p>COMPLETE FAUCET</p>				



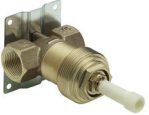



















TWO-HANDLE ROMAN TUB TRIM				
 <p>NEW! Q3</p> <ul style="list-style-type: none"> • application: three hole • spout reach: 7.25" • valve: sold separately 	T6503	523.85	Chrome	3
	T6503BN	731.95	Brushed Nickel	3
	T6503BG	731.95	Brushed Gold	3
	T6503BL	775.70	Matte Black	3
	TWO-HANDLE ROMAN TUB VALVE			
 <ul style="list-style-type: none"> • deck thickness: 1/8" to 3-3/8" rough-in deck • adjustable spout shank: adjustable center dimensions  <p>DURALAST®</p>	4792	188.55	1/2" CC	6
	 <ul style="list-style-type: none"> • deck thickness: 1/8" to 2-3/4" rough-in deck • adjustable spout shank: 10" - 24" center dimensions  <p>DURALOCK® DURALAST®</p>	4793	213.55	1/2" CPVC, Crimp Ring PEX
 <ul style="list-style-type: none"> • deck thickness: 1/8" to 3-3/16" rough-in deck • Non-adjustable spout shank: 10" center dimensions  <p>DURALAST®</p>		4796	177.65	1/2" CC
	4797	181.10	1/2" CPVC, Crimp Ring PEX	6
	4798	181.10	1/2" Crimp Ring PEX, Cold Exp. PEX	6
For more product details, reference page 464 in valve section.				
<p>HOW TO ORDER VALVES: PAGE 464</p>  <p>TRIM PART #</p> <p>+</p>  <p>VALVE PART #</p> <p>=</p>  <p>COMPLETE FAUCET</p>				

GREENFIELD™ Collection **NEW!** Q3

		MODEL	LIST	FINISH/CONNECT	CASE QTY	
EXACTTEMP® VALVE ONLY TRIM						
 <p>NEW! Q3</p> <ul style="list-style-type: none"> • description: temperature control valve trim • requires: separate volume control valve • valve: sold separately 		T4401	303.55	Chrome	3	
		T4401BN	458.40	Brushed Nickel	3	
		T4401BG	458.40	Brushed Gold	3	
		T4401BL	493.25	Matte Black	3	
	EXACTTEMP® THERMOSTATIC MIXING SHOWER VALVE - PREMIUM					
 <ul style="list-style-type: none"> • description: thermostatic rough-in valve • ports: four with adjustable temp. limit stops • check stops: included 		S3371	714.65	3/4" IPS	6	
<p>HOW TO ORDER VALVES: PAGE 465</p>		 <p>TRIM PART #</p>	+	 <p>VALVE PART #</p>	=	 <p>COMPLETE FAUCET</p>

















EXACTTEMP® VOLUME CONTROL VALVE TRIM						
 <p>NEW! Q3</p> <ul style="list-style-type: none"> • valve: sold separately 		T4402	154.50	Chrome	6	
		T4402BN	232.90	Brushed Nickel	6	
		T4402BG	232.90	Brushed Gold	6	
		T4402BL	251.15	Matte Black	6	
	EXACTTEMP® VOLUME CONTROL SHOWER VALVE - PREMIUM					
 <ul style="list-style-type: none"> • includes: volume control 		S3600	181.70	3/4" IPS	12	
<p>HOW TO ORDER VALVES: PAGE 465</p>		 <p>TRIM PART #</p>	+	 <p>VALVE PART #</p>	=	 <p>COMPLETE FAUCET</p>

NEW! Q3 **GREENFIELD™** Collection

			MODEL	LIST	FINISH/CONNECT	CASE QTY
M-CORE® 4-SERIES TUB/SHOWER TRIM						
	<ul style="list-style-type: none"> • showerhead: single-function eco-performance rainshower • showerhead size: 6-3/4" diameter • tub spout length: 7-3/8" • tub spout connection type: slip fit • tub spout type: diverter • includes: thermostatic cartridge with volume and temperature control • valve: sold separately 		1.75 GPM (6.65 L/min) max.			
			UT4323EP	643.35	Chrome	4
			UT4323EPBN	982.10	Brushed Nickel	4
			UT4323EPBG	982.10	Brushed Gold	4
			UT4323EPBL	1066.80	Matte Black	4
M-CORE® 4-SERIES SHOWER ONLY TRIM						
	<ul style="list-style-type: none"> • showerhead: single-function eco-performance rainshower • showerhead size: 6-3/4" diameter • includes: thermostatic cartridge with volume and temperature control • valve: sold separately 		1.75 GPM (6.65 L/min) max.			
			UT4322EP	549.15	Chrome	4
			UT4322EPBN	831.00	Brushed Nickel	4
			UT4322EPBG	831.00	Brushed Gold	4
			UT4322EPBL	900.60	Matte Black	4
M-CORE® 4-SERIES VALVE ONLY TRIM						
	<ul style="list-style-type: none"> • includes: thermostatic cartridge with volume and temperature control • valve: sold separately 		UT4321	483.05	Chrome	3
			UT4321BN	706.30	Brushed Nickel	3
			UT4321BG	706.30	Brushed Gold	3
			UT4321BL	763.40	Matte Black	3
			M-CORE® MIXING SHOWER VALVE			
	<ul style="list-style-type: none"> • tub/shower or shower only application • ports: four with adj. temp. limit stops • included: test plug and cross flow plug 		U140CI	71.20	1/2" CC/IPS	6
			U140X	71.20	1/2" Crimp Ring PEX + CC/IPS Tub	6
			U140CX	71.20	1/2" Cold Exp. PEX + CC/IPS Tub	6
			U140V	87.20	1/2" CPVC + CC/IPS Tub	6
	<ul style="list-style-type: none"> • tub/shower or shower only application • ports: four with adj. temp. limit stops • quarter turn stops: included 		U140CIS	102.45	1/2" CC/IPS	6
			U140XS	102.45	1/2" Crimp Ring PEX + CC/IPS Tub	6
			U140CXS	102.45	1/2" Cold Exp. PEX + CC/IPS Tub	6
			U140VS	118.50	1/2" CPVC + CC/IPS Tub	6
	<ul style="list-style-type: none"> • tub/shower only application • ports: four with adj. temp. limit stops • tub outlet: pre-fabricated 1/2" copper tube • included: quarter turn stops and plugs 		U140X-PF	80.40	1/2" Crimp Ring PEX	6
			U140CX-PF	80.40	1/2" Cold Exp. PEX	6
	<ul style="list-style-type: none"> • tub/shower only application • ports: four with adj. temp. limit stops • tub outlet: pre-fabricated 1/2" copper tube • included: quarter turn stops and plugs 		U140XS-PF	111.70	1/2" Crimp Ring PEX	6
			U140CXS-PF	111.70	1/2" Cold Exp. PEX	6
	<ul style="list-style-type: none"> • shower only application • ports: three 		U130CI	71.20	1/2" CC/IPS	6
			U130X	71.20	1/2" Crimp Ring PEX	6
			U130CX	71.20	1/2" Cold Exp. PEX	6
	<ul style="list-style-type: none"> • shower only application • ports: three • quarter turn stops: included 		U130CIS	102.45	1/2" CC/IPS	6
			U130XS	102.45	1/2" Crimp Ring PEX	6
			U130CXS	102.45	1/2" Cold Exp. PEX	6
<p>Four port valves can be used with either Tub/Shower or Shower Only applications. Three port valves can ONLY be used with Shower Only applications. For more product details, reference pages 465-466 in valve section.</p>						
HOW TO ORDER VALVES: PAGES 465-466		 TRIM PART #   VALVE PART #   COMPLETE FAUCET				

















GREENFIELD™

GREENFIELD™ Collection **NEW!** Q3











		MODEL	LIST	FINISH/CONNECT	CASE QTY	
M-CORE® 3-SERIES TUB/SHOWER TRIM						
 <ul style="list-style-type: none"> • showerhead: single-function rainshower • showerhead size: 6-3/4" diameter • tub spout length: 7-3/8" • tub spout connection type: slip fit • tub spout type: diverter • includes: pressure balanced cartridge with volume and temperature control • valve: sold separately 		2.5 GPM (9.5 L/min) max.				
		UT33323	508.35	Chrome	4	
		UT33323BN	847.10	Brushed Nickel	4	
		UT33323BG	847.10	Brushed Gold	4	
		UT33323BL	931.80	Matte Black	4	
		1.75 GPM (6.65 L/min) max.				
		UT33323EP	508.35	Chrome	4	
		UT33323EPBN	847.10	Brushed Nickel	4	
		UT33323EPBG	847.10	Brushed Gold	4	
		UT33323EPBL	931.80	Matte Black	4	
	M-CORE® 3-SERIES SHOWER ONLY TRIM					
	 <ul style="list-style-type: none"> • showerhead: single-function rainshower • showerhead size: 6-3/4" diameter • includes: pressure balanced cartridge with volume and temperature control • valve: sold separately 		2.5 GPM (9.5 L/min) max.			
		UT33322	414.15	Chrome	4	
		UT33322BN	696.00	Brushed Nickel	4	
		UT33322BG	696.00	Brushed Gold	4	
		UT33322BL	765.60	Matte Black	4	
		1.75 GPM (6.65 L/min) max.				
		UT33322EP	414.15	Chrome	4	
		UT33322EPBN	696.00	Brushed Nickel	4	
		UT33322EPBG	696.00	Brushed Gold	4	
		UT33322EPBL	765.60	Matte Black	4	
M-CORE® MIXING SHOWER VALVE						
 <ul style="list-style-type: none"> • tub/shower or shower only application • ports: four with adj. temp. limit stops • included: test plug and cross flow plug 			U140CI	71.20	1/2" CC/IPS	6
		U140X	71.20	1/2" Crimp Ring PEX + CC/IPS Tub	6	
		U140CX	71.20	1/2" Cold Exp. PEX + CC/IPS Tub	6	
		U140V	87.20	1/2" CPVC + CC/IPS Tub	6	
 <ul style="list-style-type: none"> • tub/shower or shower only application • ports: four with adj. temp. limit stops • quarter turn stops: included 		U140CIS	102.45	1/2" CC/IPS	6	
		U140XS	102.45	1/2" Crimp Ring PEX + CC/IPS Tub	6	
		U140CXS	102.45	1/2" Cold Exp. PEX + CC/IPS Tub	6	
		U140VS	118.50	1/2" CPVC + CC/IPS Tub	6	
 <ul style="list-style-type: none"> • tub/shower only application • ports: four with adj. temp. limit stops • tub outlet: pre-fabricated 1/2" copper tube • included: quarter turn stops and plugs 		U140X-PF	80.40	1/2" Crimp Ring PEX	6	
		U140CX-PF	80.40	1/2" Cold Exp. PEX	6	
 <ul style="list-style-type: none"> • tub/shower only application • ports: four with adj. temp. limit stops • tub outlet: pre-fabricated 1/2" copper tube • included: quarter turn stops and plugs 		U140XS-PF	111.70	1/2" Crimp Ring PEX	6	
		U140CXS-PF	111.70	1/2" Cold Exp. PEX	6	
 <ul style="list-style-type: none"> • shower only application • ports: three 		U130CI	71.20	1/2" CC/IPS	6	
		U130X	71.20	1/2" Crimp Ring PEX	6	
		U130CX	71.20	1/2" Cold Exp. PEX	6	
 <ul style="list-style-type: none"> • shower only application • ports: three • quarter turn stops: included 		U130CIS	102.45	1/2" CC/IPS	6	
		U130XS	102.45	1/2" Crimp Ring PEX	6	
		U130CXS	102.45	1/2" Cold Exp. PEX	6	
<p>Four port valves can be used with either Tub/Shower or Shower Only applications. Three port valves can ONLY be used with Shower Only applications. For more product details, reference pages 465-466 in valve section.</p>						
<p>HOW TO ORDER VALVES: PAGES 465-466</p>						











GREENFIELD™

NEW! Q3 **GREENFIELD™** Collection



















		MODEL	LIST	FINISH/CONNECT	CASE QTY	
M-CORE® 3-SERIES VALVE ONLY TRIM						
 <p>NEW! Q3</p> <ul style="list-style-type: none"> includes: pressure balanced cartridge with volume and temperature control valve: sold separately 		UT33321	348.05	Chrome	3	
		UT33321BN	571.30	Brushed Nickel	3	
		UT33321BG	571.30	Brushed Gold	3	
		UT33321BL	628.40	Matte Black	3	
		M-CORE® MIXING SHOWER VALVE				
 <ul style="list-style-type: none"> tub/shower or shower only application ports: four with adj. temp. limit stops included: test plug and cross flow plug 		U140CI	71.20	1/2" CC/IPS	6	
		U140X	71.20	1/2" Crimp Ring PEX + CC/IPS Tub	6	
		U140CX	71.20	1/2" Cold Exp. PEX + CC/IPS Tub	6	
		U140V	87.20	1/2" CPVC + CC/IPS Tub	6	
 <ul style="list-style-type: none"> tub/shower or shower only application ports: four with adj. temp. limit stops quarter turn stops: included 		U140CIS	102.45	1/2" CC/IPS	6	
		U140XS	102.45	1/2" Crimp Ring PEX + CC/IPS Tub	6	
		U140CXS	102.45	1/2" Cold Exp. PEX + CC/IPS Tub	6	
		U140VS	118.50	1/2" CPVC + CC/IPS Tub	6	
 <ul style="list-style-type: none"> tub/shower only application ports: four with adj. temp. limit stops tub outlet: pre-fabricated 1/2" copper tube included: quarter turn stops and plugs 		U140X-PF	80.40	1/2" Crimp Ring PEX	6	
		U140CX-PF	80.40	1/2" Cold Exp. PEX	6	
 <ul style="list-style-type: none"> tub/shower only application ports: four with adj. temp. limit stops tub outlet: pre-fabricated 1/2" copper tube included: quarter turn stops and plugs 		U140XS-PF	111.70	1/2" Crimp Ring PEX	6	
		U140CXS-PF	111.70	1/2" Cold Exp. PEX	6	
 <ul style="list-style-type: none"> shower only application ports: three 		U130CI	71.20	1/2" CC/IPS	6	
		U130X	71.20	1/2" Crimp Ring PEX	6	
		U130CX	71.20	1/2" Cold Exp. PEX	6	
 <ul style="list-style-type: none"> shower only application ports: three quarter turn stops: included 		U130CIS	102.45	1/2" CC/IPS	6	
		U130XS	102.45	1/2" Crimp Ring PEX	6	
		U130CXS	102.45	1/2" Cold Exp. PEX	6	
<p>Four port valves can be used with either Tub/Shower or Shower Only applications. Three port valves can ONLY be used with Shower Only applications. For more product details, reference pages 465-466 in valve section.</p>						
<p>HOW TO ORDER VALVES: PAGES 465-466</p>		 <p>TRIM PART #</p>	+	 <p>VALVE PART #</p>	=	 <p>COMPLETE FAUCET</p>

GREENFIELD™ Collection **NEW!** Q3

		MODEL	LIST	FINISH/CONNECT	CASE QTY			
M-CORE® 3-SERIES WITH INTEGRATED TRANSFER VALVE TRIM								
 <p>NEW! Q3</p> <ul style="list-style-type: none"> includes: pressure balanced cartridge with volume and temperature control valve: sold separately  		UT33341	328.90	Chrome	4			
		UT33341BN	407.75	Brushed Nickel	4			
		UT33341BG	407.75	Brushed Gold	4			
		UT33341BL	448.55	Matte Black	4			
	M-CORE® WITH INTEGRATED TRANSFER VALVE							
Three Function (2 independent/1 shared) OR Six Function (3 independent/3 shared) - plumbing configuration page 472								
 <ul style="list-style-type: none"> ports: four with adj. temp. limit stops check stops: included 		U362CIS	265.40	1/2" CC/IPS	6			
		U362CXS	265.40	1/2" Cold Exp. PEX	6			
		U362XS	265.40	1/2" Crimp Ring PEX	6			
Two Independent Functions OR Three Independent Functions - plumbing configurations page 472								
 <ul style="list-style-type: none"> ports: four with adj. temp. limit stops check stops: included 		U232CIS	265.40	1/2" CC/IPS	6			
		U232CXS	265.40	1/2" Cold Exp. PEX	6			
		U232XS	265.40	1/2" Crimp Ring PEX	6			
For more product details, reference page 466 in valve section. See page 472 for plumbing configurations.								
HOW TO ORDER VALVES: PAGE 466		TRIM PART #	+		VALVE PART #	=		COMPLETE FAUCET

















M-CORE® TRANSFER VALVE TRIM								
 <p>NEW! Q3</p> <ul style="list-style-type: none"> use with the M-CORE® transfer valve valve: sold separately  		UT6501	227.70	Chrome	12			
		UT6501BN	280.30	Brushed Nickel	12			
		UT6501BG	280.30	Brushed Gold	12			
		UT6501BL	300.80	Matte Black	12			
	M-CORE® TRANSFER VALVE							
Three Function (2 independent/1 shared) OR Six Function (3 independent/3 shared) - plumbing configuration page 472								
 <ul style="list-style-type: none"> number of functions: three or six ports: four 		U361CI	149.70	1/2" CC/IPS	6			
		U361CX	149.70	1/2" Cold Exp. PEX	6			
		U361X	149.70	1/2" Crimp Ring PEX	6			
Two Independent Functions OR Three Independent Functions - plumbing configurations page 472								
 <ul style="list-style-type: none"> number of functions: two or three ports: four 		U231CI	149.70	1/2" CC/IPS	6			
		U231CX	149.70	1/2" Cold Exp. PEX	6			
		U231X	149.70	1/2" Crimp Ring PEX	6			
For more product details, reference page 466 in valve section. See page 472 for plumbing configurations.								
HOW TO ORDER VALVES: PAGE 466		TRIM PART #	+		VALVE PART #	=		COMPLETE FAUCET

NEW! Q3 **GREENFIELD™** Collection

			MODEL	LIST	FINISH/CONNECT	CASE QTY
M-CORE® 2-SERIES TUB/SHOWER TRIM						
	<ul style="list-style-type: none"> • showerhead: single-function eco-performance • showerhead size: 3-5/8" diameter • tub spout length: 7-3/8" • tub spout connection type: slip fit • tub spout type: diverter • includes: pressure balanced cartridge with temperature control • valve: sold separately 		1.75 GPM (6.65 L/min) max.			
			UT2323EP	409.10	Chrome	3
			UT2323EPBN	640.40	Brushed Nickel	3
			UT2323EPBG	640.40	Brushed Gold	3
			UT2323EPBL	691.75	Matte Black	3
M-CORE® 2-SERIES SHOWER ONLY TRIM						
	<ul style="list-style-type: none"> • showerhead: single-function eco-performance • showerhead size: 3-5/8" diameter • includes: pressure balanced cartridge with temperature control • valve: sold separately 		1.75 GPM (6.65 L/min) max.			
			UT2322EP	348.50	Chrome	3
			UT2322EPBN	530.65	Brushed Nickel	3
			UT2322EPBG	530.65	Brushed Gold	3
			UT2322EPBL	571.15	Matte Black	3
M-CORE® 2-SERIES VALVE ONLY TRIM						
	<ul style="list-style-type: none"> • includes: pressure balanced cartridge with temperature control • valve: sold separately 		UT2321	293.05	Chrome	3
			UT2321BN	429.15	Brushed Nickel	3
			UT2321BG	429.15	Brushed Gold	3
			UT2321BL	459.55	Matte Black	3
			M-CORE® MIXING SHOWER VALVE			
	<ul style="list-style-type: none"> • tub/shower or shower only application • ports: four with adj. temp. limit stops • included: test plug and cross flow plug 		U140CI	71.20	1/2" CC/IPS	6
			U140X	71.20	1/2" Crimp Ring PEX + CC/IPS Tub	6
			U140CX	71.20	1/2" Cold Exp. PEX + CC/IPS Tub	6
			U140V	87.20	1/2" CPVC + CC/IPS Tub	6
				<ul style="list-style-type: none"> • tub/shower or shower only application • ports: four with adj. temp. limit stops • quarter turn stops: included 		U140CIS
U140XS	102.45	1/2" Crimp Ring PEX + CC/IPS Tub				6
U140CXS	102.45	1/2" Cold Exp. PEX + CC/IPS Tub				6
U140VS	118.50	1/2" CPVC + CC/IPS Tub				6
	<ul style="list-style-type: none"> • tub/shower only application • ports: four with adj. temp. limit stops • tub outlet: pre-fabricated 1/2" copper tube • included: quarter turn stops and plugs 					U140X-PF
			U140CX-PF	80.40	1/2" Cold Exp. PEX	6
	<ul style="list-style-type: none"> • tub/shower only application • ports: four with adj. temp. limit stops • tub outlet: pre-fabricated 1/2" copper tube • included: quarter turn stops and plugs 		U140XS-PF	111.70	1/2" Crimp Ring PEX	6
			U140CXS-PF	111.70	1/2" Cold Exp. PEX	6
	<ul style="list-style-type: none"> • shower only application • ports: three 		U130CI	71.20	1/2" CC/IPS	6
			U130X	71.20	1/2" Crimp Ring PEX	6
			U130CX	71.20	1/2" Cold Exp. PEX	6
	<ul style="list-style-type: none"> • shower only application • ports: three • quarter turn stops: included 		U130CIS	102.45	1/2" CC/IPS	6
			U130XS	102.45	1/2" Crimp Ring PEX	6
			U130CXS	102.45	1/2" Cold Exp. PEX	6
<p>Four port valves can be used with either Tub/Shower or Shower Only applications. Three port valves can ONLY be used with Shower Only applications. For more product details, reference pages 465-466 in valve section.</p>						
HOW TO ORDER VALVES: PAGES 465-466						



GREENFIELD™ Collection **NEW!** Q3

		MODEL	LIST	FINISH/CONNECT	CASE QTY	
POSI-TEMP® TUB/SHOWER TRIM						
	<ul style="list-style-type: none"> • showerhead: single-function eco-performance • showerhead size: 3-5/8" diameter • tub spout length: 7-3/8" • tub spout connection type: slip fit • tub spout type: diverter • valve: sold separately 	1.75 GPM (6.65 L/min) max.				
		T2223EP	283.05	Chrome	3	
		T2223EPBN	514.25	Brushed Nickel	3	
		T2223EPBG	514.25	Brushed Gold	3	
		T2223EPBL	565.60	Matte Black	3	
POSI-TEMP® SHOWER ONLY TRIM						
	<ul style="list-style-type: none"> • showerhead: single-function eco-performance • showerhead size: 3-5/8" diameter • valve: sold separately 	1.75 GPM (6.65 L/min) max.				
		T2222EP	222.40	Chrome	3	
		T2222EPBN	404.50	Brushed Nickel	3	
		T2222EPBG	404.50	Brushed Gold	3	
		T2222EPBL	445.05	Matte Black	3	
POSI-TEMP® VALVE ONLY TRIM						
	<ul style="list-style-type: none"> • valve: sold separately 	T2221	166.90	Chrome	3	
		T2221BN	303.00	Brushed Nickel	3	
		T2221BG	303.00	Brushed Gold	3	
		T2221BL	333.40	Matte Black	3	
		POSI-TEMP® SHOWER MIXING VALVES				
	<ul style="list-style-type: none"> • tub/shower or shower only application • ports: four with adjustable temp. limit stops • test plug: included 	2520 ◆	156.10	1/2" CC	6	
		2510 ◆	156.10	1/2" IPS	6	
	<ul style="list-style-type: none"> • tub/shower or shower only application • ports: four with adjustable temp. limit stops • quarter turn stops: included • test plug: included 	2570 ◆	189.55	1/2" CC	6	
		2590 ◆	189.55	1/2" IPS	6	
		2580 ◆	156.10	1/2" Crimp ring PEX	6	
		POSI-TEMP® SHOWER MIXING VALVES				
	<ul style="list-style-type: none"> • tub/shower only application • ports: four with adjustable temp. limit stops • quarter turn stops: included • test plug: included 	2360PF	208.45	1/2" Crimp Ring PEX	3	
		2385PF	208.45	1/2" Cold Exp. PEX	3	
	<ul style="list-style-type: none"> • shower only application • ports: three with adjustable temp. limit stops • quarter turn stops: included • test plug: included 	2326PF	201.20	1/2" Crimp Ring PEX	6	
		2328PF	201.20	1/2" Cold Exp. PEX	6	
<p>Four port valves can be used with either Tub/Shower or Shower Only applications. Three port valves can ONLY be used with Shower Only applications. For more product details, reference page 467-468 in valve section.</p>						
<p>HOW TO ORDER VALVES: PAGES 467-470</p>		 <p>TRIM PART #</p>	+	 <p>VALVE PART #</p>	=	 <p>COMPLETE FAUCET</p>

NEW! Q3 **GREENFIELD™** Perfectly Matched Bath Accessories

Moen® bath accessories CANNOT be combined with Moen faucet parts on a Purchase Order.

A PERFECT MATCH

A line of perfectly matching accessories - including tank levers and towel bars - allow for a completely cohesive look in the bath.

MODEL NUMBER	LIST EACH	DESCRIPTION	QTY
Chrome (CH)			
YB1701CH	47.10	Tank Lever	24 NEW! Q3
YB1703CH	36.25	Single Robe Hook	24 NEW! Q3
Ⓟ YB1708CH	66.15	Pivoting Paper Holder	6 NEW! Q3
YB1718CH	76.80	18" Towel Bar	6 NEW! Q3
YB1724CH	79.20	24" Towel Bar	6 NEW! Q3
YB1786CH	53.90	Towel Ring	6 NEW! Q3
YB1788CH	95.90	Double Paper Holder	3 NEW! Q3
YB1794CH	312.10	Towel Shelf	2 NEW! Q3
Brushed Nickel (BN)			
YB1701BN	52.00	Tank Lever	24 NEW! Q3
YB1703BN	39.90	Single Robe Hook	24 NEW! Q3
Ⓟ YB1708BN	73.15	Pivoting Paper Holder	6 NEW! Q3
YB1718BN	84.45	18" Towel Bar	6 NEW! Q3
YB1724BN	87.45	24" Towel Bar	6 NEW! Q3
YB1786BN	58.95	Towel Ring	6 NEW! Q3
YB1788BN	106.10	Double Paper Holder	3 NEW! Q3
YB1794BN	342.30	Towel Shelf	2 NEW! Q3
Matte Black (BL)			
YB1701BL	56.70	Tank Lever	24 NEW! Q3
YB1703BL	43.80	Single Robe Hook	24 NEW! Q3
Ⓟ YB1708BL	80.45	Pivoting Paper Holder	6 NEW! Q3
YB1718BL	92.85	18" Towel Bar	6 NEW! Q3
YB1724BL	96.15	24" Towel Bar	6 NEW! Q3
YB1786BL	64.85	Towel Ring	6 NEW! Q3
YB1788BL	116.65	Double Paper Holder	3 NEW! Q3
YB1794BL	373.15	Towel Shelf	2 NEW! Q3
Brushed Gold (BG)			
YB1701BG	67.60	Tank Lever	24 NEW! Q3
YB1703BG	47.90	Single Robe Hook	24 NEW! Q3
Ⓟ YB1708BG	106.10	Pivoting Paper Holder	6 NEW! Q3
YB1718BG	118.25	18" Towel Bar	6 NEW! Q3
YB1724BG	122.30	24" Towel Bar	6 NEW! Q3
YB1786BG	85.45	Towel Ring	6 NEW! Q3
YB1788BG	153.85	Double Paper Holder	3 NEW! Q3
YB1794BG	445.00	Towel Shelf	2 NEW! Q3

Ⓟ Denotes pivoting paper holder



Tank Lever
YB1701



Single Robe Hook
YB1703



Towel Ring
YB1786



Pivoting Paper Holder
YB1708 | Ⓟ



Double Paper Holder
YB1788



18" Towel Bar
YB1718



24" Towel Bar
YB1724

Towel Shelf
YB1794



List price is per each (unless otherwise noted).
Product can be ordered by case quantity or individually.
For more information on ordering bath accessories, contact Moen Bath Accessory Customer Service at 800-882-0116, contact your local Moen sales representative, or visit us at www.moen.com.



LIGHTING

MODEL NUMBER	LIST EACH	DESCRIPTION	QTY
Chrome (CH)			
YB1761CH	177.10	One Globe Bath Light	1 NEW! Q3
YB1762CH	247.80	Two Globe Bath Light	1 NEW! Q3
YB1763CH	307.80	Three Globe Bath Light	1 NEW! Q3
YB1764CH	394.10	Four Globe Bath Light	1 NEW! Q3
Brushed Nickel (BN)			
YB1761BN	221.45	One Globe Bath Light	1 NEW! Q3
YB1762BN	309.75	Two Globe Bath Light	1 NEW! Q3
YB1763BN	384.70	Three Globe Bath Light	1 NEW! Q3
YB1764BN	492.65	Four Globe Bath Light	1 NEW! Q3
Matte Black (BL)			
YB1761BL	241.40	One Globe Bath Light	1 NEW! Q3
YB1762BL	337.60	Two Globe Bath Light	1 NEW! Q3
YB1763BL	419.30	Three Globe Bath Light	1 NEW! Q3
YB1764BL	537.00	Four Globe Bath Light	1 NEW! Q3
Brushed Gold (BG)			
YB1761BG	265.80	One Globe Bath Light	1 NEW! Q3
YB1762BG	371.70	Two Globe Bath Light	1 NEW! Q3
YB1763BG	461.70	Three Globe Bath Light	1 NEW! Q3
YB1764BG	591.15	Four Globe Bath Light	1 NEW! Q3

Replacement Globe

YB1769	33.45	Replacement Globe	3 NEW! Q3
--------	-------	-------------------	------------------



One Globe Bath Light
YB1761



Two Globe Bath Light
YB1762



Three Globe Bath Light
YB1763



Four Globe Bath Light
YB1764



Replacement Globe
YB1769



Bulbs not included.

List price is per each (unless otherwise noted).







Product can be ordered by case quantity or individually.



One, Three and Four Greenfield lighting fixtures can be mounted facing either upward or downward





Two Globe lighting can be mounted facing either vertically or horizontally without the need to remove the rings.



WYNFORD® Collection

MODEL LIST FINISH/CONNECT CASE QTY

ONE-HANDLE BATHROOM FAUCET				
 DECKPLATE INCLUDED 	<ul style="list-style-type: none"> • application: one or three hole • supply lines: flexible • connection: 3/8" compression • deckplate: included • drain assembly: metal with lift rod 	<p>1.2 GPM (4.5L/min) max.</p>		
	4500	356.45	Chrome	3
	4500BN	481.25	Brushed Nickel	3
	4500ORB	516.90	Oil Rubbed Bronze	3
	<p> DURALAST®</p>			
	<ul style="list-style-type: none"> • application: one hole • supply lines: flexible • connection: 3/8" compression • drain assembly: 140780 sold separately 	<p>1.2 GPM (4.5L/min) max.</p>		
	4507	527.70	Chrome	3
	4507BN	686.05	Brushed Nickel	3
	4507ORB	738.80	Oil Rubbed Bronze	3
	<p> DURALAST®</p>			
OPTION: DRAIN ASSEMBLY				
	<ul style="list-style-type: none"> • drain assembly: metal • drain assembly type: spring loaded pop-up • drain assembly size: 1-1/4" • drain assembly: 1-1/4" non-overflow 			
	140780	76.80	Chrome	12
	140780BN	107.05	Brushed Nickel	12
	140780ORB	128.75	Oil Rubbed Bronze	12

TWO-HANDLE CENTERSET BATHROOM FAUCET				
	<ul style="list-style-type: none"> • application: three hole • center dimensions: 4" center • connection: 1/2" IPS • drain assembly: metal with lift rod 	<p>1.2 GPM (4.5L/min) max.</p>		
	4505	354.30	Chrome	3
	4505BN	478.35	Brushed Nickel	3
	4505ORB	513.75	Oil Rubbed Bronze	3
	<p></p>			

TWO-HANDLE WIDESPREAD BATHROOM FAUCET TRIM				
	<ul style="list-style-type: none"> • application: three hole • center dimensions: 8" - 16" center • drain assembly: metal with lift rod • valve: sold separately 	<p>1.2 GPM (4.5L/min) max.</p>		
	T4520	373.60	Chrome	3
	T4520BN	560.45	Brushed Nickel	3
	T4520ORB	597.80	Oil Rubbed Bronze	3
	<p> </p>			
	<ul style="list-style-type: none"> • application: three hole • center dimensions: 8" - 16" center • drain assembly: metal with lift rod • valve: sold separately 	<p>1.2 GPM (4.5L/min) max.</p>		
	T4524	381.00	Chrome	3
	T4524BN	571.50	Brushed Nickel	3
	T4524ORB	609.60	Oil Rubbed Bronze	3
	<p></p>			











WIDESPREAD FAUCET VALVE				
	<ul style="list-style-type: none"> • application: three hole • center dimensions: 8" - 16" center • drain assembly: metal with lift rod 	9000◆	162.15	1/2" IPS
	<p> DURALOCK® DURALAST®</p>			

HOW TO ORDER
VALVES: PAGE 463

 TRIM PART # +  VALVE PART # =  COMPLETE FAUCET



















WYNFORD® Collection









		MODEL	LIST	FINISH/CONNECT	CASE QTY
FREESTANDING TUB FILLER TRIM					
 <p>CROSS AND LEVER HANDLE INCLUDED</p> 	<ul style="list-style-type: none"> • application: one hole • showerhead type: handshower • handshower functions: one-function • handshower flow rate: 1.75 gpm (6.65 L/min) max. • spout reach: 9.75" • optional cross handle: included • mounting kit: sold separately  	655	1874.95	Chrome	1
		655BN	2531.20	Brushed Nickel	1
		655ORB	2784.35	Oil Rubbed Bronze	1
FREESTANDING TUB FILLER VALVE AND MOUNTING KIT - PREMIUM					
	<ul style="list-style-type: none"> • description: single riser floor joist mounting kit • application: one hole • quarter turn stops: included 	TS50100	400.90	1/2" CC, NPT	2
	<ul style="list-style-type: none"> • description: single riser concrete mounting kit • application: one hole • connection size: 1/2" 	TS50110	325.95	1/2" CC, NPT	2
<p>HOW TO ORDER VALVES: PAGE 463</p>  <p>TRIM PART #</p> <p>+</p>  <p>VALVE PART #</p> <p>=</p>  <p>COMPLETE FAUCET</p>					

























WYNFORD®

	MODEL	LIST	FINISH/CONNECT	CASE QTY	
TWO-HANDLE ROMAN TUB TRIM					
 <ul style="list-style-type: none"> • application: three hole • spout reach: 7.50" • valve: sold separately 	T653	523.85	Chrome	3	
	T653BN	731.95	Brushed Nickel	3	
	T653ORB	805.10	Oil Rubbed Bronze	3	
TWO-HANDLE ROMAN TUB TRIM WITH HANDSHOWER					
 <ul style="list-style-type: none"> • application: four hole • showerhead type: handshower • handshower flow rate: 1.75 gpm (6.65 L/min) max. • spray functions: one-function • spout reach: 7.50" • valve: sold separately 	T654	815.85	Chrome	3	
	T654BN	1343.10	Brushed Nickel	3	
	T654ORB	1477.45	Oil Rubbed Bronze	3	
TWO-HANDLE ROMAN TUB VALVE					
 <ul style="list-style-type: none"> • deck thickness: 1/8" to 3-3/8" rough-in deck • adjustable spout shank: adjustable center dimensions  DURALAST®	4792	188.55	1/2" CC	6	
 <ul style="list-style-type: none"> • deck thickness: 1/8" to 2-3/4" rough-in deck • adjustable spout shank: 10" - 24" center dimensions  DURALOCK® DURALAST®	4793	213.55	1/2" CPVC, Crimp Ring PEX	6	
	4794	203.60	1/2" Crimp Ring PEX, Cold Exp. PEX	6	
 <ul style="list-style-type: none"> • deck thickness: 1/8" to 3-3/16" rough-in deck • Non-adjustable spout shank: 10" center dimensions  DURALAST®	4796	177.65	1/2" CC	6	
	4797	181.10	1/2" CPVC, Crimp Ring PEX	6	
	4798	181.10	1/2" Crimp Ring PEX, Cold Exp. PEX	6	
TWO-HANDLE ROMAN TUB VALVE WITH HANDSHOWER					
 <ul style="list-style-type: none"> • deck thickness: 1/8" to 2-5/8" rough-in deck • non-adj spout shank: adjustable center dim's  DURALAST®	9792	424.85	1/2" CC	6	
 <ul style="list-style-type: none"> • deck thickness: 1/8" to 2-5/8" rough-in deck • adj spout shank: 10" - 24" center dimensions  DURALOCK® DURALAST®	9793	434.80	1/2" CPVC, Crimp Ring PEX	6	
For more product details, reference page 464 in valve section.					
HOW TO ORDER VALVES: PAGE 464	 TRIM PART #	+	 VALVE PART #	=	 COMPLETE FAUCET

WYNFORD® Collection















		MODEL	LIST	FINISH/CONNECT	CASE QTY	
EXACTTEMP® VALVE ONLY TRIM						
 <ul style="list-style-type: none"> • description: temperature control valve trim • requires: separate volume control valve • valve: sold separately  		T6601	304.30	Chrome	3	
		T6601BN	458.40	Brushed Nickel	3	
		T6601ORB	494.50	Oil Rubbed Bronze	3	
EXACTTEMP® THERMOSTATIC MIXING SHOWER VALVE - PREMIUM						
 <ul style="list-style-type: none"> • description: thermostatic rough-in valve • ports: four with adjustable temp. limit stops • check stops: included 		S3371	714.65	3/4" IPS	6	
HOW TO ORDER VALVES: PAGE 465		 TRIM PART #	+	 VALVE PART #	=	 COMPLETE FAUCET

EXACTTEMP® VOLUME CONTROL VALVE TRIM						
 <ul style="list-style-type: none"> • valve: sold separately  		T6602	154.50	Chrome	6	
		T6602BN	232.90	Brushed Nickel	6	
		T6602ORB	251.15	Oil Rubbed Bronze	6	
EXACTTEMP® VOLUME CONTROL SHOWER VALVE - PREMIUM						
 <ul style="list-style-type: none"> • includes: volume control 		S3600	181.70	3/4" IPS	12	
HOW TO ORDER VALVES: PAGE 465		 TRIM PART #	+	 VALVE PART #	=	 COMPLETE FAUCET









	MODEL	LIST	FINISH/CONNECT	CASE QTY				
M-CORE® 4-SERIES TUB/SHOWER TRIM								
 <ul style="list-style-type: none"> showerhead: single-function eco-performance rainshower showerhead size: 7" diameter tub spout length: 7 15/16" tub spout connection type: slip fit tub spout type: diverter includes: thermostatic cartridge with volume and temperature control valve: sold separately 		1.75 GPM (6.65 L/min) max.						
	UT45503EP	643.35	Chrome	4				
	UT45503EPBN	982.10	Brushed Nickel	4				
	UT45503EPORB	1051.70	Oil Rubbed Bronze	4				
								
M-CORE® 4-SERIES SHOWER ONLY TRIM								
 <ul style="list-style-type: none"> showerhead: single-function eco-performance rainshower showerhead size: 7" diameter includes: thermostatic cartridge with volume and temperature control valve: sold separately 		1.75 GPM (6.65 L/min) max.						
	UT45502EP	549.15	Chrome	4				
	UT45502EPBN	831.00	Brushed Nickel	4				
	UT45502EPORB	885.55	Oil Rubbed Bronze	4				
								
M-CORE® 4-SERIES VALVE ONLY TRIM								
 <ul style="list-style-type: none"> includes: thermostatic cartridge with volume and temperature control valve: sold separately 	UT45501	483.05	Chrome	3				
	UT45501BN	706.30	Brushed Nickel	3				
	UT45501ORB	748.50	Oil Rubbed Bronze	3				
M-CORE® MIXING SHOWER VALVE								
 <ul style="list-style-type: none"> tub/shower or shower only application ports: four with adj. temp. limit stops included: test plug and cross flow plug 	U140CI	71.20	1/2" CC/IPS	6				
	U140X	71.20	1/2" Crimp Ring PEX + CC/IPS Tub	6				
	U140CX	71.20	1/2" Cold Exp. PEX + CC/IPS Tub	6				
	U140V	87.20	1/2" CPVC + CC/IPS Tub	6				
 <ul style="list-style-type: none"> tub/shower or shower only application ports: four with adj. temp. limit stops quarter turn stops: included 	U140CIS	102.45	1/2" CC/IPS	6				
	U140XS	102.45	1/2" Crimp Ring PEX + CC/IPS Tub	6				
	U140CXS	102.45	1/2" Cold Exp. PEX + CC/IPS Tub	6				
	U140VS	118.50	1/2" CPVC + CC/IPS Tub	6				
 <ul style="list-style-type: none"> tub/shower only application ports: four with adj. temp. limit stops tub outlet: pre-fabricated 1/2" copper tube included: quarter turn stops and plugs 	U140X-PF	80.40	1/2" Crimp Ring PEX	6				
	U140CX-PF	80.40	1/2" Cold Exp. PEX	6				
 <ul style="list-style-type: none"> tub/shower only application ports: four with adj. temp. limit stops tub outlet: pre-fabricated 1/2" copper tube included: quarter turn stops and plugs 	U140XS-PF	111.70	1/2" Crimp Ring PEX	6				
	U140CXS-PF	111.70	1/2" Cold Exp. PEX	6				
 <ul style="list-style-type: none"> shower only application ports: three 	U130CI	71.20	1/2" CC/IPS	6				
	U130X	71.20	1/2" Crimp Ring PEX	6				
	U130CX	71.20	1/2" Cold Exp. PEX	6				
 <ul style="list-style-type: none"> shower only application ports: three quarter turn stops: included 	U130CIS	102.45	1/2" CC/IPS	6				
	U130XS	102.45	1/2" Crimp Ring PEX	6				
	U130CXS	102.45	1/2" Cold Exp. PEX	6				
<p>Four port valves can be used with either Tub/Shower or Shower Only applications. Three port valves can ONLY be used with Shower Only applications. For more product details, reference pages 465-466 in valve section.</p>								
<p>HOW TO ORDER VALVES: PAGES 465-466</p>	 <p>TRIM PART #</p>				+	 <p>VALVE PART #</p>	=	 <p>COMPLETE FAUCET</p>











WYNFORD® Collection























		MODEL	LIST	FINISH/CONNECT	CASE QTY	
M-CORE® 3-SERIES TUB/SHOWER TRIM						
 <ul style="list-style-type: none"> • showerhead: single-function rainshower • showerhead size: 7" diameter • tub spout length: 7 15/16" • tub spout connection type: slip fit • tub spout type: diverter • includes: pressure balanced cartridge with volume and temperature control • valve: sold separately 		2.5 GPM (9.5 L/min) max.				
		UT35503	508.35	Chrome	4	
		UT35503BN	847.10	Brushed Nickel	4	
		UT35503ORB	916.70	Oil Rubbed Bronze	4	
		1.75 GPM (6.65 L/min) max.				
		UT35503EP	508.35	Chrome	4	
		UT35503EPBN	847.10	Brushed Nickel	4	
		UT35503EPORB	916.70	Oil Rubbed Bronze	4	
						
	M-CORE® 3-SERIES SHOWER ONLY TRIM					
 <ul style="list-style-type: none"> • showerhead: single-function rainshower • showerhead size: 7" diameter • includes: pressure balanced cartridge with volume and temperature control • valve: sold separately 		2.5 GPM (9.5 L/min) max.				
		UT35502	414.15	Chrome	4	
		UT35502BN	696.00	Brushed Nickel	4	
		UT35502ORB	750.55	Oil Rubbed Bronze	4	
		1.75 GPM (6.65 L/min) max.				
		UT35502EP	414.15	Chrome	4	
		UT35502EPBN	696.00	Brushed Nickel	4	
		UT35502EPORB	750.55	Oil Rubbed Bronze	4	
						
	M-CORE® 3-SERIES VALVE ONLY TRIM					
 <ul style="list-style-type: none"> • includes: pressure balanced cartridge with volume and temperature control • valve: sold separately 		UT35501	348.05	Chrome	3	
		UT35501BN	571.30	Brushed Nickel	3	
		UT35501ORB	613.50	Oil Rubbed Bronze	3	
						
M-CORE® MIXING SHOWER VALVE						
 <ul style="list-style-type: none"> • tub/shower or shower only application • ports: four with adj. temp. limit stops • included: test plug and cross flow plug 		U140CI	71.20	1/2" CC/IPS	6	
		U140X	71.20	1/2" Crimp Ring PEX + CC/IPS Tub	6	
		U140CX	71.20	1/2" Cold Exp. PEX + CC/IPS Tub	6	
		U140V	87.20	1/2" CPVC + CC/IPS Tub	6	
 <ul style="list-style-type: none"> • tub/shower or shower only application • ports: four with adj. temp. limit stops • quarter turn stops: included 		U140CIS	102.45	1/2" CC/IPS	6	
		U140XS	102.45	1/2" Crimp Ring PEX + CC/IPS Tub	6	
		U140CXS	102.45	1/2" Cold Exp. PEX + CC/IPS Tub	6	
		U140VS	118.50	1/2" CPVC + CC/IPS Tub	6	
 <ul style="list-style-type: none"> • tub/shower only application • ports: four with adj. temp. limit stops • tub outlet: pre-fabricated 1/2" copper tube • included: quarter turn stops and plugs 		U140X-PF	80.40	1/2" Crimp Ring PEX	6	
		U140CX-PF	80.40	1/2" Cold Exp. PEX	6	
 <ul style="list-style-type: none"> • tub/shower only application • ports: four with adj. temp. limit stops • tub outlet: pre-fabricated 1/2" copper tube • included: quarter turn stops and plugs 		U140XS-PF	111.70	1/2" Crimp Ring PEX	6	
		U140CXS-PF	111.70	1/2" Cold Exp. PEX	6	
 <ul style="list-style-type: none"> • shower only application • ports: three 		U130CI	71.20	1/2" CC/IPS	6	
		U130X	71.20	1/2" Crimp Ring PEX	6	
		U130CX	71.20	1/2" Cold Exp. PEX	6	
 <ul style="list-style-type: none"> • shower only application • ports: three • quarter turn stops: included 		U130CIS	102.45	1/2" CC/IPS	6	
		U130XS	102.45	1/2" Crimp Ring PEX	6	
		U130CXS	102.45	1/2" Cold Exp. PEX	6	
<p>Four port valves can be used with either Tub/Shower or Shower Only applications. Three port valves can ONLY be used with Shower Only applications. For more product details, reference pages 465-466 in valve section.</p>						
<p>HOW TO ORDER VALVES: PAGES 465-466</p>		 <p>TRIM PART #</p>	+	 <p>VALVE PART #</p>	=	 <p>COMPLETE FAUCET</p>

















WYNFORD®

		MODEL	LIST	FINISH/CONNECT	CASE QTY		
M-CORE® 3-SERIES WITH INTEGRATED TRANSFER VALVE TRIM							
 <ul style="list-style-type: none"> • includes: pressure balanced cartridge with volume and temperature control • valve: sold separately 		UT5500	320.90	Chrome	4		
		UT5500BN	407.75	Brushed Nickel	4		
		UT5500ORB	438.65	Oil Rubbed Bronze	4		
M-CORE® WITH INTEGRATED TRANSFER VALVE							
Three Function (2 independent/1 shared) OR Six Function (3 independent/3 shared) - plumbing configuration page 472							
 <ul style="list-style-type: none"> • ports: four with adj. temp. limit stops • check stops: included 		U362CIS	265.40	1/2" CC/IPS	6		
		U362CXS	265.40	1/2" Cold Exp. PEX	6		
		U362XS	265.40	1/2" Crimp Ring PEX	6		
Two Independent Functions OR Three Independent Functions - plumbing configurations page 472							
 <ul style="list-style-type: none"> • ports: four with adj. temp. limit stops • check stops: included 		U232CIS	265.40	1/2" CC/IPS	6		
		U232CXS	265.40	1/2" Cold Exp. PEX	6		
		U232XS	265.40	1/2" Crimp Ring PEX	6		
For more product details, reference page 466 in valve section. See page 472 for plumbing configurations.							
HOW TO ORDER VALVES: PAGE 466		TRIM PART #	+		=		COMPLETE FAUCET

M-CORE® TRANSFER VALVE TRIM							
 <ul style="list-style-type: none"> • use with the M-CORE® transfer valve • valve: sold separately 		UT4511	227.70	Chrome	12		
		UT4511BN	280.30	Brushed Nickel	12		
		UT4511ORB	300.80	Oil Rubbed Bronze	12		
M-CORE® TRANSFER VALVE							
Three Function (2 independent/1 shared) OR Six Function (3 independent/3 shared) - plumbing configuration page 472							
 <ul style="list-style-type: none"> • number of functions: three or six • ports: four 		U361CI	149.70	1/2" CC/IPS	6		
		U361CX	149.70	1/2" Cold Exp. PEX	6		
		U361X	149.70	1/2" Crimp Ring PEX	6		
Two Independent Functions OR Three Independent Functions - plumbing configurations page 472							
 <ul style="list-style-type: none"> • number of functions: two or three • ports: four 		U231CI	149.70	1/2" CC/IPS	6		
		U231CX	149.70	1/2" Cold Exp. PEX	6		
		U231X	149.70	1/2" Crimp Ring PEX	6		
For more product details, reference page 466 in valve section. See page 472 for plumbing configurations.							
HOW TO ORDER VALVES: PAGE 466		TRIM PART #	+		=		COMPLETE FAUCET











WYNFORD® Collection

		MODEL	LIST	FINISH/CONNECT	CASE QTY
M-CORE® 2-SERIES TUB/SHOWER TRIM					
 <ul style="list-style-type: none"> • showerhead: single-function eco-performance rainshower • showerhead size: 5-7/8" diameter • tub spout length: 7 15/16" • tub spout connection type: slip fit • tub spout type: diverter • includes: pressure balanced cartridge with temperature control • valve: sold separately 	<ul style="list-style-type: none"> • 1.75 GPM (6.65 L/min) max. 				
	UT24503EP	409.10	Chrome	3	
	UT24503EPBN	640.40	Brushed Nickel	3	
	UT24503EPORB	692.05	Oil Rubbed Bronze	3	
M-CORE® 2-SERIES SHOWER ONLY TRIM					
 <ul style="list-style-type: none"> • showerhead: single-function eco-performance rainshower • showerhead size: 5-7/8" diameter • includes: pressure balanced cartridge with temperature control • valve: sold separately 	<ul style="list-style-type: none"> • 1.75 GPM (6.65 L/min) max. 				
	UT24502EP	348.50	Chrome	3	
	UT24502EPBN	530.65	Brushed Nickel	3	
	UT24502EPORB	571.05	Oil Rubbed Bronze	3	
M-CORE® 2-SERIES VALVE ONLY TRIM					
 <ul style="list-style-type: none"> • includes: pressure balanced cartridge with temperature control • valve: sold separately 					
	UT24501	293.05	Chrome	3	
	UT24501BN	429.15	Brushed Nickel	3	
	UT24501ORB	459.55	Oil Rubbed Bronze	3	
M-CORE® MIXING SHOWER VALVE					
 <ul style="list-style-type: none"> • tub/shower or shower only application • ports: four with adj. temp. limit stops • included: test plug and cross flow plug 					
	U140CI	71.20	1/2" CC/IPS	6	
	U140X	71.20	1/2" Crimp Ring PEX + CC/IPS Tub	6	
	U140CX	71.20	1/2" Cold Exp. PEX + CC/IPS Tub	6	
 <ul style="list-style-type: none"> • tub/shower or shower only application • ports: four with adj. temp. limit stops • quarter turn stops: included 					
	U140V	87.20	1/2" CPVC + CC/IPS Tub	6	
	U140CIS	102.45	1/2" CC/IPS	6	
	U140XS	102.45	1/2" Crimp Ring PEX + CC/IPS Tub	6	
 <ul style="list-style-type: none"> • tub/shower only application • ports: four with adj. temp. limit stops • tub outlet: pre-fabricated 1/2" copper tube • included: quarter turn stops and plugs 					
	U140CXS	102.45	1/2" Cold Exp. PEX + CC/IPS Tub	6	
	U140VS	118.50	1/2" CPVC + CC/IPS Tub	6	
	U140X-PF	80.40	1/2" Crimp Ring PEX	6	
 <ul style="list-style-type: none"> • tub/shower only application • ports: four with adj. temp. limit stops • tub outlet: pre-fabricated 1/2" copper tube • included: quarter turn stops and plugs 					
	U140CX-PF	80.40	1/2" Cold Exp. PEX	6	
	U140XS-PF	111.70	1/2" Crimp Ring PEX	6	
	U140CXS-PF	111.70	1/2" Cold Exp. PEX	6	
 <ul style="list-style-type: none"> • shower only application • ports: three 					
	U130CI	71.20	1/2" CC/IPS	6	
	U130X	71.20	1/2" Crimp Ring PEX	6	
	U130CX	71.20	1/2" Cold Exp. PEX	6	
 <ul style="list-style-type: none"> • shower only application • ports: three • quarter turn stops: included 					
	U130CIS	102.45	1/2" CC/IPS	6	
	U130XS	102.45	1/2" Crimp Ring PEX	6	
	U130CXS	102.45	1/2" Cold Exp. PEX	6	
Four port valves can be used with either Tub/Shower or Shower Only applications. Three port valves can ONLY be used with Shower Only applications. For more product details, reference pages 465-466 in valve section.					
HOW TO ORDER VALVES: PAGES 465-466		 TRIM PART #   VALVE PART #   COMPLETE FAUCET			

		MODEL	LIST	FINISH/CONNECT	CASE QTY	
POSI-TEMP® TUB/SHOWER TRIM						
 <ul style="list-style-type: none"> • showerhead: single-function standard • showerhead size: 5-7/8" diameter • tub spout length: 7 15/16" • tub spout connection type: slip fit • tub spout type: diverter • valve: sold separately 		2.5 GPM (9.5 L/min) max.				
		T4503	283.05	Chrome	3	
		T4503BN	514.25	Brushed Nickel	3	
		T4503ORB	565.90	Oil Rubbed Bronze	3	
		1.75 GPM (6.65 L/min) max.				
		T4503EP	283.05	Chrome	3	
		T4503EPBN	514.25	Brushed Nickel	3	
		T4503EPORB	565.90	Oil Rubbed Bronze	3	
POSI-TEMP® SHOWER ONLY TRIM						
 <ul style="list-style-type: none"> • showerhead: single-function standard • showerhead size: 5-7/8" diameter • valve: sold separately 		2.5 GPM (9.5 L/min) max.				
		T4502	222.40	Chrome	3	
		T4502BN	404.50	Brushed Nickel	3	
		T4502ORB	444.90	Oil Rubbed Bronze	3	
		1.75 GPM (6.65 L/min) max.				
		T4502EP	222.40	Chrome	3	
		T4502EPBN	404.50	Brushed Nickel	3	
		T4502EPORB	444.90	Oil Rubbed Bronze	3	
POSI-TEMP® VALVE ONLY TRIM						
 <ul style="list-style-type: none"> • valve: sold separately 		T4501	166.90	Chrome	3	
		T4501BN	303.00	Brushed Nickel	3	
		T4501ORB	333.40	Oil Rubbed Bronze	3	
POSI-TEMP® SHOWER MIXING VALVES						
 <ul style="list-style-type: none"> • tub/shower or shower only application • ports: four with adjustable temp. limit stops • test plug: included 		2520 ◆	156.10	1/2" CC	6	
		2510 ◆	156.10	1/2" IPS	6	
 <ul style="list-style-type: none"> • tub/shower or shower only application • ports: four with adjustable temp. limit stops • quarter turn stops: included • test plug: included 		2570 ◆	189.55	1/2" CC	6	
		2590 ◆	189.55	1/2" IPS	6	
		2580 ◆	156.10	1/2" Crimp ring PEX	6	
 <ul style="list-style-type: none"> • tub/shower only application • ports: four with adjustable temp. limit stops • quarter turn stops: included • test plug: included 		2360PF	208.45	1/2" Crimp Ring PEX	3	
		2385PF	208.45	1/2" Cold Exp. PEX	3	
 <ul style="list-style-type: none"> • shower only application • ports: three with adjustable temp. limit stops • quarter turn stops: included • test plug: included 		2326PF	201.20	1/2" Crimp Ring PEX	6	
		2328PF	201.20	1/2" Cold Exp. PEX	6	
<p>Four port valves can be used with either Tub/Shower or Shower Only applications. Three port valves can ONLY be used with Shower Only applications. For more product details, reference page 467-468 in valve section.</p>						
HOW TO ORDER VALVES: PAGES 467-470		 TRIM PART #	+	 VALVE PART #	=	 COMPLETE FAUCET



WYNFORD® Collection

		MODEL	LIST	FINISH/CONNECT	CASE QTY	
POSI-TEMP® WITH INTEGRATED TRANSFER VALVE TRIM						
 <ul style="list-style-type: none"> • valve: sold separately 	 	T4500	301.30	Chrome	4	
		T4500BN	547.05	Brushed Nickel	4	
		T4500ORB	601.90	Oil Rubbed Bronze	4	
POSI-TEMP® WITH INTEGRATED TRANSFER VALVE						
 <ul style="list-style-type: none"> • functions: three (two independent and one shared) • ports: four with adjustable temp. limit stops • test plug: included 		2551	281.85	1/2" IPS	6	
 <ul style="list-style-type: none"> • functions: three (two independent and one shared) • ports: four with adjustable temp. limit stops • stops: included • test plug: included 		2581	317.40	1/2" IPS	6	
 <ul style="list-style-type: none"> • functions: two independent • ports: four with adjustable temp. limit stops • test plug: included 		2521	281.85	1/2" IPS	6	
 <ul style="list-style-type: none"> • functions: two independent • ports: four with adjustable temp. limit stops • stops: included • test plug: included 		2571	317.40	1/2" IPS	6	
For more product details, reference page 471 in valve section.						
HOW TO ORDER VALVES: PAGE 471		 TRIM PART #	+	 VALVE PART #	=	 COMPLETE FAUCET

Moen® bath accessories CANNOT be combined with Moen faucet parts on a Purchase Order.

A PERFECT MATCH

A line of perfectly matching accessories - including tank levers and towel bars - allow for a completely cohesive look in the bath.

MODEL NUMBER	LIST EACH	DESCRIPTION	QTY
Chrome (CH)			
YB5201CH	47.10	Tank Lever	6
YB5203CH	36.25	Double Robe Hook	24
(P) YB5208CH	66.15	Pivoting Paper Holder	6
YB5218CH	76.80	18" Towel Bar	6
YB5222CH	105.15	24" Double Towel Bar	6
YB5224CH	79.20	24" Towel Bar	6
YB5275CH	163.90	Corner Shower Basket	6
YB5286CH	53.90	Towel Ring	6

Brushed Nickel (BN)			
YB5201BN	52.00	Tank Lever	6
YB5203BN	39.90	Double Robe Hook	24
(P) YB5208BN	73.15	Pivoting Paper Holder	6
YB5218BN	84.45	18" Towel Bar	6
YB5222BN	110.85	24" Double Towel Bar	6
YB5224BN	87.45	24" Towel Bar	6
YB5275BN	187.50	Corner Shower Basket	6
YB5286BN	58.95	Towel Ring	6

Oil Rubbed Bronze (ORB)			
YB5201ORB	57.10	Tank Lever	6
YB5203ORB	43.80	Double Robe Hook	24
(P) YB5208ORB	80.50	Pivoting Paper Holder	6
YB5218ORB	92.85	18" Towel Bar	6
YB5222ORB	116.35	24" Double Towel Bar	6
YB5224ORB	96.25	24" Towel Bar	6
YB5286ORB	64.85	Towel Ring	6

Old World Bronze (OWB)			
YB5275OWB	203.20	Corner Shower Basket	6

(P) Denotes pivoting paper holder



Tank Lever
YB5201



Double Robe Hook
YB5203



Towel Ring
YB5286



Pivoting Paper Holder
YB5208 | (P)



18" Towel Bar
YB5218



















24" Double Towel Bar
YB5222





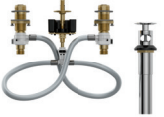



24" Towel Bar
YB5224





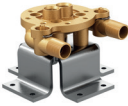





Shower Basket
YB5275

















		MODEL	LIST	FINISH/CONNECT	CASE QTY		
ONE-HANDLE BATHROOM FAUCET							
 <p>DECKPLATE INCLUDED</p> 	<ul style="list-style-type: none"> • application: one or three hole • supply lines: flexible • connection: 3/8" compression • deckplate: included • drain assembly: metal with lift rod • red/blue markings: included <p> DURALAST®</p>	1.2 GPM (4.5L/min) max.					
		6190	356.45	Chrome	3		
		6190BN	481.25	Brushed Nickel	3		
		6190BL	516.90	Matte Black	3		
		6190BG	516.90	Brushed Gold	3		
 <p>DECKPLATE SOLD SEPARATELY</p> 	<ul style="list-style-type: none"> • application: one or three hole • supply lines: flexible • connection: 3/8" compression • deckplate: sold separately • drain assembly: metal with lift rod • red/blue markings: included <p> DURALAST®</p>	1.2 GPM (4.5L/min) max.					
		6191	346.90	Chrome	3		
		6191BN	468.30	Brushed Nickel	3		
		6191BL	485.65	Matte Black	3		
		6191BG	503.00	Brushed Gold	3		
		OPTIONAL DECKPLATE SOLD SEPARATELY					
		172666	19.10	Chrome	20		
		172666BN	23.70	Brushed Nickel	20		
		172666BL	33.35	Matte Black	20		
172666BG	23.70	Brushed Gold	20				
 <p>DECKPLATE SOLD SEPARATELY</p> 	<ul style="list-style-type: none"> • application: one or three hole • supply lines: flexible • connection: 3/8" compression • deckplate: sold separately • drain assembly: 140780 sold separately • red/blue markings: included <p> DURALAST®</p>	1.2 GPM (4.5L/min) max.					
		6192	527.70	Chrome	3		
		6192BN	686.05	Brushed Nickel	3		
		6192BL	712.40	Matte Black	3		
		6192BG	765.20	Brushed Gold	3		
		OPTIONAL DECKPLATE SOLD SEPARATELY					
		172666	19.10	Chrome	20		
		172666BN	23.70	Brushed Nickel	20		
		172666BL	33.35	Matte Black	20		
		172666BG	23.70	Brushed Gold	20		
OPTION: DRAIN ASSEMBLY							
	<ul style="list-style-type: none"> • drain assembly: metal • drain assembly type: spring loaded pop-up • drain assembly size: 1-1/4" • drain assembly: 1-1/4" non-overflow 	140780	76.80	Chrome	12		
		140780BN	107.05	Brushed Nickel	12		
		140780BL	120.90	Matte Black	12		
		140780BG	107.05	Brushed Gold	12		









TWO-HANDLE WIDESPREAD BATHROOM FAUCET TRIM					
	<ul style="list-style-type: none"> • application: three hole • center dimensions: 8" - 16" center • drain assembly: metal with lift rod • valve: sold separately <p> </p>	1.2 GPM (4.5L/min) max.			
		T6193	370.20	Chrome	3
		T6193BN	573.75	Brushed Nickel	3
		T6193BL	592.30	Matte Black	3
		T6193BG	610.80	Brushed Gold	3
WIDESPREAD FAUCET VALVE					
	<ul style="list-style-type: none"> • application: three hole • center dimensions: 8" - 16" center • drain assembly: metal with lift rod <p> DURALOCK® DURALAST®</p>	9000◆	162.15	1/2" IPS	6
<p>HOW TO ORDER VALVES: PAGE 463</p> <p style="text-align: center;">  TRIM PART # +  VALVE PART # =  COMPLETE FAUCET </p>					







		MODEL	LIST	FINISH/CONNECT	CASE QTY	
FREESTANDING TUB FILLER TRIM						
 <ul style="list-style-type: none"> • application: one hole • showerhead type: handshower • handshower functions: one-function • handshower flow rate: 1.75 gpm (6.65 L/min) max. • spout reach: 9.75" • mounting kit: sold separately  		395	1717.85	Chrome	1	
		395BN	2319.15	Brushed Nickel	1	
		395BG	2319.15	Brushed Gold	1	
		395BL	2550.95	Matte Black	1	
FREESTANDING TUB FILLER VALVE AND MOUNTING KIT - PREMIUM						
 <ul style="list-style-type: none"> • description: single riser floor joist mounting kit • application: one hole • quarter turn stops: included 		TS50100	400.90	1/2" CC, NPT	2	
	 <ul style="list-style-type: none"> • description: single riser concrete mounting kit • application: one hole • connection size: 1/2" 		TS50110	325.95	1/2" CC, NPT	2
HOW TO ORDER VALVES: PAGE 463		 TRIM PART #	+	 VALVE PART #	=	 COMPLETE FAUCET

ONE-HANDLE WALLMOUNT TUB FILLER TRIM						
 <ul style="list-style-type: none"> • application: two hole • connection: 1/2" slip fit • tub spout type: non diverter • spout reach: 10.00" • includes: high flow volume control cartridge • WMV130 series valve kit: sold separately  		WT391	720.25	Chrome	3	
		WT391BN	965.15	Brushed Nickel	3	
		WT391BG	965.15	Brushed Gold	3	
		WT391BL	1061.60	Matte Black	3	
ONE-HANDLE WALLMOUNT TUB FILLER VALVE KIT						
 <ul style="list-style-type: none"> • application: two hole with adj. center dimensions • ports: three • quarter turn stops: included • includes: test plug • includes: spout manifold 		WMV130CIS	151.05	1/2" CC/IPS	6	
		WMV130XS	151.05	1/2" Crimp Ring PEX	6	
		WMV130CXS	151.05	1/2" Cold Exp. PEX	6	
HOW TO ORDER VALVES: PAGE 463		 TRIM PART #	+	 VALVE PART #	=	 COMPLETE FAUCET



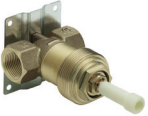

















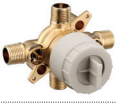

ALIGN® Collection

	MODEL	LIST	FINISH/CONNECT	CASE QTY	
TWO-HANDLE ROMAN TUB TRIM					
 <ul style="list-style-type: none"> • application: three hole • spout reach: 7.90" • valve: sold separately 	T393	523.85	Chrome	3	
	T393BN	731.95	Brushed Nickel	3	
	T393BG	731.95	Brushed Gold	3	
	T393BL	775.70	Matte Black	3	
TWO-HANDLE ROMAN TUB TRIM WITH HANDSHOWER					
 <ul style="list-style-type: none"> • application: four hole • showerhead type: handshower • handshower flow rate: 1.75 gpm (6.65 L/min) max. • spray functions: one-function • spout reach: 7.90" • valve: sold separately 	T394	815.85	Chrome	3	
	T394BN	1343.10	Brushed Nickel	3	
	T394BG	1343.10	Brushed Gold	3	
TWO-HANDLE ROMAN TUB VALVE					
 <ul style="list-style-type: none"> • deck thickness: 1/8" to 3-3/8" rough-in deck • adjustable spout shank: adjustable center dimensions 	4792	188.55	1/2" CC	6	
 <ul style="list-style-type: none"> • deck thickness: 1/8" to 2-3/4" rough-in deck • adjustable spout shank: 10" - 24" center dimensions 	4793	213.55	1/2" CPVC, Crimp Ring PEX	6	
	4794	203.60	1/2" Crimp Ring PEX, Cold Exp. PEX	6	
 <ul style="list-style-type: none"> • deck thickness: 1/8" to 3-3/16" rough-in deck • Non-adjustable spout shank: 10" center dimensions 	4796	177.65	1/2" CC	6	
	4797	181.10	1/2" CPVC, Crimp Ring PEX	6	
	4798	181.10	1/2" Crimp Ring PEX, Cold Exp. PEX	6	
TWO-HANDLE ROMAN TUB VALVE WITH HANDSHOWER					
 <ul style="list-style-type: none"> • deck thickness: 1/8" to 2-5/8" rough-in deck • non-adj spout shank: adjustable center dim's 	9792	424.85	1/2" CC	6	
 <ul style="list-style-type: none"> • deck thickness: 1/8" to 2-5/8" rough-in deck • adj spout shank: 10" - 24" center dimensions 	9793	434.80	1/2" CPVC, Crimp Ring PEX	6	
For more product details, reference page 464 in valve section.					
HOW TO ORDER VALVES: PAGE 464	 TRIM PART #	+	 VALVE PART #	=	 COMPLETE FAUCET





















		MODEL	LIST	FINISH/CONNECT	CASE QTY	
EXACTTEMP® VALVE ONLY TRIM						
 <ul style="list-style-type: none"> • description: temperature control valve trim • requires: separate volume control valve • valve: sold separately  		T4291	303.55	Chrome	3	
		T4291BN	458.40	Brushed Nickel	3	
		T4291BG	458.40	Brushed Gold	3	
		T4291BL	493.25	Matte Black	3	
EXACTTEMP® THERMOSTATIC MIXING SHOWER VALVE - PREMIUM						
 <ul style="list-style-type: none"> • description: thermostatic rough-in valve • ports: four with adjustable temp. limit stops • check stops: included 		S3371	714.65	¾" IPS	6	
HOW TO ORDER		 TRIM PART #	+	 VALVE PART #	=	 COMPLETE FAUCET
VALVES: PAGE 465						

EXACTTEMP® VOLUME CONTROL VALVE TRIM						
 <ul style="list-style-type: none"> • valve: sold separately  		T4292	154.50	Chrome	6	
		T4292BN	232.90	Brushed Nickel	6	
		T4292BG	232.90	Brushed Gold	6	
		T4292BL	251.15	Matte Black	6	
EXACTTEMP® VOLUME CONTROL SHOWER VALVE - PREMIUM						
 <ul style="list-style-type: none"> • includes: volume control 		S3600	181.70	¾" IPS	12	
HOW TO ORDER		 TRIM PART #	+	 VALVE PART #	=	 COMPLETE FAUCET
VALVES: PAGE 465						











ALIGN® Collection











		MODEL	LIST	FINISH/CONNECT	CASE QTY
M-CORE® 4-SERIES TUB/SHOWER TRIM					
	<ul style="list-style-type: none"> • showerhead: single-function eco-performance rainshower • showerhead size: 7" diameter • tub spout length: 7" • tub spout connection type: slip fit • tub spout type: diverter • includes: thermostatic cartridge with volume and temperature control • valve: sold separately 	 1.75 GPM (6.65 L/min) max.			
		UT4293EP	643.35	Chrome	4
		UT4293EPBN	982.10	Brushed Nickel	4
		UT4293EPBG	982.10	Brushed Gold	4
		UT4293EPBL	1066.80	Matte Black	4
M-CORE® 4-SERIES SHOWER ONLY TRIM					
	<ul style="list-style-type: none"> • showerhead: single-function eco-performance • showerhead size: 7" diameter • includes: thermostatic cartridge with volume and temperature control • valve: sold separately 	 1.75 GPM (6.65 L/min) max.			
		UT4292EP	549.15	Chrome	4
		UT4292EPBN	831.00	Brushed Nickel	4
		UT4292EPBG	831.00	Brushed Gold	4
		UT4292EPBL	900.60	Matte Black	4
M-CORE® 4-SERIES VALVE ONLY TRIM					
	<ul style="list-style-type: none"> • includes: thermostatic cartridge with volume and temperature control • valve: sold separately 	UT4291	483.05	Chrome	3
		UT4291BN	706.30	Brushed Nickel	3
		UT4291BG	706.30	Brushed Gold	3
		UT4291BL	763.40	Matte Black	3
		M-CORE® MIXING SHOWER VALVE			
	<ul style="list-style-type: none"> • tub/shower or shower only application • ports: four with adj. temp. limit stops • included: test plug and cross flow plug 	U140CI	71.20	1/2" CC/IPS	6
		U140X	71.20	1/2" Crimp Ring PEX + CC/IPS Tub	6
		U140CX	71.20	1/2" Cold Exp. PEX + CC/IPS Tub	6
		U140V	87.20	1/2" CPVC + CC/IPS Tub	6
			<ul style="list-style-type: none"> • tub/shower or shower only application • ports: four with adj. temp. limit stops • quarter turn stops: included 	U140CIS	102.45
U140XS	102.45			1/2" Crimp Ring PEX + CC/IPS Tub	6
U140CXS	102.45			1/2" Cold Exp. PEX + CC/IPS Tub	6
U140VS	118.50			1/2" CPVC + CC/IPS Tub	6
	<ul style="list-style-type: none"> • tub/shower only application • ports: four with adj. temp. limit stops • tub outlet: pre-fabricated 1/2" copper tube • included: quarter turn stops and plugs 			U140X-PF	80.40
		U140CX-PF	80.40	1/2" Cold Exp. PEX	6
	<ul style="list-style-type: none"> • tub/shower only application • ports: four with adj. temp. limit stops • tub outlet: pre-fabricated 1/2" copper tube • included: quarter turn stops and plugs 	U140XS-PF	111.70	1/2" Crimp Ring PEX	6
		U140CXS-PF	111.70	1/2" Cold Exp. PEX	6
	<ul style="list-style-type: none"> • shower only application • ports: three 	U130CI	71.20	1/2" CC/IPS	6
		U130X	71.20	1/2" Crimp Ring PEX	6
		U130CX	71.20	1/2" Cold Exp. PEX	6
	<ul style="list-style-type: none"> • shower only application • ports: three • quarter turn stops: included 	U130CIS	102.45	1/2" CC/IPS	6
		U130XS	102.45	1/2" Crimp Ring PEX	6
		U130CXS	102.45	1/2" Cold Exp. PEX	6
<p>Four port valves can be used with either Tub/Shower or Shower Only applications. Three port valves can ONLY be used with Shower Only applications. For more product details, reference pages 465-466 in valve section.</p>					
<p>HOW TO ORDER VALVES: PAGES 465-466</p>		 TRIM PART # +  VALVE PART # =  COMPLETE FAUCET			









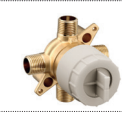

ALIGN®

		MODEL	LIST	FINISH/CONNECT	CASE QTY	
M-CORE® 3-SERIES TUB/SHOWER TRIM						
 <ul style="list-style-type: none"> • showerhead: single-function rainshower • showerhead size: 6-3/4" diameter • tub spout length: 7 3/8" • tub spout connection type: slip fit • tub spout type: diverter • includes: pressure balanced cartridge with volume and temperature control • valve: sold separately 	<ul style="list-style-type: none"> • 2.5 GPM (9.5 L/min) max. 	UT3293	508.35	Chrome	4	
	UT3293BN	847.10	Brushed Nickel	4		
	UT3293BG	847.10	Brushed Gold	4		
	UT3293BL	931.80	Matte Black	4		
	<ul style="list-style-type: none"> • 1.75 GPM (6.65 L/min) max. 	UT3293EP	508.35	Chrome	4	
	UT3293EPBN	847.10	Brushed Nickel	4		
	UT3293EPBG	847.10	Brushed Gold	4		
	UT3293EPBL	931.80	Matte Black	4		
	M-CORE® 3-SERIES SHOWER ONLY TRIM					
	 <ul style="list-style-type: none"> • showerhead: single-function rainshower • showerhead size: 6-3/4" diameter • includes: pressure balanced cartridge with volume and temperature control • valve: sold separately 	<ul style="list-style-type: none"> • 2.5 GPM (9.5 L/min) max. 	UT3292	414.15	Chrome	4
UT3292BN		696.00	Brushed Nickel	4		
UT3292BG		696.00	Brushed Gold	4		
UT3292BL		765.60	Matte Black	4		
<ul style="list-style-type: none"> • 1.75 GPM (6.65 L/min) max. 		UT3292EP	414.15	Chrome	4	
UT3292EPBN		696.00	Brushed Nickel	4		
UT3292EPBG		696.00	Brushed Gold	4		
UT3292EPBL		765.60	Matte Black	4		
M-CORE® 3-SERIES VALVE ONLY TRIM						
 <ul style="list-style-type: none"> • includes: pressure balanced cartridge with volume and temperature control • valve: sold separately 		UT3291	348.05	Chrome	3	
	UT3291BN	571.30	Brushed Nickel	3		
	UT3291BG	571.30	Brushed Gold	3		
	UT3291BL	628.40	Matte Black	3		
	M-CORE® MIXING SHOWER VALVE					
 <ul style="list-style-type: none"> • tub/shower or shower only application • ports: four with adj. temp. limit stops • included: test plug and cross flow plug 	U140CI	71.20	1/2" CC/IPS	6		
	U140X	71.20	1/2" Crimp Ring PEX + CC/IPS Tub	6		
	U140CX	71.20	1/2" Cold Exp. PEX + CC/IPS Tub	6		
	U140V	87.20	1/2" CPVC + CC/IPS Tub	6		
	 <ul style="list-style-type: none"> • tub/shower or shower only application • ports: four with adj. temp. limit stops • quarter turn stops: included 	U140CIS	102.45	1/2" CC/IPS	6	
U140XS		102.45	1/2" Crimp Ring PEX + CC/IPS Tub	6		
U140CXS		102.45	1/2" Cold Exp. PEX + CC/IPS Tub	6		
U140VS		118.50	1/2" CPVC + CC/IPS Tub	6		
 <ul style="list-style-type: none"> • tub/shower only application • ports: four with adj. temp. limit stops • tub outlet: pre-fabricated 1/2" copper tube • included: quarter turn stops and plugs 		U140X-PF	80.40	1/2" Crimp Ring PEX	6	
	U140CX-PF	80.40	1/2" Cold Exp. PEX	6		
 <ul style="list-style-type: none"> • tub/shower only application • ports: four with adj. temp. limit stops • tub outlet: pre-fabricated 1/2" copper tube • included: quarter turn stops and plugs 	U140XS-PF	111.70	1/2" Crimp Ring PEX	6		
	U140CXS-PF	111.70	1/2" Cold Exp. PEX	6		
 <ul style="list-style-type: none"> • shower only application • ports: three 	U130CI	71.20	1/2" CC/IPS	6		
	U130X	71.20	1/2" Crimp Ring PEX	6		
	U130CX	71.20	1/2" Cold Exp. PEX	6		
 <ul style="list-style-type: none"> • shower only application • ports: three • quarter turn stops: included 	U130CIS	102.45	1/2" CC/IPS	6		
	U130XS	102.45	1/2" Crimp Ring PEX	6		
	U130CXS	102.45	1/2" Cold Exp. PEX	6		
<p>Four port valves can be used with either Tub/Shower or Shower Only applications. Three port valves can ONLY be used with Shower Only applications. For more product details, reference pages 465-466 in valve section.</p>						
<p>HOW TO ORDER VALVES: PAGES 465-466</p>	 <p>TRIM PART #</p>	+	 <p>VALVE PART #</p>	=	 <p>COMPLETE FAUCET</p>	

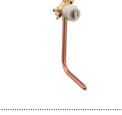

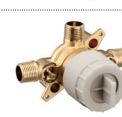



















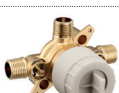

















		MODEL	LIST	FINISH/CONNECT	CASE QTY			
M-CORE® 3-SERIES WITH INTEGRATED TRANSFER VALVE TRIM								
 <ul style="list-style-type: none"> • includes: pressure balanced cartridge with volume and temperature control • valve: sold separately  		UT3290	328.90	Chrome	4			
		UT3290BN	407.75	Brushed Nickel	4			
		UT3290BG	407.75	Brushed Gold	4			
		UT3290BL	448.55	Matte Black	4			
M-CORE® WITH INTEGRATED TRANSFER VALVE								
Three Function (2 independent/1 shared) OR Six Function (3 independent/3 shared) - plumbing configuration page 472								
 <ul style="list-style-type: none"> • ports: four with adj. temp. limit stops • check stops: included 		U362CIS	265.40	1/2" CC/IPS	6			
		U362CXS	265.40	1/2" Cold Exp. PEX	6			
		U362XS	265.40	1/2" Crimp Ring PEX	6			
Two Independent Functions OR Three Independent Functions - plumbing configurations page 472								
 <ul style="list-style-type: none"> • ports: four with adj. temp. limit stops • check stops: included 		U232CIS	265.40	1/2" CC/IPS	6			
		U232CXS	265.40	1/2" Cold Exp. PEX	6			
		U232XS	265.40	1/2" Crimp Ring PEX	6			
For more product details, reference page 466 in valve section. See page 472 for plumbing configurations.								
HOW TO ORDER VALVES: PAGE 466		TRIM PART #	+		VALVE PART #	=		COMPLETE FAUCET

M-CORE® TRANSFER VALVE TRIM								
 <ul style="list-style-type: none"> • use with the M-CORE® transfer valve • valve: sold separately  		UT4191	227.70	Chrome	12			
		UT4191BN	280.30	Brushed Nickel	12			
		UT4191BG	280.30	Brushed Gold	12			
		UT4191BL	300.80	Matte Black	12			
M-CORE® TRANSFER VALVE								
Three Function (2 independent/1 shared) OR Six Function (3 independent/3 shared) - plumbing configuration page 472								
 <ul style="list-style-type: none"> • number of functions: three or six • ports: four 		U361CI	149.70	1/2" CC/IPS	6			
		U361CX	149.70	1/2" Cold Exp. PEX	6			
		U361X	149.70	1/2" Crimp Ring PEX	6			
Two Independent Functions OR Three Independent Functions - plumbing configurations page 472								
 <ul style="list-style-type: none"> • number of functions: two or three • ports: four 		U231CI	149.70	1/2" CC/IPS	6			
		U231CX	149.70	1/2" Cold Exp. PEX	6			
		U231X	149.70	1/2" Crimp Ring PEX	6			
For more product details, reference page 466 in valve section. See page 472 for plumbing configurations.								
HOW TO ORDER VALVES: PAGE 466		TRIM PART #	+		VALVE PART #	=		COMPLETE FAUCET

		MODEL	LIST	FINISH/CONNECT	CASE QTY	
M-CORE® 2-SERIES TUB/SHOWER TRIM						
 <ul style="list-style-type: none"> • showerhead: single-function eco-performance • showerhead size: 3-5/8" diameter • tub spout length: 7 3/8" • tub spout connection type: slip fit • tub spout type: diverter • red/blue markings: included • includes: pressure balanced cartridge with temperature control • valve: sold separately 	<ul style="list-style-type: none"> • showerhead type: showerhead sold separately • tub spout length: 7 3/8" • tub spout connection type: slip fit • tub spout type: diverter • red/blue markings: included • includes: pressure balanced cartridge with temperature control • valve: sold separately 	1.75 GPM (6.65 L/min) max.				
		UT2193EP	409.10	Chrome	3	
		UT2193EPBN	640.40	Brushed Nickel	3	
		UT2193EPBG	640.40	Brushed Gold	3	
UT2193EPBL	691.75	Matte Black	3			
M-CORE® 2-SERIES SHOWER ONLY TRIM						
 <ul style="list-style-type: none"> • showerhead: single-function eco-performance • showerhead size: 3-5/8" diameter • red/blue markings: included • includes: pressure balanced cartridge with temperature control • valve: sold separately 	<ul style="list-style-type: none"> • showerhead type: showerhead sold separately • red/blue markings: included • includes: pressure balanced cartridge with temperature control • valve: sold separately 	1.75 GPM (6.65 L/min) max.				
		UT2192EP	348.50	Chrome	12	
		UT2192EPBN	530.65	Brushed Nickel	12	
		UT2192EPBG	530.65	Brushed Gold	12	
UT2192EPBL	571.15	Matte Black	12			
 <ul style="list-style-type: none"> • showerhead type: showerhead sold separately • red/blue markings: included • includes: pressure balanced cartridge with temperature control • valve: sold separately 	<ul style="list-style-type: none"> • showerhead type: showerhead sold separately • red/blue markings: included • includes: pressure balanced cartridge with temperature control • valve: sold separately 	UT2192NH	303.00	Chrome	3	
		UT2192NHBN	447.45	Brushed Nickel	3	
		UT2192NHBG	447.45	Brushed Gold	3	
		UT2192NHBL	479.65	Matte Black	3	
M-CORE® MIXING SHOWER VALVE						
 <ul style="list-style-type: none"> • tub/shower or shower only application • ports: four with adj. temp. limit stops • included: test plug and cross flow plug 	<ul style="list-style-type: none"> • tub/shower or shower only application • ports: four with adj. temp. limit stops • quarter turn stops: included 	U140CI	71.20	1/2" CC/IPS	6	
		U140X	71.20	1/2" Crimp Ring PEX + CC/IPS Tub	6	
		U140CX	71.20	1/2" Cold Exp. PEX + CC/IPS Tub	6	
		U140V	87.20	1/2" CPVC + CC/IPS Tub	6	
 <ul style="list-style-type: none"> • tub/shower or shower only application • ports: four with adj. temp. limit stops • quarter turn stops: included 	<ul style="list-style-type: none"> • tub/shower only application • ports: four with adj. temp. limit stops • tub outlet: pre-fabricated 1/2" copper tube • included: quarter turn stops and plugs 	U140CIS	102.45	1/2" CC/IPS	6	
		U140XS	102.45	1/2" Crimp Ring PEX + CC/IPS Tub	6	
		U140CXS	102.45	1/2" Cold Exp. PEX + CC/IPS Tub	6	
		U140VS	118.50	1/2" CPVC + CC/IPS Tub	6	
 <ul style="list-style-type: none"> • tub/shower only application • ports: four with adj. temp. limit stops • tub outlet: pre-fabricated 1/2" copper tube • included: quarter turn stops and plugs 	<ul style="list-style-type: none"> • tub/shower only application • ports: four with adj. temp. limit stops • tub outlet: pre-fabricated 1/2" copper tube • included: quarter turn stops and plugs 	U140X-PF	80.40	1/2" Crimp Ring PEX	6	
		U140CX-PF	80.40	1/2" Cold Exp. PEX	6	
 <ul style="list-style-type: none"> • shower only application • ports: three 	<ul style="list-style-type: none"> • shower only application • ports: three • quarter turn stops: included 	U140XS-PF	111.70	1/2" Crimp Ring PEX	6	
		U140CXS-PF	111.70	1/2" Cold Exp. PEX	6	
		U130CI	71.20	1/2" CC/IPS	6	
 <ul style="list-style-type: none"> • shower only application • ports: three • quarter turn stops: included 	<ul style="list-style-type: none"> • shower only application • ports: three • quarter turn stops: included 	U130X	71.20	1/2" Crimp Ring PEX	6	
		U130CX	71.20	1/2" Cold Exp. PEX	6	
		U130CIS	102.45	1/2" CC/IPS	6	
 <ul style="list-style-type: none"> • shower only application • ports: three • quarter turn stops: included 	<ul style="list-style-type: none"> • shower only application • ports: three • quarter turn stops: included 	U130XS	102.45	1/2" Crimp Ring PEX	6	
		U130CXS	102.45	1/2" Cold Exp. PEX	6	
<p>Four port valves can be used with either Tub/Shower or Shower Only applications. Three port valves can ONLY be used with Shower Only applications. For more product details, reference pages 465-466 in valve section.</p>						
<p>HOW TO ORDER VALVES: PAGES 465-466</p>		 <p>TRIM PART #</p>	+	 <p>VALVE PART #</p>	=	 <p>COMPLETE FAUCET</p>















ALIGN® Collection

		MODEL	LIST	FINISH/CONNECT	CASE QTY	
M-CORE® 2-SERIES VALVE ONLY TRIM						
 <ul style="list-style-type: none"> • red/blue markings: included • includes: pressure balanced cartridge with temperature control • valve: sold separately 		UT2191	293.05	Chrome	3	
		UT2191BN	429.15	Brushed Nickel	3	
		UT2191BG	429.15	Brushed Gold	3	
		UT2191BL	459.55	Matte Black	3	
M-CORE® MIXING SHOWER VALVE						
 <ul style="list-style-type: none"> • tub/shower or shower only application • ports: four with adj. temp. limit stops • included: test plug and cross flow plug 		U140CI	71.20	1/2" CC/IPS	6	
		U140X	71.20	1/2" Crimp Ring PEX + CC/IPS Tub	6	
		U140CX	71.20	1/2" Cold Exp. PEX + CC/IPS Tub	6	
		U140V	87.20	1/2" CPVC + CC/IPS Tub	6	
 <ul style="list-style-type: none"> • tub/shower or shower only application • ports: four with adj. temp. limit stops • quarter turn stops: included 		U140CIS	102.45	1/2" CC/IPS	6	
		U140XS	102.45	1/2" Crimp Ring PEX + CC/IPS Tub	6	
		U140CXS	102.45	1/2" Cold Exp. PEX + CC/IPS Tub	6	
		U140VS	118.50	1/2" CPVC + CC/IPS Tub	6	
 <ul style="list-style-type: none"> • tub/shower only application • ports: four with adj. temp. limit stops • tub outlet: pre-fabricated 1/2" copper tube • included: quarter turn stops and plugs 		U140X-PF	80.40	1/2" Crimp Ring PEX	6	
		U140CX-PF	80.40	1/2" Cold Exp. PEX	6	
 <ul style="list-style-type: none"> • tub/shower only application • ports: four with adj. temp. limit stops • tub outlet: pre-fabricated 1/2" copper tube • included: quarter turn stops and plugs 		U140XS-PF	111.70	1/2" Crimp Ring PEX	6	
		U140CXS-PF	111.70	1/2" Cold Exp. PEX	6	
 <ul style="list-style-type: none"> • shower only application • ports: three 		U130CI	71.20	1/2" CC/IPS	6	
		U130X	71.20	1/2" Crimp Ring PEX	6	
		U130CX	71.20	1/2" Cold Exp. PEX	6	
 <ul style="list-style-type: none"> • shower only application • ports: three • quarter turn stops: included 		U130CIS	102.45	1/2" CC/IPS	6	
		U130XS	102.45	1/2" Crimp Ring PEX	6	
		U130CXS	102.45	1/2" Cold Exp. PEX	6	
<p>Four port valves can be used with either Tub/Shower or Shower Only applications. Three port valves can ONLY be used with Shower Only applications. For more product details, reference pages 465-466 in valve section.</p>						
<p>HOW TO ORDER VALVES: PAGES 465-466</p>		 <p>TRIM PART #</p>	+	 <p>VALVE PART #</p>	=	 <p>COMPLETE FAUCET</p>

		MODEL	LIST	FINISH/CONNECT	CASE QTY	
POSI-TEMP® TUB/SHOWER TRIM						
 <ul style="list-style-type: none"> • showerhead: single-function standard • showerhead size: 3-5/8" diameter • tub spout length: 7 3/8" • tub spout connection type: slip fit • tub spout type: diverter • red/blue markings: included • valve: sold separately 		2.5 GPM (9.5 L/min) max.				
		T2193	283.05	Chrome	3	
		T2193BN	514.25	Brushed Nickel	3	
		T2193BG	514.25	Brushed Gold	3	
		T2193BL	565.60	Matte Black	3	
		1.75 GPM (6.65 L/min) max.				
		T2193EP	283.05	Chrome	3	
		T2193EPBN	514.25	Brushed Nickel	3	
		T2193EPBG	514.25	Brushed Gold	3	
		T2193EPBL	565.60	Matte Black	3	
 <ul style="list-style-type: none"> • showerhead type: showerhead sold separately • tub spout length: 7 3/8" • tub spout connection type: slip fit • tub spout type: diverter • red/blue markings: included • valve: sold separately 		T2193NH	190.60	Chrome	3	
		T2193NHBN	372.60	Brushed Nickel	3	
		T2193NHBG	372.60	Brushed Gold	3	
		T2193NHBL	409.95	Matte Black	3	
POSI-TEMP® SHOWER ONLY TRIM						
 <ul style="list-style-type: none"> • showerhead: single-function standard • showerhead size: 3-5/8" diameter • red/blue markings: included • valve: sold separately 		2.5 GPM (9.5 L/min) max.				
		T2192	222.40	Chrome	3	
		T2192BN	404.50	Brushed Nickel	3	
		T2192BG	404.50	Brushed Gold	3	
		T2192BL	445.05	Matte Black	3	
		1.75 GPM (6.65 L/min) max.				
		T2192EP	222.40	Chrome	3	
		T2192EPBN	404.50	Brushed Nickel	3	
		T2192EPBG	404.50	Brushed Gold	3	
		T2192EPBL	445.05	Matte Black	3	
 <ul style="list-style-type: none"> • showerhead type: showerhead sold separately • red/blue markings: included • valve: sold separately 		T2192NH	176.95	Chrome	3	
		T2192NHBN	321.35	Brushed Nickel	3	
		T2192NHBG	321.35	Brushed Gold	3	
		T2192NHBL	353.50	Matte Black	3	
POSI-TEMP® VALVE ONLY TRIM						
 <ul style="list-style-type: none"> • red/blue markings: included • valve: sold separately 		T2191	166.90	Chrome	3	
		T2191BN	303.00	Brushed Nickel	3	
		T2191BG	303.00	Brushed Gold	3	
		T2191BL	333.40	Matte Black	3	
POSI-TEMP® SHOWER MIXING VALVES						
 <ul style="list-style-type: none"> • tub/shower or shower only application • ports: four with adjustable temp. limit stops • test plug: included 		2520 ◆	156.10	1/2" CC	6	
		2510 ◆	156.10	1/2" IPS	6	
 <ul style="list-style-type: none"> • tub/shower or shower only application • ports: four with adjustable temp. limit stops • quarter turn stops: included • test plug: included 		2570 ◆	189.55	1/2" CC	6	
		2590 ◆	189.55	1/2" IPS	6	
		2580 ◆	156.10	1/2" Crimp ring PEX	6	
 <ul style="list-style-type: none"> • tub/shower only application • ports: four with adjustable temp. limit stops • quarter turn stops: included • test plug: included 		2360PF	208.45	1/2" Crimp Ring PEX	3	
		2385PF	208.45	1/2" Cold Exp. PEX	3	
 <ul style="list-style-type: none"> • shower only application • ports: three with adjustable temp. limit stops • quarter turn stops: included • test plug: included 		2326PF	201.20	1/2" Crimp Ring PEX	6	
		2328PF	201.20	1/2" Cold Exp. PEX	6	
<p>Four port valves can be used with either Tub/Shower or Shower Only applications. Three port valves can ONLY be used with Shower Only applications. For more product details, reference page 467-468 in valve section.</p>						
<p>HOW TO ORDER VALVES: PAGES 467-470</p>		 <p>TRIM PART #</p>	+	 <p>VALVE PART #</p>	=	 <p>COMPLETE FAUCET</p>



ALIGN® Collection

		MODEL	LIST	FINISH/CONNECT	CASE QTY
POSI-TEMP® WITH INTEGRATED TRANSFER VALVE TRIM					
 <ul style="list-style-type: none"> • red/blue markings: included • valve: sold separately  		T2190	301.30	Chrome	4
		T2190BN	547.05	Brushed Nickel	4
		T2190BG	547.05	Brushed Gold	4
		T2190BL	601.90	Matte Black	4
POSI-TEMP® WITH INTEGRATED TRANSFER VALVE					
 <ul style="list-style-type: none"> • functions: three (two independent and one shared) • ports: four with adjustable temp. limit stops • test plug: included 		2551	281.85	1/2" IPS	6
 <ul style="list-style-type: none"> • functions: three (two independent and one shared) • ports: four with adjustable temp. limit stops • stops: included • test plug: included 		2581	317.40	1/2" IPS	6
 <ul style="list-style-type: none"> • functions: two independent • ports: four with adjustable temp. limit stops • test plug: included 		2521	281.85	1/2" IPS	6
 <ul style="list-style-type: none"> • functions: two independent • ports: four with adjustable temp. limit stops • stops: included • test plug: included 		2571	317.40	1/2" IPS	6
For more product details, reference page 471 in valve section.					
HOW TO ORDER VALVES: PAGE 471	 TRIM PART #	+	 VALVE PART #	=	 COMPLETE FAUCET

Moen® bath accessories CANNOT be combined with Moen faucet parts on a Purchase Order.

A PERFECT MATCH

A line of perfectly matching accessories - including tank levers and towel bars - allow for a completely cohesive look in the bath.

MODEL NUMBER	LIST EACH	DESCRIPTION	QTY
Chrome (CH)			
YB0402CH	65.55	Swiveling Double Robe Hook	24
YB0403CH	36.25	Single Robe Hook	24
Ⓟ YB0408CH	66.15	Pivoting Paper Holder	6
YB0409CH	56.30	Single-Post Paper Holder	6
YB0418CH	76.80	18" Towel Bar	6
YB0424CH	79.20	24" Towel Bar	6
YB0486CH	53.90	Hand Towel Bar	6

Brushed Nickel (BN)			
YB0402BN	74.65	Swiveling Double Robe Hook	24
YB0403BN	39.90	Single Robe Hook	24
Ⓟ YB0408BN	73.15	Pivoting Paper Holder	6
YB0409BN	61.95	Single-Post Paper Holder	6
YB0418BN	84.45	18" Towel Bar	6
YB0424BN	87.45	24" Towel Bar	6
YB0486BN	58.95	Hand Towel Bar	6

Matte Black (BL)			
YB0402BL	81.90	Swiveling Double Robe Hook	24
YB0403BL	43.80	Single Robe Hook	24
Ⓟ YB0408BL	80.45	Pivoting Paper Holder	6
YB0409BL	68.10	Single-Post Paper Holder	6
YB0418BL	92.85	18" Towel Bar	6
YB0424BL	96.15	24" Towel Bar	6
YB0486BL	64.85	Hand Towel Bar	6

Brushed Gold (BG)			
YB0403BG	47.90	Single Robe Hook	24
Ⓟ YB0408BG	106.10	Pivoting Paper Holder	6
YB0418BG	118.25	18" Towel Bar	6
YB0424BG	122.30	24" Towel Bar	6
YB0486BG	85.45	Hand Towel Bar	6

Ⓟ Denotes pivoting paper holder

GRAB BARS

MODEL NUMBER	LIST EACH	DESCRIPTION	QTY
1½" • Chrome (CH)			
YG0412CH	128.75	12" Designer Grab Bar	6
YG0418CH	134.50	18" Designer Grab Bar	6
YG0424CH	140.50	24" Designer Grab Bar	6
YG0436CH	159.95	36" Designer Grab Bar	6
YG0442CH	234.70	42" Designer Grab Bar	6
1½" • Brushed Gold (BG)			
YG0418BG	195.75	18" Designer Grab Bar	6
YG0424BG	211.20	24" Designer Grab Bar	6
1½" • Brushed Nickel (BN)			
YG0412BN	155.65	12" Designer Grab Bar	6
YG0418BN	163.15	18" Designer Grab Bar	6
YG0424BN	176.05	24" Designer Grab Bar	6
YG0436BN	198.15	36" Designer Grab Bar	6
YG0442BN	293.40	42" Designer Grab Bar	6



Single Robe Hook
YB0403



Swiveling Double Robe Hook
YB0402



Pivoting Paper Holder
YB0408 | Ⓟ



Single Post Paper Holder
YB0409



Hand Towel Bar
YB0486



18" Towel Bar
YB0418



24" Towel Bar
YB0424

SECUREMOUNT™

- SecureMount™ Grab Bars are manufactured with an innovative flange design that makes it easy to connect to the stud at multiple points.
- Tested to withstand 500lbs.
- To install grab bars securely without studs, use SecureMount™ Anchors. Sold separately.





18" Designer Grab Bar
YG0418

Ⓟ Complies with Americans with Disabilities Act (ADA) specifications. SecureMount™ Grab Bars are tested to withstand 500 lb. pull when securely installed per instructions.

List price is per each (unless otherwise noted). Product can be ordered by case quantity or individually. For more information on ordering bath accessories, contact Moen Bath Accessory Customer Service at 800-882-0116, contact your local Moen sales representative, or visit us at www.moen.com.



RIZON® Collection

	MODEL	LIST	FINISH/CONNECT	CASE QTY
ONE-HANDLE BATHROOM FAUCET				
 	<ul style="list-style-type: none"> • application: one or three hole • supply lines: flexible • connection: 3/8" compression • deckplate: sold separately • drain assembly: metal with lift rod • red/blue markings: included 			
	<p>1.2 GPM (4.5L/min) max.</p> <p>6900 356.45 Chrome 3</p> <p>6900BL 516.90 Matte Black 3</p> <p style="text-align: center;">OPTIONAL DECKPLATE SOLD SEPARATELY</p> <p>165006 27.90 Chrome 20</p> <p>165006BL 57.60 Matte Black 20</p>			

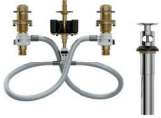













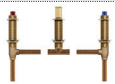

TWO-HANDLE WIDESPREAD BATHROOM FAUCET TRIM				
	<ul style="list-style-type: none"> • application: three hole • center dimensions: 8" - 16" center • drain assembly: metal with lift rod • red/blue markings: included • valve: sold separately 			
	<p>1.2 GPM (4.5L/min) max.</p> <p>T6920 370.20 Chrome 3</p> <p>T6920BL 610.80 Matte Black 3</p>			
WIDESPREAD FAUCET VALVE				
	<ul style="list-style-type: none"> • application: three hole • center dimensions: 8" - 16" center • drain assembly: metal with lift rod 	<p>9000◆</p>	<p>162.15</p> <p>1/2" IPS</p>	<p>6</p>

HOW TO ORDER
VALVES: PAGE 463















TRIM PART #

VALVE PART #



















COMPLETE FAUCET

	MODEL	LIST	FINISH/CONNECT	CASE QTY	
TWO-HANDLE ROMAN TUB TRIM					
 <ul style="list-style-type: none"> • application: three hole • spout reach: 7.75" • valve: sold separately 	T935	523.85	Chrome	3	
	T935BL	805.15	Matte Black	3	
TWO-HANDLE ROMAN TUB TRIM WITH HANDSHOWER					
 <ul style="list-style-type: none"> • application: four hole • showerhead type: handshower • handshower flow rate: 1.75 gpm (6.65 L/min) max. • spray functions: one-function • spout reach: 7.75" • valve: sold separately 	T936	815.85	Chrome	3	
TWO-HANDLE ROMAN TUB VALVE					
 <ul style="list-style-type: none"> • deck thickness: 1/8" to 3-3/8" rough-in deck • adjustable spout shank: adjustable center dimensions  DURALAST®	4792	188.55	1/2" CC	6	
 <ul style="list-style-type: none"> • deck thickness: 1/8" to 2-3/4" rough-in deck • adjustable spout shank: 10" - 24" center dimensions  DURALOCK® DURALAST®	4793	213.55	1/2" CPVC, Crimp Ring PEX	6	
	4794	203.60	1/2" Crimp Ring PEX, Cold Exp. PEX	6	
 <ul style="list-style-type: none"> • deck thickness: 1/8" to 3-3/16" rough-in deck • Non-adjustable spout shank: 10" center dimensions  DURALAST®	4796	177.65	1/2" CC	6	
	4797	181.10	1/2" CPVC, Crimp Ring PEX	6	
	4798	181.10	1/2" Crimp Ring PEX, Cold Exp. PEX	6	
TWO-HANDLE ROMAN TUB VALVE WITH HANDSHOWER					
 <ul style="list-style-type: none"> • deck thickness: 1/8" to 2-5/8" rough-in deck • non-adj spout shank: adjustable center dim's  DURALAST®	9792	424.85	1/2" CC	6	
 <ul style="list-style-type: none"> • deck thickness: 1/8" to 2-5/8" rough-in deck • adj spout shank: 10" - 24" center dimensions  DURALOCK® DURALAST®	9793	434.80	1/2" CPVC, Crimp Ring PEX	6	
For more product details, reference page 464 in valve section.					
HOW TO ORDER VALVES: PAGE 464	 TRIM PART #	+	 VALVE PART #	=	 COMPLETE FAUCET









RIZON® Collection



































		MODEL	LIST	FINISH/CONNECT	CASE QTY
M-CORE® 4-SERIES TUB/SHOWER TRIM					
	<ul style="list-style-type: none"> • showerhead type: eco-performance rainshower • showerhead size: 6-3/4" diameter • tub spout length: 7" • tub spout connection type: slip fit • tub spout type: diverter • includes: thermostatic cartridge with volume and temperature control • valve: sold separately 	1.75 GPM (6.65 L/min) max.			
		UT4813EP	643.35	Chrome	4
		UT4813EPBL	1051.70	Matte Black	4
					
M-CORE® 4-SERIES SHOWER ONLY TRIM					
	<ul style="list-style-type: none"> • showerhead type: eco-performance rainshower • showerhead size: 6-3/4" diameter • includes: thermostatic cartridge with volume and temperature control • valve: sold separately 	1.75 GPM (6.65 L/min) max.			
		UT4812EP	549.15	Chrome	4
		UT4812EPBL	885.55	Matte Black	4
					
M-CORE® 4-SERIES VALVE ONLY TRIM					
	<ul style="list-style-type: none"> • includes: thermostatic cartridge with volume and temperature control • valve: sold separately 	UT4811	483.05	Chrome	3
		UT4811BL	748.50	Matte Black	3
					
M-CORE® MIXING SHOWER VALVE					
	<ul style="list-style-type: none"> • tub/shower or shower only application • ports: four with adj. temp. limit stops • included: test plug and cross flow plug 	U140CI	71.20	1/2" CC/IPS	6
		U140X	71.20	1/2" Crimp Ring PEX + CC/IPS Tub	6
		U140CX	71.20	1/2" Cold Exp. PEX + CC/IPS Tub	6
		U140V	87.20	1/2" CPVC + CC/IPS Tub	6
	<ul style="list-style-type: none"> • tub/shower or shower only application • ports: four with adj. temp. limit stops • quarter turn stops: included 	U140CIS	102.45	1/2" CC/IPS	6
		U140XS	102.45	1/2" Crimp Ring PEX + CC/IPS Tub	6
		U140CXS	102.45	1/2" Cold Exp. PEX + CC/IPS Tub	6
		U140VS	118.50	1/2" CPVC + CC/IPS Tub	6
	<ul style="list-style-type: none"> • tub/shower only application • ports: four with adj. temp. limit stops • tub outlet: pre-fabricated 1/2" copper tube • included: quarter turn stops and plugs 	U140X-PF	80.40	1/2" Crimp Ring PEX	6
		U140CX-PF	80.40	1/2" Cold Exp. PEX	6
	<ul style="list-style-type: none"> • tub/shower only application • ports: four with adj. temp. limit stops • tub outlet: pre-fabricated 1/2" copper tube • included: quarter turn stops and plugs 	U140XS-PF	111.70	1/2" Crimp Ring PEX	6
		U140CXS-PF	111.70	1/2" Cold Exp. PEX	6
	<ul style="list-style-type: none"> • shower only application • ports: three 	U130CI	71.20	1/2" CC/IPS	6
		U130X	71.20	1/2" Crimp Ring PEX	6
		U130CX	71.20	1/2" Cold Exp. PEX	6
	<ul style="list-style-type: none"> • shower only application • ports: three • quarter turn stops: included 	U130CIS	102.45	1/2" CC/IPS	6
		U130XS	102.45	1/2" Crimp Ring PEX	6
		U130CXS	102.45	1/2" Cold Exp. PEX	6
<p>Four port valves can be used with either Tub/Shower or Shower Only applications. Three port valves can ONLY be used with Shower Only applications. For more product details, reference pages 465-466 in valve section.</p>					
HOW TO ORDER VALVES: PAGES 465-466					

RIZON®

		MODEL	LIST	FINISH/CONNECT	CASE QTY
M-CORE® 3-SERIES TUB/SHOWER TRIM					
	<ul style="list-style-type: none"> • showerhead type: eco-performance rainshower • showerhead size: 6-3/4" diameter • tub spout length: 7" • tub spout connection type: slip fit • tub spout type: diverter • includes: pressure balanced cartridge with volume and temperature control • valve: sold separately 	1.75 GPM (6.65 L/min) max.			
		UT3813EP	508.35	Chrome	4
		UT3813EPBL	916.70	Matte Black	4
					
M-CORE® 3-SERIES SHOWER ONLY TRIM					
	<ul style="list-style-type: none"> • showerhead type: eco-performance rainshower • showerhead size: 6-3/4" diameter • includes: pressure balanced cartridge with volume and temperature control • valve: sold separately 	1.75 GPM (6.65 L/min) max.			
		UT3812EP	414.15	Chrome	4
		UT3812EPBL	750.55	Matte Black	4
					
M-CORE® 3-SERIES VALVE ONLY TRIM					
	<ul style="list-style-type: none"> • includes: pressure balanced cartridge with volume and temperature control • valve: sold separately 	UT3811	348.05	Chrome	3
		UT3811BL	613.50	Matte Black	3
					
M-CORE® MIXING SHOWER VALVE					
	<ul style="list-style-type: none"> • tub/shower or shower only application • ports: four with adj. temp. limit stops • included: test plug and cross flow plug 	U140CI	71.20	1/2" CC/IPS	6
		U140X	71.20	1/2" Crimp Ring PEX + CC/IPS Tub	6
		U140CX	71.20	1/2" Cold Exp. PEX + CC/IPS Tub	6
		U140V	87.20	1/2" CPVC + CC/IPS Tub	6
	<ul style="list-style-type: none"> • tub/shower or shower only application • ports: four with adj. temp. limit stops • quarter turn stops: included 	U140CIS	102.45	1/2" CC/IPS	6
		U140XS	102.45	1/2" Crimp Ring PEX + CC/IPS Tub	6
		U140CXS	102.45	1/2" Cold Exp. PEX + CC/IPS Tub	6
		U140VS	118.50	1/2" CPVC + CC/IPS Tub	6
	<ul style="list-style-type: none"> • tub/shower only application • ports: four with adj. temp. limit stops • tub outlet: pre-fabricated 1/2" copper tube • included: quarter turn stops and plugs 	U140X-PF	80.40	1/2" Crimp Ring PEX	6
		U140CX-PF	80.40	1/2" Cold Exp. PEX	6
	<ul style="list-style-type: none"> • tub/shower only application • ports: four with adj. temp. limit stops • tub outlet: pre-fabricated 1/2" copper tube • included: quarter turn stops and plugs 	U140XS-PF	111.70	1/2" Crimp Ring PEX	6
		U140CXS-PF	111.70	1/2" Cold Exp. PEX	6
	<ul style="list-style-type: none"> • shower only application • ports: three 	U130CI	71.20	1/2" CC/IPS	6
		U130X	71.20	1/2" Crimp Ring PEX	6
		U130CX	71.20	1/2" Cold Exp. PEX	6
	<ul style="list-style-type: none"> • shower only application • ports: three • quarter turn stops: included 	U130CIS	102.45	1/2" CC/IPS	6
		U130XS	102.45	1/2" Crimp Ring PEX	6
		U130CXS	102.45	1/2" Cold Exp. PEX	6
<p>Four port valves can be used with either Tub/Shower or Shower Only applications. Three port valves can ONLY be used with Shower Only applications. For more product details, reference pages 465-466 in valve section.</p>					
HOW TO ORDER VALVES: PAGES 465-466		 TRIM PART #   VALVE PART #   COMPLETE FAUCET			

RIZON® Collection

		MODEL	LIST	FINISH/CONNECT	CASE QTY			
M-CORE® TRANSFER VALVE TRIM								
 <ul style="list-style-type: none"> • use with the M-CORE® transfer valve • valve: sold separately 		UT2081	227.70	Chrome	12			
		UT2081BL	300.85	Matte Black	12			
M-CORE® TRANSFER VALVE								
Three Function (2 independent/1 shared) OR Six Function (3 independent/3 shared) - plumbing configuration page 472								
 <ul style="list-style-type: none"> • number of functions: three or six • ports: four 		U361CI	149.70	1/2" CC/IPS	6			
		U361CX	149.70	1/2" Cold Exp. PEX	6			
		U361X	149.70	1/2" Crimp Ring PEX	6			
Two Independent Functions OR Three Independent Functions - plumbing configurations page 472								
 <ul style="list-style-type: none"> • number of functions: two or three • ports: four 		U231CI	149.70	1/2" CC/IPS	6			
		U231CX	149.70	1/2" Cold Exp. PEX	6			
		U231X	149.70	1/2" Crimp Ring PEX	6			
For more product details, reference page 466 in valve section. See page 472 for plumbing configurations.								
HOW TO ORDER VALVES: PAGE 466		TRIM PART #	+		VALVE PART #	=		COMPLETE FAUCET















		MODEL	LIST	FINISH/CONNECT	CASE QTY
M-CORE® 2-SERIES TUB/SHOWER TRIM					
  	<ul style="list-style-type: none"> • showerhead: single-function eco-performance • showerhead size: 3.75" diameter • tub spout length: 7" • tub spout connection type: slip fit • tub spout type: diverter • red/blue markings: included • includes: pressure balanced cartridge with temperature control • valve: sold separately  	1.75 GPM (6.65 L/min) max.			
		UT2813EP	409.10	Chrome	12
		UT2813EPBL	691.75	Matte Black	12
  	<ul style="list-style-type: none"> • showerhead type: showerhead sold separately • tub spout length: 7" • tub spout connection type: slip fit • tub spout type: diverter • red/blue markings: included • includes: pressure balanced cartridge with temperature control • valve: sold separately  	UT2813NH	316.75	Chrome	3
		UT2813NHBL	536.00	Matte Black	3
M-CORE® 2-SERIES SHOWER ONLY TRIM					
 	<ul style="list-style-type: none"> • showerhead: single-function eco-performance • showerhead size: 3.75" diameter • red/blue markings: included • includes: pressure balanced cartridge with temperature control • valve: sold separately  	1.75 GPM (6.65 L/min) max.			
		UT2812EP	348.50	Chrome	12
		UT2812EPBL	571.10	Matte Black	12
 	<ul style="list-style-type: none"> • showerhead type: showerhead sold separately • red/blue markings: included • includes: pressure balanced cartridge with temperature control • valve: sold separately  	UT2812NH	303.00	Chrome	3
		UT2812NHBL	479.65	Matte Black	3
M-CORE® MIXING SHOWER VALVE					
	<ul style="list-style-type: none"> • tub/shower or shower only application • ports: four with adj. temp. limit stops • included: test plug and cross flow plug 	U140CI	71.20	1/2" CC/IPS	6
		U140X	71.20	1/2" Crimp Ring PEX + CC/IPS Tub	6
		U140CX	71.20	1/2" Cold Exp. PEX + CC/IPS Tub	6
		U140V	87.20	1/2" CPVC + CC/IPS Tub	6
	<ul style="list-style-type: none"> • tub/shower or shower only application • ports: four with adj. temp. limit stops • quarter turn stops: included 	U140CIS	102.45	1/2" CC/IPS	6
		U140XS	102.45	1/2" Crimp Ring PEX + CC/IPS Tub	6
		U140XS	102.45	1/2" Cold Exp. PEX + CC/IPS Tub	6
		U140VS	118.50	1/2" CPVC + CC/IPS Tub	6
	<ul style="list-style-type: none"> • tub/shower only application • ports: four with adj. temp. limit stops • tub outlet: pre-fabricated 1/2" copper tube • included: quarter turn stops and plugs 	U140X-PF	80.40	1/2" Crimp Ring PEX	6
		U140CX-PF	80.40	1/2" Cold Exp. PEX	6
	<ul style="list-style-type: none"> • tub/shower only application • ports: four with adj. temp. limit stops • tub outlet: pre-fabricated 1/2" copper tube • included: quarter turn stops and plugs 	U140XS-PF	111.70	1/2" Crimp Ring PEX	6
		U140CXS-PF	111.70	1/2" Cold Exp. PEX	6
	<ul style="list-style-type: none"> • shower only application • ports: three 	U130CI	71.20	1/2" CC/IPS	6
		U130X	71.20	1/2" Crimp Ring PEX	6
		U130CX	71.20	1/2" Cold Exp. PEX	6
	<ul style="list-style-type: none"> • shower only application • ports: three • quarter turn stops: included 	U130CIS	102.45	1/2" CC/IPS	6
		U130XS	102.45	1/2" Crimp Ring PEX	6
		U130CXS	102.45	1/2" Cold Exp. PEX	6
<p>Four port valves can be used with either Tub/Shower or Shower Only applications. Three port valves can ONLY be used with Shower Only applications. For more product details, reference pages 465-466 in valve section.</p>					
HOW TO ORDER VALVES: PAGES 465-466	 TRIM PART #		 VALVE PART #		 COMPLETE FAUCET



RIZON® Collection

		MODEL	LIST	FINISH/CONNECT	CASE QTY	
POSI-TEMP® TUB/SHOWER TRIM						
<ul style="list-style-type: none"> • showerhead: single-function standard • showerhead size: 3.75" diameter • tub spout length: 7" • tub spout connection type: slip fit • tub spout type: diverter • red/blue markings: included • valve: sold separately 		2.5 GPM (9.5 L/min) max.				
		T2813	283.05	Chrome	3	
		T2813BL	565.60	Matte Black	3	
		1.75 GPM (6.65 L/min) max.				
		T2813EP	283.05	Chrome	3	
		T2813EPBL	565.60	Matte Black	3	
<ul style="list-style-type: none"> • showerhead type: showerhead sold separately • tub spout length: 7" • tub spout connection type: slip fit • tub spout type: diverter • red/blue markings: included • valve: sold separately 		T2813NH	190.60	Chrome	3	
		T2813NHBL	409.90	Matte Black	3	
	POSI-TEMP® SHOWER ONLY TRIM					
	<ul style="list-style-type: none"> • showerhead: single-function standard • showerhead size: 3.75" diameter • red/blue markings: included • valve: sold separately 		2.5 GPM (9.5 L/min) max.			
		T2812	222.40	Chrome	3	
		T2812BL	445.00	Matte Black	3	
		1.75 GPM (6.65 L/min) max.				
		T2812EP	222.40	Chrome	3	
		T2812EPBL	445.00	Matte Black	3	
<ul style="list-style-type: none"> • showerhead type: showerhead sold separately • red/blue markings: included • valve: sold separately 		T2812NH	176.95	Chrome	3	
		T2812NHBL	353.50	Matte Black	3	
	POSI-TEMP® VALVE ONLY TRIM					
	<ul style="list-style-type: none"> • red/blue markings: included • valve: sold separately 		T2811	166.90	Chrome	3
		T2811BL	333.35	Matte Black	3	
POSI-TEMP® SHOWER MIXING VALVES						
<ul style="list-style-type: none"> • tub/shower or shower only application • ports: four with adjustable temp. limit stops • test plug: included 		2520 ◆	156.10	1/2" CC	6	
		2510 ◆	156.10	1/2" IPS	6	
<ul style="list-style-type: none"> • tub/shower or shower only application • ports: four with adjustable temp. limit stops • quarter turn stops: included • test plug: included 		2570 ◆	189.55	1/2" CC	6	
		2590 ◆	189.55	1/2" IPS	6	
		2580 ◆	156.10	1/2" Crimp ring PEX	6	
	<ul style="list-style-type: none"> • tub/shower only application • ports: four with adjustable temp. limit stops • quarter turn stops: included • test plug: included 		2360PF	208.45	1/2" Crimp Ring PEX	3
		2385PF	208.45	1/2" Cold Exp. PEX	3	
<ul style="list-style-type: none"> • shower only application • ports: three with adjustable temp. limit stops • quarter turn stops: included • test plug: included 		2326PF	201.20	1/2" Crimp Ring PEX	6	
		2328PF	201.20	1/2" Cold Exp. PEX	6	
<p>Four port valves can be used with either Tub/Shower or Shower Only applications. Three port valves can ONLY be used with Shower Only applications. For more product details, reference page 467-468 in valve section.</p>						
<p>HOW TO ORDER VALVES: PAGES 467-470</p>		<p>TRIM PART #</p>	+	<p>VALVE PART #</p>	=	<p>COMPLETE FAUCET</p>

RIZON®

		MODEL	LIST	FINISH/CONNECT	CASE QTY
POSI-TEMP® WITH INTEGRATED TRANSFER VALVE TRIM					
 <ul style="list-style-type: none"> • red/blue markings: included • valve: sold separately  		T2810	301.30	Chrome	4
		T2810BL	601.90	Matte Black	4
POSI-TEMP® WITH INTEGRATED TRANSFER VALVE					
 <ul style="list-style-type: none"> • functions: three (two independent and one shared) • ports: four with adjustable temp. limit stops • test plug: included 		2551	281.85	½" IPS	6
 <ul style="list-style-type: none"> • functions: three (two independent and one shared) • ports: four with adjustable temp. limit stops • stops: included • test plug: included 		2581	317.40	½" IPS	6
 <ul style="list-style-type: none"> • functions: two independent • ports: four with adjustable temp. limit stops • test plug: included 		2521	281.85	½" IPS	6
 <ul style="list-style-type: none"> • functions: two independent • ports: four with adjustable temp. limit stops • stops: included • test plug: included 		2571	317.40	½" IPS	6
For more product details, reference page 471 in valve section.					
HOW TO ORDER VALVES: PAGE 471	 TRIM PART #	+	 VALVE PART #	=	 COMPLETE FAUCET



GENTA™ LX Coordinating Bath Accessories

Moen® bath accessories CANNOT be combined with Moen faucet parts on a Purchase Order.

COORDINATING ACCESSORIES

Perfectly suited styles for a cohesive look. From robe hooks to towel bars, paper holders to knobs and pulls, Moen offers a variety of coordinating accessories to complete any room.

MODEL NUMBER	LIST EACH	DESCRIPTION	QTY
Chrome (CH)			
BH3803CH	29.15	Single Robe Hook	12 ▲
Ⓟ BH3808CH	50.10	Pivoting Paper Holder	3 ▲
BH3818CH	50.50	18" Towel Bar	3 ▲
BH3824CH	54.80	24" Towel Bar	3 ▲
BH3886CH	40.20	Hand Towel Bar	3 ▲
Matte Black (BL)			
BH3803BL	35.35	Single Robe Hook	24
Ⓟ BH3808BL	60.65	Pivoting Paper Holder	6
BH3818BL	61.10	18" Towel Bar	6
BH3824BL	66.25	24" Towel Bar	6
BH3886BL	48.60	Hand Towel Bar	6

Ⓟ Denotes pivoting paper holder



Single Robe Hook
BH3803



Pivoting Paper Holder
BH3808 | Ⓟ



Hand Towel Bar
BH3886



18" Towel Bar
BH3818

24" Towel Bar
BH3824

GRAB BARS ♿

MODEL NUMBER	LIST EACH	DESCRIPTION	QTY
1 1/2" • Chrome (CH)			
MBHG3818CH	141.40	18" Designer Grab Bar	3 ▲

SECUREMOUNT™

- SecureMount™ Grab Bars are manufactured with an innovative flange design that makes it easy to connect to the stud at multiple points.
- Tested to withstand 500lbs.
- To install grab bars securely without studs, use SecureMount™ Anchors. Sold separately.



18" Designer Grab Bar
MBHG3818



RIZON®

▲ Retail Packaging

- ♿ Complies with Americans with Disabilities Act (ADA) specifications. SecureMount™ Grab Bars are tested to withstand 500 lb. pull when securely installed per instructions.

List price is per each (unless otherwise noted). Product can be ordered by case quantity or individually. For more information on ordering bath accessories, contact Moen Bath Accessory Customer Service at 800-882-0116, contact your local Moen sales representative, or visit us at www.moen.com.

MODEL LIST FINISH/CONNECT CASE QTY

ONE-HANDLE BATHROOM FAUCET					
 <p>DECKPLATE INCLUDED</p> 	<ul style="list-style-type: none"> • application: one or three hole • supply lines: flexible • connection: 3/8" compression • deckplate: included • drain assembly: metal with lift rod 	<p>1.2 GPM (4.5L/min) max.</p>			
		6402	351.25	Chrome	3
		6402BN	456.65	Brushed Nickel	3
		Q3 NEW! 6402BL	474.20	Matte Black	3
		6402NL	491.75	Polished Nickel	3
		6402ORB	491.75	Oil Rubbed Bronze	3

TWO-HANDLE CENTERSET BATHROOM FAUCET					
	<ul style="list-style-type: none"> • application: three hole • center dimensions: 4" center • connection: 1/2" IPS • drain assembly: metal with lift rod 	<p>1.2 GPM (4.5L/min) max.</p>			
		6401	364.35	Chrome	3
		6401BN	473.70	Brushed Nickel	3
		Q3 NEW! 6401BL	491.90	Matte Black	3
		6401NL	510.10	Polished Nickel	3
		6401ORB	510.10	Oil Rubbed Bronze	3



TWO-HANDLE WIDESPREAD BATHROOM FAUCET TRIM					
	<ul style="list-style-type: none"> • application: three hole • center dimensions: 8" - 16" center • drain assembly: metal with lift rod • valve: sold separately 	<p>1.2 GPM (4.5L/min) max.</p>			
		T6405	382.05	Chrome	3
		T6405BN	534.90	Brushed Nickel	3
		Q3 NEW! T6405BL	554.00	Matte Black	3
		T6405NL	554.00	Polished Nickel	3
		T6405ORB	573.10	Oil Rubbed Bronze	3

WIDESPREAD FAUCET VALVE					
	<ul style="list-style-type: none"> • application: three hole • center dimensions: 8" - 16" center • drain assembly: metal with lift rod 	9000◆	162.15	1/2" IPS	6

HOW TO ORDER
VALVES: PAGE 463

 TRIM PART # +  VALVE PART # =  COMPLETE FAUCET

FREESTANDING TUB FILLER TRIM					
	<ul style="list-style-type: none"> • application: one hole • showerhead type: handshower • handshower functions: one-function • handshower flow rate: 1.75 gpm (6.65 L/min) max. • spout reach: 9.75" • mounting kit: sold separately 	<p>1.2 GPM (4.5L/min) max.</p>			
		9025	1874.95	Chrome	1
		9025BN	2531.20	Brushed Nickel	1
		9025NL	2531.20	Polished Nickel	1
		Q3 NEW! 9025BL	2624.95	Matte Black	1
		9025ORB	2784.35	Oil Rubbed Bronze	1







FREESTANDING TUB FILLER VALVE AND MOUNTING KIT - PREMIUM					
	<ul style="list-style-type: none"> • description: single riser floor joist mounting kit • application: one hole • quarter turn stops: included 	TS50100	400.90	1/2" CC, NPT	2
	<ul style="list-style-type: none"> • description: single riser concrete mounting kit • application: one hole • connection size: 1/2" 	TS50110	325.95	1/2" CC, NPT	2













HOW TO ORDER
VALVES: PAGE 463

 TRIM PART # +  VALVE PART # =  COMPLETE FAUCET



















BELFIELD™ Collection

		MODEL	LIST	FINISH/CONNECT	CASE QTY
ONE-HANDLE WALLMOUNT TUB FILLER TRIM					
 <ul style="list-style-type: none"> • application: two hole • connection: 1/2" slip fit • tub spout type: non diverter • spout reach: 10.00" • includes: high flow volume control cartridge Q3 NEW! • WMV130 series valve kit: sold separately 		WT9021	630.00	Chrome	3
		WT9021BN	875.70	Brushed Nickel	3
		WT9021NL	875.70	Polished Nickel	3
		WT9021BL	914.30	Matte Black	3
		WT9021ORB	963.30	Oil Rubbed Bronze	3
ONE-HANDLE WALLMOUNT TUB FILLER VALVE KIT					
 <ul style="list-style-type: none"> • application: two hole with adj. center dimensions • ports: three • quarter turn stops: included • includes: test plug • includes: spout manifold 		WMV130CIS	151.05	1/2" CC/IPS	6
		WMV130XS	151.05	1/2" Crimp Ring PEX	6
		WMV130CXS	151.05	1/2" Cold Exp. PEX	6
HOW TO ORDER VALVES: PAGE 463	 TRIM PART #   VALVE PART #   COMPLETE FAUCET				



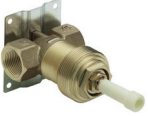



























TWO-HANDLE ROMAN TUB TRIM					
 <ul style="list-style-type: none"> • application: three hole • spout reach: 7.50" • valve: sold separately 		T9023	471.85	Chrome	3
		T9023BN	663.10	Brushed Nickel	3
		T9023NL	663.10	Polished Nickel	3
		T9023BL	684.20	Matte Black	3
		T9023ORB	720.05	Oil Rubbed Bronze	3
 <ul style="list-style-type: none"> • application: four hole • showerhead type: handshower • handshower flow rate: 1.75 gpm (6.65 L/min) max. • spray functions: one-function • spout reach: 7.50" • valve: sold separately 		T9024	641.30	Chrome	3
		T9024BN	903.05	Brushed Nickel	3
		T9024NL	903.05	Polished Nickel	3
		T9024BL	929.85	Matte Black	3
		T9024ORB	968.50	Oil Rubbed Bronze	3
TWO-HANDLE ROMAN TUB VALVE					
 <ul style="list-style-type: none"> • deck thickness: 1/8" to 3-3/8" rough-in deck • adjustable spout shank: adjustable center dimensions 		4792	188.55	1/2" CC	6
	DURALAST®				
 <ul style="list-style-type: none"> • deck thickness: 1/8" to 2-3/4" rough-in deck • adjustable spout shank: 10" - 24" center dimensions 		4793	213.55	1/2" CPVC, Crimp Ring PEX	6
		4794	203.60	1/2" Crimp Ring PEX, Cold Exp. PEX	6
DURALOCK® DURALAST®					
 <ul style="list-style-type: none"> • deck thickness: 1/8" to 3-3/16" rough-in deck • Non-adjustable spout shank: 10" center dimensions 		4796	177.65	1/2" CC	6
		4797	181.10	1/2" CPVC, Crimp Ring PEX	6
		4798	181.10	1/2" Crimp Ring PEX, Cold Exp. PEX	6
DURALAST®					
TWO-HANDLE ROMAN TUB VALVE WITH HANDSHOWER					
 <ul style="list-style-type: none"> • deck thickness: 1/8" to 2-5/8" rough-in deck • non-adj spout shank: adjustable center dim's 		9792	424.85	1/2" CC	6
	DURALAST®				
 <ul style="list-style-type: none"> • deck thickness: 1/8" to 2-5/8" rough-in deck • adj spout shank: 10" - 24" center dimensions 		9793	434.80	1/2" CPVC, Crimp Ring PEX	6
	DURALOCK® DURALAST®				
For more product details, reference page 464 in valve section.					
HOW TO ORDER VALVES: PAGE 464	 TRIM PART #   VALVE PART #   COMPLETE FAUCET				

BELFIELD™

		MODEL	LIST	FINISH/CONNECT	CASE QTY	
EXACTTEMP® VALVE ONLY TRIM						
 <ul style="list-style-type: none"> • description: temperature control valve trim • requires: separate volume control valve • valve: sold separately  		T4411	304.30	Chrome	3	
		T4411BN	458.40	Brushed Nickel	3	
		T4411NL	458.40	Polished Nickel	3	
	Q3 	T4411BL	471.65	Matte Black	3	
		T4411ORB	494.50	Oil Rubbed Bronze	3	
EXACTTEMP® THERMOSTATIC MIXING SHOWER VALVE - PREMIUM						
 <ul style="list-style-type: none"> • description: thermostatic rough-in valve • ports: four with adjustable temp. limit stops • check stops: included 		S3371	714.65	¾" IPS	6	
HOW TO ORDER VALVES: PAGE 465		 TRIM PART #	+	 VALVE PART #	=	 COMPLETE FAUCET

















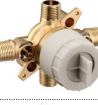

EXACTTEMP® VOLUME CONTROL VALVE TRIM						
 <ul style="list-style-type: none"> • valve: sold separately  		T4412	154.50	Chrome	6	
		T4412BN	232.90	Brushed Nickel	6	
		T4412NL	232.90	Polished Nickel	6	
	Q3 	T4412BL	239.45	Matte Black	6	
		T4412ORB	251.15	Oil Rubbed Bronze	6	
EXACTTEMP® VOLUME CONTROL SHOWER VALVE - PREMIUM						
 <ul style="list-style-type: none"> • includes: volume control 		S3600	181.70	¾" IPS	12	
HOW TO ORDER VALVES: PAGE 465		 TRIM PART #	+	 VALVE PART #	=	 COMPLETE FAUCET

BELFIELD™ Collection

		MODEL	LIST	FINISH/CONNECT	CASE QTY
M-CORE® 4-SERIES TUB/SHOWER TRIM					
 <ul style="list-style-type: none"> • showerhead: single-function eco-performance rainshower • showerhead size: 7" diameter • tub spout length: 7 3/4" • tub spout connection type: slip fit • tub spout type: diverter • includes: thermostatic cartridge with volume and temperature control • valve: sold separately 		 1.75 GPM (6.65 L/min) max.			
	Q2 	UT4313EP	616.30	Chrome	4
	Q2 	UT4313EPBN	947.50	Brushed Nickel	4
	Q2 	UT4313EPNL	947.50	Polished Nickel	4
	Q3 	UT4313EPBL	977.25	Matte Black	4
	Q2 	UT4313EPORB	1055.05	Oil Rubbed Bronze	4
					
M-CORE® 4-SERIES SHOWER ONLY TRIM					
 <ul style="list-style-type: none"> • showerhead: single-function eco-performance rainshower • showerhead size: 7" diameter • includes: thermostatic cartridge with volume and temperature control • valve: sold separately 		 1.75 GPM (6.65 L/min) max.			
	Q2 	UT4312EP	524.85	Chrome	4
	Q2 	UT4312EPBN	779.10	Brushed Nickel	4
	Q2 	UT4312EPNL	779.10	Polished Nickel	4
	Q3 	UT4312EPBL	797.75	Matte Black	4
	Q2 	UT4312EPORB	865.95	Oil Rubbed Bronze	4
					
M-CORE® 4-SERIES VALVE ONLY TRIM					
 <ul style="list-style-type: none"> • includes: thermostatic cartridge with volume and temperature control • valve: sold separately 	Q2 	UT4311	455.75	Chrome	3
	Q2 	UT4311BN	682.80	Brushed Nickel	3
	Q2 	UT4311NL	682.80	Polished Nickel	3
	Q3 	UT4311BL	696.25	Matte Black	3
	Q2 	UT4311ORB	722.45	Oil Rubbed Bronze	3
					
M-CORE® MIXING SHOWER VALVE					
 <ul style="list-style-type: none"> • tub/shower or shower only application • ports: four with adj. temp. limit stops • included: test plug and cross flow plug 		U140CI	71.20	1/2" CC/IPS	6
		U140X	71.20	1/2" Crimp Ring PEX + CC/IPS Tub	6
		U140CX	71.20	1/2" Cold Exp. PEX + CC/IPS Tub	6
		U140V	87.20	1/2" CPVC + CC/IPS Tub	6
 <ul style="list-style-type: none"> • tub/shower or shower only application • ports: four with adj. temp. limit stops • quarter turn stops: included 		U140CIS	102.45	1/2" CC/IPS	6
		U140XS	102.45	1/2" Crimp Ring PEX + CC/IPS Tub	6
		U140CXS	102.45	1/2" Cold Exp. PEX + CC/IPS Tub	6
		U140VS	118.50	1/2" CPVC + CC/IPS Tub	6
 <ul style="list-style-type: none"> • tub/shower only application • ports: four with adj. temp. limit stops • tub outlet: pre-fabricated 1/2" copper tube • included: quarter turn stops and plugs 		U140X-PF	80.40	1/2" Crimp Ring PEX	6
		U140CX-PF	80.40	1/2" Cold Exp. PEX	6
 <ul style="list-style-type: none"> • tub/shower only application • ports: four with adj. temp. limit stops • tub outlet: pre-fabricated 1/2" copper tube • included: quarter turn stops and plugs 		U140XS-PF	111.70	1/2" Crimp Ring PEX	6
		U140CXS-PF	111.70	1/2" Cold Exp. PEX	6
 <ul style="list-style-type: none"> • shower only application • ports: three 		U130CI	71.20	1/2" CC/IPS	6
		U130X	71.20	1/2" Crimp Ring PEX	6
		U130CX	71.20	1/2" Cold Exp. PEX	6
 <ul style="list-style-type: none"> • shower only application • ports: three • quarter turn stops: included 		U130CIS	102.45	1/2" CC/IPS	6
		U130XS	102.45	1/2" Crimp Ring PEX	6
		U130CXS	102.45	1/2" Cold Exp. PEX	6
<p>Four port valves can be used with either Tub/Shower or Shower Only applications. Three port valves can ONLY be used with Shower Only applications. For more product details, reference pages 465-466 in valve section.</p>					
<p>HOW TO ORDER VALVES: PAGES 465-466</p>					

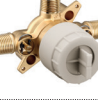

















BELFIELD™











MODEL LIST FINISH/CONNECT CASE QTY











M-CORE® 3-SERIES TUB/SHOWER TRIM					
 <ul style="list-style-type: none"> • showerhead: single-function rainshower • showerhead size: 7" diameter • tub spout length: 7 3/4" • tub spout connection type: slip fit • tub spout type: diverter • includes: pressure balanced cartridge with volume and temperature control • valve: sold separately 	<p>2.5 GPM (9.5 L/min) max.</p>				
	Q3 NEW!	UT3313	481.30	Chrome	4
		UT3313BN	812.50	Brushed Nickel	4
		UT3313NL	812.50	Polished Nickel	4
		UT3313BL	842.25	Matte Black	4
		UT3313ORB	920.05	Oil Rubbed Bronze	4
		1.75 GPM (6.65 L/min) max.			
		UT3313EP	481.30	Chrome	4
		UT3313EPBN	812.50	Brushed Nickel	4
		UT3313EPNL	812.50	Polished Nickel	4
Q3 NEW!	UT3313EPBL	842.25	Matte Black	4	
	UT3313EPORB	920.05	Oil Rubbed Bronze	4	
M-CORE® 3-SERIES SHOWER ONLY TRIM					
 <ul style="list-style-type: none"> • showerhead: single-function rainshower • showerhead size: 7" diameter • includes: pressure balanced cartridge with volume and temperature control • valve: sold separately 	<p>2.5 GPM (9.5 L/min) max.</p>				
	Q3 NEW!	UT3312	389.85	Chrome	4
		UT3312BN	644.10	Brushed Nickel	4
		UT3312NL	644.10	Polished Nickel	4
		UT3312BL	662.75	Matte Black	4
		UT3312ORB	730.95	Oil Rubbed Bronze	4
		1.75 GPM (6.65 L/min) max.			
		UT3312EP	389.85	Chrome	4
		UT3312EPBN	644.10	Brushed Nickel	4
		UT3312EPNL	644.10	Polished Nickel	4
Q3 NEW!	UT3312EPBL	662.75	Matte Black	4	
	UT3312EPORB	730.95	Oil Rubbed Bronze	4	
M-CORE® MIXING SHOWER VALVE					
 <ul style="list-style-type: none"> • tub/shower or shower only application • ports: four with adj. temp. limit stops • included: test plug and cross flow plug 	U140CI	71.20	1/2" CC/IPS	6	
		U140X	71.20	1/2" Crimp Ring PEX + CC/IPS Tub	6
		U140CX	71.20	1/2" Cold Exp. PEX + CC/IPS Tub	6
		U140V	87.20	1/2" CPVC + CC/IPS Tub	6
	 <ul style="list-style-type: none"> • tub/shower or shower only application • ports: four with adj. temp. limit stops • quarter turn stops: included 	U140CIS	102.45	1/2" CC/IPS	6
		U140XS	102.45	1/2" Crimp Ring PEX + CC/IPS Tub	6
		U140CXS	102.45	1/2" Cold Exp. PEX + CC/IPS Tub	6
		U140VS	118.50	1/2" CPVC + CC/IPS Tub	6
 <ul style="list-style-type: none"> • tub/shower only application • ports: four with adj. temp. limit stops • tub outlet: pre-fabricated 1/2" copper tube • included: quarter turn stops and plugs 		U140X-PF	80.40	1/2" Crimp Ring PEX	6
		U140CX-PF	80.40	1/2" Cold Exp. PEX	6
 <ul style="list-style-type: none"> • tub/shower only application • ports: four with adj. temp. limit stops • tub outlet: pre-fabricated 1/2" copper tube • included: quarter turn stops and plugs 	U140XS-PF	111.70	1/2" Crimp Ring PEX	6	
		U140CXS-PF	111.70	1/2" Cold Exp. PEX	6
 <ul style="list-style-type: none"> • shower only application • ports: three 	U130CI	71.20	1/2" CC/IPS	6	
		U130X	71.20	1/2" Crimp Ring PEX	6
		U130CX	71.20	1/2" Cold Exp. PEX	6
 <ul style="list-style-type: none"> • shower only application • ports: three • quarter turn stops: included 	U130CIS	102.45	1/2" CC/IPS	6	
		U130XS	102.45	1/2" Crimp Ring PEX	6
		U130CXS	102.45	1/2" Cold Exp. PEX	6
<p>Four port valves can be used with either Tub/Shower or Shower Only applications. Three port valves can ONLY be used with Shower Only applications. For more product details, reference pages 465-466 in valve section.</p>					
<p>HOW TO ORDER VALVES: PAGES 465-466</p>	 <p>TRIM PART #</p>	+	 <p>VALVE PART #</p>	=	 <p>COMPLETE FAUCET</p>























BELFIELD™ Collection

		MODEL	LIST	FINISH/CONNECT	CASE QTY
M-CORE® 3-SERIES VALVE ONLY TRIM					
 <ul style="list-style-type: none"> • includes: pressure balanced cartridge with volume and temperature control • valve: sold separately 	 	UT3311	320.75	Chrome	3
		UT3311BN	547.80	Brushed Nickel	3
		UT3311NL	547.80	Polished Nickel	3
		Q3  UT3311BL	561.25	Matte Black	3
		UT3311ORB	587.45	Oil Rubbed Bronze	3
M-CORE® MIXING SHOWER VALVE					
 <ul style="list-style-type: none"> • tub/shower or shower only application • ports: four with adj. temp. limit stops • included: test plug and cross flow plug 		U140CI	71.20	1/2" CC/IPS	6
		U140X	71.20	1/2" Crimp Ring PEX + CC/IPS Tub	6
		U140CX	71.20	1/2" Cold Exp. PEX + CC/IPS Tub	6
		U140V	87.20	1/2" CPVC + CC/IPS Tub	6
 <ul style="list-style-type: none"> • tub/shower or shower only application • ports: four with adj. temp. limit stops • quarter turn stops: included 		U140CIS	102.45	1/2" CC/IPS	6
		U140XS	102.45	1/2" Crimp Ring PEX + CC/IPS Tub	6
		U140CXS	102.45	1/2" Cold Exp. PEX + CC/IPS Tub	6
		U140VS	118.50	1/2" CPVC + CC/IPS Tub	6
 <ul style="list-style-type: none"> • tub/shower only application • ports: four with adj. temp. limit stops • tub outlet: pre-fabricated 1/2" copper tube • included: quarter turn stops and plugs 		U140X-PF	80.40	1/2" Crimp Ring PEX	6
		U140CX-PF	80.40	1/2" Cold Exp. PEX	6
 <ul style="list-style-type: none"> • tub/shower only application • ports: four with adj. temp. limit stops • tub outlet: pre-fabricated 1/2" copper tube • included: quarter turn stops and plugs 		U140XS-PF	111.70	1/2" Crimp Ring PEX	6
		U140CXS-PF	111.70	1/2" Cold Exp. PEX	6
 <ul style="list-style-type: none"> • shower only application • ports: three 		U130CI	71.20	1/2" CC/IPS	6
		U130X	71.20	1/2" Crimp Ring PEX	6
		U130CX	71.20	1/2" Cold Exp. PEX	6
 <ul style="list-style-type: none"> • shower only application • ports: three • quarter turn stops: included 		U130CIS	102.45	1/2" CC/IPS	6
		U130XS	102.45	1/2" Crimp Ring PEX	6
		U130CXS	102.45	1/2" Cold Exp. PEX	6
<p>Four port valves can be used with either Tub/Shower or Shower Only applications. Three port valves can ONLY be used with Shower Only applications. For more product details, reference pages 465-466 in valve section.</p>					
<p>HOW TO ORDER VALVES: PAGES 465-466</p>	 <p>TRIM PART #</p>	+	 <p>VALVE PART #</p>	=	 <p>COMPLETE FAUCET</p>

		MODEL	LIST	FINISH/CONNECT	CASE QTY		
M-CORE® 3-SERIES WITH INTEGRATED TRANSFER VALVE TRIM							
 <ul style="list-style-type: none"> • includes: pressure balanced cartridge with volume and temperature control • valve: sold separately 	 	UT3322	328.90	Chrome	4		
		UT3322BN	407.75	Brushed Nickel	4		
		UT3322NL	407.75	Polished Nickel	4		
		Q3  UT3322BL	427.55	Matte Black	4		
		UT3322ORB	438.65	Oil Rubbed Bronze	4		
M-CORE® WITH INTEGRATED TRANSFER VALVE							
Three Function (2 independent/1 shared) OR Six Function (3 independent/3 shared) - plumbing configuration page 472							
 <ul style="list-style-type: none"> • ports: four with adj. temp. limit stops • check stops: included 		U362CIS	265.40	1/2" CC/IPS	6		
		U362CXS	265.40	1/2" Cold Exp. PEX	6		
		U362XS	265.40	1/2" Crimp Ring PEX	6		
Two Independent Functions OR Three Independent Functions - plumbing configurations page 472							
 <ul style="list-style-type: none"> • ports: four with adj. temp. limit stops • check stops: included 		U232CIS	265.40	1/2" CC/IPS	6		
		U232CXS	265.40	1/2" Cold Exp. PEX	6		
		U232XS	265.40	1/2" Crimp Ring PEX	6		
For more product details, reference page 466 in valve section. See page 472 for plumbing configurations.							
HOW TO ORDER VALVES: PAGE 466		TRIM PART #	+		=		COMPLETE FAUCET















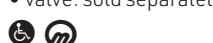
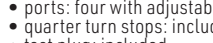

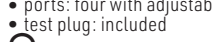
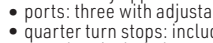



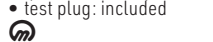

M-CORE® TRANSFER VALVE TRIM							
 <ul style="list-style-type: none"> • use with the M-CORE® transfer valve • valve: sold separately 	 	UT4301	222.00	Chrome	12		
		UT4301BN	272.75	Brushed Nickel	12		
		UT4301NL	272.75	Polished Nickel	12		
		Q3  UT4301BL	277.50	Matte Black	12		
		UT4301ORB	292.45	Oil Rubbed Bronze	12		
M-CORE® TRANSFER VALVE							
Three Function (2 independent/1 shared) OR Six Function (3 independent/3 shared) - plumbing configuration page 472							
 <ul style="list-style-type: none"> • number of functions: three or six • ports: four 		U361CI	149.70	1/2" CC/IPS	6		
		U361CX	149.70	1/2" Cold Exp. PEX	6		
		U361X	149.70	1/2" Crimp Ring PEX	6		
Two Independent Functions OR Three Independent Functions - plumbing configurations page 472							
 <ul style="list-style-type: none"> • number of functions: two or three • ports: four 		U231CI	149.70	1/2" CC/IPS	6		
		U231CX	149.70	1/2" Cold Exp. PEX	6		
		U231X	149.70	1/2" Crimp Ring PEX	6		
For more product details, reference page 466 in valve section. See page 472 for plumbing configurations.							
HOW TO ORDER VALVES: PAGE 466		TRIM PART #	+		=		COMPLETE FAUCET

BELFIELD™ Collection

		MODEL	LIST	FINISH/CONNECT	CASE QTY	
M-CORE® 2-SERIES TUB/SHOWER TRIM						
 <ul style="list-style-type: none"> • showerhead: single-function eco-performance rainshower • showerhead size: 7" diameter • tub spout length: 7 3/4" • tub spout connection type: slip fit • tub spout type: diverter • includes: pressure balanced cartridge with temperature control • valve: sold separately 		1.75 GPM (6.65 L/min) max.				
			UT2313EP	398.60	Chrome	4
			UT2313EPBN	621.55	Brushed Nickel	4
			UT2313EPNL	621.55	Polished Nickel	4
			UT2313EPBL	637.80	Matte Black	4
			UT2313EPORB	671.35	Oil Rubbed Bronze	4
M-CORE® 2-SERIES SHOWER ONLY TRIM						
 <ul style="list-style-type: none"> • showerhead: single-function eco-performance rainshower • showerhead size: 7" diameter • includes: pressure balanced cartridge with temperature control • valve: sold separately 		1.75 GPM (6.65 L/min) max.				
			UT2312EP	340.45	Chrome	4
			UT2312EPBN	515.95	Brushed Nickel	3
			UT2312EPNL	515.95	Polished Nickel	4
			UT2312EPBL	527.70	Matte Black	4
			UT2312EPORB	554.75	Oil Rubbed Bronze	4
M-CORE® 2-SERIES VALVE ONLY TRIM						
 <ul style="list-style-type: none"> • includes: pressure balanced cartridge with temperature control • valve: sold separately 		UT2311	286.95	Chrome	3	
			UT2311BN	418.10	Brushed Nickel	3
			UT2311NL	418.10	Polished Nickel	3
			UT2311BL	430.45	Matte Black	3
			UT2311ORB	447.35	Oil Rubbed Bronze	3
		M-CORE® MIXING SHOWER VALVE				
 <ul style="list-style-type: none"> • tub/shower or shower only application • ports: four with adj. temp. limit stops • included: test plug and cross flow plug 		U140CI	71.20	1/2" CC/IPS	6	
			U140X	71.20	1/2" Crimp Ring PEX + CC/IPS Tub	6
			U140CX	71.20	1/2" Cold Exp. PEX + CC/IPS Tub	6
			U140V	87.20	1/2" CPVC + CC/IPS Tub	6
 <ul style="list-style-type: none"> • tub/shower or shower only application • ports: four with adj. temp. limit stops • quarter turn stops: included 		U140CIS	102.45	1/2" CC/IPS	6	
			U140XS	102.45	1/2" Crimp Ring PEX + CC/IPS Tub	6
			U140CXS	102.45	1/2" Cold Exp. PEX + CC/IPS Tub	6
			U140VS	118.50	1/2" CPVC + CC/IPS Tub	6
 <ul style="list-style-type: none"> • tub/shower only application • ports: four with adj. temp. limit stops • tub outlet: pre-fabricated 1/2" copper tube • included: quarter turn stops and plugs 		U140X-PF	80.40	1/2" Crimp Ring PEX	6	
			U140CX-PF	80.40	1/2" Cold Exp. PEX	6
 <ul style="list-style-type: none"> • tub/shower only application • ports: four with adj. temp. limit stops • tub outlet: pre-fabricated 1/2" copper tube • included: quarter turn stops and plugs 		U140XS-PF	111.70	1/2" Crimp Ring PEX	6	
			U140CXS-PF	111.70	1/2" Cold Exp. PEX	6
 <ul style="list-style-type: none"> • shower only application • ports: three 		U130CI	71.20	1/2" CC/IPS	6	
			U130X	71.20	1/2" Crimp Ring PEX	6
			U130CX	71.20	1/2" Cold Exp. PEX	6
 <ul style="list-style-type: none"> • shower only application • ports: three • quarter turn stops: included 		U130CIS	102.45	1/2" CC/IPS	6	
			U130XS	102.45	1/2" Crimp Ring PEX	6
			U130CXS	102.45	1/2" Cold Exp. PEX	6
<p>Four port valves can be used with either Tub/Shower or Shower Only applications. Three port valves can ONLY be used with Shower Only applications. For more product details, reference pages 465-466 in valve section.</p>						
<p>HOW TO ORDER VALVES: PAGES 465-466</p>		 <p>TRIM PART #</p>	+	 <p>VALVE PART #</p>	=	 <p>COMPLETE FAUCET</p>













BELFIELD™

MODEL LIST FINISH/CONNECT CASE QTY

POSI-TEMP® TUB/SHOWER TRIM					
 <ul style="list-style-type: none"> • showerhead: single-function rainshower • showerhead size: 7" diameter • tub spout length: 7 3/4" • tub spout connection type: slip fit • tub spout type: diverter • valve: sold separately 	<ul style="list-style-type: none"> • showerhead: single-function rainshower • showerhead size: 7" diameter • valve: sold separately 	<p>2.5 GPM (9.5 L/min) max.</p>			
	T2313	272.50	Chrome	4	
	T2313BN	495.40	Brushed Nickel	4	
	T2313NL	495.40	Polished Nickel	4	
	Q3 NEW! T2313BL	504.15	Matte Black	4	
	T2313ORB	545.25	Oil Rubbed Bronze	4	
	<p>1.75 GPM (6.65 L/min) max.</p>				
	T2313EP	272.50	Chrome	4	
	T2313EPBN	495.40	Brushed Nickel	4	
	T2313EPNL	495.40	Polished Nickel	4	
Q3 NEW! T2313EPBL	504.15	Matte Black	4		
T2313EPORB	545.25	Oil Rubbed Bronze	4		
POSI-TEMP® SHOWER ONLY TRIM					
 <ul style="list-style-type: none"> • showerhead: single-function rainshower • showerhead size: 7" diameter • valve: sold separately 	<ul style="list-style-type: none"> • showerhead: single-function rainshower • showerhead size: 7" diameter • valve: sold separately 	<p>2.5 GPM (9.5 L/min) max.</p>			
	T2312	214.30	Chrome	4	
	T2312BN	389.80	Brushed Nickel	4	
	T2312NL	389.80	Polished Nickel	4	
	Q3 NEW! T2312BL	396.45	Matte Black	4	
	T2312ORB	428.60	Oil Rubbed Bronze	4	
	<p>1.75 GPM (6.65 L/min) max.</p>				
	T2312EP	214.30	Chrome	4	
	T2312EPBN	389.80	Brushed Nickel	4	
	T2312EPNL	389.80	Polished Nickel	4	
Q3 NEW! T2312EPBL	396.45	Matte Black	4		
T2312EPORB	428.60	Oil Rubbed Bronze	4		
POSI-TEMP® VALVE ONLY TRIM					
 <ul style="list-style-type: none"> • valve: sold separately 	<ul style="list-style-type: none"> • valve: sold separately 				
	T2311	160.85	Chrome	3	
	T2311BN	292.00	Brushed Nickel	3	
	T2311NL	292.00	Polished Nickel	3	
	Q3 NEW! T2311BL	297.60	Matte Black	3	
	T2311ORB	321.20	Oil Rubbed Bronze	3	
POSI-TEMP® SHOWER MIXING VALVES					
 <ul style="list-style-type: none"> • tub/shower or shower only application • ports: four with adjustable temp. limit stops • test plug: included 	<ul style="list-style-type: none"> • tub/shower or shower only application • ports: four with adjustable temp. limit stops • quarter turn stops: included • test plug: included 	<p>2520 ◆</p>	156.10	1/2" CC	6
			2510 ◆	156.10	1/2" IPS
 <ul style="list-style-type: none"> • tub/shower or shower only application • ports: four with adjustable temp. limit stops • quarter turn stops: included • test plug: included 	<ul style="list-style-type: none"> • tub/shower or shower only application • ports: four with adjustable temp. limit stops • quarter turn stops: included • test plug: included 	<p>2570 ◆</p>	189.55	1/2" CC	6
		2590 ◆	189.55	1/2" IPS	6
		2580 ◆	156.10	1/2" Crimp ring PEX	6
 <ul style="list-style-type: none"> • tub/shower only application • ports: two with adjustable temp. limit stops • quarter turn stops: included • test plug: included 	<ul style="list-style-type: none"> • tub/shower only application • ports: two with adjustable temp. limit stops • quarter turn stops: included • test plug: included 	<p>2360PF</p>	208.45	1/2" Crimp Ring PEX	3
		2385PF	208.45	1/2" Cold Exp. PEX	3
 <ul style="list-style-type: none"> • shower only application • ports: three with adjustable temp. limit stops • quarter turn stops: included • test plug: included 	<ul style="list-style-type: none"> • shower only application • ports: three with adjustable temp. limit stops • quarter turn stops: included • test plug: included 	<p>2326PF</p>	201.20	1/2" Crimp Ring PEX	6
		2328PF	201.20	1/2" Cold Exp. PEX	6
<p>Four port valves can be used with either Tub/Shower or Shower Only applications. Three port valves can ONLY be used with Shower Only applications. For more product details, reference page 467-468 in valve section.</p>					
<p>HOW TO ORDER VALVES: PAGES 467-470</p>	 TRIM PART #	+	 VALVE PART #	=	 COMPLETE FAUCET

BELFIELD™

BELFIELD™ Collection

		MODEL	LIST	FINISH/CONNECT	CASE QTY	
POSI-TEMP® WITH INTEGRATED TRANSFER VALVE TRIM						
 <ul style="list-style-type: none"> • valve: sold separately 	 	T2310	290.35	Chrome	4	
		T2310BN	527.20	Brushed Nickel	4	
		T2310NL	527.20	Polished Nickel	4	
		Q3  T2310BL	537.15	Matte Black	4	
		T2310ORB	579.95	Oil Rubbed Bronze	4	
POSI-TEMP® WITH INTEGRATED TRANSFER VALVE						
 <ul style="list-style-type: none"> • functions: three (two independent and one shared) • ports: four with adjustable temp. limit stops • test plug: included 		2551	281.85	1/2" IPS	6	
 <ul style="list-style-type: none"> • functions: three (two independent and one shared) • ports: four with adjustable temp. limit stops • stops: included • test plug: included 		2581	317.40	1/2" IPS	6	
 <ul style="list-style-type: none"> • functions: two independent • ports: four with adjustable temp. limit stops • test plug: included 		2521	281.85	1/2" IPS	6	
 <ul style="list-style-type: none"> • functions: two independent • ports: four with adjustable temp. limit stops • stops: included • test plug: included 		2571	317.40	1/2" IPS	6	
For more product details, reference page 471 in valve section.						
HOW TO ORDER VALVES: PAGE 471		 TRIM PART #	+	 VALVE PART #	=	 COMPLETE FAUCET

Moen® bath accessories CANNOT be combined with Moen faucet parts on a Purchase Order.

A PERFECT MATCH

A line of perfectly matching accessories - including tank levers and towel bars - allow for a completely cohesive look in the bath.

MODEL NUMBER	LIST EACH	DESCRIPTION	QTY
Chrome (CH)			
YB6401CH	45.35	Tank Lever	24
YB6403CH	34.90	Double Robe Hook	24
(P) YB6408CH	63.70	Pivoting Paper Holder	6
YB6418CH	74.05	18" Towel Bar	6
YB6422CH	99.10	24" Double Towel Bar	6
YB6424CH	76.35	24" Towel Bar	6
YB6486CH	52.00	Hand Towel Bar	6
Brushed Nickel (BN)			
YB6401BN	50.05	Tank Lever	24
YB6403BN	38.40	Double Robe Hook	24
(P) YB6408BN	70.45	Pivoting Paper Holder	6
YB6418BN	81.30	18" Towel Bar	6
YB6422BN	106.70	24" Double Towel Bar	6
YB6424BN	84.30	24" Towel Bar	6
YB6486BN	56.80	Hand Towel Bar	6
Matte Black (BL)			
YB6401BL	55.05	Tank Lever	24 NEW! Q3
YB6403BL	42.35	Double Robe Hook	24 NEW! Q3
(P) YB6408BL	77.60	Pivoting Paper Holder	6 NEW! Q3
YB6418BL	89.50	18" Towel Bar	6 NEW! Q3
YB6422BL	117.50	24" Double Towel Bar	6 NEW! Q3
YB6424BL	92.70	24" Towel Bar	6 NEW! Q3
YB6486BL	62.55	Hand Towel Bar	6 NEW! Q3
Polished Nickel (NL)			
YB6401NL	54.90	Tank Lever	24
YB6403NL	42.35	Double Robe Hook	24
(P) YB6408NL	83.00	Pivoting Paper Holder	6
YB6418NL	89.60	18" Towel Bar	6
YB6422NL	120.05	24" Double Towel Bar	6
YB6424NL	92.45	24" Towel Bar	6
YB6486NL	67.45	Hand Towel Bar	6
Oil Rubbed Bronze (ORB)			
YB6401ORB	55.05	Tank Lever	24
YB6403ORB	42.35	Double Robe Hook	24
(P) YB6408ORB	77.60	Pivoting Paper Holder	6
YB6418ORB	89.50	18" Towel Bar	6
YB6422ORB	117.50	24" Double Towel Bar	6
YB6424ORB	92.70	24" Towel Bar	6
YB6486ORB	62.55	Hand Towel Bar	6

(P) Denotes pivoting paper holder



Tank Lever
YB6401



Double Robe Hook
YB6403



Pivoting Paper Holder
YB6408 | (P)



Hand Towel Bar
YB6486



18" Towel Bar
YB6418



24" Double Towel Bar
YB6422

24" Towel Bar
YB6424



List price is per each (unless otherwise noted).
Product can be ordered by case quantity or individually.
For more information on ordering bath accessories, contact Moen Bath Accessory Customer Service at 800-882-0116, contact your local Moen sales representative, or visit us at www.moen.com.

**GRAB BARS** 

MODEL NUMBER	LIST EACH	DESCRIPTION	QTY
1½" • Chrome (CH)			
YG6412CH	124.10	12" Designer Grab Bar	6
YG6418CH	129.65	18" Designer Grab Bar	6
YG6424CH	135.40	24" Designer Grab Bar	6
1½" • Brushed Nickel (BN)			
YG6412BN	149.90	12" Designer Grab Bar	6
YG6418BN	157.20	18" Designer Grab Bar	6
YG6424BN	169.55	24" Designer Grab Bar	6
1½" • Polished Nickel (NL)			
YG6412NL	149.90	12" Designer Grab Bar	6
YG6418NL	156.65	18" Designer Grab Bar	6
YG6424NL	163.60	24" Designer Grab Bar	6
1½" • Oil Rubbed Bronze (ORB)			
YG6412ORB	164.95	12" Designer Grab Bar	6
YG6418ORB	172.90	18" Designer Grab Bar	6
YG6424ORB	186.60	24" Designer Grab Bar	6
1½" • Matte Black (BL)			
YG6412BL	149.90	12" Designer Grab Bar	6
YG6418BL	156.65	18" Designer Grab Bar	6
YG6424BL	163.60	24" Designer Grab Bar	6

SECUREMOUNT™

- SecureMount™ Grab Bars are manufactured with an innovative flange design that makes it easy to connect to the stud at multiple points.
- Tested to withstand 500lbs.
- To install grab bars securely without studs, use SecureMount™ Anchors. Sold separately.

**24" Designer Grab Bar**

YG6424

 Complies with Americans with Disabilities Act (ADA) specifications. SecureMount™ Grab Bars are tested to withstand 500 lb. pull when securely installed per instructions.

List price is per each (unless otherwise noted). Product can be ordered by case quantity or individually.



LIGHTING

MODEL NUMBER	LIST EACH	DESCRIPTION	QTY
Chrome (CH)			
YB6461CH	177.90	One Globe Bath Light	1
YB6462CH	248.85	Two Globe Bath Light	1
YB6463CH	308.90	Three Globe Bath Light	1
YB6464CH	395.65	Four Globe Bath Light	1
Brushed Nickel (BN)			
YB6461BN	222.30	One Globe Bath Light	1
YB6462BN	311.00	Two Globe Bath Light	1
YB6463BN	386.20	Three Globe Bath Light	1
YB6464BN	494.60	Four Globe Bath Light	1
Polished Nickel (NL)			
YB6461NL	215.35	One Globe Bath Light	1
YB6462NL	301.35	Two Globe Bath Light	1
YB6463NL	386.20	Three Globe Bath Light	1
YB6464NL	513.60	Four Globe Bath Light	1
Oil Rubbed Bronze (ORB)			
YB6461ORB	222.30	One Globe Bath Light	1
YB6462ORB	311.00	Two Globe Bath Light	1
YB6463ORB	386.20	Three Globe Bath Light	1
YB6464ORB	494.60	Four Globe Bath Light	1
Matte Black (BL)			
YB6461BL	215.35	One Globe Bath Light	1
YB6462BL	301.35	Two Globe Bath Light	1
YB6463BL	402.10	Three Globe Bath Light	1
YB6464BL	513.60	Four Globe Bath Light	1
Replacement Globe			
YB6469	32.65	Replacement Globe	3



One Globe Bath Light
YB6461



Two Globe Bath Light
YB6462



Three Globe Bath Light
YB6463



Four Globe Bath Light
YB6464









Replacement Globe
YB6469





















Bulbs not included.
List price is per each (unless otherwise noted).
Product can be ordered by case quantity or individually.
All Belfield™ Lighting Fixtures can be mounted facing either upward or downward.









CIA™ Collection











	MODEL	LIST	FINISH/CONNECT	CASE QTY
TOUCHLESS ONE-HANDLE BATHROOM FAUCET - MOTIONSENSE WAVE™				
 <p>DECKPLATE INCLUDED</p> <ul style="list-style-type: none"> • application: one or three hole • supply lines: flexible • connection: 3/8" compression • deckplate: included • drain assembly: metal • drain assembly type: spring loaded pop-up • red/blue markings: included • matte black faucet includes optional brushed gold escutcheon • DC powered: 6 AA batteries included <p> DURALOCK® DURALAST®</p>	<p> 1.2 GPM (4.5L/min) max.</p>			
	6221EW	627.70	Chrome	3
	6221EWBN	847.40	Brushed Nickel	3
	6221EWBL	910.15	Matte Black	3
	6221EWBG	910.15	Brushed Gold	3
OPTIONAL AC ADAPTERS SOLD SEPARATELY				
	169031	156.45	N/A or Unfinished	12







ONE-HANDLE BATHROOM FAUCET				
 <p>DECKPLATE INCLUDED</p> <ul style="list-style-type: none"> • application: one or three hole • supply lines: flexible • connection: 3/8" compression • deckplate: included • drain assembly: metal with lift rod • matte black faucet includes optional brushed gold escutcheon and lift rod • red/blue markings: included <p> DURALAST®</p>	<p> 1.2 GPM (4.5L/min) max.</p>			
	6221	342.10	Chrome	3
	6221BN	461.85	Brushed Nickel	3
	6221BL	496.05	Matte Black	3
	6221BG	496.05	Brushed Gold	3







TWO-HANDLE WIDESPREAD BATHROOM FAUCET TRIM					
 <ul style="list-style-type: none"> • application: three hole • center dimensions: 8" - 16" center • drain assembly: metal with lift rod • matte black faucet includes optional brushed gold escutcheon and lift rod • valve: sold separately <p> </p>	<p> 1.2 GPM (4.5L/min) max.</p>				
	T6222	355.25	Chrome	3	
	T6222BN	532.85	Brushed Nickel	3	
	T6222BL	568.35	Matte Black	3	
	T6222BG	586.15	Brushed Gold	3	
WIDESPREAD FAUCET VALVE					
 <ul style="list-style-type: none"> • application: three hole • center dimensions: 8" - 16" center • drain assembly: metal with lift rod <p> DURALOCK® DURALAST®</p>	9000◆	162.15	1/2" IPS	6	
HOW TO ORDER VALVES: PAGE 463	 TRIM PART #	+	 VALVE PART #	=	 COMPLETE FAUCET























		MODEL	LIST	FINISH/CONNECT	CASE QTY
FREESTANDING TUB FILLER TRIM					
 <ul style="list-style-type: none"> • application: one hole • showerhead type: handshower • handshower functions: one-function • handshower flow rate: 1.75 gpm (6.65 L/min) max. • spout reach: 8.81" • mounting kit: sold separately  		615	1717.85	Chrome	1
		615BN	2319.15	Brushed Nickel	1
		615BG	2319.15	Brushed Gold	1
		615BL	2550.95	Matte Black	1
FREESTANDING TUB FILLER VALVE AND MOUNTING KIT - PREMIUM					
 <ul style="list-style-type: none"> • description: single riser floor joist mounting kit • application: one hole • quarter turn stops: included 		TS50100	400.90	1/2" CC, NPT	2
 <ul style="list-style-type: none"> • description: single riser concrete mounting kit • application: one hole • connection size: 1/2" 		TS50110	325.95	1/2" CC, NPT	2
<p>HOW TO ORDER VALVES: PAGE 463</p>  <p>TRIM PART #</p> <p>+</p>  <p>VALVE PART #</p> <p>=</p>  <p>COMPLETE FAUCET</p>					



















ONE-HANDLE WALLMOUNT TUB FILLER TRIM					
 <ul style="list-style-type: none"> • application: two hole • connection: 1/2" slip fit • tub spout type: non diverter • spout reach: 10.00" • includes: high flow volume control cartridge • WMV130 series valve kit: sold separately  		WT6221	698.75	Chrome	3
		WT6221BN	943.30	Brushed Nickel	3
		WT6221BG	943.30	Brushed Gold	3
		WT6221BL	1037.65	Matte Black	3
ONE-HANDLE WALLMOUNT TUB FILLER VALVE KIT					
 <ul style="list-style-type: none"> • application: two hole with adj. center dimensions • ports: three • quarter turn stops: included • includes: test plug • includes: spout manifold 		WMV130CIS	151.05	1/2" CC/IPS	6
		WMV130XS	151.05	1/2" Crimp Ring PEX	6
		WMV130CXS	151.05	1/2" Cold Exp. PEX	6
<p>HOW TO ORDER VALVES: PAGE 463</p>  <p>TRIM PART #</p> <p>+</p>  <p>VALVE PART #</p> <p>=</p>  <p>COMPLETE FAUCET</p>					

		MODEL	LIST	FINISH/CONNECT	CASE QTY
TWO-HANDLE ROMAN TUB TRIM					
 <ul style="list-style-type: none"> • application: three hole • spout reach: 8.00" • matte black faucet includes optional brushed gold escutcheon • valve: sold separately 		T6223	502.70	Chrome	3
		T6223BN	702.45	Brushed Nickel	3
		T6223BG	702.45	Brushed Gold	3
		T6223BL	772.70	Matte Black	3
TWO-HANDLE ROMAN TUB VALVE					
 <ul style="list-style-type: none"> • deck thickness: 1/8" to 3-3/8" rough-in deck • adjustable spout shank: adjustable center dimensions 		4792	188.55	1/2" CC	6
 <ul style="list-style-type: none"> • deck thickness: 1/8" to 2-3/4" rough-in deck • adjustable spout shank: 10" - 24" center dimensions 		4793	213.55	1/2" CPVC, Crimp Ring PEX	6
		4794	203.60	1/2" Crimp Ring PEX, Cold Exp. PEX	6
 <ul style="list-style-type: none"> • deck thickness: 1/8" to 3-3/16" rough-in deck • Non-adjustable spout shank: 10" center dimensions 		4796	177.65	1/2" CC	6
		4797	181.10	1/2" CPVC, Crimp Ring PEX	6
		4798	181.10	1/2" Crimp Ring PEX, Cold Exp. PEX	6
For more product details, reference page 464 in valve section.					
HOW TO ORDER VALVES: PAGE 464		 TRIM PART # +  VALVE PART # =  COMPLETE FAUCET			











EXACTTEMP® VALVE ONLY TRIM					
 <ul style="list-style-type: none"> • description: temperature control valve trim • requires: separate volume control valve • valve: sold separately 		T4621	291.25	Chrome	3
		T4621BN	439.95	Brushed Nickel	3
		T4621BG	439.95	Brushed Gold	3
		T4621BL	473.40	Matte Black	3
EXACTTEMP® THERMOSTATIC MIXING SHOWER VALVE - PREMIUM					
 <ul style="list-style-type: none"> • description: thermostatic rough-in valve • ports: four with adjustable temp. limit stops • check stops: included 		S3371	714.65	3/4" IPS	6
HOW TO ORDER VALVES: PAGE 465		 TRIM PART # +  VALVE PART # =  COMPLETE FAUCET			











EXACTTEMP® VOLUME CONTROL VALVE TRIM					
 <ul style="list-style-type: none"> • valve: sold separately 		T4622	148.30	Chrome	6
		T4622BN	223.50	Brushed Nickel	6
		T4622BG	223.50	Brushed Gold	6
		T4622BL	241.00	Matte Black	6
EXACTTEMP® VOLUME CONTROL SHOWER VALVE - PREMIUM					
 <ul style="list-style-type: none"> • includes: volume control 		S3600	181.70	3/4" IPS	12
HOW TO ORDER VALVES: PAGE 465		 TRIM PART # +  VALVE PART # =  COMPLETE FAUCET			





















	MODEL	LIST	FINISH/CONNECT	CASE QTY	
M-CORE® 4-SERIES TUB/SHOWER TRIM					
 <ul style="list-style-type: none"> • showerhead functions: one-function • showerhead size: 10" diameter • tub spout length: 7 1/4" • tub spout connection type: slip fit • includes: thermostatic cartridge with volume and temperature control • valve: sold separately 	 1.75 GPM (6.65 L/min) max.				
	UT4363EP	622.85	Chrome	3	
	UT4363EPBN	947.95	Brushed Nickel	3	
	UT4363EPBG	947.95	Brushed Gold	3	
	UT4363EPBL	1029.30	Matte Black	3	
M-CORE® 4-SERIES SHOWER ONLY TRIM					
 <ul style="list-style-type: none"> • showerhead functions: one-function • showerhead size: 10" diameter • includes: thermostatic cartridge with volume and temperature control • valve: sold separately 	 1.75 GPM (6.65 L/min) max.				
	UT4362EP	532.50	Chrome	3	
	UT4362EPBN	802.95	Brushed Nickel	3	
	UT4362EPBG	802.95	Brushed Gold	3	
	UT4362EPBL	869.75	Matte Black	3	
M-CORE® 4-SERIES VALVE ONLY TRIM					
 <ul style="list-style-type: none"> • includes: thermostatic cartridge with volume and temperature control • valve: sold separately 	UT4361	469.00	Chrome	3	
	UT4361BN	683.25	Brushed Nickel	3	
	UT4361BG	683.25	Brushed Gold	3	
	UT4361BL	738.05	Matte Black	3	
	M-CORE® MIXING SHOWER VALVE				
 <ul style="list-style-type: none"> • tub/shower or shower only application • ports: four with adj. temp. limit stops • included: test plug and cross flow plug 	U140CI	71.20	1/2" CC/IPS	6	
	U140X	71.20	1/2" Crimp Ring PEX + CC/IPS Tub	6	
	U140CX	71.20	1/2" Cold Exp. PEX + CC/IPS Tub	6	
	U140V	87.20	1/2" CPVC + CC/IPS Tub	6	
 <ul style="list-style-type: none"> • tub/shower or shower only application • ports: four with adj. temp. limit stops • quarter turn stops: included 	U140CIS	102.45	1/2" CC/IPS	6	
	U140XS	102.45	1/2" Crimp Ring PEX + CC/IPS Tub	6	
	U140CXS	102.45	1/2" Cold Exp. PEX + CC/IPS Tub	6	
	U140VS	118.50	1/2" CPVC + CC/IPS Tub	6	
 <ul style="list-style-type: none"> • tub/shower only application • ports: four with adj. temp. limit stops • tub outlet: pre-fabricated 1/2" copper tube • included: quarter turn stops and plugs 	U140X-PF	80.40	1/2" Crimp Ring PEX	6	
	U140CX-PF	80.40	1/2" Cold Exp. PEX	6	
 <ul style="list-style-type: none"> • tub/shower only application • ports: four with adj. temp. limit stops • tub outlet: pre-fabricated 1/2" copper tube • included: quarter turn stops and plugs 	U140XS-PF	111.70	1/2" Crimp Ring PEX	6	
	U140CXS-PF	111.70	1/2" Cold Exp. PEX	6	
 <ul style="list-style-type: none"> • shower only application • ports: three 	U130CI	71.20	1/2" CC/IPS	6	
	U130X	71.20	1/2" Crimp Ring PEX	6	
	U130CX	71.20	1/2" Cold Exp. PEX	6	
 <ul style="list-style-type: none"> • shower only application • ports: three • quarter turn stops: included 	U130CIS	102.45	1/2" CC/IPS	6	
	U130XS	102.45	1/2" Crimp Ring PEX	6	
	U130CXS	102.45	1/2" Cold Exp. PEX	6	
<p>Four port valves can be used with either Tub/Shower or Shower Only applications. Three port valves can ONLY be used with Shower Only applications. For more product details, reference pages 465-466 in valve section.</p>					
<p>HOW TO ORDER VALVES: PAGES 465-466</p>	 <p>TRIM PART #</p>	+	 <p>VALVE PART #</p>	=	 <p>COMPLETE FAUCET</p>

















		MODEL	LIST	FINISH/CONNECT	CASE QTY
M-CORE® 3-SERIES TUB/SHOWER TRIM					
 <ul style="list-style-type: none"> • showerhead: single-function rainshower • showerhead size: 10" diameter • tub spout length: 7 1/4" • tub spout connection type: slip fit • tub spout type: diverter • includes: pressure balanced cartridge with volume and temperature control • valve: sold separately 		2.5 GPM (9.5 L/min) max.			
		UT3363	487.85	Chrome	3
		UT3363BN	812.95	Brushed Nickel	3
		UT3363BG	812.95	Brushed Gold	3
		UT3363BL	894.30	Matte Black	3
		1.75 GPM (6.65 L/min) max.			
		UT3363EP	487.85	Chrome	3
		UT3363EPBN	812.95	Brushed Nickel	3
		UT3363EPBG	812.95	Brushed Gold	3
		UT3363EPBL	894.30	Matte Black	3
M-CORE® 3-SERIES SHOWER ONLY TRIM					
 <ul style="list-style-type: none"> • showerhead: single-function rainshower • showerhead size: 10" diameter • includes: pressure balanced cartridge with volume and temperature control • valve: sold separately 		2.5 GPM (9.5 L/min) max.			
		UT3362	397.50	Chrome	3
		UT3362BN	667.95	Brushed Nickel	3
		UT3362BG	667.95	Brushed Gold	3
		UT3362BL	734.75	Matte Black	3
		1.75 GPM (6.65 L/min) max.			
		UT3362EP	397.50	Chrome	3
		UT3362EPBN	667.95	Brushed Nickel	3
		UT3362EPBG	667.95	Brushed Gold	3
		UT3362EPBL	734.75	Matte Black	3
M-CORE® 3-SERIES VALVE ONLY TRIM					
 <ul style="list-style-type: none"> • includes: pressure balanced cartridge with volume and temperature control • valve: sold separately 		UT3361	334.00	Chrome	3
		UT3361BN	548.25	Brushed Nickel	3
		UT3361BG	548.25	Brushed Gold	3
		UT3361BL	603.05	Matte Black	3
	M-CORE® MIXING SHOWER VALVE				
 <ul style="list-style-type: none"> • tub/shower or shower only application • ports: four with adj. temp. limit stops • included: test plug and cross flow plug 		U140CI	71.20	1/2" CC/IPS	6
		U140X	71.20	1/2" Crimp Ring PEX + CC/IPS Tub	6
		U140CX	71.20	1/2" Cold Exp. PEX + CC/IPS Tub	6
		U140V	87.20	1/2" CPVC + CC/IPS Tub	6
 <ul style="list-style-type: none"> • tub/shower or shower only application • ports: four with adj. temp. limit stops • quarter turn stops: included 		U140CIS	102.45	1/2" CC/IPS	6
		U140XS	102.45	1/2" Crimp Ring PEX + CC/IPS Tub	6
		U140CXS	102.45	1/2" Cold Exp. PEX + CC/IPS Tub	6
		U140VS	118.50	1/2" CPVC + CC/IPS Tub	6
 <ul style="list-style-type: none"> • tub/shower only application • ports: four with adj. temp. limit stops • tub outlet: pre-fabricated 1/2" copper tube • included: quarter turn stops and plugs 		U140X-PF	80.40	1/2" Crimp Ring PEX	6
		U140CX-PF	80.40	1/2" Cold Exp. PEX	6
 <ul style="list-style-type: none"> • tub/shower only application • ports: four with adj. temp. limit stops • tub outlet: pre-fabricated 1/2" copper tube • included: quarter turn stops and plugs 		U140XS-PF	111.70	1/2" Crimp Ring PEX	6
		U140CXS-PF	111.70	1/2" Cold Exp. PEX	6
 <ul style="list-style-type: none"> • shower only application • ports: three 		U130CI	71.20	1/2" CC/IPS	6
		U130X	71.20	1/2" Crimp Ring PEX	6
		U130CX	71.20	1/2" Cold Exp. PEX	6
 <ul style="list-style-type: none"> • shower only application • ports: three • quarter turn stops: included 		U130CIS	102.45	1/2" CC/IPS	6
		U130XS	102.45	1/2" Crimp Ring PEX	6
		U130CXS	102.45	1/2" Cold Exp. PEX	6
<p>Four port valves can be used with either Tub/Shower or Shower Only applications. Three port valves can ONLY be used with Shower Only applications. For more product details, reference pages 465-466 in valve section.</p>					
<p>HOW TO ORDER VALVES: PAGES 465-466</p>					

CIA™

		MODEL	LIST	FINISH/CONNECT	CASE QTY			
M-CORE® 3-SERIES WITH INTEGRATED TRANSFER VALVE TRIM								
 <ul style="list-style-type: none"> • includes: pressure balanced cartridge with volume and temperature control • valve: sold separately  		UT3331	315.65	Chrome	4			
		UT3331BN	391.30	Brushed Nickel	4			
		UT3331BG	391.30	Brushed Gold	4			
		UT3331BL	430.45	Matte Black	4			
M-CORE® WITH INTEGRATED TRANSFER VALVE								
Three Function (2 independent/1 shared) OR Six Function (3 independent/3 shared) - plumbing configuration page 472								
 <ul style="list-style-type: none"> • ports: four with adj. temp. limit stops • check stops: included 		U362CIS	265.40	1/2" CC/IPS	6			
		U362CXS	265.40	1/2" Cold Exp. PEX	6			
		U362XS	265.40	1/2" Crimp Ring PEX	6			
Two Independent Functions OR Three Independent Functions - plumbing configurations page 472								
 <ul style="list-style-type: none"> • ports: four with adj. temp. limit stops • check stops: included 		U232CIS	265.40	1/2" CC/IPS	6			
		U232CXS	265.40	1/2" Cold Exp. PEX	6			
		U232XS	265.40	1/2" Crimp Ring PEX	6			
For more product details, reference page 466 in valve section. See page 472 for plumbing configurations.								
HOW TO ORDER VALVES: PAGE 466		TRIM PART #	+		VALVE PART #	=		COMPLETE FAUCET

M-CORE® TRANSFER VALVE TRIM								
 <ul style="list-style-type: none"> • use with the M-CORE® transfer valve • valve: sold separately  		UT4620	218.50	Chrome	12			
		UT4620BN	268.95	Brushed Nickel	12			
		UT4620BG	268.95	Brushed Gold	12			
		UT4620BL	288.65	Matte Black	12			
M-CORE® TRANSFER VALVE								
Three Function (2 independent/1 shared) OR Six Function (3 independent/3 shared) - plumbing configuration page 472								
 <ul style="list-style-type: none"> • number of functions: three or six • ports: four 		U361CI	149.70	1/2" CC/IPS	6			
		U361CX	149.70	1/2" Cold Exp. PEX	6			
		U361X	149.70	1/2" Crimp Ring PEX	6			
Two Independent Functions OR Three Independent Functions - plumbing configurations page 472								
 <ul style="list-style-type: none"> • number of functions: two or three • ports: four 		U231CI	149.70	1/2" CC/IPS	6			
		U231CX	149.70	1/2" Cold Exp. PEX	6			
		U231X	149.70	1/2" Crimp Ring PEX	6			
For more product details, reference page 466 in valve section. See page 472 for plumbing configurations.								
HOW TO ORDER VALVES: PAGE 466		TRIM PART #	+		VALVE PART #	=		COMPLETE FAUCET

		MODEL	LIST	FINISH/CONNECT	CASE QTY	
M-CORE® 2-SERIES TUB/SHOWER TRIM						
	<ul style="list-style-type: none"> • showerhead: single-function eco-performance rainshower • showerhead size: 6-3/4" diameter • type of function: one function • tub spout length: 7 1/4" • tub spout connection type: slip fit • tub spout type: diverter • red/blue markings: included • includes: pressure balanced cartridge with temperature control • valve: sold separately 	1.75 GPM (6.65 L/min) max.				
			UT2263EP	392.65	Chrome	4
			UT2263EPBN	614.50	Brushed Nickel	4
			UT2263EPBG	614.50	Brushed Gold	4
			UT2263EPBL	663.85	Matte Black	4
						
M-CORE® 2-SERIES SHOWER ONLY TRIM						
	<ul style="list-style-type: none"> • showerhead: single-function eco-performance rainshower • showerhead size: 6-3/4" diameter • red/blue markings: included • includes: pressure balanced cartridge with temperature control • valve: sold separately 	1.75 GPM (6.65 L/min) max.				
			UT2262EP	334.50	Chrome	4
			UT2262EPBN	509.30	Brushed Nickel	4
			UT2262EPBG	509.30	Brushed Gold	4
			UT2262EPBL	548.15	Matte Black	4
						
M-CORE® 2-SERIES VALVE ONLY TRIM						
	<ul style="list-style-type: none"> • includes: pressure balanced cartridge with temperature control • valve: sold separately 	UT2261	281.20	Chrome	3	
		UT2261BN	411.90	Brushed Nickel	3	
		UT2261BG	411.90	Brushed Gold	3	
		UT2261BL	441.05	Matte Black	3	
						
M-CORE® MIXING SHOWER VALVE						
	<ul style="list-style-type: none"> • tub/shower or shower only application • ports: four with adj. temp. limit stops • included: test plug and cross flow plug 	U140CI	71.20	1/2" CC/IPS	6	
		U140X	71.20	1/2" Crimp Ring PEX + CC/IPS Tub	6	
		U140CX	71.20	1/2" Cold Exp. PEX + CC/IPS Tub	6	
		U140V	87.20	1/2" CPVC + CC/IPS Tub	6	
						
	<ul style="list-style-type: none"> • tub/shower or shower only application • ports: four with adj. temp. limit stops • quarter turn stops: included 	U140CIS	102.45	1/2" CC/IPS	6	
		U140XS	102.45	1/2" Crimp Ring PEX + CC/IPS Tub	6	
		U140CXS	102.45	1/2" Cold Exp. PEX + CC/IPS Tub	6	
		U140VS	118.50	1/2" CPVC + CC/IPS Tub	6	
						
	<ul style="list-style-type: none"> • tub/shower only application • ports: four with adj. temp. limit stops • tub outlet: pre-fabricated 1/2" copper tube • included: quarter turn stops and plugs 	U140X-PF	80.40	1/2" Crimp Ring PEX	6	
		U140CX-PF	80.40	1/2" Cold Exp. PEX	6	
						
	<ul style="list-style-type: none"> • tub/shower only application • ports: four with adj. temp. limit stops • tub outlet: pre-fabricated 1/2" copper tube • included: quarter turn stops and plugs 	U140XS-PF	111.70	1/2" Crimp Ring PEX	6	
		U140CXS-PF	111.70	1/2" Cold Exp. PEX	6	
						
	<ul style="list-style-type: none"> • shower only application • ports: three 	U130CI	71.20	1/2" CC/IPS	6	
		U130X	71.20	1/2" Crimp Ring PEX	6	
		U130CX	71.20	1/2" Cold Exp. PEX	6	
						
	<ul style="list-style-type: none"> • shower only application • ports: three • quarter turn stops: included 	U130CIS	102.45	1/2" CC/IPS	6	
		U130XS	102.45	1/2" Crimp Ring PEX	6	
		U130CXS	102.45	1/2" Cold Exp. PEX	6	
						
<p>Four port valves can be used with either Tub/Shower or Shower Only applications. Three port valves can ONLY be used with Shower Only applications. For more product details, reference pages 465-466 in valve section.</p>						
<p>HOW TO ORDER VALVES: PAGES 465-466</p>		 <p>TRIM PART #</p>	+	 <p>VALVE PART #</p>	=	 <p>COMPLETE FAUCET</p>

		MODEL	LIST	FINISH/CONNECT	CASE QTY	
POSI-TEMP® TUB/SHOWER TRIM						
	<ul style="list-style-type: none"> • showerhead: single-function eco-performance rainshower • showerhead size: 6-3/4" diameter • tub spout length: 7 1/4" • tub spout connection type: slip fit • tub spout type: diverter • red/blue markings: included • valve: sold separately 	🔥 1.75 GPM (6.65 L/min) max.				
		T2263EP	271.60	Chrome	4	
		T2263EPBN	493.50	Brushed Nickel	4	
		T2263EPBG	493.50	Brushed Gold	4	
		T2263EPBL	542.80	Matte Black	4	
						
POSI-TEMP® SHOWER ONLY TRIM						
	<ul style="list-style-type: none"> • showerhead: single-function eco-performance rainshower • showerhead size: 6-3/4" diameter • red/blue markings: included • valve: sold separately 	🔥 1.75 GPM (6.65 L/min) max.				
		T2262EP	213.45	Chrome	4	
		T2262EPBN	388.25	Brushed Nickel	4	
		T2262EPBG	388.25	Brushed Gold	4	
		T2262EPBL	427.10	Matte Black	4	
						
POSI-TEMP® VALVE ONLY TRIM						
	<ul style="list-style-type: none"> • red/blue markings: included • valve: sold separately 	T2261	160.15	Chrome	3	
		T2261BN	290.85	Brushed Nickel	3	
		T2261BG	290.85	Brushed Gold	3	
		T2261BL	320.05	Matte Black	3	
						
POSI-TEMP® SHOWER MIXING VALVES						
	<ul style="list-style-type: none"> • tub/shower or shower only application • ports: four with adjustable temp. limit stops • test plug: included 	2520 ◆	156.10	1/2" CC	6	
			2510 ◆	156.10	1/2" IPS	6
	<ul style="list-style-type: none"> • tub/shower or shower only application • ports: four with adjustable temp. limit stops • quarter turn stops: included • test plug: included 	2570 ◆	189.55	1/2" CC	6	
		2590 ◆	189.55	1/2" IPS	6	
		2580 ◆	156.10	1/2" Crimp ring PEX	6	
						
	<ul style="list-style-type: none"> • tub/shower only application • ports: four with adjustable temp. limit stops • quarter turn stops: included • test plug: included 	2360PF	208.45	1/2" Crimp Ring PEX	3	
			2385PF	208.45	1/2" Cold Exp. PEX	3
	<ul style="list-style-type: none"> • shower only application • ports: three with adjustable temp. limit stops • quarter turn stops: included • test plug: included 	2326PF	201.20	1/2" Crimp Ring PEX	6	
			2328PF	201.20	1/2" Cold Exp. PEX	6
<p>Four port valves can be used with either Tub/Shower or Shower Only applications. Three port valves can ONLY be used with Shower Only applications. For more product details, reference page 467-468 in valve section.</p>						
HOW TO ORDER VALVES: PAGES 467-470		 TRIM PART #	+	 VALVE PART #	=	 COMPLETE FAUCET

Moen® bath accessories CANNOT be combined with Moen faucet parts on a Purchase Order.

COORDINATING ACCESSORIES

Perfectly suited styles for a cohesive look. From robe hooks to towel bars, paper holders to knobs and pulls, Moen offers a variety of coordinating accessories to complete any room.

MODEL NUMBER	LIST EACH	DESCRIPTION	QTY
Chrome (CH)			
YB0402CH	65.55	Swiveling Double Robe Hook	24
YB0403CH	36.25	Single Robe Hook	24
Ⓟ YB0408CH	66.15	Pivoting Paper Holder	6
YB0409CH	56.30	Single-Post Paper Holder	6
YB0418CH	76.80	18" Towel Bar	6
YB0424CH	79.20	24" Towel Bar	6
YB0486CH	53.90	Hand Towel Bar	6

Brushed Nickel (BN)			
YB0402BN	74.65	Swiveling Double Robe Hook	24
YB0403BN	39.90	Single Robe Hook	24
Ⓟ YB0408BN	73.15	Pivoting Paper Holder	6
YB0409BN	61.95	Single-Post Paper Holder	6
YB0418BN	84.45	18" Towel Bar	6
YB0424BN	87.45	24" Towel Bar	6
YB0486BN	58.95	Hand Towel Bar	6

Brushed Gold (BG)			
YB0403BG	47.90	Single Robe Hook	24
Ⓟ YB0408BG	106.10	Pivoting Paper Holder	6
YB0418BG	118.25	18" Towel Bar	6
YB0424BG	122.30	24" Towel Bar	6
YB0486BG	85.45	Hand Towel Bar	6

Matte Black (BL)			
YB0402BL	81.90	Swiveling Double Robe Hook	24
YB0403BL	43.80	Single Robe Hook	24
Ⓟ YB0408BL	80.45	Pivoting Paper Holder	6
YB0409BL	68.10	Single-Post Paper Holder	6
YB0418BL	92.85	18" Towel Bar	6
YB0424BL	96.15	24" Towel Bar	6
YB0486BL	64.85	Hand Towel Bar	6

Ⓟ Denotes pivoting paper holder and mirror

GRAB BARS

MODEL NUMBER	LIST EACH	DESCRIPTION	QTY
1½" • Chrome (CH)			
YG0412CH	128.75	12" Designer Grab Bar	6
YG0418CH	134.50	18" Designer Grab Bar	6
YG0424CH	140.50	24" Designer Grab Bar	6
YG0436CH	159.95	36" Designer Grab Bar	6
YG0442CH	234.70	42" Designer Grab Bar	6

1½" • Brushed Nickel (BN)			
YG0412BN	155.65	12" Designer Grab Bar	6
YG0418BN	163.15	18" Designer Grab Bar	6
YG0424BN	176.05	24" Designer Grab Bar	6
YG0436BN	198.15	36" Designer Grab Bar	6
YG0442BN	293.40	42" Designer Grab Bar	6

1½" • Brushed Gold (BG)			
YG0418BG	195.75	18" Designer Grab Bar	6
YG0424BG	211.20	24" Designer Grab Bar	6

Ⓒ Complies with Americans with Disabilities Act (ADA) specifications. SecureMount™ Grab Bars are tested to withstand 500 lb. pull when securely installed per instructions.



Single Robe Hook
YB0403



Swiveling Double Robe Hook
YB0402



Pivoting Paper Holder
YB0408 | Ⓟ



Single Post Paper Holder
YB0409



Hand Towel Bar
YB0486



18" Towel Bar
YB0418

24" Towel Bar
YB0424





SECUREMOUNT





- SecureMount™ Grab Bars are manufactured with an innovative flange design that makes it easy to connect to the stud at multiple points.
- Tested to withstand 500lbs.
- To install grab bars securely without studs, use SecureMount™ Anchors. Sold separately.









18" Designer Grab Bar
YG0418

List price is per each (unless otherwise noted). Product can be ordered by case quantity or individually. For more information on ordering bath accessories, contact Moen Bath Accessory Customer Service at 800-882-0116, contact your local Moen sales representative, or visit us at www.moen.com.

ONE-HANDLE BATHROOM FAUCET		MODEL	LIST	FINISH/CONNECT	CASE QTY
 DECKPLATE INCLUDED 	<ul style="list-style-type: none"> • application: one or three hole • supply lines: flexible • connection: 3/8" compression • deckplate: included • drain assembly: metal with lift rod  DURALAST®	 1.2 GPM (4.5L/min) max.			
			6903 6903BN 6903BL 6903NL 6903BG 6903ORB	 342.10 461.85 478.95 478.95 496.05 496.05	 Chrome Brushed Nickel Matte Black Polished Nickel Brushed Gold Oil Rubbed Bronze

TWO-HANDLE CENTERSET BATHROOM FAUCET		MODEL	LIST	FINISH/CONNECT	CASE QTY
	<ul style="list-style-type: none"> • application: three hole • center dimensions: 4" center • connection: 1/2" IPS • drain assembly: metal with lift rod  DURALAST®	 1.2 GPM (4.5L/min) max.			
			6901 6901BN 6901BL 6901NL 6901BG 6901ORB	 340.00 459.05 476.05 476.05 493.05 493.05	 Chrome Brushed Nickel Matte Black Polished Nickel Brushed Gold Oil Rubbed Bronze

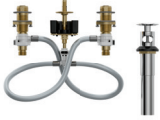
TWO-HANDLE WIDESPREAD BATHROOM FAUCET TRIM		MODEL	LIST	FINISH/CONNECT	CASE QTY
	<ul style="list-style-type: none"> • application: three hole • center dimensions: 8" - 16" center • drain assembly: metal with lift rod • valve: sold separately  	 1.2 GPM (4.5L/min) max.			
			T6905 T6905BN T6905BL T6905NL T6905BG T6905ORB	 355.25 532.85 550.60 550.60 586.15 568.35	 Chrome Brushed Nickel Matte Black Polished Nickel Brushed Gold Oil Rubbed Bronze

WIDESPREAD FAUCET VALVE		MODEL	LIST	FINISH/CONNECT	CASE QTY
	<ul style="list-style-type: none"> • application: three hole • center dimensions: 8" - 16" center • drain assembly: metal with lift rod  DURALOCK® DURALAST®	 1.2 GPM (4.5L/min) max.			
		9000 ◆	162.15	1/2" IPS	6













HOW TO ORDER
VALVES: PAGE 463

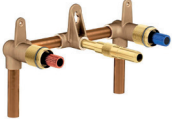











 **TRIM PART #**





 **VALVE PART #**





 **COMPLETE FAUCET**



		MODEL	LIST	FINISH/CONNECT	CASE QTY
TWO-HANDLE WALLMOUNT BATHROOM FAUCET TRIM					
 <ul style="list-style-type: none"> • application: three hole • center dimensions: 8" center • drain assembly: 140780 sold separately • valve: sold separately 	<ul style="list-style-type: none"> • application: three hole • center dimensions: 8" center • drain assembly: 140780 sold separately • includes: mounting brackets 	 1.2 GPM (4.5L/min) max.			
		T6906	404.95	Chrome	3
		T6906BN	587.20	Brushed Nickel	3
		Q3  T6906BL	587.20	Matte Black	3
		T6906NL	607.45	Polished Nickel	3
		T6906BG	647.90	Brushed Gold	3
		T6906ORB	627.70	Oil Rubbed Bronze	3
TWO-HANDLE WALLMOUNT FAUCET VALVE					
	<ul style="list-style-type: none"> • application: three hole • center dimensions: 8" center • drain assembly: 140780 sold separately • includes: mounting brackets 	9700	229.35	1/2" CC	3
HOW TO ORDER VALVES: PAGE 463  TRIM PART #   VALVE PART #   COMPLETE FAUCET					
OPTION: DRAIN ASSEMBLY					
 <ul style="list-style-type: none"> • drain assembly: metal • drain assembly type: spring loaded pop-up • drain assembly size: 1-1/4" • drain assembly: 1-1/4" non-overflow 		140780	76.80	Chrome	12
		140780BN	107.05	Brushed Nickel	12
		140780BL	120.90	Matte Black	12
		140780NL	107.05	Polished Nickel	12
		140780BG	107.05	Brushed Gold	12
		140780ORB	128.75	Oil Rubbed Bronze	12



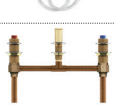



FREESTANDING TUB FILLER TRIM					
 <ul style="list-style-type: none"> • application: one hole • showerhead type: handshower • handshower functions: one-function • handshower flowrate: 1.75 gpm (6.65 L/min) max. • spout reach: 9.75" • mounting kit: sold separately 		695	1874.95	Chrome	1
		695BN	2531.20	Brushed Nickel	1
		695NL	2531.20	Polished Nickel	1
		695BG	2531.20	Brushed Gold	1
		Q3  695BL	2624.95	Matte Black	1
		695ORB	2784.35	Oil Rubbed Bronze	1
	FREESTANDING TUB FILLER VALVE AND MOUNTING KIT - PREMIUM				
 <ul style="list-style-type: none"> • description: single riser floor joist mounting kit • application: one hole • quarter turn stops: included 		TS50100	400.90	1/2" CC, NPT	2
	 <ul style="list-style-type: none"> • description: single riser concrete mounting kit • application: one hole • connection size: 1/2" 		TS50110	325.95	1/2" CC, NPT
HOW TO ORDER VALVES: PAGE 463  TRIM PART #   VALVE PART #   COMPLETE FAUCET					







		MODEL	LIST	FINISH/CONNECT	CASE QTY
ONE-HANDLE WALLMOUNT TUB FILLER TRIM					
 <ul style="list-style-type: none"> • application: two hole • connection: 1/2" slip fit • tub spout type: non diverter • spout reach: 10.00" • includes: high flow volume control cartridge • WMV130 series valve kit: sold separately 		WT691	650.00	Chrome	3
		WT691BN	897.00	Brushed Nickel	3
		WT691NL	897.00	Polished Nickel	3
		WT691BG	897.00	Brushed Gold	3
		WT691BL	943.30	Matte Black	3
		WT691ORB	986.70	Oil Rubbed Bronze	3
ONE-HANDLE WALLMOUNT TUB FILLER VALVE KIT					
 <ul style="list-style-type: none"> • application: two hole with adj. center dimensions • ports: three • quarter turn stops: included • includes: test plug • includes: spout manifold 		WMV130CIS	151.05	1/2" CC/IPS	6
		WMV130XS	151.05	1/2" Crimp Ring PEX	6
		WMV130CXS	151.05	1/2" Cold Exp. PEX	6
<p>HOW TO ORDER VALVES: PAGE 463</p> <p>  TRIM PART # +  VALVE PART # =  COMPLETE FAUCET </p>					









































TWO-HANDLE ROMAN TUB TRIM					
 <ul style="list-style-type: none"> • application: three hole • spout reach: 8.25" • valve: sold separately 		T693	502.70	Chrome	3
		T693BN	702.45	Brushed Nickel	3
		T693NL	702.45	Polished Nickel	3
		T693BG	702.45	Brushed Gold	3
		T693BL	728.95	Matte Black	3
		T693ORB	772.65	Oil Rubbed Bronze	3
TWO-HANDLE ROMAN TUB TRIM WITH HANDSHOWER					
 <ul style="list-style-type: none"> • application: four hole • showerhead type: handshower • handshower flow rate: 1.75 gpm (6.65 L/min) max. • spray functions: one-function • spout reach: 8.25" • valve: sold separately 		T694	783.05	Chrome	3
		T694BN	1289.00	Brushed Nickel	3
		T694NL	1289.00	Polished Nickel	3
		T694BG	1289.00	Brushed Gold	3
		T694BL	1331.15	Matte Black	3
		T694ORB	1417.85	Oil Rubbed Bronze	3
TWO-HANDLE ROMAN TUB VALVE					
 <ul style="list-style-type: none"> • deck thickness: 1/8" to 3-3/8" rough-in deck • adjustable spout shank: adjustable center dimensions 		4792	188.55	1/2" CC	6
	DURALAST®				
	 <ul style="list-style-type: none"> • deck thickness: 1/8" to 2-3/4" rough-in deck • adjustable spout shank: 10" - 24" center dimensions 		4793	213.55	1/2" CPVC, Crimp Ring PEX
		4794	203.60	1/2" Crimp Ring PEX, Cold Exp. PEX	6
DURALOCK® DURALAST®					
 <ul style="list-style-type: none"> • deck thickness: 1/8" to 3-3/16" rough-in deck • Non-adjustable spout shank: 10" center dimensions 		4796	177.65	1/2" CC	6
		4797	181.10	1/2" CPVC, Crimp Ring PEX	6
		4798	181.10	1/2" Crimp Ring PEX, Cold Exp. PEX	6
TWO-HANDLE ROMAN TUB VALVE WITH HANDSHOWER					
 <ul style="list-style-type: none"> • deck thickness: 1/8" to 2-5/8" rough-in deck • non-adj spout shank: adjustable center dim's 		9792	424.85	1/2" CC	6
	DURALAST®				
 <ul style="list-style-type: none"> • deck thickness: 1/8" to 2-5/8" rough-in deck • adj spout shank: 10" - 24" center dimensions 		9793	434.80	1/2" CPVC, Crimp Ring PEX	6
	DURALOCK® DURALAST®				
For more product details, reference page 464 in valve section.					
<p>HOW TO ORDER VALVES: PAGE 464</p> <p>  TRIM PART # +  VALVE PART # =  COMPLETE FAUCET </p>					































VOSS™ Collection

		MODEL	LIST	FINISH/CONNECT	CASE QTY	
EXACTTEMP® VALVE ONLY TRIM						
 <ul style="list-style-type: none"> • description: temperature control valve trim • requires: separate volume control valve • valve: sold separately 		T4691	292.10	Chrome	3	
		T4691BN	439.95	Brushed Nickel	3	
		T4691NL	439.95	Polished Nickel	3	
		T4691BG	439.95	Brushed Gold	3	
	Q3 NEW!	T4691BL	452.70	Matte Black	3	
		T4691ORB	474.55	Oil Rubbed Bronze	3	
EXACTTEMP® THERMOSTATIC MIXING SHOWER VALVE - PREMIUM						
 <ul style="list-style-type: none"> • description: thermostatic rough-in valve • ports: four with adjustable temp. limit stops • check stops: included 		S3371	714.65	¾" IPS	6	
HOW TO ORDER			+		=	
VALVES: PAGE 465		TRIM PART #		VALVE PART #		COMPLETE FAUCET















EXACTTEMP® VOLUME CONTROL VALVE TRIM						
 <ul style="list-style-type: none"> • valve: sold separately 		T4692	148.30	Chrome	6	
		T4692BN	223.50	Brushed Nickel	6	
		T4692NL	223.50	Polished Nickel	6	
		T4692BG	223.50	Brushed Gold	6	
	Q3 NEW!	T4692BL	229.85	Matte Black	6	
		T4692ORB	241.00	Oil Rubbed Bronze	6	
EXACTTEMP® VOLUME CONTROL SHOWER VALVE - PREMIUM						
 <ul style="list-style-type: none"> • includes: volume control 		S3600	181.70	¾" IPS	12	
HOW TO ORDER			+		=	
VALVES: PAGE 465		TRIM PART #		VALVE PART #		COMPLETE FAUCET







		MODEL	LIST	FINISH/CONNECT	CASE QTY	
M-CORE® 4-SERIES TUB/SHOWER TRIM						
  	<ul style="list-style-type: none"> • showerhead: single-function eco-performance rainshower • showerhead size: 6" diameter • tub spout length: 7 15/16" • tub spout connection type: slip fit • tub spout type: diverter • includes: thermostatic cartridge with volume and temperature control • valve: sold separately 	 1.75 GPM (6.65 L/min) max.				
		Q2 	UT4693EP	622.85	Chrome	4
		Q2 	UT4693EPBN	947.95	Brushed Nickel	4
		Q2 	UT4693EPNL	947.95	Polished Nickel	4
		Q2 	UT4693EPBG	947.95	Brushed Gold	4
		Q3 	UT4693EPBL	964.30	Matte Black	4
Q2 	UT4693EPORB	1014.75	Oil Rubbed Bronze	4		
 						
M-CORE® 4-SERIES SHOWER ONLY TRIM						
 	<ul style="list-style-type: none"> • showerhead: single-function eco-performance rainshower • showerhead size: 6" diameter • includes: thermostatic cartridge with volume and temperature control • valve: sold separately 	 1.75 GPM (6.65 L/min) max.				
		Q2 	UT4692EP	532.50	Chrome	4
		Q2 	UT4692EPBN	802.95	Brushed Nickel	4
		Q2 	UT4692EPNL	802.95	Polished Nickel	4
		Q2 	UT4692EPBG	802.95	Brushed Gold	4
		Q3 	UT4692EPBL	810.70	Matte Black	4
Q2 	UT4692EPORB	855.35	Oil Rubbed Bronze	4		
 						
M-CORE® 4-SERIES VALVE ONLY TRIM						
	<ul style="list-style-type: none"> • includes: thermostatic cartridge with volume and temperature control • valve: sold separately 	Q2 	UT4691	469.00	Chrome	3
		Q2 	UT4691BN	683.25	Brushed Nickel	3
		Q2 	UT4691NL	683.25	Polished Nickel	3
		Q2 	UT4691BG	683.25	Brushed Gold	3
		Q3 	UT4691BL	686.10	Matte Black	3
		Q2 	UT4691ORB	723.85	Oil Rubbed Bronze	3
 						
M-CORE® MIXING SHOWER VALVE						
	<ul style="list-style-type: none"> • tub/shower or shower only application • ports: four with adj. temp. limit stops • included: test plug and cross flow plug 		U140CI	71.20	1/2" CC/IPS	6
			U140X	71.20	1/2" Crimp Ring PEX + CC/IPS Tub	6
			U140CX	71.20	1/2" Cold Exp. PEX + CC/IPS Tub	6
			U140V	87.20	1/2" CPVC + CC/IPS Tub	6
	<ul style="list-style-type: none"> • tub/shower or shower only application • ports: four with adj. temp. limit stops • quarter turn stops: included 		U140CIS	102.45	1/2" CC/IPS	6
			U140XS	102.45	1/2" Crimp Ring PEX + CC/IPS Tub	6
			U140CXS	102.45	1/2" Cold Exp. PEX + CC/IPS Tub	6
			U140VS	118.50	1/2" CPVC + CC/IPS Tub	6
	<ul style="list-style-type: none"> • tub/shower only application • ports: four with adj. temp. limit stops • tub outlet: pre-fabricated 1/2" copper tube • included: quarter turn stops and plugs 		U140X-PF	80.40	1/2" Crimp Ring PEX	6
			U140CX-PF	80.40	1/2" Cold Exp. PEX	6
	<ul style="list-style-type: none"> • tub/shower only application • ports: four with adj. temp. limit stops • tub outlet: pre-fabricated 1/2" copper tube • included: quarter turn stops and plugs 		U140XS-PF	111.70	1/2" Crimp Ring PEX	6
			U140CXS-PF	111.70	1/2" Cold Exp. PEX	6
	<ul style="list-style-type: none"> • shower only application • ports: three 		U130CI	71.20	1/2" CC/IPS	6
			U130X	71.20	1/2" Crimp Ring PEX	6
			U130CX	71.20	1/2" Cold Exp. PEX	6
	<ul style="list-style-type: none"> • shower only application • ports: three • quarter turn stops: included 		U130CIS	102.45	1/2" CC/IPS	6
			U130XS	102.45	1/2" Crimp Ring PEX	6
			U130CXS	102.45	1/2" Cold Exp. PEX	6
<p>Four port valves can be used with either Tub/Shower or Shower Only applications. Three port valves can ONLY be used with Shower Only applications. For more product details, reference pages 465-466 in valve section.</p>						
HOW TO ORDER VALVES: PAGES 465-466		 TRIM PART #	+	 VALVE PART #	=	 COMPLETE FAUCET



		MODEL	LIST	FINISH/CONNECT	CASE QTY	
M-CORE® 3-SERIES TUB/SHOWER TRIM						
 <ul style="list-style-type: none"> • showerhead: single-function rainshower • showerhead size: 6" diameter • tub spout length: 7 15/16" • tub spout connection type: slip fit • tub spout type: diverter • includes: pressure balanced cartridge with volume and temperature control • valve: sold separately 	<ul style="list-style-type: none"> • showerhead: single-function rainshower • showerhead size: 6" diameter • includes: pressure balanced cartridge with volume and temperature control • valve: sold separately 	2.5 GPM (9.5 L/min) max.				
		Q3 	UT3693	487.85	Chrome	4
			UT3693BN	812.95	Brushed Nickel	4
			UT3693NL	812.95	Polished Nickel	4
			UT3693BG	812.95	Brushed Gold	4
			UT3693BL	829.30	Matte Black	4
			UT3693ORB	879.75	Oil Rubbed Bronze	4
		1.75 GPM (6.65 L/min) max.				
		Q3 	UT3693EP	487.85	Chrome	4
			UT3693EPBN	812.95	Brushed Nickel	4
			UT3693EPNL	812.95	Polished Nickel	4
			UT3693EPBG	812.95	Brushed Gold	4
			UT3693EPBL	829.30	Matte Black	4
			UT3693EPORB	879.75	Oil Rubbed Bronze	4
M-CORE® 3-SERIES SHOWER ONLY TRIM						
 <ul style="list-style-type: none"> • showerhead: single-function rainshower • showerhead size: 6" diameter • includes: pressure balanced cartridge with volume and temperature control • valve: sold separately 	<ul style="list-style-type: none"> • showerhead: single-function rainshower • showerhead size: 6" diameter • includes: pressure balanced cartridge with volume and temperature control • valve: sold separately 	2.5 GPM (9.5 L/min) max.				
		Q3 	UT3692	397.50	Chrome	4
			UT3692BN	667.95	Brushed Nickel	4
			UT3692NL	667.95	Polished Nickel	4
			UT3692BG	667.95	Brushed Gold	4
			UT3692BL	675.70	Matte Black	4
			UT3692ORB	720.35	Oil Rubbed Bronze	4
		1.75 GPM (6.65 L/min) max.				
		Q3 	UT3692EP	397.50	Chrome	4
			UT3692EPBN	667.95	Brushed Nickel	4
			UT3692EPNL	667.95	Polished Nickel	4
			UT3692EPBG	667.95	Brushed Gold	4
			UT3692EPBL	675.70	Matte Black	4
			UT3692EPORB	720.35	Oil Rubbed Bronze	4
M-CORE® MIXING SHOWER VALVE						
 <ul style="list-style-type: none"> • tub/shower or shower only application • ports: four with adj. temp. limit stops • included: test plug and cross flow plug 	<ul style="list-style-type: none"> • tub/shower or shower only application • ports: four with adj. temp. limit stops • quarter turn stops: included 	U140CI	71.20	1/2" CC/IPS	6	
		U140X	71.20	1/2" Crimp Ring PEX + CC/IPS Tub	6	
		U140CX	71.20	1/2" Cold Exp. PEX + CC/IPS Tub	6	
		U140V	87.20	1/2" CPVC + CC/IPS Tub	6	
 <ul style="list-style-type: none"> • tub/shower or shower only application • ports: four with adj. temp. limit stops • quarter turn stops: included 	<ul style="list-style-type: none"> • tub/shower only application • ports: four with adj. temp. limit stops • tub outlet: pre-fabricated 1/2" copper tube • included: quarter turn stops and plugs 	U140CIS	102.45	1/2" CC/IPS	6	
		U140XS	102.45	1/2" Crimp Ring PEX + CC/IPS Tub	6	
		U140CXS	102.45	1/2" Cold Exp. PEX + CC/IPS Tub	6	
		U140VS	118.50	1/2" CPVC + CC/IPS Tub	6	
 <ul style="list-style-type: none"> • tub/shower only application • ports: four with adj. temp. limit stops • tub outlet: pre-fabricated 1/2" copper tube • included: quarter turn stops and plugs 	<ul style="list-style-type: none"> • tub/shower only application • ports: four with adj. temp. limit stops • tub outlet: pre-fabricated 1/2" copper tube • included: quarter turn stops and plugs 	U140X-PF	80.40	1/2" Crimp Ring PEX	6	
		U140CX-PF	80.40	1/2" Cold Exp. PEX	6	
 <ul style="list-style-type: none"> • shower only application • ports: three 	<ul style="list-style-type: none"> • shower only application • ports: three • quarter turn stops: included 	U130CI	71.20	1/2" CC/IPS	6	
		U130X	71.20	1/2" Crimp Ring PEX	6	
		U130CX	71.20	1/2" Cold Exp. PEX	6	
 <ul style="list-style-type: none"> • shower only application • ports: three • quarter turn stops: included 	<ul style="list-style-type: none"> • shower only application • ports: three • quarter turn stops: included 	U130CIS	102.45	1/2" CC/IPS	6	
		U130XS	102.45	1/2" Crimp Ring PEX	6	
		U130CXS	102.45	1/2" Cold Exp. PEX	6	
<p>Four port valves can be used with either Tub/Shower or Shower Only applications. Three port valves can ONLY be used with Shower Only applications. For more product details, reference pages 465-466 in valve section.</p>						
<p>HOW TO ORDER VALVES: PAGES 465-466</p>		 <p>TRIM PART #</p>	+	 <p>VALVE PART #</p>	=	 <p>COMPLETE FAUCET</p>











VOSS™











		MODEL	LIST	FINISH/CONNECT	CASE QTY
M-CORE® 3-SERIES VALVE ONLY TRIM					
 <ul style="list-style-type: none"> includes: pressure balanced cartridge with volume and temperature control valve: sold separately 		UT3691	334.00	Chrome	3
		UT3691BN	548.25	Brushed Nickel	3
		UT3691NL	548.25	Polished Nickel	3
		UT3691BG	548.25	Brushed Gold	3
		Q3 NEW! UT3691BL	551.10	Matte Black	3
		UT3691ORB	588.85	Oil Rubbed Bronze	3
M-CORE® MIXING SHOWER VALVE					
 <ul style="list-style-type: none"> tub/shower or shower only application ports: four with adj. temp. limit stops included: test plug and cross flow plug 		U140CI	71.20	1/2" CC/IPS	6
		U140X	71.20	1/2" Crimp Ring PEX + CC/IPS Tub	6
		U140CX	71.20	1/2" Cold Exp. PEX + CC/IPS Tub	6
		U140V	87.20	1/2" CPVC + CC/IPS Tub	6
 <ul style="list-style-type: none"> tub/shower or shower only application ports: four with adj. temp. limit stops quarter turn stops: included 		U140CIS	102.45	1/2" CC/IPS	6
		U140XS	102.45	1/2" Crimp Ring PEX + CC/IPS Tub	6
		U140CXS	102.45	1/2" Cold Exp. PEX + CC/IPS Tub	6
		U140VS	118.50	1/2" CPVC + CC/IPS Tub	6
 <ul style="list-style-type: none"> tub/shower only application ports: four with adj. temp. limit stops tub outlet: pre-fabricated 1/2" copper tube included: quarter turn stops and plugs 		U140X-PF	80.40	1/2" Crimp Ring PEX	6
		U140CX-PF	80.40	1/2" Cold Exp. PEX	6
 <ul style="list-style-type: none"> tub/shower only application ports: four with adj. temp. limit stops tub outlet: pre-fabricated 1/2" copper tube included: quarter turn stops and plugs 		U140XS-PF	111.70	1/2" Crimp Ring PEX	6
		U140CXS-PF	111.70	1/2" Cold Exp. PEX	6
 <ul style="list-style-type: none"> shower only application ports: three 		U130CI	71.20	1/2" CC/IPS	6
		U130X	71.20	1/2" Crimp Ring PEX	6
		U130CX	71.20	1/2" Cold Exp. PEX	6
 <ul style="list-style-type: none"> shower only application ports: three quarter turn stops: included 		U130CIS	102.45	1/2" CC/IPS	6
		U130XS	102.45	1/2" Crimp Ring PEX	6
		U130CXS	102.45	1/2" Cold Exp. PEX	6
Four port valves can be used with either Tub/Shower or Shower Only applications. Three port valves can ONLY be used with Shower Only applications. For more product details, reference pages 465-466 in valve section.					
HOW TO ORDER VALVES: PAGES 465-466					

M-CORE® 3-SERIES WITH INTEGRATED TRANSFER VALVE TRIM					
 <ul style="list-style-type: none"> includes: pressure balanced cartridge with volume and temperature control valve: sold separately 		UT3611	315.60	Chrome	4
		UT3611BN	391.30	Brushed Nickel	4
		UT3611NL	391.30	Polished Nickel	4
		UT3611BG	391.30	Brushed Gold	4
		Q3 NEW! UT3611BL	410.30	Matte Black	4
		UT3611ORB	420.95	Oil Rubbed Bronze	4
M-CORE® WITH INTEGRATED TRANSFER VALVE					
Three Function (2 independent/1 shared) OR Six Function (3 independent/3 shared) - plumbing configuration page 472					
 <ul style="list-style-type: none"> ports: four with adj. temp. limit stops check stops: included 		U362CIS	265.40	1/2" CC/IPS	6
		U362CXS	265.40	1/2" Cold Exp. PEX	6
		U362XS	265.40	1/2" Crimp Ring PEX	6
Two Independent Functions OR Three Independent Functions - plumbing configurations page 472					
 <ul style="list-style-type: none"> ports: four with adj. temp. limit stops check stops: included 		U232CIS	265.40	1/2" CC/IPS	6
		U232CXS	265.40	1/2" Cold Exp. PEX	6
		U232XS	265.40	1/2" Crimp Ring PEX	6
For more product details, reference page 466 in valve section. See page 472 for plumbing configurations.					
HOW TO ORDER VALVES: PAGE 466					



















VOSS™ Collection















		MODEL	LIST	FINISH/CONNECT	CASE QTY
M-CORE® TRANSFER VALVE TRIM					
 <ul style="list-style-type: none"> • use with the M-CORE® transfer valve • valve: sold separately 		UT4611	218.50	Chrome	12
		UT4611BN	268.95	Brushed Nickel	12
		UT4611NL	268.95	Polished Nickel	12
		UT4611BG	268.95	Brushed Gold	12
	Q3 	UT4611BL	284.05	Matte Black	12
		UT4611ORB	288.65	Oil Rubbed Bronze	12
M-CORE® TRANSFER VALVE					
Three Function (2 independent/1 shared) OR Six Function (3 independent/3 shared) - plumbing configuration page 472					
 <ul style="list-style-type: none"> • number of functions: three or six • ports: four 		U361CI	149.70	1/2" CC/IPS	6
		U361CX	149.70	1/2" Cold Exp. PEX	6
		U361X	149.70	1/2" Crimp Ring PEX	6
Two Independent Functions OR Three Independent Functions - plumbing configurations page 472					
 <ul style="list-style-type: none"> • number of functions: two or three • ports: four 		U231CI	149.70	1/2" CC/IPS	6
		U231CX	149.70	1/2" Cold Exp. PEX	6
		U231X	149.70	1/2" Crimp Ring PEX	6
For more product details, reference page 466 in valve section. See page 472 for plumbing configurations.					
HOW TO ORDER VALVES: PAGE 466	 TRIM PART #	+	 VALVE PART #	=	 COMPLETE FAUCET















		MODEL	LIST	FINISH/CONNECT	CASE QTY
M-CORE® 2-SERIES TUB/SHOWER TRIM					
 <ul style="list-style-type: none"> • showerhead: single-function eco-performance • showerhead size: 4-1/16" diameter • tub spout length: 7 15/16" • tub spout connection type: slip fit • tub spout type: diverter • includes: pressure balanced cartridge with temperature control • valve: sold separately 	<ul style="list-style-type: none"> • 1.75 GPM (6.65 L/min) max. 	UT2693EP	392.65	Chrome	3
		UT2693EPBN	614.50	Brushed Nickel	3
		UT2693EPNL	614.50	Polished Nickel	3
		UT2693EPBG	614.50	Brushed Gold	3
		Q3 NEW! UT2693EPBL	628.25	Matte Black	3
		UT2693EPORB	664.15	Oil Rubbed Bronze	3
M-CORE® 2-SERIES SHOWER ONLY TRIM					
 <ul style="list-style-type: none"> • showerhead: single-function eco-performance • showerhead size: 4-1/16" diameter • includes: pressure balanced cartridge with temperature control • valve: sold separately 	<ul style="list-style-type: none"> • 1.75 GPM (6.65 L/min) max. 	UT2692EP	334.50	Chrome	12
		UT2692EPBN	509.30	Brushed Nickel	12
		UT2692EPNL	509.30	Polished Nickel	12
		UT2692EPBG	509.30	Brushed Gold	12
		Q3 NEW! UT2692EPBL	518.45	Matte Black	12
		UT2692EPORB	548.05	Oil Rubbed Bronze	12
M-CORE® 2-SERIES VALVE ONLY TRIM					
 <ul style="list-style-type: none"> • includes: pressure balanced cartridge with temperature control • valve: sold separately 	<ul style="list-style-type: none"> • 1.75 GPM (6.65 L/min) max. 	UT2691	281.20	Chrome	3
		UT2691BN	411.90	Brushed Nickel	3
		UT2691NL	411.90	Polished Nickel	3
		UT2691BG	411.90	Brushed Gold	3
		Q3 NEW! UT2691BL	421.85	Matte Black	3
		UT2691ORB	441.05	Oil Rubbed Bronze	3
M-CORE® MIXING SHOWER VALVE					
 <ul style="list-style-type: none"> • tub/shower or shower only application • ports: four with adj. temp. limit stops • included: test plug and cross flow plug 	<ul style="list-style-type: none"> • 1.75 GPM (6.65 L/min) max. 	U140CI	71.20	1/2" CC/IPS	6
		U140X	71.20	1/2" Crimp Ring PEX + CC/IPS Tub	6
		U140CX	71.20	1/2" Cold Exp. PEX + CC/IPS Tub	6
		U140V	87.20	1/2" CPVC + CC/IPS Tub	6
 <ul style="list-style-type: none"> • tub/shower or shower only application • ports: four with adj. temp. limit stops • quarter turn stops: included 	<ul style="list-style-type: none"> • 1.75 GPM (6.65 L/min) max. 	U140CIS	102.45	1/2" CC/IPS	6
		U140XS	102.45	1/2" Crimp Ring PEX + CC/IPS Tub	6
		U140CXS	102.45	1/2" Cold Exp. PEX + CC/IPS Tub	6
		U140VS	118.50	1/2" CPVC + CC/IPS Tub	6
 <ul style="list-style-type: none"> • tub/shower only application • ports: four with adj. temp. limit stops • tub outlet: pre-fabricated 1/2" copper tube • included: quarter turn stops and plugs 	<ul style="list-style-type: none"> • 1.75 GPM (6.65 L/min) max. 	U140X-PF	80.40	1/2" Crimp Ring PEX	6
		U140CX-PF	80.40	1/2" Cold Exp. PEX	6
 <ul style="list-style-type: none"> • tub/shower only application • ports: four with adj. temp. limit stops • tub outlet: pre-fabricated 1/2" copper tube • included: quarter turn stops and plugs 	<ul style="list-style-type: none"> • 1.75 GPM (6.65 L/min) max. 	U140XS-PF	111.70	1/2" Crimp Ring PEX	6
		U140CXS-PF	111.70	1/2" Cold Exp. PEX	6
 <ul style="list-style-type: none"> • shower only application • ports: three 	<ul style="list-style-type: none"> • 1.75 GPM (6.65 L/min) max. 	U130CI	71.20	1/2" CC/IPS	6
		U130X	71.20	1/2" Crimp Ring PEX	6
		U130CX	71.20	1/2" Cold Exp. PEX	6
 <ul style="list-style-type: none"> • shower only application • ports: three • quarter turn stops: included 	<ul style="list-style-type: none"> • 1.75 GPM (6.65 L/min) max. 	U130CIS	102.45	1/2" CC/IPS	6
		U130XS	102.45	1/2" Crimp Ring PEX	6
		U130CXS	102.45	1/2" Cold Exp. PEX	6
<p>Four port valves can be used with either Tub/Shower or Shower Only applications. Three port valves can ONLY be used with Shower Only applications. For more product details, reference pages 465-466 in valve section.</p>					
HOW TO ORDER VALVES: PAGES 465-466					



		MODEL	LIST	FINISH/CONNECT	CASE QTY																		
POSI-TEMP® TUB/SHOWER TRIM																							
 <ul style="list-style-type: none"> • showerhead: single-function standard • showerhead size: 4-1/16" diameter • tub spout length: 7 15/16" • tub spout connection type: slip fit • tub spout type: diverter • valve: sold separately 		2.5 GPM (9.5 L/min) max. T2693 T2693BN T2693NL T2693BG T2693BL T2693ORB 1.75 GPM (6.65 L/min) max. T2693EP T2693EPBN T2693EPNL T2693EPBG T2693EPBL T2693EPORB	271.60 493.50 493.50 493.50 502.45 543.10 271.60 493.50 493.50 493.50 502.45 543.10	Chrome Brushed Nickel Polished Nickel Brushed Gold Matte Black Oil Rubbed Bronze Chrome Brushed Nickel Polished Nickel Brushed Gold Matte Black Oil Rubbed Bronze	3 3 3 3 3 3 3 3 3 3 3																		
						 <ul style="list-style-type: none"> • showerhead type: showerhead sold separately • tub spout length: 7 15/16" • tub spout connection type: slip fit • tub spout type: diverter • valve: sold separately 		T2693NH T2693NHBN	182.90 357.60	Chrome Brushed Nickel	3 3												
												POSI-TEMP® SHOWER ONLY TRIM											
						 <ul style="list-style-type: none"> • showerhead: single-function standard • showerhead size: 4-1/16" diameter • valve: sold separately 		2.5 GPM (9.5 L/min) max. T2692 T2692BN T2692NL T2692BG T2692BL T2692ORB 1.75 GPM (6.65 L/min) max. T2692EP T2692EPBN T2692EPNL T2692EPBG T2692EPBL T2692EPORB	213.45 388.25 388.25 388.25 394.85 427.00 213.45 388.25 388.25 388.25 394.85 427.00	Chrome Brushed Nickel Polished Nickel Brushed Gold Matte Black Oil Rubbed Bronze Chrome Brushed Nickel Polished Nickel Brushed Gold Matte Black Oil Rubbed Bronze	3 3 3 3 3 3 3 3 3 3 3												
												 <ul style="list-style-type: none"> • showerhead type: showerhead sold separately • valve: sold separately 		T2692NH T2692NHBN	169.80 308.40	Chrome Brushed Nickel	3 3						
																		POSI-TEMP® SHOWER MIXING VALVES					
												 <ul style="list-style-type: none"> • tub/shower or shower only application • ports: four with adjustable temp. limit stops • test plug: included 		2520 ♦ 2510 ♦	156.10 156.10	1/2" CC 1/2" IPS	6 6						
																		 <ul style="list-style-type: none"> • tub/shower or shower only application • ports: four with adjustable temp. limit stops • quarter turn stops: included • test plug: included 		2570 ♦ 2590 ♦ 2580 ♦	189.55 189.55 156.10	1/2" CC 1/2" IPS 1/2" Crimp ring PEX	6 6 6
												 <ul style="list-style-type: none"> • tub/shower only application • ports: four with adjustable temp. limit stops • quarter turn stops: included • test plug: included 		2360PF 2385PF	208.45 208.45	1/2" Crimp Ring PEX 1/2" Cold Exp. PEX	3 3						
												Four port valves can be used with either Tub/Shower or Shower Only applications. Three port valves can ONLY be used with Shower Only applications. For more product details, reference page 467-468 in valve section.											
												HOW TO ORDER VALVES: PAGES 467-470		 TRIM PART #	+	 VALVE PART #	=	 COMPLETE FAUCET					

VOSS™

		MODEL	LIST	FINISH/CONNECT	CASE QTY	
POSI-TEMP® VALVE ONLY TRIM						
 <ul style="list-style-type: none"> valve: sold separately 	 	T2691	160.15	Chrome	3	
		T2691BN	290.85	Brushed Nickel	3	
		T2691NL	290.85	Polished Nickel	3	
		T2691BG	290.85	Brushed Gold	3	
		Q3 NEW! T2691BL	296.30	Matte Black	3	
		T2691ORB	320.05	Oil Rubbed Bronze	3	
POSI-TEMP® SHOWER MIXING VALVES						
 <ul style="list-style-type: none"> tub/shower or shower only application ports: four with adjustable temp. limit stops test plug: included 		2520 ◆	156.10	1/2" CC	6	
		2510 ◆	156.10	1/2" IPS	6	
 <ul style="list-style-type: none"> tub/shower or shower only application ports: four with adjustable temp. limit stops quarter turn stops: included test plug: included 		2570 ◆	189.55	1/2" CC	6	
		2590 ◆	189.55	1/2" IPS	6	
		2580 ◆	156.10	1/2" Crimp ring PEX	6	
 <ul style="list-style-type: none"> tub/shower only application ports: four with adjustable temp. limit stops quarter turn stops: included test plug: included 		2360PF	208.45	1/2" Crimp Ring PEX	3	
		2385PF	208.45	1/2" Cold Exp. PEX	3	
 <ul style="list-style-type: none"> shower only application ports: three with adjustable temp. limit stops quarter turn stops: included test plug: included 		2326PF	201.20	1/2" Crimp Ring PEX	6	
		2328PF	201.20	1/2" Cold Exp. PEX	6	
<p>Four port valves can be used with either Tub/Shower or Shower Only applications. Three port valves can ONLY be used with Shower Only applications. For more product details, reference page 467-468 in valve section.</p>						
HOW TO ORDER VALVES: PAGES 467-470		 TRIM PART #	+	 VALVE PART #	=	 COMPLETE FAUCET

POSI-TEMP® WITH INTEGRATED TRANSFER VALVE TRIM						
 <ul style="list-style-type: none"> valve: sold separately 	 	T2690	289.20	Chrome	4	
		T2690BN	525.10	Brushed Nickel	4	
		T2690NL	525.10	Polished Nickel	4	
		T2690BG	525.10	Brushed Gold	4	
		Q3 NEW! T2690BL	534.95	Matte Black	4	
		T2690ORB	577.60	Oil Rubbed Bronze	4	
POSI-TEMP® WITH INTEGRATED TRANSFER VALVE						
 <ul style="list-style-type: none"> functions: three (two independent and one shared) ports: four with adjustable temp. limit stops test plug: included 		2551	281.85	1/2" IPS	6	
		 <ul style="list-style-type: none"> functions: three (two independent and one shared) ports: four with adjustable temp. limit stops stops: included test plug: included 		2581	317.40	1/2" IPS
 <ul style="list-style-type: none"> functions: two independent ports: four with adjustable temp. limit stops test plug: included 				2521	281.85	1/2" IPS
		 <ul style="list-style-type: none"> functions: two independent ports: four with adjustable temp. limit stops stops: included test plug: included 		2571	317.40	1/2" IPS
<p>For more product details, reference page 471 in valve section.</p>						
HOW TO ORDER VALVES: PAGE 471		 TRIM PART #	+	 VALVE PART #	=	 COMPLETE FAUCET



Moen® bath accessories CANNOT be combined with Moen faucet parts on a Purchase Order.

A PERFECT MATCH

A line of perfectly matching accessories - including tank levers and towel bars - allow for a completely cohesive look in the bath.

MODEL NUMBER	LIST EACH	DESCRIPTION	QTY
Chrome (CH)			
YB5101CH	45.20	Tank Lever	24
YB5103CH	34.80	Double Robe Hook	24
Ⓢ YB5108CH	63.50	Pivoting Paper Holder	6
YB5118CH	73.65	18" Towel Bar	6
YB5124CH	76.05	24" Towel Bar	6
YB5186CH	51.70	Towel Ring	6
Brushed Nickel (BN)			
YB5101BN	49.90	Tank Lever	24
YB5103BN	38.30	Double Robe Hook	24
Ⓢ YB5108BN	70.25	Pivoting Paper Holder	6
YB5118BN	81.05	18" Towel Bar	6
YB5124BN	83.90	24" Towel Bar	6
YB5186BN	56.60	Towel Ring	6
Matte Black (BL)			
YB5101BL	54.80	Tank Lever	24 NEW! Q3
YB5103BL	42.00	Double Robe Hook	24 NEW! Q3
Ⓢ YB5108BL	77.35	Pivoting Paper Holder	6 NEW! Q3
YB5118BL	89.10	18" Towel Bar	6 NEW! Q3
YB5124BL	92.40	24" Towel Bar	6 NEW! Q3
YB5186BL	61.65	Towel Ring	6 NEW! Q3
Polished Nickel (NL)			
YB5101NL	54.70	Tank Lever	24
YB5103NL	42.05	Double Robe Hook	24
Ⓢ YB5108NL	82.60	Pivoting Paper Holder	6
YB5118NL	89.25	18" Towel Bar	6
YB5124NL	94.25	24" Towel Bar	6
YB5186NL	62.70	Towel Ring	6
Brushed Gold (BG)			
YB5101BG	59.85	Tank Lever	24
YB5103BG	45.95	Double Robe Hook	24
Ⓢ YB5108BG	101.85	Pivoting Paper Holder	6
YB5118BG	113.45	18" Towel Bar	6
YB5124BG	117.40	24" Towel Bar	6
YB5186BG	81.95	Towel Ring	6
Oil Rubbed Bronze (ORB)			
YB5101ORB	54.80	Tank Lever	24
YB5103ORB	38.90	Double Robe Hook	24
Ⓢ YB5108ORB	71.60	Pivoting Paper Holder	6
YB5118ORB	82.50	18" Towel Bar	6
YB5124ORB	92.40	24" Towel Bar	6
YB5186ORB	57.65	Towel Ring	6

Ⓢ Denotes pivoting paper holder



Tank Lever
YB5101



Double Robe Hook
YB5103



Towel Ring
YB5186



Pivoting Paper Holder
YB5108 | Ⓢ



18" Towel Bar
YB5118

24" Towel Bar
YB5124



GRAB BARS ♿

MODEL NUMBER	LIST EACH	DESCRIPTION	QTY
1 1/4" • Chrome (CH)			
YG5112CH	123.55	12" Designer Grab Bar	6
YG5118CH	129.10	18" Designer Grab Bar	6
YG5124CH	134.90	24" Designer Grab Bar	6
1 1/4" • Brushed Nickel (BN)			
YG5112BN	149.35	12" Designer Grab Bar	6
YG5118BN	156.60	18" Designer Grab Bar	6
YG5124BN	168.95	24" Designer Grab Bar	6
1 1/4" • Matte Black (BL)			
YG5112BL	164.20	12" Designer Grab Bar	6 NEW! Q3
YG5118BL	172.30	18" Designer Grab Bar	6 NEW! Q3
YG5124BL	185.90	24" Designer Grab Bar	6 NEW! Q3
1 1/4" • Polished Nickel (NL)			
YG5112NL	166.60	12" Designer Grab Bar	6
YG5118NL	180.50	18" Designer Grab Bar	6
YG5124NL	202.00	24" Designer Grab Bar	6
1 1/4" • Brushed Gold (BG)			
YG5112BG	179.15	12" Designer Grab Bar	6
YG5118BG	187.85	18" Designer Grab Bar	6
YG5124BG	202.65	24" Designer Grab Bar	6
1 1/4" • Oil Rubbed Bronze (ORB)			
YG5112ORB	164.20	12" Designer Grab Bar	6
YG5118ORB	172.30	18" Designer Grab Bar	6
YG5124ORB	185.90	24" Designer Grab Bar	6

SECUREMOUNT™

- SecureMount™ Grab Bars are manufactured with an innovative flange design that makes it easy to connect to the stud at multiple points.
- Tested to withstand 500lbs.
- To install grab bars securely without studs, use SecureMount™ Anchors. Sold separately.



18" Designer Grab Bar

YG5118

♿ Complies with Americans with Disabilities Act (ADA) specifications. SecureMount™ Grab Bars are tested to withstand 500 lb. pull when securely installed per instructions.

List price is per each (unless otherwise noted). Product can be ordered by case quantity or individually.





LIGHTING

MODEL NUMBER	LIST EACH	DESCRIPTION	QTY
Chrome (CH)			
YB5161CH	177.10	One Globe Bath Light	2
YB5162CH	247.80	Two Globe Bath Light	2
YB5163CH	307.80	Three Globe Bath Light	2
YB5164CH	394.10	Four Globe Bath Light	2
Brushed Nickel (BN)			
YB5161BN	221.45	One Globe Bath Light	2
YB5162BN	309.75	Two Globe Bath Light	2
YB5163BN	384.70	Three Globe Bath Light	2
YB5164BN	492.65	Four Globe Bath Light	2
Matte Black (BL)			
YB5161BL	221.45	One Globe Bath Light	2 NEW! Q3
YB5162BL	309.75	Two Globe Bath Light	2 NEW! Q3
YB5163BL	384.70	Three Globe Bath Light	2 NEW! Q3
YB5164BL	492.65	Four Globe Bath Light	2 NEW! Q3
Polished Nickel (NL)			
YB5161NL	221.55	One Globe Bath Light	2
YB5162NL	322.55	Two Globe Bath Light	2
YB5163NL	415.90	Three Globe Bath Light	2
YB5164NL	532.65	Four Globe Bath Light	2
Brushed Gold (BG)			
YB5161BG	265.80	One Globe Bath Light	2
YB5162BG	371.70	Two Globe Bath Light	2
YB5163BG	461.70	Three Globe Bath Light	2
YB5164BG	591.15	Four Globe Bath Light	2
Oil Rubbed Bronze (ORB)			
YB5161ORB	221.45	One Globe Bath Light	2
YB5162ORB	309.75	Two Globe Bath Light	2
YB5163ORB	384.70	Three Globe Bath Light	2
YB5164ORB	492.65	Four Globe Bath Light	2
Replacement Globe			
YB5169	32.45	Replacement Globe	3



One Globe Bath Light
YB5161



Two Globe Bath Light
YB5162



Three Globe Bath Light
YB5163



Four Globe Bath Light
YB5164



Replacement Globe
YB5169





Bulbs not included.



List price is per each (unless otherwise noted).



Product can be ordered by case quantity or individually.



All Voss™ lighting fixtures can be mounted facing either upward or downward.

MODEL LIST FINISH/CONNECT CASE QTY

ONE-HANDLE BATHROOM FAUCET				
 <p>DECKPLATE INCLUDED</p> 	<ul style="list-style-type: none"> • application: one or three hole • supply lines: flexible • connection: 3/8" compression • deckplate: included • drain assembly: metal with lift rod 	<p>1.2 GPM (4.5L/min) max.</p>		
	6803	300.60	Chrome	3
	6803BN	390.80	Brushed Nickel	3
	6803BL	405.85	Matte Black	3
	6803ORB	420.85	Oil Rubbed Bronze	3
	<p> DURALAST®</p>			



TWO-HANDLE CENTERSET BATHROOM FAUCET				
	<ul style="list-style-type: none"> • application: three hole • center dimensions: 4" center • connection: 1/2" IPS • drain assembly: metal with lift rod 	<p>1.2 GPM (4.5L/min) max.</p>		
	6802◆	216.40	Chrome	3
	6802BN	292.15	Brushed Nickel	3
	6802BL	303.00	Matte Black	3
	6802ORB	313.80	Oil Rubbed Bronze	3
	<p> DURALAST®</p>			



TWO-HANDLE WIDESPREAD BATHROOM FAUCET TRIM				
	<ul style="list-style-type: none"> • application: three hole • center dimensions: 8" - 16" center • drain assembly: metal with lift rod • valve: sold separately 	<p>1.2 GPM (4.5L/min) max.</p>		
	T6805	213.85	Chrome	3
	T6805BN	299.40	Brushed Nickel	3
	T6805BL	320.80	Matte Black	3
	T6805ORB	331.50	Oil Rubbed Bronze	3
	<p> </p>			

WIDESPREAD FAUCET VALVE					
	<ul style="list-style-type: none"> • application: three hole • center dimensions: 8" - 16" center • drain assembly: metal with lift rod 	9000◆	162.15	1/2" IPS	6
	<p> DURALOCK® DURALAST®</p>				

HOW TO ORDER
VALVES: PAGE 463

 TRIM PART #
 +
  VALVE PART #
 =
  COMPLETE FAUCET

ONE-HANDLE WALLMOUNT TUB FILLER TRIM					
	<ul style="list-style-type: none"> • application: two hole • connection: 1/2" slip fit • tub spout type: non diverter • spout reach: 10.00" • includes: high flow volume control cartridge • WMV130 series valve kit: sold separately 	WT681	435.00	Chrome	3
		WT681BN	574.20	Brushed Nickel	3
		WT681BL	631.60	Matte Black	3
		WT681ORB	631.60	Oil Rubbed Bronze	3
	<p> </p>				











ONE-HANDLE WALLMOUNT TUB FILLER VALVE KIT					
	<ul style="list-style-type: none"> • application: two hole with adj. center dimensions • ports: three • quarter turn stops: included • includes: test plug • includes: spout manifold 	WMV130CIS	151.05	1/2" CC/IPS	6
		WMV130XS	151.05	1/2" Crimp Ring PEX	6
		WMV130CXS	151.05	1/2" Cold Exp. PEX	6
	<p></p>				

HOW TO ORDER
VALVES: PAGE 463

 TRIM PART #
 +
  VALVE PART #
 =
  COMPLETE FAUCET

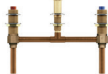









DARTMOOR®

DARTMOOR® Collection























	MODEL	LIST	FINISH/CONNECT	CASE QTY		
TWO-HANDLE ROMAN TUB TRIM						
 <ul style="list-style-type: none"> • application: three hole • spout reach: 7.64" • valve: sold separately  	T683	348.95	Chrome	3		
	T683BN	522.10	Brushed Nickel	3		
	T683BL	574.40	Matte Black	3		
	T683ORB	574.40	Oil Rubbed Bronze	3		
TWO-HANDLE ROMAN TUB VALVE						
 <ul style="list-style-type: none"> • deck thickness: 1/8" to 3-3/8" rough-in deck • adjustable spout shank: adjustable center dimensions  DURALAST®	4792	188.55	1/2" CC	6		
 <ul style="list-style-type: none"> • deck thickness: 1/8" to 2-3/4" rough-in deck • adjustable spout shank: 10" - 24" center dimensions  DURALOCK® DURALAST®	4793	213.55	1/2" CPVC, Crimp Ring PEX	6		
	4794	203.60	1/2" Crimp Ring PEX, Cold Exp. PEX	6		
 <ul style="list-style-type: none"> • deck thickness: 1/8" to 3-3/16" rough-in deck • Non-adjustable spout shank: 10" center dimensions  DURALAST®	4796	177.65	1/2" CC	6		
	4797	181.10	1/2" CPVC, Crimp Ring PEX	6		
	4798	181.10	1/2" Crimp Ring PEX, Cold Exp. PEX	6		
For more product details, reference page 464 in valve section.						
HOW TO ORDER VALVES: PAGE 464		 TRIM PART #	+	 VALVE PART #	=	 COMPLETE FAUCET





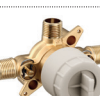















DARTMOOR®

		MODEL	LIST	FINISH/CONNECT	CASE QTY	
M-CORE® TRANSFER VALVE TRIM						
 <ul style="list-style-type: none"> • use with the M-CORE® transfer valve • valve: sold separately  		UT2031	188.60	Chrome	12	
		UT2031BN	229.05	Brushed Nickel	12	
		UT2031BL	244.80	Matte Black	12	
		UT2031ORB	244.80	Oil Rubbed Bronze	12	
M-CORE® TRANSFER VALVE						
Three Function (2 independent/1 shared) OR Six Function (3 independent/3 shared) - plumbing configuration page 472						
 <ul style="list-style-type: none"> • number of functions: three or six • ports: four 		U361CI	149.70	½" CC/IPS	6	
		U361CX	149.70	½" Cold Exp. PEX	6	
		U361X	149.70	½" Crimp Ring PEX	6	
Two Independent Functions OR Three Independent Functions - plumbing configurations page 472						
 <ul style="list-style-type: none"> • number of functions: two or three • ports: four 		U231CI	149.70	½" CC/IPS	6	
		U231CX	149.70	½" Cold Exp. PEX	6	
		U231X	149.70	½" Crimp Ring PEX	6	
For more product details, reference page 466 in valve section. See page 472 for plumbing configurations.						
HOW TO ORDER VALVES: PAGE 466		 TRIM PART #	+	 VALVE PART #	=	 COMPLETE FAUCET





















DARTMOOR® Collection

		MODEL	LIST	FINISH/CONNECT	CASE QTY
M-CORE® 2-SERIES TUB/SHOWER TRIM					
 <ul style="list-style-type: none"> • showerhead: single-function eco-performance rainshower • showerhead size: 8" diameter • tub spout length: 7" • tub spout connection type: slip fit • tub spout type: diverter • includes: pressure balanced cartridge with temperature control • valve: sold separately 	<ul style="list-style-type: none"> • 1.75 GPM (6.65 L/min) max. 	UT2283EP	307.05	Chrome	4
		UT2283EPBN	433.30	Brushed Nickel	4
		UT2283EPBL	459.25	Matte Black	4
		UT2283EPORB	459.25	Oil Rubbed Bronze	4
 <ul style="list-style-type: none"> • showerhead: single-function eco-performance • showerhead size: 4" diameter • tub spout length: 7" • tub spout connection type: slip fit • tub spout type: diverter • includes: pressure balanced cartridge with temperature control • valve: sold separately 	<ul style="list-style-type: none"> • 1.75 GPM (6.65 L/min) max. 	UT2183EP	225.75	Chrome	12
		UT2183EPBN	385.00	Brushed Nickel	12
		UT2183EPBL	411.55	Matte Black	12
		UT2183EPORB	411.55	Oil Rubbed Bronze	12
M-CORE® 2-SERIES SHOWER ONLY TRIM					
 <ul style="list-style-type: none"> • showerhead: single-function eco-performance rainshower • showerhead size: 8" diameter • includes: pressure balanced cartridge with temperature control • valve: sold separately 	<ul style="list-style-type: none"> • 1.75 GPM (6.65 L/min) max. 	UT2282EP	265.45	Chrome	4
		UT2282EPBN	370.60	Brushed Nickel	4
		UT2282EPBL	390.10	Matte Black	4
		UT2282EPORB	390.10	Oil Rubbed Bronze	4
 <ul style="list-style-type: none"> • showerhead: single-function eco-performance • showerhead size: 4" diameter • includes: pressure balanced cartridge with temperature control • valve: sold separately 	<ul style="list-style-type: none"> • 1.75 GPM (6.65 L/min) max. 	UT2182EP	186.55	Chrome	12
		UT2182EPBN	321.00	Brushed Nickel	12
		UT2182EPBL	341.00	Matte Black	12
		UT2182EPORB	341.00	Oil Rubbed Bronze	12
M-CORE® MIXING SHOWER VALVE					
 <ul style="list-style-type: none"> • tub/shower or shower only application • ports: four with adj. temp. limit stops • included: test plug and cross flow plug 		U140CI	71.20	1/2" CC/IPS	6
		U140X	71.20	1/2" Crimp Ring PEX + CC/IPS Tub	6
		U140CX	71.20	1/2" Cold Exp. PEX + CC/IPS Tub	6
		U140V	87.20	1/2" CPVC + CC/IPS Tub	6
 <ul style="list-style-type: none"> • tub/shower or shower only application • ports: four with adj. temp. limit stops • quarter turn stops: included 		U140CIS	102.45	1/2" CC/IPS	6
		U140XS	102.45	1/2" Crimp Ring PEX + CC/IPS Tub	6
		U140CXS	102.45	1/2" Cold Exp. PEX + CC/IPS Tub	6
		U140VS	118.50	1/2" CPVC + CC/IPS Tub	6
 <ul style="list-style-type: none"> • tub/shower only application • ports: four with adj. temp. limit stops • tub outlet: pre-fabricated 1/2" copper tube • included: quarter turn stops and plugs 		U140X-PF	80.40	1/2" Crimp Ring PEX	6
		U140CX-PF	80.40	1/2" Cold Exp. PEX	6
 <ul style="list-style-type: none"> • tub/shower only application • ports: four with adj. temp. limit stops • tub outlet: pre-fabricated 1/2" copper tube • included: quarter turn stops and plugs 		U140XS-PF	111.70	1/2" Crimp Ring PEX	6
		U140CXS-PF	111.70	1/2" Cold Exp. PEX	6
 <ul style="list-style-type: none"> • shower only application • ports: three 		U130CI	71.20	1/2" CC/IPS	6
		U130X	71.20	1/2" Crimp Ring PEX	6
		U130CX	71.20	1/2" Cold Exp. PEX	6
 <ul style="list-style-type: none"> • shower only application • ports: three • quarter turn stops: included 		U130CIS	102.45	1/2" CC/IPS	6
		U130XS	102.45	1/2" Crimp Ring PEX	6
		U130CXS	102.45	1/2" Cold Exp. PEX	6
<p>Four port valves can be used with either Tub/Shower or Shower Only applications. Three port valves can ONLY be used with Shower Only applications. For more product details, reference pages 465-466 in valve section.</p>					
<p>HOW TO ORDER VALVES: PAGES 465-466</p>	 <p>TRIM PART #</p>	+	 <p>VALVE PART #</p>	=	 <p>COMPLETE FAUCET</p>

DARTMOOR®

		MODEL	LIST	FINISH/CONNECT	CASE QTY		
M-CORE® 2-SERIES VALVE ONLY TRIM							
 <ul style="list-style-type: none"> • includes: pressure balanced cartridge with temperature control • valve: sold separately 	<ul style="list-style-type: none"> • tub/shower or shower only application • ports: four with adj. temp. limit stops • included: test plug and cross flow plug 	UT2181 UT2181BN UT2181BL UT2181ORB	177.75 282.70 298.85 298.85	Chrome Brushed Nickel Matte Black Oil Rubbed Bronze	3 3 3 3		
	M-CORE® MIXING SHOWER VALVE						
	 <ul style="list-style-type: none"> • tub/shower or shower only application • ports: four with adj. temp. limit stops • included: test plug and cross flow plug 	<ul style="list-style-type: none"> • tub/shower or shower only application • ports: four with adj. temp. limit stops • quarter turn stops: included 	U140CI U140X U140CX U140V	71.20 71.20 71.20 87.20	1/2" CC/IPS 1/2" Crimp Ring PEX + CC/IPS Tub 1/2" Cold Exp. PEX + CC/IPS Tub 1/2" CPVC + CC/IPS Tub	6 6 6 6	
			 <ul style="list-style-type: none"> • tub/shower only application • ports: four with adj. temp. limit stops • tub outlet: pre-fabricated 1/2" copper tube • included: quarter turn stops and plugs 	U140CIS U140XS U140CXS U140VS	102.45 102.45 102.45 118.50	1/2" CC/IPS 1/2" Crimp Ring PEX + CC/IPS Tub 1/2" Cold Exp. PEX + CC/IPS Tub 1/2" CPVC + CC/IPS Tub	6 6 6 6
 <ul style="list-style-type: none"> • tub/shower only application • ports: four with adj. temp. limit stops • tub outlet: pre-fabricated 1/2" copper tube • included: quarter turn stops and plugs 				U140X-PF U140CX-PF	80.40 80.40	1/2" Crimp Ring PEX 1/2" Cold Exp. PEX	6 6
				 <ul style="list-style-type: none"> • shower only application • ports: three 	U130CI U130X U130CX	71.20 71.20 71.20	1/2" CC/IPS 1/2" Crimp Ring PEX 1/2" Cold Exp. PEX
 <ul style="list-style-type: none"> • shower only application • ports: three • quarter turn stops: included 	U130CIS U130XS U130CXS	102.45 102.45 102.45	1/2" CC/IPS 1/2" Crimp Ring PEX 1/2" Cold Exp. PEX		6 6 6		
	Four port valves can be used with either Tub/Shower or Shower Only applications. Three port valves can ONLY be used with Shower Only applications. For more product details, reference pages 465-466 in valve section.						
	HOW TO ORDER VALVES: PAGES 465-466		 TRIM PART #   VALVE PART #   COMPLETE FAUCET				

DARTMOOR® Collection

		MODEL	LIST	FINISH/CONNECT	CASE QTY	
POSI-TEMP® TUB/SHOWER TRIM						
 <ul style="list-style-type: none"> • showerhead: single-function eco-performance rainshower • showerhead size: 8" diameter • tub spout length: 7" • tub spout connection type: slip fit • tub spout type: diverter • valve: sold separately 		1.75 GPM (6.65 L/min) max.				
		T2283EP	186.85	Chrome	4	
		T2283EPBN	313.10	Brushed Nickel	4	
		T2283EPBL	339.05	Matte Black	4	
		T2283EPORB	339.05	Oil Rubbed Bronze	4	
 <ul style="list-style-type: none"> • showerhead: single-function standard • showerhead size: 4" diameter • tub spout length: 7" • tub spout connection type: slip fit • tub spout type: diverter • valve: sold separately 		2.5 GPM (9.5 L/min) max.				
		T2183◆	135.80	Chrome	3	
		T2183BN	264.90	Brushed Nickel	3	
		T2183BL	291.40	Matte Black	3	
		T2183ORB	291.40	Oil Rubbed Bronze	3	
		1.75 GPM (6.65 L/min) max.				
		T2183EP	116.60	Chrome	3	
		T2183EPBN	264.90	Brushed Nickel	3	
		T2183EPBL	291.40	Matte Black	3	
		T2183EPORB	291.40	Oil Rubbed Bronze	3	
POSI-TEMP® SHOWER ONLY TRIM						
 <ul style="list-style-type: none"> • showerhead: single-function eco-performance rainshower • showerhead size: 8" diameter • valve: sold separately 		1.75 GPM (6.65 L/min) max.				
		T2282EP	145.25	Chrome	4	
		T2282EPBN	250.45	Brushed Nickel	4	
		T2282EPBL	270.00	Matte Black	4	
		T2282EPORB	270.00	Oil Rubbed Bronze	4	
 <ul style="list-style-type: none"> • showerhead: single-function standard • showerhead size: 4" diameter • valve: sold separately 		2.5 GPM (9.5 L/min) max.				
		T2182◆	93.35	Chrome	3	
		T2182BN	200.85	Brushed Nickel	3	
		T2182BL	220.85	Matte Black	3	
		T2182ORB	220.85	Oil Rubbed Bronze	3	
		1.75 GPM (6.65 L/min) max.				
		T2182EP	77.40	Chrome	3	
		T2182EPBN	200.85	Brushed Nickel	3	
		T2182EPBL	220.85	Matte Black	3	
		T2182EPORB	220.85	Oil Rubbed Bronze	3	
POSI-TEMP® VALVE ONLY TRIM						
 <ul style="list-style-type: none"> • valve: sold separately 		T2181	71.15	Chrome	3	
		T2181BN	162.55	Brushed Nickel	3	
		T2181BL	178.70	Matte Black	3	
		T2181ORB	178.70	Oil Rubbed Bronze	3	
	POSI-TEMP® SHOWER MIXING VALVES					
 <ul style="list-style-type: none"> • tub/shower or shower only application • ports: four with adjustable temp. limit stops • test plug: included 		2520◆	156.10	1/2" CC	6	
		2510◆	156.10	1/2" IPS	6	
 <ul style="list-style-type: none"> • tub/shower or shower only application • ports: four with adjustable temp. limit stops • quarter turn stops: included • test plug: included 		2570◆	189.55	1/2" CC	6	
		2590◆	189.55	1/2" IPS	6	
		2580◆	156.10	1/2" Crimp ring PEX	6	
	 <ul style="list-style-type: none"> • tub/shower only application • ports: four with adjustable temp. limit stops • quarter turn stops: included • test plug: included 		2360PF	208.45	1/2" Crimp Ring PEX	3
		2385PF	208.45	1/2" Cold Exp. PEX	3	
 <ul style="list-style-type: none"> • shower only application • ports: three with adjustable temp. limit stops • quarter turn stops: included • test plug: included 		2326PF	201.20	1/2" Crimp Ring PEX	6	
		2328PF	201.20	1/2" Cold Exp. PEX	6	
Four port valves can be used with either Tub/Shower or Shower Only applications. Three port valves can ONLY be used with Shower Only applications. For more product details, reference page 467-468 in valve section.						
HOW TO ORDER VALVES: PAGES 467-470		 TRIM PART #	+	 VALVE PART #	=	 COMPLETE FAUCET

DARTMOOR®

Moen® bath accessories CANNOT be combined with Moen faucet parts on a Purchase Order.

A PERFECT MATCH

A line of perfectly matching accessories - including tank levers and towel bars - allow for a completely cohesive look in the bath.

MODEL NUMBER	LIST EACH	DESCRIPTION	QTY
Chrome (CH)			
YB2101CH	25.00	Tank Lever	24
YB2103CH	18.65	Double Robe Hook	24
YB2108CH	33.25	Paper Holder	6
YB2118CH	40.80	18" Towel Bar	6
YB2124CH	43.05	24" Towel Bar	6
YB2186CH	25.40	Towel Ring	6
Brushed Nickel (BN)			
YB2101BN	40.10	Tank Lever	24
YB2103BN	28.40	Double Robe Hook	24
YB2108BN	51.15	Paper Holder	6
YB2118BN	62.70	18" Towel Bar	6
YB2124BN	65.95	24" Towel Bar	6
YB2186BN	38.65	Towel Ring	6
Matte Black (BL)			
YB2101BL	44.15	Tank Lever	24
YB2103BL	31.20	Double Robe Hook	24
YB2108BL	56.15	Paper Holder	6
YB2118BL	68.90	18" Towel Bar	6
YB2124BL	72.40	24" Towel Bar	6
YB2186BL	42.65	Towel Ring	6
Oil Rubbed Bronze (ORB)			
YB2101ORB	44.15	Tank Lever	24
YB2103ORB	31.20	Double Robe Hook	24
YB2108ORB	56.15	Paper Holder	6
YB2118ORB	68.90	18" Towel Bar	6
YB2124ORB	72.40	24" Towel Bar	6
YB2186ORB	42.65	Towel Ring	6
Pro-Fit® Installation Mounting Template			
YB8081	14.90	Pro-Fit® Installation Mounting Template	25



Tank Lever

YB2101



Double Robe Hook

YB2103



Towel Ring

YB2186



Paper Holder

YB2108



18" Towel Bar

YB2118



YB8081
Pro-Fit® Installation Mounting Template
(See page 480 for more information about the Pro-Fit® Installation System.)

24" Towel Bar

YB2124

PRODUCT DETAILS

5/8" Round Bar

30" towel bar options also available in select finishes.





See page 502 for details.



List price is per each (unless otherwise noted).





Product can be ordered by case quantity or individually.



For more information on ordering bath accessories, contact Moen Bath Accessory Customer Service at **800-882-0116**, contact your local Moen sales representative, or visit us at www.moen.com.

GLYDE™ Collection

	MODEL	LIST	FINISH/CONNECT	CASE QTY
ONE-HANDLE BATHROOM FAUCET				
 <p>DECKPLATE INCLUDED</p>  <ul style="list-style-type: none"> • application: one or three hole • supply lines: flexible • connection: 3/8" compression • deckplate: included • drain assembly: metal with lift rod <p> DURALAST®</p>	<p> 1.2 GPM (4.5L/min) max.</p>			
	6170	300.60	Chrome	3
	6170BN	390.80	Brushed Nickel	3
	6170BL	405.85	Matte Black	3

TWO-HANDLE CENTERSET BATHROOM FAUCET				
 <ul style="list-style-type: none"> • application: three hole • center dimensions: 4" center • connection: 1/2" IPS • drain assembly: metal with lift rod <p> DURALAST®</p>	<p> 1.2 GPM (4.5L/min) max.</p>			
	6172◆	216.40	Chrome	3
	6172BN	292.15	Brushed Nickel	3
	6172BL	303.00	Matte Black	1

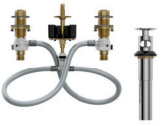
TWO-HANDLE WIDESPREAD BATHROOM FAUCET TRIM				
 <ul style="list-style-type: none"> • application: three hole • center dimensions: 8" - 16" center • drain assembly: metal with lift rod • valve: sold separately <p> </p>	<p> 1.2 GPM (4.5L/min) max.</p>			
	T6173	213.85	Chrome	3
	T6173BN	299.40	Brushed Nickel	3
	T6173BL	320.80	Matte Black	3



WIDESPREAD FAUCET VALVE				
 <ul style="list-style-type: none"> • application: three hole • center dimensions: 8" - 16" center • drain assembly: metal with lift rod <p> DURALOCK® DURALAST®</p>	9000◆	162.15	1/2" IPS	6



HOW TO ORDER
VALVES: PAGE 463

TRIM PART #

VALVE PART #

COMPLETE FAUCET

ONE-HANDLE WALLMOUNT TUB FILLER TRIM				
 <ul style="list-style-type: none"> • application: two hole • connection: 1/2" slip fit • tub spout type: non diverter • spout reach: 10.00" • includes: high flow volume control cartridge • WMV130 series valve kit: sold separately <p> </p>	WT371	435.00	Chrome	3
	WT371BN	574.20	Brushed Nickel	3
	WT371BL	631.60	Matte Black	3

ONE-HANDLE WALLMOUNT TUB FILLER VALVE KIT				
 <ul style="list-style-type: none"> • application: two hole with adj. center dimensions • ports: three • quarter turn stops: included • includes: test plug • includes: spout manifold <p></p>	WMV130CIS	151.05	1/2" CC/IPS	6
	WMV130XS	151.05	1/2" Crimp Ring PEX	6
	WMV130CXS	151.05	1/2" Cold Exp. PEX	6











HOW TO ORDER
VALVES: PAGE 463











TRIM PART #

VALVE PART #

























COMPLETE FAUCET

GLYDE™



















	MODEL	LIST	FINISH/CONNECT	CASE QTY						
TWO-HANDLE ROMAN TUB TRIM										
 <ul style="list-style-type: none"> • application: three hole • spout reach: 7.65" • valve: sold separately 	T373	348.95	Chrome	3						
	T373BN	522.10	Brushed Nickel	3						
	T373BL	574.40	Matte Black	3						
TWO-HANDLE ROMAN TUB VALVE										
 <ul style="list-style-type: none"> • deck thickness: 1/8" to 3-3/8" rough-in deck • adjustable spout shank: adjustable center dimensions  DURALAST®	4792	188.55	1/2" CC	6						
 <ul style="list-style-type: none"> • deck thickness: 1/8" to 2-3/4" rough-in deck • adjustable spout shank: 10" - 24" center dimensions  DURALOCK® DURALAST®	4793	213.55	1/2" CPVC, Crimp Ring PEX	6						
	4794	203.60	1/2" Crimp Ring PEX, Cold Exp. PEX	6						
 <ul style="list-style-type: none"> • deck thickness: 1/8" to 3-3/16" rough-in deck • Non-adjustable spout shank: 10" center dimensions  DURALAST®	4796	177.65	1/2" CC	6						
	4797	181.10	1/2" CPVC, Crimp Ring PEX	6						
	4798	181.10	1/2" Crimp Ring PEX, Cold Exp. PEX	6						
For more product details, reference page 464 in valve section.										
HOW TO ORDER VALVES: PAGE 464		 TRIM PART #			+	 VALVE PART #		=	 COMPLETE FAUCET	

M-CORE® TRANSFER VALVE TRIM										
 <ul style="list-style-type: none"> • use with the M-CORE® transfer valve • valve: sold separately 	UT2721	188.60	Chrome	12						
	UT2721BN	229.05	Brushed Nickel	12						
	UT2721BL	244.80	Matte Black	12						
M-CORE® TRANSFER VALVE										
Three Function (2 independent/1 shared) OR Six Function (3 independent/3 shared) - plumbing configuration page 472										
 <ul style="list-style-type: none"> • number of functions: three or six • ports: four 	U361CI	149.70	1/2" CC/IPS	6						
	U361CX	149.70	1/2" Cold Exp. PEX	6						
	U361X	149.70	1/2" Crimp Ring PEX	6						
Two Independent Functions OR Three Independent Functions - plumbing configurations page 472										
 <ul style="list-style-type: none"> • number of functions: two or three • ports: four 	U231CI	149.70	1/2" CC/IPS	6						
	U231CX	149.70	1/2" Cold Exp. PEX	6						
	U231X	149.70	1/2" Crimp Ring PEX	6						
For more product details, reference page 466 in valve section. See page 472 for plumbing configurations.										
HOW TO ORDER VALVES: PAGE 466		 TRIM PART #			+	 VALVE PART #		=	 COMPLETE FAUCET	



























GLYDE™ Collection

		MODEL	LIST	FINISH/CONNECT	CASE QTY	
M-CORE® 2-SERIES TUB/SHOWER TRIM						
 <ul style="list-style-type: none"> • showerhead: single-function eco-performance rainshower • showerhead size: 8" diameter • tub spout length: 7" • tub spout connection type: slip fit • tub spout type: diverter • includes: pressure balanced cartridge with temperature control • valve: sold separately 		1.75 GPM (6.65 L/min) max.				
		UT2843EP	307.05	Chrome	4	
		UT2843EPBN	433.30	Brushed Nickel	4	
		UT2843EPBL	459.25	Matte Black	4	
						
 <ul style="list-style-type: none"> • showerhead: single-function eco-performance • showerhead size: 3-3/4" diameter • tub spout length: 7" • tub spout connection type: slip fit • tub spout type: diverter • includes: pressure balanced cartridge with temperature control • valve: sold separately 		1.75 GPM (6.65 L/min) max.				
		UT2743EP	225.75	Chrome	3	
		UT2743EPBN	385.00	Brushed Nickel	3	
		UT2743EPBL	411.50	Matte Black	3	
						
M-CORE® 2-SERIES SHOWER ONLY TRIM						
 <ul style="list-style-type: none"> • showerhead: single-function eco-performance rainshower • showerhead size: 8" diameter • includes: pressure balanced cartridge with temperature control • valve: sold separately 		1.75 GPM (6.65 L/min) max.				
		UT2842EP	265.45	Chrome	4	
		UT2842EPBN	370.60	Brushed Nickel	4	
						
 <ul style="list-style-type: none"> • showerhead: single-function eco-performance • showerhead size: 3-3/4" diameter • includes: pressure balanced cartridge with temperature control • valve: sold separately 		1.75 GPM (6.65 L/min) max.				
		UT2742EP	186.55	Chrome	12	
		UT2742EPBN	321.00	Brushed Nickel	12	
						
		UT2742EPBL	341.00	Matte Black	12	
M-CORE® MIXING SHOWER VALVE						
 <ul style="list-style-type: none"> • tub/shower or shower only application • ports: four with adj. temp. limit stops • included: test plug and cross flow plug 		U140CI	71.20	1/2" CC/IPS	6	
		U140X	71.20	1/2" Crimp Ring PEX + CC/IPS Tub	6	
		U140CX	71.20	1/2" Cold Exp. PEX + CC/IPS Tub	6	
		U140V	87.20	1/2" CPVC + CC/IPS Tub	6	
						
 <ul style="list-style-type: none"> • tub/shower or shower only application • ports: four with adj. temp. limit stops • quarter turn stops: included 		U140CIS	102.45	1/2" CC/IPS	6	
		U140XS	102.45	1/2" Crimp Ring PEX + CC/IPS Tub	6	
		U140CXS	102.45	1/2" Cold Exp. PEX + CC/IPS Tub	6	
		U140VS	118.50	1/2" CPVC + CC/IPS Tub	6	
						
 <ul style="list-style-type: none"> • tub/shower only application • ports: four with adj. temp. limit stops • tub outlet: pre-fabricated 1/2" copper tube • included: quarter turn stops and plugs 		U140X-PF	80.40	1/2" Crimp Ring PEX	6	
		U140CX-PF	80.40	1/2" Cold Exp. PEX	6	
						
 <ul style="list-style-type: none"> • tub/shower only application • ports: four with adj. temp. limit stops • tub outlet: pre-fabricated 1/2" copper tube • included: quarter turn stops and plugs 		U140XS-PF	111.70	1/2" Crimp Ring PEX	6	
		U140CXS-PF	111.70	1/2" Cold Exp. PEX	6	
						
 <ul style="list-style-type: none"> • shower only application • ports: three 		U130CI	71.20	1/2" CC/IPS	6	
		U130X	71.20	1/2" Crimp Ring PEX	6	
		U130CX	71.20	1/2" Cold Exp. PEX	6	
						
 <ul style="list-style-type: none"> • shower only application • ports: three • quarter turn stops: included 		U130CIS	102.45	1/2" CC/IPS	6	
		U130XS	102.45	1/2" Crimp Ring PEX	6	
		U130CXS	102.45	1/2" Cold Exp. PEX	6	
						
<p>Four port valves can be used with either Tub/Shower or Shower Only applications. Three port valves can ONLY be used with Shower Only applications. For more product details, reference pages 465-466 in valve section.</p>						
<p>HOW TO ORDER VALVES: PAGES 465-466</p>		 <p>TRIM PART #</p>	+	 <p>VALVE PART #</p>	=	 <p>COMPLETE FAUCET</p>

GLYDE™

		MODEL	LIST	FINISH/CONNECT	CASE QTY	
M-CORE® 2-SERIES VALVE ONLY TRIM						
 <ul style="list-style-type: none"> includes: pressure balanced cartridge with temperature control valve: sold separately 		UT2741	177.75	Chrome	3	
		UT2741BN	282.70	Brushed Nickel	3	
	 	UT2741BL	298.85	Matte Black	3	
M-CORE® MIXING SHOWER VALVE						
 <ul style="list-style-type: none"> tub/shower or shower only application ports: four with adj. temp. limit stops included: test plug and cross flow plug 		U140CI	71.20	1/2" CC/IPS	6	
		U140X	71.20	1/2" Crimp Ring PEX + CC/IPS Tub	6	
		U140CX	71.20	1/2" Cold Exp. PEX + CC/IPS Tub	6	
		U140V	87.20	1/2" CPVC + CC/IPS Tub	6	
 <ul style="list-style-type: none"> tub/shower or shower only application ports: four with adj. temp. limit stops quarter turn stops: included 		U140CIS	102.45	1/2" CC/IPS	6	
		U140XS	102.45	1/2" Crimp Ring PEX + CC/IPS Tub	6	
		U140CXS	102.45	1/2" Cold Exp. PEX + CC/IPS Tub	6	
		U140VS	118.50	1/2" CPVC + CC/IPS Tub	6	
 <ul style="list-style-type: none"> tub/shower only application ports: four with adj. temp. limit stops tub outlet: pre-fabricated 1/2" copper tube included: quarter turn stops and plugs 		U140X-PF	80.40	1/2" Crimp Ring PEX	6	
		U140CX-PF	80.40	1/2" Cold Exp. PEX	6	
 <ul style="list-style-type: none"> tub/shower only application ports: four with adj. temp. limit stops tub outlet: pre-fabricated 1/2" copper tube included: quarter turn stops and plugs 		U140XS-PF	111.70	1/2" Crimp Ring PEX	6	
		U140CXS-PF	111.70	1/2" Cold Exp. PEX	6	
 <ul style="list-style-type: none"> shower only application ports: three 		U130CI	71.20	1/2" CC/IPS	6	
		U130X	71.20	1/2" Crimp Ring PEX	6	
		U130CX	71.20	1/2" Cold Exp. PEX	6	
 <ul style="list-style-type: none"> shower only application ports: three quarter turn stops: included 		U130CIS	102.45	1/2" CC/IPS	6	
		U130XS	102.45	1/2" Crimp Ring PEX	6	
		U130CXS	102.45	1/2" Cold Exp. PEX	6	
<p>Four port valves can be used with either Tub/Shower or Shower Only applications. Three port valves can ONLY be used with Shower Only applications. For more product details, reference pages 465-466 in valve section.</p>						
<p>HOW TO ORDER VALVES: PAGES 465-466</p>		 <p>TRIM PART #</p>	+	 <p>VALVE PART #</p>	=	 <p>COMPLETE FAUCET</p>

GLYDE™ Collection

		MODEL	LIST	FINISH/CONNECT	CASE QTY	
POSI-TEMP® TUB/SHOWER TRIM						
 <ul style="list-style-type: none"> • showerhead: single-function standard • showerhead size: 3-3/4" diameter • tub spout length: 7" • tub spout connection type: slip fit • tub spout type: diverter • valve: sold separately 		2.5 GPM (9.5 L/min) max.				
		T2743◆	135.80	Chrome	3	
		T2743BN	264.90	Brushed Nickel	3	
		2.5 GPM (9.5 L/min) max.				
		T2743BL	291.40	Matte Black	3	
		1.75 GPM (6.65 L/min) max.				
		T2743EP	116.60	Chrome	3	
		T2743EPBN	264.90	Brushed Nickel	3	
		T2743EPBL	291.40	Matte Black	3	
POSI-TEMP® SHOWER ONLY TRIM						
 <ul style="list-style-type: none"> • showerhead: single-function eco-performance rainshower • showerhead size: 8" diameter • valve: sold separately 		1.75 GPM (6.65 L/min) max.				
		T2842EP	145.25	Chrome	4	
		T2842EPBN	250.45	Brushed Nickel	4	
		1.75 GPM (6.65 L/min) max.				
		T2842EPBL	270.00	Matte Black	4	
		2.5 GPM (9.5 L/min) max.				
 <ul style="list-style-type: none"> • showerhead: single-function standard • showerhead size: 3-3/4" diameter • valve: sold separately 		T2742◆	93.35	Chrome	3	
		T2742BN	200.85	Brushed Nickel	3	
		T2742BL	220.85	Matte Black	3	
		1.75 GPM (6.65 L/min) max.				
		T2742EP	77.40	Chrome	3	
		T2742EPBN	200.85	Brushed Nickel	3	
POSI-TEMP® VALVE ONLY TRIM						
 <ul style="list-style-type: none"> • valve: sold separately 		T2741	71.15	Chrome	3	
		T2741BN	162.55	Brushed Nickel	3	
		T2741BL	178.70	Matte Black	3	
POSI-TEMP® SHOWER MIXING VALVES						
 <ul style="list-style-type: none"> • tub/shower or shower only application • ports: four with adjustable temp. limit stops • test plug: included 		2520◆	156.10	1/2" CC	6	
		2510◆	156.10	1/2" IPS	6	
 <ul style="list-style-type: none"> • tub/shower or shower only application • ports: four with adjustable temp. limit stops • quarter turn stops: included • test plug: included 		2570◆	189.55	1/2" CC	6	
		2590◆	189.55	1/2" IPS	6	
		2580◆	156.10	1/2" Crimp ring PEX	6	
		2.5 GPM (9.5 L/min) max.				
 <ul style="list-style-type: none"> • tub/shower only application • ports: four with adjustable temp. limit stops • quarter turn stops: included • test plug: included 		2360PF	208.45	1/2" Crimp Ring PEX	3	
		2385PF	208.45	1/2" Cold Exp. PEX	3	
 <ul style="list-style-type: none"> • shower only application • ports: three with adjustable temp. limit stops • quarter turn stops: included • test plug: included 		2326PF	201.20	1/2" Crimp Ring PEX	6	
		2328PF	201.20	1/2" Cold Exp. PEX	6	
<p>Four port valves can be used with either Tub/Shower or Shower Only applications. Three port valves can ONLY be used with Shower Only applications. For more product details, reference page 467-468 in valve section.</p>						
<p>HOW TO ORDER VALVES: PAGES 467-470</p>		 <p>TRIM PART #</p>	+	 <p>VALVE PART #</p>	=	 <p>COMPLETE FAUCET</p>

GLYDE™

Moen® bath accessories CANNOT be combined with Moen faucet parts on a Purchase Order.

A PERFECT MATCH

A line of perfectly matching accessories - including tank levers and towel bars - allow for a completely cohesive look in the bath.

MODEL NUMBER	LIST EACH	DESCRIPTION	QTY
Chrome (CH)			
YB2303CH	18.65	Double Robe Hook	24
YB2308CH	33.25	Paper Holder	6
YB2318CH	40.80	18" Towel Bar	6
YB2324CH	43.05	24" Towel Bar	6
YB2386CH	25.40	Towel Ring	6
Brushed Nickel (BN)			
YB2303BN	28.40	Double Robe Hook	24
YB2308BN	51.15	Paper Holder	6
YB2318BN	62.70	18" Towel Bar	6
YB2324BN	65.95	24" Towel Bar	6
YB2386BN	38.65	Towel Ring	6
Matte Black (BL)			
YB2303BL	31.20	Double Robe Hook	24
YB2308BL	56.15	Paper Holder	6
YB2318BL	68.90	18" Towel Bar	6
YB2324BL	72.40	24" Towel Bar	6
YB2386BL	42.65	Towel Ring	6
Pro-Fit® Installation Mounting Template			
YB8081	14.90	Pro-Fit® Installation Mounting Template	25



Double Robe Hook
YB2303



Towel Ring
YB2386



Paper Holder
YB2308



18" Towel Bar
YB2318

24" Towel Bar
YB2324



YB8081
Pro-Fit® Installation Mounting Template
(See page 480 for more information about the Pro-Fit® Installation System.)

PRODUCT DETAILS

5/8" Round Bar

30" towel bar options also available in select finishes.

















See page 502 for details.

List price is per each (unless otherwise noted).

















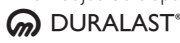

Product can be ordered by case quantity or individually.

For more information on ordering bath accessories, contact Moen Bath Accessory Customer Service at **800-882-0116**, contact your local Moen sales representative, or visit us at www.moen.com.









BRANTFORD® Collection

	MODEL	LIST	FINISH/CONNECT	CASE QTY
ONE-HANDLE BATHROOM FAUCET				
 <p>DECKPLATE INCLUDED</p>  <ul style="list-style-type: none"> • application: one or three hole • supply lines: flexible • connection: 3/8" compression • deckplate: included • drain assembly: metal with lift rod <p> DURALAST®</p>	<p> 1.2 GPM (4.5L/min) max.</p>			
	6600	300.60	Chrome	3
	6600BN	390.80	Brushed Nickel	3
	6600ORB	420.85	Oil Rubbed Bronze	3
OPTION: VESSEL EXTENSION KIT				
 <ul style="list-style-type: none"> • description: vessel extension kit • included: parts to convert to grid drain • Included: two 2.5" extensions 	A1717	175.40	Chrome	6
	A1717BN	251.30	Brushed Nickel	6
	A1717ORB	273.10	Oil Rubbed Bronze	6
TWO-HANDLE CENTERSET BATHROOM FAUCET				
 <ul style="list-style-type: none"> • application: three hole • center dimensions: 4" center • connection: 1/2" IPS • drain assembly: metal with lift rod <p> DURALAST®</p>	<p> 1.2 GPM (4.5L/min) max.</p>			
	6610◆	216.40	Chrome	6
	6610BN	292.15	Brushed Nickel	6
	6610ORB	313.80	Oil Rubbed Bronze	6
TWO-HANDLE WIDESPREAD BATHROOM FAUCET TRIM				
 <ul style="list-style-type: none"> • application: three hole • center dimensions: 8" - 16" center • drain assembly: metal with lift rod • valve: sold separately <p> </p>	<p> 1.2 GPM (4.5L/min) max.</p>			
	T6620	213.85	Chrome	3
	T6620BN	299.40	Brushed Nickel	3
	T6620ORB	331.50	Oil Rubbed Bronze	3
WIDESPREAD FAUCET VALVE				
 <ul style="list-style-type: none"> • application: three hole • center dimensions: 8" - 16" center • drain assembly: metal with lift rod <p> DURALOCK® DURALAST®</p>	9000◆	162.15	1/2" IPS	6
	<p>HOW TO ORDER VALVES: PAGE 463</p> <p>  TRIM PART # +  VALVE PART # =  COMPLETE FAUCET </p>			











BRANTFORD® Collection

	MODEL	LIST	FINISH/CONNECT	CASE QTY
TWO-HANDLE ROMAN TUB TRIM				
 <ul style="list-style-type: none"> • for garden tub application • application: three hole • spout reach: 6.50" • valve: sold separately 	T4943	263.35	Chrome	3
	T4943BN	343.80	Brushed Nickel	3
	T4943ORB	378.05	Oil Rubbed Bronze	3
 <ul style="list-style-type: none"> • application: three hole • spout reach: 8.13" • valve: sold separately 	T933	348.95	Chrome	3
	T933BN	522.10	Brushed Nickel	3
	T933ORB	574.40	Oil Rubbed Bronze	3
TWO-HANDLE ROMAN TUB TRIM WITH HANDSHOWER				
 <ul style="list-style-type: none"> • application: four hole • showerhead type: handshower • handshower flow rate: 1.75 gpm (6.65 L/min) max. • spray functions: one-function • spout reach: 8.13" • valve: sold separately 	T924	547.95	Chrome	3
	T924BN	694.15	Brushed Nickel	3
	T924ORB	763.65	Oil Rubbed Bronze	3
TWO-HANDLE ROMAN TUB VALVE				
 <ul style="list-style-type: none"> • deck thickness: 1/8" to 3-3/8" rough-in deck • adjustable spout shank: adjustable center dimensions 	4792	188.55	1/2" CC	6
	 <ul style="list-style-type: none"> • deck thickness: 1/8" to 2-3/4" rough-in deck • adjustable spout shank: 10" - 24" center dimensions 	4793	213.55	1/2" CPVC, Crimp Ring PEX
 <ul style="list-style-type: none"> • deck thickness: 1/8" to 3-3/16" rough-in deck • Non-adjustable spout shank: 10" center dimensions 		4796	177.65	1/2" CC
	4797	181.10	1/2" CPVC, Crimp Ring PEX	6
	4798	181.10	1/2" Crimp Ring PEX, Cold Exp. PEX	6
TWO-HANDLE ROMAN TUB VALVE WITH HANDSHOWER				
 <ul style="list-style-type: none"> • deck thickness: 1/8" to 2-5/8" rough-in deck • non-adj spout shank: adjustable center dim's 	9792	424.85	1/2" CC	6
	 <ul style="list-style-type: none"> • deck thickness: 1/8" to 2-5/8" rough-in deck • adj spout shank: 10" - 24" center dimensions 	9793	434.80	1/2" CPVC, Crimp Ring PEX
For more product details, reference page 464 in valve section.				
HOW TO ORDER VALVES: PAGE 464		 TRIM PART # +  VALVE PART # =  COMPLETE FAUCET		

BRANTFORD® Collection

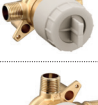





















		MODEL	LIST	FINISH/CONNECT	CASE QTY	
M-CORE® TRANSFER VALVE TRIM						
 <ul style="list-style-type: none"> • use with the M-CORE® transfer valve • valve: sold separately 		UT2021	188.60	Chrome	12	
		UT2021BN	229.05	Brushed Nickel	12	
		UT2021ORB	244.80	Oil Rubbed Bronze	12	
M-CORE® TRANSFER VALVE						
Three Function (2 independent/1 shared) OR Six Function (3 independent/3 shared) - plumbing configuration page 472						
 <ul style="list-style-type: none"> • number of functions: three or six • ports: four 		U361CI	149.70	1/2" CC/IPS	6	
		U361CX	149.70	1/2" Cold Exp. PEX	6	
		U361X	149.70	1/2" Crimp Ring PEX	6	
Two Independent Functions OR Three Independent Functions - plumbing configurations page 472						
 <ul style="list-style-type: none"> • number of functions: two or three • ports: four 		U231CI	149.70	1/2" CC/IPS	6	
		U231CX	149.70	1/2" Cold Exp. PEX	6	
		U231X	149.70	1/2" Crimp Ring PEX	6	
For more product details, reference page 466 in valve section. See page 472 for plumbing configurations.						
HOW TO ORDER VALVES: PAGE 466		 TRIM PART #	+	 VALVE PART #	=	 COMPLETE FAUCET

BRANTFORD® Collection

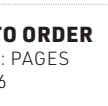
		MODEL	LIST	FINISH/CONNECT	CASE QTY			
M-CORE® 2-SERIES TUB/SHOWER TRIM								
 <ul style="list-style-type: none"> • showerhead: single-function eco-performance rainshower • showerhead size: 8" diameter • tub spout length: 6 1/2" • tub spout connection type: slip fit • tub spout type: diverter • includes: pressure balanced cartridge with temperature control • valve: sold separately 		1.75 GPM (6.65 L/min) max.						
		UT2253EP	307.05	Chrome	4			
		UT2253EPBN	433.30	Brushed Nickel	4			
		UT2253EPORB	459.25	Oil Rubbed Bronze	4			
 <ul style="list-style-type: none"> • showerhead: single-function eco-performance • showerhead size: 3-1/2" diameter • tub spout length: 6 1/2" • tub spout connection type: slip fit • tub spout type: diverter • includes: pressure balanced cartridge with temperature control • valve: sold separately 		1.75 GPM (6.65 L/min) max.						
		UT2153EP	225.75	Chrome	3			
		UT2153EPBN	385.00	Brushed Nickel	3			
		UT2153EPORB	411.55	Oil Rubbed Bronze	3			
 <ul style="list-style-type: none"> • showerhead type: showerhead sold separately • tub spout length: 6 1/2" • tub spout connection type: slip fit • tub spout type: diverter • includes: pressure balanced cartridge with temperature control • valve: sold separately 								
		UT2153NH	220.00	Chrome	3			
		UT2153NHBN	312.10	Brushed Nickel	3			
		UT2153NHORB	337.30	Oil Rubbed Bronze	3			
M-CORE® MIXING SHOWER VALVE								
 <ul style="list-style-type: none"> • tub/shower or shower only application • ports: four with adj. temp. limit stops • included: test plug and cross flow plug 		U140CI	71.20	1/2" CC/IPS	6			
		U140X	71.20	1/2" Crimp Ring PEX + CC/IPS Tub	6			
		U140CX	71.20	1/2" Cold Exp. PEX + CC/IPS Tub	6			
		U140V	87.20	1/2" CPVC + CC/IPS Tub	6			
 <ul style="list-style-type: none"> • tub/shower or shower only application • ports: four with adj. temp. limit stops • quarter turn stops: included 		U140CIS	102.45	1/2" CC/IPS	6			
		U140XS	102.45	1/2" Crimp Ring PEX + CC/IPS Tub	6			
		U140CXS	102.45	1/2" Cold Exp. PEX + CC/IPS Tub	6			
		U140VS	118.50	1/2" CPVC + CC/IPS Tub	6			
 <ul style="list-style-type: none"> • tub/shower only application • ports: four with adj. temp. limit stops • tub outlet: pre-fabricated 1/2" copper tube • included: quarter turn stops and plugs 		U140X-PF	80.40	1/2" Crimp Ring PEX	6			
		U140CX-PF	80.40	1/2" Cold Exp. PEX	6			
 <ul style="list-style-type: none"> • tub/shower only application • ports: four with adj. temp. limit stops • tub outlet: pre-fabricated 1/2" copper tube • included: quarter turn stops and plugs 		U140XS-PF	111.70	1/2" Crimp Ring PEX	6			
		U140CXS-PF	111.70	1/2" Cold Exp. PEX	6			
 <ul style="list-style-type: none"> • shower only application • ports: three 		U130CI	71.20	1/2" CC/IPS	6			
		U130X	71.20	1/2" Crimp Ring PEX	6			
		U130CX	71.20	1/2" Cold Exp. PEX	6			
 <ul style="list-style-type: none"> • shower only application • ports: three • quarter turn stops: included 		U130CIS	102.45	1/2" CC/IPS	6			
		U130XS	102.45	1/2" Crimp Ring PEX	6			
		U130CXS	102.45	1/2" Cold Exp. PEX	6			
<p>Four port valves can be used with either Tub/Shower or Shower Only applications. Three port valves can ONLY be used with Shower Only applications. For more product details, reference pages 465-466 in valve section.</p>								
<p>HOW TO ORDER VALVES: PAGES 465-466</p>		<p>TRIM PART #</p>	+		<p>VALVE PART #</p>	=		<p>COMPLETE FAUCET</p>





















BRANTFORD® Collection

		MODEL	LIST	FINISH/CONNECT	CASE QTY	
M-CORE® 2-SERIES SHOWER ONLY TRIM						
 <ul style="list-style-type: none"> • showerhead: single-function eco-performance rainshower • showerhead size: 8" diameter • includes: pressure balanced cartridge with temperature control • valve: sold separately 	<ul style="list-style-type: none"> • 1.75 GPM (6.65 L/min) max. 	UT2252EP	265.45	Chrome	4	
		UT2252EPBN	370.60	Brushed Nickel	4	
		UT2252EPORB	390.10	Oil Rubbed Bronze	4	
 <ul style="list-style-type: none"> • showerhead: single-function eco-performance • showerhead size: 3-1/2" diameter • includes: pressure balanced cartridge with temperature control • valve: sold separately 	<ul style="list-style-type: none"> • 1.75 GPM (6.65 L/min) max. 	UT2152EP	186.55	Chrome	12	
		UT2152EPBN	321.00	Brushed Nickel	12	
		UT2152EPORB	341.00	Oil Rubbed Bronze	12	
 <ul style="list-style-type: none"> • showerhead type: showerhead sold separately • includes: pressure balanced cartridge with temperature control • valve: sold separately 		UT2152NH	182.60	Chrome	3	
		UT2152NHBN	292.40	Brushed Nickel	3	
		UT2152NHORB	309.60	Oil Rubbed Bronze	3	
M-CORE® 2-SERIES VALVE ONLY TRIM						
 <ul style="list-style-type: none"> • includes: pressure balanced cartridge with temperature control • valve: sold separately 		UT2151	177.75	Chrome	3	
		UT2151BN	282.70	Brushed Nickel	3	
		UT2151ORB	298.85	Oil Rubbed Bronze	3	
M-CORE® MIXING SHOWER VALVE						
 <ul style="list-style-type: none"> • tub/shower or shower only application • ports: four with adj. temp. limit stops • included: test plug and cross flow plug 		U140CI	71.20	1/2" CC/IPS	6	
		U140X	71.20	1/2" Crimp Ring PEX + CC/IPS Tub	6	
		U140CX	71.20	1/2" Cold Exp. PEX + CC/IPS Tub	6	
		U140V	87.20	1/2" CPVC + CC/IPS Tub	6	
 <ul style="list-style-type: none"> • tub/shower or shower only application • ports: four with adj. temp. limit stops • quarter turn stops: included 		U140CIS	102.45	1/2" CC/IPS	6	
		U140XS	102.45	1/2" Crimp Ring PEX + CC/IPS Tub	6	
		U140CXS	102.45	1/2" Cold Exp. PEX + CC/IPS Tub	6	
		U140VS	118.50	1/2" CPVC + CC/IPS Tub	6	
 <ul style="list-style-type: none"> • tub/shower only application • ports: four with adj. temp. limit stops • tub outlet: pre-fabricated 1/2" copper tube • included: quarter turn stops and plugs 		U140X-PF	80.40	1/2" Crimp Ring PEX	6	
		U140CX-PF	80.40	1/2" Cold Exp. PEX	6	
 <ul style="list-style-type: none"> • tub/shower only application • ports: four with adj. temp. limit stops • tub outlet: pre-fabricated 1/2" copper tube • included: quarter turn stops and plugs 		U140XS-PF	111.70	1/2" Crimp Ring PEX	6	
		U140CXS-PF	111.70	1/2" Cold Exp. PEX	6	
 <ul style="list-style-type: none"> • shower only application • ports: three 		U130CI	71.20	1/2" CC/IPS	6	
		U130X	71.20	1/2" Crimp Ring PEX	6	
		U130CX	71.20	1/2" Cold Exp. PEX	6	
 <ul style="list-style-type: none"> • shower only application • ports: three • quarter turn stops: included 		U130CIS	102.45	1/2" CC/IPS	6	
		U130XS	102.45	1/2" Crimp Ring PEX	6	
		U130CXS	102.45	1/2" Cold Exp. PEX	6	
<p>Four port valves can be used with either Tub/Shower or Shower Only applications. Three port valves can ONLY be used with Shower Only applications. For more product details, reference pages 465-466 in valve section.</p>						
<p>HOW TO ORDER VALVES: PAGES 465-466</p>		 <p>TRIM PART #</p>	+	 <p>VALVE PART #</p>	=	 <p>COMPLETE FAUCET</p>



















BRANTFORD®

BRANTFORD® Collection

		MODEL	LIST	FINISH/CONNECT	CASE QTY	
POSI-TEMP® TUB/SHOWER TRIM						
 <ul style="list-style-type: none"> • showerhead: single-function eco-performance rainshower • showerhead size: 8" diameter • tub spout length: 6 1/2" • tub spout connection type: slip fit • tub spout type: diverter • valve: sold separately 		1.75 GPM (6.65 L/min) max.				
		T2253EP	186.85	Chrome	4	
		T2253EPBN	313.10	Brushed Nickel	4	
		T2253EPORB	339.05	Oil Rubbed Bronze	4	
						
 <ul style="list-style-type: none"> • showerhead: single-function standard • showerhead size: 3-1/2" diameter • tub spout length: 6 1/2" • tub spout connection type: slip fit • tub spout type: diverter • valve: sold separately 		2.5 GPM (9.5 L/min) max.				
		T2153◆	135.80	Chrome	3	
		T2153BN	264.90	Brushed Nickel	3	
		T2153ORB	291.40	Oil Rubbed Bronze	3	
						
 <ul style="list-style-type: none"> • showerhead: single-function eco-performance • showerhead size: 3-1/2" diameter • tub spout length: 6 1/2" • tub spout connection type: slip fit • tub spout type: diverter • used to replace: 2 or 3 hole shower valve • valve: sold separately 		1.75 GPM (6.65 L/min) max.				
		T2157EP	166.65	Chrome	3	
		T2157EPBN	306.45	Brushed Nickel	3	
		T2157EPORB	339.05	Oil Rubbed Bronze	3	
						
 <ul style="list-style-type: none"> • showerhead: single-function eco-performance • showerhead size: 3-1/2" diameter • tub spout length: 6 1/2" • tub spout connection type: slip fit • tub spout type: diverter • chrome sold in case qty only: no single pack • valve: sold separately 		1.75 GPM (6.65 L/min) max.				
		T62153EP◆◆	116.60	Chrome	12	
		T2153EPBN	264.90	Brushed Nickel	3	
		T2153EPORB	291.40	Oil Rubbed Bronze	3	
						
POSI-TEMP® SHOWER MIXING VALVES						
 <ul style="list-style-type: none"> • tub/shower or shower only application • ports: four with adjustable temp. limit stops • test plug: included 		2520 ◆	156.10	1/2" CC	6	
		2510 ◆	156.10	1/2" IPS	6	
						
 <ul style="list-style-type: none"> • tub/shower or shower only application • ports: four with adjustable temp. limit stops • quarter turn stops: included • test plug: included 		2570 ◆	189.55	1/2" CC	6	
		2590 ◆	189.55	1/2" IPS	6	
		2580 ◆	156.10	1/2" Crimp ring PEX	6	
						
 <ul style="list-style-type: none"> • tub/shower only application • ports: four with adjustable temp. limit stops • quarter turn stops: included • test plug: included 		2360PF	208.45	1/2" Crimp Ring PEX	3	
		2385PF	208.45	1/2" Cold Exp. PEX	3	
						
 <ul style="list-style-type: none"> • shower only application • ports: three with adjustable temp. limit stops • quarter turn stops: included • test plug: included 		2326PF	201.20	1/2" Crimp Ring PEX	6	
		2328PF	201.20	1/2" Cold Exp. PEX	6	
						
<p>Four port valves can be used with either Tub/Shower or Shower Only applications. Three port valves can ONLY be used with Shower Only applications. For more product details, reference page 467-468 in valve section.</p>						
<p>HOW TO ORDER VALVES: PAGES 467-470</p>		 <p>TRIM PART #</p>	+	 <p>VALVE PART #</p>	=	 <p>COMPLETE FAUCET</p>



BRANTFORD® Collection

		MODEL	LIST	FINISH/CONNECT	CASE QTY	
POSI-TEMP® SHOWER ONLY TRIM						
 <ul style="list-style-type: none"> • showerhead: single-function eco-performance rainshower • showerhead size: 8" diameter • valve: sold separately 	<ul style="list-style-type: none"> • 1.75 GPM (6.65 L/min) max. 	T2252EP	145.25	Chrome	4	
		T2252EPBN	250.45	Brushed Nickel	4	
		T2252EPORB	270.00	Oil Rubbed Bronze	4	
	<hr/>					
 <ul style="list-style-type: none"> • showerhead: single-function standard • showerhead size: 3-1/2" diameter • valve: sold separately 	<ul style="list-style-type: none"> • 2.5 GPM (9.5 L/min) max. 	T2152◆	93.35	Chrome	3	
		T2152BN	200.85	Brushed Nickel	3	
		T2152ORB	220.85	Oil Rubbed Bronze	3	
	<hr/>					
 <ul style="list-style-type: none"> • showerhead: single-function eco-performance • showerhead size: 3-1/2" diameter • chrome sold in case qty only: no single pack • valve: sold separately 	<ul style="list-style-type: none"> • 1.75 GPM (6.65 L/min) max. 	T62152EP◆◆	77.40	Chrome	12	
		T2152EPBN	200.85	Brushed Nickel	3	
		T2152EPORB	220.85	Oil Rubbed Bronze	3	
	<hr/>					
POSI-TEMP® VALVE ONLY TRIM						
 <ul style="list-style-type: none"> • valve: sold separately 		T2151◆	71.15	Chrome	3	
		T2151BN	162.55	Brushed Nickel	3	
		T2151ORB	178.70	Oil Rubbed Bronze	3	
	<hr/>					
POSI-TEMP® SHOWER MIXING VALVES						
 <ul style="list-style-type: none"> • tub/shower or shower only application • ports: four with adjustable temp. limit stops • test plug: included 		2520◆	156.10	1/2" CC	6	
		2510◆	156.10	1/2" IPS	6	
 <ul style="list-style-type: none"> • tub/shower or shower only application • ports: four with adjustable temp. limit stops • quarter turn stops: included • test plug: included 		2570◆	189.55	1/2" CC	6	
		2590◆	189.55	1/2" IPS	6	
		2580◆	156.10	1/2" Crimp ring PEX	6	
	<hr/>					
 <ul style="list-style-type: none"> • tub/shower only application • ports: four with adjustable temp. limit stops • quarter turn stops: included • test plug: included 		2360PF	208.45	1/2" Crimp Ring PEX	3	
		2385PF	208.45	1/2" Cold Exp. PEX	3	
 <ul style="list-style-type: none"> • shower only application • ports: three with adjustable temp. limit stops • quarter turn stops: included • test plug: included 		2326PF	201.20	1/2" Crimp Ring PEX	6	
		2328PF	201.20	1/2" Cold Exp. PEX	6	
<p>Four port valves can be used with either Tub/Shower or Shower Only applications. Three port valves can ONLY be used with Shower Only applications. For more product details, reference page 467-468 in valve section.</p>						
<p>HOW TO ORDER VALVES: PAGES 467-470</p>		 <p>TRIM PART #</p>	+	 <p>VALVE PART #</p>	=	 <p>COMPLETE FAUCET</p>

BRANTFORD® Perfectly Matched Bath Accessories

Moen® bath accessories CANNOT be combined with Moen faucet parts on a Purchase Order.

A PERFECT MATCH

A line of perfectly matching accessories - including tank levers and towel bars - allow for a completely cohesive look in the bath.

MODEL NUMBER	LIST EACH	DESCRIPTION	QTY
Chrome (CH)			
YB2201CH	25.00	Tank Lever	6
YB2203CH	18.65	Double Robe Hook	24
YB2208CH	33.25	Paper Holder	6
YB2218CH	40.80	18" Towel Bar	6
YB2224CH	43.05	24" Towel Bar	6
YB2286CH	25.40	Towel Ring	6
Brushed Nickel (BN)			
YB2201BN	40.10	Tank Lever	6
YB2203BN	28.40	Double Robe Hook	24
YB2208BN	51.15	Paper Holder	6
YB2218BN	62.70	18" Towel Bar	6
YB2224BN	65.95	24" Towel Bar	6
YB2286BN	38.65	Towel Ring	6
Oil Rubbed Bronze (ORB)			
YB2201ORB	44.15	Tank Lever	6
YB2203ORB	31.20	Double Robe Hook	24
YB2208ORB	56.15	Paper Holder	6
YB2218ORB	68.90	18" Towel Bar	6
YB2224ORB	72.40	24" Towel Bar	6
YB2286ORB	42.65	Towel Ring	6
Pro-Fit® Installation Mounting Template			
YB8081	14.90	Pro-Fit® Installation Mounting Template	25



Tank Lever
YB2201



Double Robe Hook
YB2203



Towel Ring
YB2286



Paper Holder
YB2208



18" Towel Bar
YB2218



YB8081
Pro-Fit® Installation Mounting Template
(See page 480 for more information about the Pro-Fit® Installation System.)

24" Towel Bar
YB2224

GRAB BARS

MODEL NUMBER	LIST EACH	DESCRIPTION	QTY
1 1/2" • Chrome (CH)			
YG2212CH	109.65	12" Designer Grab Bar	6
YG2218CH	115.90	18" Designer Grab Bar	6
YG2224CH	121.40	24" Designer Grab Bar	6
1 1/2" • Brushed Nickel (BN)			
YG2212BN	133.75	12" Designer Grab Bar	6
YG2218BN	140.50	18" Designer Grab Bar	6
YG2224BN	152.05	24" Designer Grab Bar	6
1 1/2" • Oil Rubbed Bronze (ORB)			
YG2212ORB	146.25	12" Designer Grab Bar	6
YG2218ORB	153.70	18" Designer Grab Bar	6
YG2224ORB	169.65	24" Designer Grab Bar	6

SECUREMOUNT™

- SecureMount™ Grab Bars are manufactured with an innovative flange design that makes it easy to connect to the stud at multiple points.
- Tested to withstand 500lbs.
- To install grab bars securely without studs, use SecureMount™ Anchors. Sold separately.



24" Designer Grab Bar
YG2224

PRODUCT DETAILS

5/8" Round Bar
30" towel bar options also available in select finishes.
See page 502 for details.

Complies with Americans with Disabilities Act (ADA) specifications. SecureMount™ Grab Bars are tested to withstand 500 lb. pull when securely installed per instructions.

List price is per each (unless otherwise noted). Product can be ordered by case quantity or individually. For more information on ordering bath accessories, contact Moen Bath Accessory Customer Service at 800-882-0116, contact your local Moen sales representative, or visit us at www.moen.com.





LIGHTING

MODEL NUMBER	LIST EACH	DESCRIPTION	QTY
Chrome (CH)			
YB2261CH	147.20	One Globe Bath Light	2
YB2262CH	206.10	Two Globe Bath Light	2
YB2263CH	255.90	Three Globe Bath Light	2
YB2264CH	327.80	Four Globe Bath Light	2
Brushed Nickel (BN)			
YB2261BN	184.10	One Globe Bath Light	2
YB2262BN	257.70	Two Globe Bath Light	2
YB2263BN	319.95	Three Globe Bath Light	2
YB2264BN	409.65	Four Globe Bath Light	2
Oil Rubbed Bronze (ORB)			
YB2261ORB	184.10	One Globe Bath Light	2
YB2262ORB	257.70	Two Globe Bath Light	2
YB2263ORB	319.95	Three Globe Bath Light	2
YB2264ORB	409.65	Four Globe Bath Light	2
Replacement Globe			
YB2269	27.60	Replacement Globe	3

BRANTFORD®



One Globe Bath Light
YB2261



Two Globe Bath Light
YB2262



Three Globe Bath Light
YB2263







Four Globe Bath Light
YB2264







Replacement Globe
YB2269





Bulbs not included.
List price is per each (unless otherwise noted).
Product can be ordered by case quantity or individually.
All Brantford® lighting Fixtures can be mounted facing either upward or downward.

ONE-HANDLE BATHROOM FAUCET		MODEL	LIST	FINISH/CONNECT	CASE QTY
 <p>DECKPLATE INCLUDED</p> 	<ul style="list-style-type: none"> • application: one or three hole • supply lines: flexible • connection: 3/8" compression • deckplate: included • drain assembly: metal with lift rod <p> DURALAST®</p>	1.2 GPM (4.5L/min) max.			
		6400	300.60	Chrome	3
		6400BN	390.80	Brushed Nickel	3
		6400ORB	420.85	Oil Rubbed Bronze	3
OPTION: VESSEL EXTENSION KIT					
	<ul style="list-style-type: none"> • description: vessel extension kit • included: parts to convert to grid drain • Included: two 2.5" extensions 	A1717	175.40	Chrome	6
		A1717BN	251.30	Brushed Nickel	6
		A1717ORB	273.10	Oil Rubbed Bronze	6

TWO-HANDLE CENTERSET BATHROOM FAUCET		MODEL	LIST	FINISH/CONNECT	CASE QTY
	<ul style="list-style-type: none"> • application: three hole • center dimensions: 4" center • connection: 1/2" IPS • drain assembly: metal with lift rod <p> DURALAST®</p>	6410◆	216.40	Chrome	6
		6410BN	292.15	Brushed Nickel	6
		6410ORB	313.80	Oil Rubbed Bronze	6

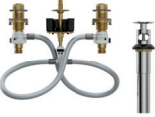













TWO-HANDLE WIDESPREAD BATHROOM FAUCET TRIM		MODEL	LIST	FINISH/CONNECT	CASE QTY
	<ul style="list-style-type: none"> • application: three hole • center dimensions: 8" - 16" center • drain assembly: metal with lift rod • valve: sold separately <p> </p>	1.2 GPM (4.5L/min) max.			
		T6420	213.85	Chrome	3
		T6420BN	299.40	Brushed Nickel	3
		T6420ORB	331.50	Oil Rubbed Bronze	3











WIDESPREAD FAUCET VALVE		MODEL	LIST	FINISH/CONNECT	CASE QTY
	<ul style="list-style-type: none"> • application: three hole • center dimensions: 8" - 16" center • drain assembly: metal with lift rod <p> DURALOCK® DURALAST®</p>	9000◆	162.15	1/2" IPS	6





















HOW TO ORDER
VALVES: PAGE 463























 TRIM PART # +  VALVE PART # =  COMPLETE FAUCET





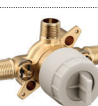

















	MODEL	LIST	FINISH/CONNECT	CASE QTY
TWO-HANDLE ROMAN TUB TRIM				
 <ul style="list-style-type: none"> • application: three hole • spout reach: 7.67" • valve: sold separately 	T943	348.95	Chrome	3
	T943BN	522.10	Brushed Nickel	3
	T943ORB	574.40	Oil Rubbed Bronze	3
TWO-HANDLE ROMAN TUB TRIM WITH HANDSHOWER				
 <ul style="list-style-type: none"> • application: four hole • showerhead type: handshower • handshower flow rate: 1.75 gpm (6.65 L/min) max. • spray functions: one-function • spout reach: 7.67" • valve: sold separately 	T944	547.95	Chrome	3
	T944BN	694.15	Brushed Nickel	3
	T944ORB	763.65	Oil Rubbed Bronze	3
TWO-HANDLE ROMAN TUB VALVE				
 <ul style="list-style-type: none"> • deck thickness: 1/8" to 3-3/8" rough-in deck • adjustable spout shank: adjustable center dimensions  DURALAST®	4792	188.55	1/2" CC	6
 <ul style="list-style-type: none"> • deck thickness: 1/8" to 2-3/4" rough-in deck • adjustable spout shank: 10" - 24" center dimensions  DURALOCK® DURALAST®	4793	213.55	1/2" CPVC, Crimp Ring PEX	6
	4794	203.60	1/2" Crimp Ring PEX, Cold Exp. PEX	6
 <ul style="list-style-type: none"> • deck thickness: 1/8" to 3-3/16" rough-in deck • Non-adjustable spout shank: 10" center dimensions  DURALAST®	4796	177.65	1/2" CC	6
	4797	181.10	1/2" CPVC, Crimp Ring PEX	6
	4798	181.10	1/2" Crimp Ring PEX, Cold Exp. PEX	6
TWO-HANDLE ROMAN TUB VALVE WITH HANDSHOWER				
 <ul style="list-style-type: none"> • deck thickness: 1/8" to 2-5/8" rough-in deck • non-adj spout shank: adjustable center dim's  DURALAST®	9792	424.85	1/2" CC	6
 <ul style="list-style-type: none"> • deck thickness: 1/8" to 2-5/8" rough-in deck • adj spout shank: 10" - 24" center dimensions  DURALOCK® DURALAST®	9793	434.80	1/2" CPVC, Crimp Ring PEX	6
For more product details, reference page 464 in valve section.				
HOW TO ORDER VALVES: PAGE 464				





















		MODEL	LIST	FINISH/CONNECT	CASE QTY			
M-CORE® TRANSFER VALVE TRIM								
 <ul style="list-style-type: none"> • use with the M-CORE® transfer valve • valve: sold separately  		UT2011	188.60	Chrome	12			
		UT2011BN	229.05	Brushed Nickel	12			
		UT2011ORB	244.80	Oil Rubbed Bronze	12			
M-CORE® TRANSFER VALVE								
Three Function (2 independent/1 shared) OR Six Function (3 independent/3 shared) - plumbing configuration page 472								
 <ul style="list-style-type: none"> • number of functions: three or six • ports: four 		U361CI	149.70	1/2" CC/IPS	6			
		U361CX	149.70	1/2" Cold Exp. PEX	6			
		U361X	149.70	1/2" Crimp Ring PEX	6			
Two Independent Functions OR Three Independent Functions - plumbing configurations page 472								
 <ul style="list-style-type: none"> • number of functions: two or three • ports: four 		U231CI	149.70	1/2" CC/IPS	6			
		U231CX	149.70	1/2" Cold Exp. PEX	6			
		U231X	149.70	1/2" Crimp Ring PEX	6			
For more product details, reference page 466 in valve section. See page 472 for plumbing configurations.								
HOW TO ORDER VALVES: PAGE 466		TRIM PART #	+		VALVE PART #	=		COMPLETE FAUCET

		MODEL	LIST	FINISH/CONNECT	CASE QTY	
M-CORE® 2-SERIES TUB/SHOWER TRIM						
	<ul style="list-style-type: none"> • showerhead: single-function eco-performance rainshower • showerhead size: 8" diameter • tub spout length: 7" • tub spout connection type: slip fit • tub spout type: diverter • includes: pressure balanced cartridge with temperature control • valve: sold separately 	1.75 GPM (6.65 L/min) max. UT2233EP	307.05	Chrome	4	
		UT2233EPBN	433.30	Brushed Nickel	4	
		UT2233EPORB	459.25	Oil Rubbed Bronze	4	
	<ul style="list-style-type: none"> • showerhead: single-function eco-performance • showerhead size: 3-1/2" diameter • tub spout length: 7" • tub spout connection type: slip fit • tub spout type: diverter • includes: pressure balanced cartridge with temperature control • valve: sold separately 	1.75 GPM (6.65 L/min) max. UT2133EP	225.75	Chrome	4	
		UT2133EPBN	385.00	Brushed Nickel	4	
		UT2133EPORB	411.55	Oil Rubbed Bronze	4	
	<ul style="list-style-type: none"> • showerhead type: showerhead sold separately • tub spout length: 7" • tub spout connection type: slip fit • tub spout type: diverter • includes: pressure balanced cartridge with temperature control • valve: sold separately 	UT2133NH	208.95	Chrome	3	
		UT2133NHBN	323.00	Brushed Nickel	3	
		UT2133NHORB	337.30	Oil Rubbed Bronze	3	
M-CORE® MIXING SHOWER VALVE						
	<ul style="list-style-type: none"> • tub/shower or shower only application • ports: four with adj. temp. limit stops • included: test plug and cross flow plug 	U140CI	71.20	1/2" CC/IPS	6	
		U140X	71.20	1/2" Crimp Ring PEX + CC/IPS Tub	6	
		U140CX	71.20	1/2" Cold Exp. PEX + CC/IPS Tub	6	
		U140V	87.20	1/2" CPVC + CC/IPS Tub	6	
	<ul style="list-style-type: none"> • tub/shower or shower only application • ports: four with adj. temp. limit stops • quarter turn stops: included 	U140CIS	102.45	1/2" CC/IPS	6	
		U140XS	102.45	1/2" Crimp Ring PEX + CC/IPS Tub	6	
		U140CXS	102.45	1/2" Cold Exp. PEX + CC/IPS Tub	6	
		U140VS	118.50	1/2" CPVC + CC/IPS Tub	6	
	<ul style="list-style-type: none"> • tub/shower only application • ports: four with adj. temp. limit stops • tub outlet: pre-fabricated 1/2" copper tube • included: quarter turn stops and plugs 	U140X-PF	80.40	1/2" Crimp Ring PEX	6	
		U140CX-PF	80.40	1/2" Cold Exp. PEX	6	
	<ul style="list-style-type: none"> • tub/shower only application • ports: four with adj. temp. limit stops • tub outlet: pre-fabricated 1/2" copper tube • included: quarter turn stops and plugs 	U140XS-PF	111.70	1/2" Crimp Ring PEX	6	
		U140CXS-PF	111.70	1/2" Cold Exp. PEX	6	
	<ul style="list-style-type: none"> • shower only application • ports: three 	U130CI	71.20	1/2" CC/IPS	6	
		U130X	71.20	1/2" Crimp Ring PEX	6	
		U130CX	71.20	1/2" Cold Exp. PEX	6	
	<ul style="list-style-type: none"> • shower only application • ports: three • quarter turn stops: included 	U130CIS	102.45	1/2" CC/IPS	6	
		U130XS	102.45	1/2" Crimp Ring PEX	6	
		U130CXS	102.45	1/2" Cold Exp. PEX	6	
<p>Four port valves can be used with either Tub/Shower or Shower Only applications. Three port valves can ONLY be used with Shower Only applications. For more product details, reference pages 465-466 in valve section.</p>						
HOW TO ORDER VALVES: PAGES 465-466		 TRIM PART #	+	 VALVE PART #	=	 COMPLETE FAUCET







		MODEL	LIST	FINISH/CONNECT	CASE QTY	
M-CORE® 2-SERIES SHOWER ONLY TRIM						
 <ul style="list-style-type: none"> • showerhead: single-function eco-performance rainshower • showerhead size: 8" diameter • includes: pressure balanced cartridge with temperature control • valve: sold separately 	<ul style="list-style-type: none"> • showerhead: single-function eco-performance rainshower • showerhead size: 8" diameter • includes: pressure balanced cartridge with temperature control • valve: sold separately 	1.75 GPM (6.65 L/min) max.				
		UT2232EP	265.45	Chrome	4	
		UT2232EPBN	370.60	Brushed Nickel	4	
		UT2232EPORB	390.10	Oil Rubbed Bronze	4	
 <ul style="list-style-type: none"> • showerhead: single-function eco-performance rainshower • showerhead size: 3-1/2" diameter • includes: pressure balanced cartridge with temperature control • valve: sold separately 	<ul style="list-style-type: none"> • showerhead: single-function eco-performance rainshower • showerhead size: 3-1/2" diameter • includes: pressure balanced cartridge with temperature control • valve: sold separately 	1.75 GPM (6.65 L/min) max.				
		UT2132EP	186.55	Chrome	12	
		UT2132EPBN	321.00	Brushed Nickel	12	
		UT2132EPORB	341.00	Oil Rubbed Bronze	12	
 <ul style="list-style-type: none"> • showerhead type: showerhead sold separately • includes: pressure balanced cartridge with temperature control • valve: sold separately 	<ul style="list-style-type: none"> • showerhead type: showerhead sold separately • includes: pressure balanced cartridge with temperature control • valve: sold separately 	UT2132NH	182.60	Chrome	3	
		UT2132NHBN	292.40	Brushed Nickel	3	
		UT2132NHORB	309.60	Oil Rubbed Bronze	3	
		M-CORE® 2-SERIES VALVE ONLY TRIM				
 <ul style="list-style-type: none"> • includes: pressure balanced cartridge with temperature control • valve: sold separately 	<ul style="list-style-type: none"> • includes: pressure balanced cartridge with temperature control • valve: sold separately 	UT2131	177.75	Chrome	3	
		UT2131BN	282.70	Brushed Nickel	3	
		UT2131ORB	298.85	Oil Rubbed Bronze	3	
		M-CORE® MIXING SHOWER VALVE				
 <ul style="list-style-type: none"> • tub/shower or shower only application • ports: four with adj. temp. limit stops • included: test plug and cross flow plug 	<ul style="list-style-type: none"> • tub/shower or shower only application • ports: four with adj. temp. limit stops • included: test plug and cross flow plug 	U140CI	71.20	1/2" CC/IPS	6	
		U140X	71.20	1/2" Crimp Ring PEX + CC/IPS Tub	6	
		U140CX	71.20	1/2" Cold Exp. PEX + CC/IPS Tub	6	
		U140V	87.20	1/2" CPVC + CC/IPS Tub	6	
 <ul style="list-style-type: none"> • tub/shower or shower only application • ports: four with adj. temp. limit stops • quarter turn stops: included 	<ul style="list-style-type: none"> • tub/shower or shower only application • ports: four with adj. temp. limit stops • quarter turn stops: included 	U140CIS	102.45	1/2" CC/IPS	6	
		U140XS	102.45	1/2" Crimp Ring PEX + CC/IPS Tub	6	
		U140CXS	102.45	1/2" Cold Exp. PEX + CC/IPS Tub	6	
		U140VS	118.50	1/2" CPVC + CC/IPS Tub	6	
 <ul style="list-style-type: none"> • tub/shower only application • ports: four with adj. temp. limit stops • tub outlet: pre-fabricated 1/2" copper tube • included: quarter turn stops and plugs 	<ul style="list-style-type: none"> • tub/shower only application • ports: four with adj. temp. limit stops • tub outlet: pre-fabricated 1/2" copper tube • included: quarter turn stops and plugs 	U140X-PF	80.40	1/2" Crimp Ring PEX	6	
		U140CX-PF	80.40	1/2" Cold Exp. PEX	6	
 <ul style="list-style-type: none"> • tub/shower only application • ports: four with adj. temp. limit stops • tub outlet: pre-fabricated 1/2" copper tube • included: quarter turn stops and plugs 	<ul style="list-style-type: none"> • tub/shower only application • ports: four with adj. temp. limit stops • tub outlet: pre-fabricated 1/2" copper tube • included: quarter turn stops and plugs 	U140XS-PF	111.70	1/2" Crimp Ring PEX	6	
		U140CXS-PF	111.70	1/2" Cold Exp. PEX	6	
 <ul style="list-style-type: none"> • shower only application • ports: three 	<ul style="list-style-type: none"> • shower only application • ports: three 	U130CI	71.20	1/2" CC/IPS	6	
		U130X	71.20	1/2" Crimp Ring PEX	6	
		U130CX	71.20	1/2" Cold Exp. PEX	6	
 <ul style="list-style-type: none"> • shower only application • ports: three • quarter turn stops: included 	<ul style="list-style-type: none"> • shower only application • ports: three • quarter turn stops: included 	U130CIS	102.45	1/2" CC/IPS	6	
		U130XS	102.45	1/2" Crimp Ring PEX	6	
		U130CXS	102.45	1/2" Cold Exp. PEX	6	
<p>Four port valves can be used with either Tub/Shower or Shower Only applications. Three port valves can ONLY be used with Shower Only applications. For more product details, reference pages 465-466 in valve section.</p>						
<p>HOW TO ORDER VALVES: PAGES 465-466</p>		 <p>TRIM PART #</p>	+	 <p>VALVE PART #</p>	=	 <p>COMPLETE FAUCET</p>



		MODEL	LIST	FINISH/CONNECT	CASE QTY	
POSI-TEMP® TUB/SHOWER TRIM						
 <ul style="list-style-type: none"> • showerhead: single-function eco-performance rainshower • showerhead size: 8" diameter • tub spout length: 7" • tub spout connection type: slip fit • tub spout type: diverter • valve: sold separately 		1.75 GPM (6.65 L/min) max.				
		T2233EP	186.85	Chrome	4	
		T2233EPBN	313.10	Brushed Nickel	4	
		T2233EPORB	339.05	Oil Rubbed Bronze	4	
 <ul style="list-style-type: none"> • showerhead: single-function standard • showerhead size: 3-1/2" diameter • tub spout length: 7" • tub spout connection type: slip fit • tub spout type: diverter • valve: sold separately 		2.5 GPM (9.5 L/min) max.				
		T2133◆	135.80	Chrome	3	
		T2133BN	264.90	Brushed Nickel	3	
		T2133ORB	291.40	Oil Rubbed Bronze	3	
 <ul style="list-style-type: none"> • showerhead: single-function eco-performance • showerhead size: 3-1/2" diameter • tub spout length: 7" • tub spout connection type: slip fit • tub spout type: diverter • used to replace: 2 or 3 hole shower valve • valve: sold separately 		1.75 GPM (6.65 L/min) max.				
		T2137EP	166.65	Chrome	3	
		T2137EPBN	306.45	Brushed Nickel	3	
		T2137EPORB	339.05	Oil Rubbed Bronze	3	
 <ul style="list-style-type: none"> • showerhead: five-function standard • showerhead size: 4" diameter • tub spout length: 7" • tub spout connection type: slip fit • tub spout type: diverter • used to replace: 2 or 3 hole shower valve • valve: sold separately 		2.5 GPM (9.5 L/min) max.				
		T2139	186.85	Chrome	3	
		T2139BN	313.10	Brushed Nickel	3	
		1.75 GPM (6.65 L/min) max.				
		T2139EP	186.85	Chrome	3	
		T2139EPBN	313.10	Brushed Nickel	3	
 <ul style="list-style-type: none"> • showerhead: single-function eco-performance • showerhead size: 3-1/2" diameter • tub spout length: 7" • tub spout connection type: slip fit • tub spout type: diverter • chrome sold in case qty only: no single pack • valve: sold separately 		1.75 GPM (6.65 L/min) max.				
		T62133EP◆◆	116.60	Chrome	12	
		T2133EPBN	264.90	Brushed Nickel	3	
		T2133EPORB	291.40	Oil Rubbed Bronze	3	
POSI-TEMP® SHOWER MIXING VALVES						
 <ul style="list-style-type: none"> • tub/shower or shower only application • ports: four with adjustable temp. limit stops • test plug: included 		2520◆	156.10	1/2" CC	6	
		2510◆	156.10	1/2" IPS	6	
 <ul style="list-style-type: none"> • tub/shower or shower only application • ports: four with adjustable temp. limit stops • quarter turn stops: included • test plug: included 		2570◆	189.55	1/2" CC	6	
		2590◆	189.55	1/2" IPS	6	
		2580◆	156.10	1/2" Crimp ring PEX	6	
 <ul style="list-style-type: none"> • tub/shower only application • ports: four with adjustable temp. limit stops • quarter turn stops: included • test plug: included 		2360PF	208.45	1/2" Crimp Ring PEX	3	
		2385PF	208.45	1/2" Cold Exp. PEX	3	
 <ul style="list-style-type: none"> • shower only application • ports: three with adjustable temp. limit stops • quarter turn stops: included • test plug: included 		2326PF	201.20	1/2" Crimp Ring PEX	6	
		2328PF	201.20	1/2" Cold Exp. PEX	6	
<p>Four port valves can be used with either Tub/Shower or Shower Only applications. Three port valves can ONLY be used with Shower Only applications. For more product details, reference page 467-468 in valve section.</p>						
<p>HOW TO ORDER VALVES: PAGES 467-470</p>		 <p>TRIM PART #</p>	+	 <p>VALVE PART #</p>	=	 <p>COMPLETE FAUCET</p>

		MODEL	LIST	FINISH/CONNECT	CASE QTY						
POSI-TEMP® SHOWER ONLY TRIM											
 <ul style="list-style-type: none"> • showerhead: single-function eco-performance rainshower • showerhead size: 8" diameter • valve: sold separately 		1.75 GPM (6.65 L/min) max.									
		T2232EP	145.25	Chrome	4						
		T2232EPBN	250.45	Brushed Nickel	4						
		T2232EPORB	270.00	Oil Rubbed Bronze	4						
 <ul style="list-style-type: none"> • showerhead: single-function standard • showerhead size: 3-1/2" diameter • valve: sold separately 		2.5 GPM (9.5 L/min) max.									
		T2132◆	93.35	Chrome	3						
		T2132BN	200.85	Brushed Nickel	3						
		T2132ORB	220.85	Oil Rubbed Bronze	3						
 <ul style="list-style-type: none"> • showerhead: five-function standard • showerhead size: 4" diameter • used to replace: 2 or 3 hole shower valve • valve: sold separately 		2.5 GPM (9.5 L/min) max.									
		T2138	145.25	Chrome	3						
		T2138BN	250.45	Brushed Nickel	3						
		1.75 GPM (6.65 L/min) max.									
		T2138EP	145.25	Chrome	3						
		T2138EPBN	250.45	Brushed Nickel	3						
 <ul style="list-style-type: none"> • showerhead: single-function eco-performance • showerhead size: 3-1/2" diameter • chrome sold in case qty only: no single pack • valve: sold separately 		1.75 GPM (6.65 L/min) max.									
		T62132EP◆◆	77.40	Chrome	12						
		T2132EPBN	200.85	Brushed Nickel	3						
		T2132EPORB	220.85	Oil Rubbed Bronze	3						
POSI-TEMP® VALVE ONLY TRIM											
 <ul style="list-style-type: none"> • valve: sold separately 		T2131	71.15	Chrome	3						
		T2131BN	162.55	Brushed Nickel	3						
		T2131ORB	178.70	Oil Rubbed Bronze	3						
		POSI-TEMP® SHOWER MIXING VALVES									
 <ul style="list-style-type: none"> • tub/shower or shower only application • ports: four with adjustable temp. limit stops • test plug: included 		2520◆	156.10	1/2" CC	6						
		2510◆	156.10	1/2" IPS	6						
 <ul style="list-style-type: none"> • tub/shower or shower only application • ports: four with adjustable temp. limit stops • quarter turn stops: included • test plug: included 		2570◆	189.55	1/2" CC	6						
		2590◆	189.55	1/2" IPS	6						
		2580◆	156.10	1/2" Crimp ring PEX	6						
		 <ul style="list-style-type: none"> • tub/shower only application • ports: two with adjustable temp. limit stops • quarter turn stops: included • test plug: included 		2360PF	208.45	1/2" Crimp Ring PEX	3				
2385PF	208.45			1/2" Cold Exp. PEX	3						
 <ul style="list-style-type: none"> • shower only application • ports: three with adjustable temp. limit stops • quarter turn stops: included • test plug: included 		2326PF	201.20	1/2" Crimp Ring PEX	6						
		2328PF	201.20	1/2" Cold Exp. PEX	6						
<p>Four port valves can be used with either Tub/Shower or Shower Only applications. Three port valves can ONLY be used with Shower Only applications. For more product details, reference page 467-468 in valve section.</p>											
<p>HOW TO ORDER VALVES: PAGES 467-470</p>		 <p>TRIM PART #</p>				+	 <p>VALVE PART #</p>		=	 <p>COMPLETE FAUCET</p>	



	MODEL	LIST	FINISH/CONNECT	CASE QTY
TWO-HANDLE BIDET FAUCET TRIM				
 <ul style="list-style-type: none"> center dimensions: 8" - 16" center valve: sold separately 	T5220	471.55	Chrome	3
	T5220BN	569.35	Brushed Nickel	3
BIDET VALVE				
 <ul style="list-style-type: none"> application: three hole center dimensions: 8" - 16" center 	9265	321.95	1/2" IPS	6
<p>HOW TO ORDER VALVES: PAGE 471</p> <div style="display: flex; align-items: center; justify-content: center;">  TRIM PART # +  VALVE PART # =  COMPLETE FAUCET </div>				

Moen® bath accessories CANNOT be combined with Moen faucet parts on a Purchase Order.

A PERFECT MATCH

A line of perfectly matching accessories - including tank levers and towel bars - allow for a completely cohesive look in the bath.

MODEL NUMBER	LIST EACH	DESCRIPTION	QTY
Chrome (CH)			
YB2801CH	25.00	Tank Lever	6
YB2803CH	18.65	Single Robe Hook	24
YB2808CH	33.25	Paper Holder	6
YB2818CH	40.80	18" Towel Bar	6
YB2824CH	43.05	24" Towel Bar	6
YB2886CH	25.40	Towel Ring	6
YB2894CH	198.45	Towel Shelf	2
Brushed Nickel (BN)			
YB2801BN	40.10	Tank Lever	6
YB2803BN	28.40	Single Robe Hook	24
YB2808BN	51.15	Paper Holder	6
YB2818BN	62.70	18" Towel Bar	6
YB2824BN	65.95	24" Towel Bar	6
YB2886BN	38.65	Towel Ring	6
YB2894BN	217.65	Towel Shelf	2
Oil Rubbed Bronze (ORB)			
YB2801ORB	44.15	Tank Lever	6
YB2803ORB	31.20	Single Robe Hook	24
YB2808ORB	56.15	Paper Holder	6
YB2818ORB	68.90	18" Towel Bar	6
YB2824ORB	72.40	24" Towel Bar	6
YB2886ORB	42.65	Towel Ring	6
YB2894ORB	239.35	Towel Shelf	2
Pro-Fit® Installation Mounting Template			
YB8081	14.90	Pro-Fit® Installation Mounting Template	25



Tank Lever
YB2801



Single Robe Hook
YB2803



Towel Ring
YB2886



Paper Holder
YB2808



18" Towel Bar
YB2818



Towel Shelf
YB2894

24" Towel Bar
YB2824



YB8081
Pro-Fit® Installation Mounting Template
(See page 480 for more information about the Pro-Fit® Installation System.)

GRAB BARS

MODEL NUMBER	LIST EACH	DESCRIPTION	QTY
1½" • Chrome (CH)			
YG2812CH	109.65	12" Designer Grab Bar	6
YG2818CH	115.90	18" Designer Grab Bar	6
YG2824CH	121.40	24" Designer Grab Bar	6
1½" • Brushed Nickel (BN)			
YG2812BN	133.75	12" Designer Grab Bar	6
YG2818BN	140.50	18" Designer Grab Bar	6
YG2824BN	152.05	24" Designer Grab Bar	6
1½" • Oil Rubbed Bronze (ORB)			
YG2812ORB	146.25	12" Designer Grab Bar	6
YG2818ORB	153.70	18" Designer Grab Bar	6
YG2824ORB	169.65	24" Designer Grab Bar	6

SECUREMOUNT™

- SecureMount™ Grab Bars are manufactured with an innovative flange design that makes it easy to connect to the stud at multiple points.
- Tested to withstand 500lbs.
- To install grab bars securely without studs, use SecureMount™ Anchors. Sold separately.



24" Designer Grab Bar
YG2824

Complies with Americans with Disabilities Act (ADA) specifications. SecureMount™ Grab Bars are tested to withstand 500 lb. pull when securely installed per instructions.

List price is per each (unless otherwise noted). Product can be ordered by case quantity or individually. For more information on ordering bath accessories, contact Moen Bath Accessory Customer Service at 800-882-0116, contact your local Moen sales representative, or visit us at www.moen.com.





LIGHTING

MODEL NUMBER	LIST EACH	DESCRIPTION	QTY
Chrome (CH)			
YB2861CH	147.20	One Globe Bath Light	2
YB2862CH	206.10	Two Globe Bath Light	2
YB2863CH	255.90	Three Globe Bath Light	2
YB2864CH	327.80	Four Globe Bath Light	2
Brushed Nickel (BN)			
YB2861BN	184.10	One Globe Bath Light	2
YB2862BN	257.70	Two Globe Bath Light	2
YB2863BN	319.95	Three Globe Bath Light	2
YB2864BN	409.65	Four Globe Bath Light	2
Oil Rubbed Bronze (ORB)			
YB2861ORB	184.10	One Globe Bath Light	2
YB2862ORB	257.70	Two Globe Bath Light	2
YB2863ORB	319.95	Three Globe Bath Light	2
YB2864ORB	409.65	Four Globe Bath Light	2
Replacement Globe			
YB2869	27.60	Replacement Globe	3



One Globe Bath Light
YB2861



Two Globe Bath Light
YB2862



Three Globe Bath Light
YB2863



Four Globe Bath Light
YB2864



Replacement Globe
YB2869



Bulbs not included.
List price is per each (unless otherwise noted).
Product can be ordered by case quantity or individually.
All Eva® lighting Fixtures can be mounted facing either upward or downward.

MODEL LIST FINISH/CONNECT CASE QTY

ONE-HANDLE BATHROOM FAUCET



DECKPLATE
SOLD
SEPARATELY





































- application: one hole
- center dimensions: 4" center
- supply lines: flexible
- connection: 3/8" compression
- deckplate: sold separately
- drain assembly: metal with lift rod
- red/blue markings: included























DURALAST®

MODEL	LIST	FINISH/CONNECT	CASE QTY
1.2 GPM (4.5L/min) max.			
6710	274.50	Chrome	3
OPTIONAL DECKPLATE SOLD SEPARATELY			
172666	19.10	Chrome	20



		MODEL	LIST	FINISH/CONNECT	CASE QTY
M-CORE® 2-SERIES TUB/SHOWER TRIM					
	<ul style="list-style-type: none"> • showerhead: single-function eco-performance • showerhead size: 3.75" diameter • tub spout length: 6" • tub spout connection type: slip fit • tub spout type: diverter • red/blue markings: included • includes: pressure balanced cartridge with temperature control • valve: sold separately 	<p> 1.75 GPM (6.65 L/min) max.</p> <p>UT2663EP</p>	234.25	Chrome	12
	<ul style="list-style-type: none"> • showerhead type: showerhead sold separately • tub spout length: 6" • tub spout connection type: slip fit • tub spout type: diverter • red/blue markings: included • includes: pressure balanced cartridge with temperature control • valve: sold separately 	UT2663NH	217.85	Chrome	3
M-CORE® 2-SERIES SHOWER ONLY TRIM					
	<ul style="list-style-type: none"> • showerhead: single-function eco-performance • showerhead size: 3.75" diameter • red/blue markings: included • includes: pressure balanced cartridge with temperature control • valve: sold separately 	<p> 1.75 GPM (6.65 L/min) max.</p> <p>UT2662EP</p>	195.95	Chrome	1
	<ul style="list-style-type: none"> • showerhead type: showerhead sold separately • red/blue markings: included • includes: pressure balanced cartridge with temperature control • valve: sold separately 	UT2662NH	192.20	Chrome	3
M-CORE® MIXING SHOWER VALVE					
	<ul style="list-style-type: none"> • tub/shower or shower only application • ports: four with adj. temp. limit stops • included: test plug and cross flow plug 	<p>U140CI</p> <p>U140X</p> <p>U140CX</p> <p>U140V</p>	71.20	1/2" CC/IPS	6
	<ul style="list-style-type: none"> • tub/shower or shower only application • ports: four with adj. temp. limit stops • quarter turn stops: included 	<p>U140CIS</p> <p>U140XS</p> <p>U140CXCS</p> <p>U140VS</p>	102.45	1/2" CC/IPS	6
	<ul style="list-style-type: none"> • tub/shower only application • ports: four with adj. temp. limit stops • tub outlet: pre-fabricated 1/2" copper tube • included: quarter turn stops and plugs 	<p>U140X-PF</p> <p>U140CX-PF</p>	80.40	1/2" Crimp Ring PEX	6
	<ul style="list-style-type: none"> • tub/shower only application • ports: four with adj. temp. limit stops • tub outlet: pre-fabricated 1/2" copper tube • included: quarter turn stops and plugs 	<p>U140XS-PF</p> <p>U140CXCS-PF</p>	111.70	1/2" Crimp Ring PEX	6
	<ul style="list-style-type: none"> • shower only application • ports: three 	<p>U130CI</p> <p>U130X</p> <p>U130CX</p>	71.20	1/2" CC/IPS	6
	<ul style="list-style-type: none"> • shower only application • ports: three • quarter turn stops: included 	<p>U130CIS</p> <p>U130XS</p> <p>U130CXCS</p>	102.45	1/2" CC/IPS	6
<p>Four port valves can be used with either Tub/Shower or Shower Only applications. Three port valves can ONLY be used with Shower Only applications. For more product details, reference pages 465-466 in valve section.</p>					
<p>HOW TO ORDER VALVES: PAGES 465-466</p>		<p>  TRIM PART #   VALVE PART #   COMPLETE FAUCET </p>			

		MODEL	LIST	FINISH/CONNECT	CASE QTY
M-CORE® 2-SERIES VALVE ONLY TRIM					
	<ul style="list-style-type: none"> • red/blue markings: included • includes: pressure balanced cartridge with temperature control • valve: sold separately 	UT2661	189.85	Chrome	3
M-CORE® MIXING SHOWER VALVE					
	<ul style="list-style-type: none"> • tub/shower or shower only application • ports: four with adj. temp. limit stops • included: test plug and cross flow plug 	U140CI 71.20 1/2" CC/IPS 6 U140X 71.20 1/2" Crimp Ring PEX + CC/IPS Tub 6 U140CX 71.20 1/2" Cold Exp. PEX + CC/IPS Tub 6 U140V 87.20 1/2" CPVC + CC/IPS Tub 6			
	<ul style="list-style-type: none"> • tub/shower or shower only application • ports: four with adj. temp. limit stops • quarter turn stops: included 	U140CIS 102.45 1/2" CC/IPS 6 U140XS 102.45 1/2" Crimp Ring PEX + CC/IPS Tub 6 U140CXS 102.45 1/2" Cold Exp. PEX + CC/IPS Tub 6 U140VS 118.50 1/2" CPVC + CC/IPS Tub 6			
	<ul style="list-style-type: none"> • tub/shower only application • ports: four with adj. temp. limit stops • tub outlet: pre-fabricated 1/2" copper tube • included: quarter turn stops and plugs 	U140X-PF 80.40 1/2" Crimp Ring PEX 6 U140CX-PF 80.40 1/2" Cold Exp. PEX 6			
	<ul style="list-style-type: none"> • tub/shower only application • ports: four with adj. temp. limit stops • tub outlet: pre-fabricated 1/2" copper tube • included: quarter turn stops and plugs 	U140XS-PF 111.70 1/2" Crimp Ring PEX 6 U140CXS-PF 111.70 1/2" Cold Exp. PEX 6			
	<ul style="list-style-type: none"> • shower only application • ports: three 	U130CI 71.20 1/2" CC/IPS 6 U130X 71.20 1/2" Crimp Ring PEX 6 U130CX 71.20 1/2" Cold Exp. PEX 6			
	<ul style="list-style-type: none"> • shower only application • ports: three • quarter turn stops: included 	U130CIS 102.45 1/2" CC/IPS 6 U130XS 102.45 1/2" Crimp Ring PEX 6 U130CXS 102.45 1/2" Cold Exp. PEX 6			
Four port valves can be used with either Tub/Shower or Shower Only applications. Three port valves can ONLY be used with Shower Only applications. For more product details, reference pages 465-466 in valve section.					
HOW TO ORDER VALVES: PAGES 465-466	 TRIM PART #	+	 VALVE PART #	=	 COMPLETE FAUCET

		MODEL	LIST	FINISH/CONNECT	CASE QTY	
POSI-TEMP® TUB/SHOWER TRIM						
  	<ul style="list-style-type: none"> • showerhead: single-function eco-performance • showerhead size: 3.75" diameter • tub spout length: 6" • tub spout connection type: slip fit • tub spout type: diverter • red/blue markings: included • valve: sold separately 	 1.75 GPM (6.65 L/min) max. T2663EP	114.10	Chrome	3	
		 				
POSI-TEMP® SHOWER ONLY TRIM						
 	<ul style="list-style-type: none"> • showerhead: single-function eco-performance • showerhead size: 3.75" diameter • red/blue markings: included • valve: sold separately 	 1.75 GPM (6.65 L/min) max. T2662EP	75.75	Chrome	3	
		 				
POSI-TEMP® SHOWER MIXING VALVES						
	<ul style="list-style-type: none"> • tub/shower or shower only application • ports: four with adjustable temp. limit stops • test plug: included 	2520 ◆	156.10	1/2" CC	6	
		2510 ◆	156.10	1/2" IPS	6	
	<ul style="list-style-type: none"> • tub/shower or shower only application • ports: four with adjustable temp. limit stops • quarter turn stops: included • test plug: included 	2570 ◆	189.55	1/2" CC	6	
		2590 ◆	189.55	1/2" IPS	6	
		2580 ◆	156.10	1/2" Crimp ring PEX	6	
	<ul style="list-style-type: none"> • tub/shower only application • ports: four with adjustable temp. limit stops • quarter turn stops: included • test plug: included 	2360PF	208.45	1/2" Crimp Ring PEX	3	
		2385PF	208.45	1/2" Cold Exp. PEX	3	
	<ul style="list-style-type: none"> • shower only application • ports: three with adjustable temp. limit stops • quarter turn stops: included • test plug: included 	2326PF	201.20	1/2" Crimp Ring PEX	6	
		2328PF	201.20	1/2" Cold Exp. PEX	6	
<p>Four port valves can be used with either Tub/Shower or Shower Only applications. Three port valves can ONLY be used with Shower Only applications. For more product details, reference page 467-468 in valve section.</p>						
<p>HOW TO ORDER VALVES: PAGES 467-470</p>		 <p>TRIM PART #</p>	+	 <p>VALVE PART #</p>	=	 <p>COMPLETE FAUCET</p>

Moen® bath accessories CANNOT be combined with Moen faucet parts on a Purchase Order.

COORDINATING ACCESSORIES

Perfectly suited styles for a cohesive look. From robe hooks to towel bars, paper holders to knobs and pulls, Moen offers a variety of coordinating accessories to complete any room.

MODEL NUMBER	LIST EACH	DESCRIPTION	QTY
Chrome (CH)			
BH3803CH	29.15	Single Robe Hook	12 ▲
Ⓟ BH3808CH	50.10	Pivoting Paper Holder	3 ▲
BH3818CH	50.50	18" Towel Bar	3 ▲
BH3824CH	54.80	24" Towel Bar	3 ▲
BH3886CH	40.20	Hand Towel Bar	3 ▲

Ⓟ Denotes pivoting paper holder



Single Robe Hook
BH3803



Pivoting Paper Holder
BH3808 | Ⓟ



Hand Towel Bar
BH3886



18" Towel Bar
BH3818

24" Towel Bar
BH3824

GRAB BARS ♿

MODEL NUMBER	LIST EACH	DESCRIPTION	QTY
1 1/4" • Chrome (CH)			
MBHG3818CH	141.40	18" Designer Grab Bar	3 ▲

SECUREMOUNT™

- SecureMount™ Grab Bars are manufactured with an innovative flange design that makes it easy to connect to the stud at multiple points.
- Tested to withstand 500lbs.
- To install grab bars securely without studs, use SecureMount™ Anchors. Sold separately.



18" Designer Grab Bar
MBHG3818





▲ **Retail Packaging**



- ♿ Complies with Americans with Disabilities Act (ADA) specifications. SecureMount™ Grab Bars are tested to withstand 500 lb. pull when securely installed per instructions.





List price is per each (unless otherwise noted). Product can be ordered by case quantity or individually. For more information on ordering bath accessories, contact Moen Bath Accessory Customer Service at **800-882-0116**, contact your local Moen sales representative, or visit us at www.moen.com.





GIBSON™ Collection

	MODEL	LIST	FINISH/CONNECT	CASE QTY
ONE-HANDLE BATHROOM FAUCET				
 DECKPLATE INCLUDED  <ul style="list-style-type: none"> • application: one or three hole • supply lines: flexible • connection: 3/8" compression • deckplate: included • drain assembly: metal with lift rod • red/blue markings: included <p> DURALAST®</p>	<p> 1.2 GPM (4.5L/min) max.</p>			
	6145	226.90	Chrome	3
	6145BN	306.30	Brushed Nickel	3
	6145BL	340.35	Matte Black	3



TWO-HANDLE CENTERSET BATHROOM FAUCET				
 <ul style="list-style-type: none"> • application: three hole • connection: 1/2" IPS • drain assembly: metal with lift rod <p> DURALAST®</p>	<p> 1.2 GPM (4.5L/min) max.</p>			
	6150	191.00	Chrome	3
	6150BN	257.85	Brushed Nickel	3
	6150BL	276.95	Matte Black	3



TWO-HANDLE WIDESPREAD BATHROOM FAUCET TRIM				
 <ul style="list-style-type: none"> • application: three hole • center dimensions: 8" - 16" center • drain assembly: metal with lift rod • red/blue markings: included • valve: sold separately <p> </p>	<p> 1.2 GPM (4.5L/min) max.</p>			
	T6142	209.30	Chrome	3
	T6142BN	313.95	Brushed Nickel	3
	T6142BL	345.30	Matte Black	3

WIDESPREAD FAUCET VALVE				
 <ul style="list-style-type: none"> • application: three hole • center dimensions: 8" - 16" center • drain assembly: metal with lift rod <p> DURALOCK® DURALAST®</p>	9000◆	162.15	1/2" IPS	6

HOW TO ORDER
VALVES: PAGE 463

 **TRIM PART #** +  **VALVE PART #** =  **COMPLETE FAUCET**











ONE-HANDLE WALLMOUNT TUB FILLER TRIM				
 <ul style="list-style-type: none"> • application: two hole • connection: 1/2" slip fit • tub spout type: non diverter • spout reach: 10.00" • includes: high flow volume control cartridge • WMV130 series valve kit: sold separately <p> </p>	WT961	474.10	Chrome	3
	WT961BN	616.35	Brushed Nickel	3
	WT961BL	678.00	Matte Black	3









ONE-HANDLE WALLMOUNT TUB FILLER VALVE KIT				
 <ul style="list-style-type: none"> • application: two hole with adj. center dimensions • ports: three • quarter turn stops: included • includes: test plug • includes: spout manifold <p></p>	WMV130CIS	151.05	1/2" CC/IPS	6
	WMV130XS	151.05	1/2" Crimp Ring PEX	6
	WMV130CXS	151.05	1/2" Cold Exp. PEX	6

HOW TO ORDER
VALVES: PAGE 463





















 **TRIM PART #** +  **VALVE PART #** =  **COMPLETE FAUCET**

GIBSON™























	MODEL	LIST	FINISH/CONNECT	CASE QTY	
TWO-HANDLE ROMAN TUB TRIM					
 <ul style="list-style-type: none"> • application: three hole • spout reach: 7.63" • valve: sold separately 	T961	341.55	Chrome	3	
	T961BN	496.55	Brushed Nickel	3	
	T961BL	546.20	Matte Black	3	
TWO-HANDLE ROMAN TUB VALVE					
 <ul style="list-style-type: none"> • deck thickness: 1/8" to 3-3/8" rough-in deck • adjustable spout shank: adjustable center dimensions 	4792	188.55	1/2" CC	6	
 <ul style="list-style-type: none"> • deck thickness: 1/8" to 2-3/4" rough-in deck • adjustable spout shank: 10" - 24" center dimensions 	4793	213.55	1/2" CPVC, Crimp Ring PEX	6	
	4794	203.60	1/2" Crimp Ring PEX, Cold Exp. PEX	6	
 <ul style="list-style-type: none"> • deck thickness: 1/8" to 3-3/16" rough-in deck • Non-adjustable spout shank: 10" center dimensions 	4796	177.65	1/2" CC	6	
	4797	181.10	1/2" CPVC, Crimp Ring PEX	6	
	4798	181.10	1/2" Crimp Ring PEX, Cold Exp. PEX	6	
For more product details, reference page 464 in valve section.					
HOW TO ORDER VALVES: PAGE 464	 TRIM PART #	+	 VALVE PART #	=	 COMPLETE FAUCET

M-CORE® TRANSFER VALVE TRIM					
 <ul style="list-style-type: none"> • use with the M-CORE® transfer valve • valve: sold separately 	UT2921	188.60	Chrome	12	
	UT2921BN	229.40	Brushed Nickel	12	
	UT2921BL	245.30	Matte Black	12	
M-CORE® TRANSFER VALVE					
Three Function (2 independent/1 shared) OR Six Function (3 independent/3 shared) - plumbing configuration page 472					
 <ul style="list-style-type: none"> • number of functions: three or six • ports: four 	U361CI	149.70	1/2" CC/IPS	6	
	U361CX	149.70	1/2" Cold Exp. PEX	6	
	U361X	149.70	1/2" Crimp Ring PEX	6	
Two Independent Functions OR Three Independent Functions - plumbing configurations page 472					
 <ul style="list-style-type: none"> • number of functions: two or three • ports: four 	U231CI	149.70	1/2" CC/IPS	6	
	U231CX	149.70	1/2" Cold Exp. PEX	6	
	U231X	149.70	1/2" Crimp Ring PEX	6	
For more product details, reference page 466 in valve section. See page 472 for plumbing configurations.					
HOW TO ORDER VALVES: PAGE 466	 TRIM PART #	+	 VALVE PART #	=	 COMPLETE FAUCET

GIBSON™ Collection













		MODEL	LIST	FINISH/CONNECT	CASE QTY						
M-CORE® 2-SERIES TUB/SHOWER TRIM											
	<ul style="list-style-type: none"> • showerhead: single-function eco-performance rainshower • showerhead size: 8" diameter • tub spout length: 6 1/2" • tub spout connection type: slip fit • tub spout type: diverter • red/blue markings: included • includes: pressure balanced cartridge with temperature control • valve: sold separately 	1.75 GPM (6.65 L/min) max.									
		UT3003EP	288.20	Chrome	4						
		UT3003EPBN	436.75	Brushed Nickel	4						
		UT3003EPBL	468.45	Matte Black	4						
	<ul style="list-style-type: none"> • showerhead: single-function eco-performance • showerhead size: 3.6" diameter • tub spout length: 6 1/2" • tub spout connection type: slip fit • tub spout type: diverter • red/blue markings: included • includes: pressure balanced cartridge with temperature control • valve: sold separately 	1.75 GPM (6.65 L/min) max.									
		UT2903EP	234.25	Chrome	12						
		UT2903EPBN	335.10	Brushed Nickel	12						
		UT2903EPBL	356.60	Matte Black	12						
	<ul style="list-style-type: none"> • showerhead type: showerhead sold separately • tub spout length: 6 1/2" • tub spout connection type: slip fit • tub spout type: diverter • red/blue markings: included • includes: pressure balanced cartridge with temperature control • valve: sold separately 	UT2903NH	217.85	Chrome	3						
		UT2903NHBN	315.05	Brushed Nickel	3						
		UT2903NHBL	334.55	Matte Black	3						
		M-CORE® MIXING SHOWER VALVE									
	<ul style="list-style-type: none"> • tub/shower or shower only application • ports: four with adj. temp. limit stops • included: test plug and cross flow plug 	U140CI	71.20	1/2" CC/IPS	6						
		U140X	71.20	1/2" Crimp Ring PEX + CC/IPS Tub	6						
		U140CX	71.20	1/2" Cold Exp. PEX + CC/IPS Tub	6						
		U140V	87.20	1/2" CPVC + CC/IPS Tub	6						
	<ul style="list-style-type: none"> • tub/shower or shower only application • ports: four with adj. temp. limit stops • quarter turn stops: included 	U140CIS	102.45	1/2" CC/IPS	6						
		U140XS	102.45	1/2" Crimp Ring PEX + CC/IPS Tub	6						
		U140CXS	102.45	1/2" Cold Exp. PEX + CC/IPS Tub	6						
		U140VS	118.50	1/2" CPVC + CC/IPS Tub	6						
	<ul style="list-style-type: none"> • tub/shower only application • ports: four with adj. temp. limit stops • tub outlet: pre-fabricated 1/2" copper tube • included: quarter turn stops and plugs 	U140X-PF	80.40	1/2" Crimp Ring PEX	6						
		U140CX-PF	80.40	1/2" Cold Exp. PEX	6						
	<ul style="list-style-type: none"> • tub/shower only application • ports: four with adj. temp. limit stops • tub outlet: pre-fabricated 1/2" copper tube • included: quarter turn stops and plugs 	U140XS-PF	111.70	1/2" Crimp Ring PEX	6						
		U140CXS-PF	111.70	1/2" Cold Exp. PEX	6						
	<ul style="list-style-type: none"> • shower only application • ports: three 	U130CI	71.20	1/2" CC/IPS	6						
		U130X	71.20	1/2" Crimp Ring PEX	6						
		U130CX	71.20	1/2" Cold Exp. PEX	6						
	<ul style="list-style-type: none"> • shower only application • ports: three • quarter turn stops: included 	U130CIS	102.45	1/2" CC/IPS	6						
		U130XS	102.45	1/2" Crimp Ring PEX	6						
		U130CXS	102.45	1/2" Cold Exp. PEX	6						
<p>Four port valves can be used with either Tub/Shower or Shower Only applications. Three port valves can ONLY be used with Shower Only applications. For more product details, reference pages 465-466 in valve section.</p>											
<p>HOW TO ORDER VALVES: PAGES 465-466</p>		 <p>TRIM PART #</p>				<p>+</p>	 <p>VALVE PART #</p>		<p>=</p>	 <p>COMPLETE FAUCET</p>	

GIBSON™











		MODEL	LIST	FINISH/CONNECT	CASE QTY						
M-CORE® 2-SERIES SHOWER ONLY TRIM											
 <ul style="list-style-type: none"> • showerhead: single-function eco-performance rainshower • showerhead size: 8" diameter • red/blue markings: included • includes: pressure balanced cartridge with temperature control • valve: sold separately 		1.75 GPM (6.65 L/min) max.									
		UT3002EP	249.80	Chrome	4						
		UT3002EPBN	350.60	Brushed Nickel	4						
		UT3002EPBL	373.55	Matte Black	4						
 <ul style="list-style-type: none"> • showerhead: single-function eco-performance • showerhead size: 3.6" diameter • red/blue markings: included • includes: pressure balanced cartridge with temperature control • valve: sold separately 		1.75 GPM (6.65 L/min) max.									
		UT2902EP	195.95	Chrome	12						
		UT2902EPBN	275.85	Brushed Nickel	12						
		UT2902EPBL	291.45	Matte Black	12						
 <ul style="list-style-type: none"> • showerhead type: showerhead sold separately • red/blue markings: included • includes: pressure balanced cartridge with temperature control • valve: sold separately 		UT2902NH	192.20	Chrome	3						
		UT2902NHBN	268.25	Brushed Nickel	3						
		UT2902NHBL	283.10	Matte Black	3						
	M-CORE® 2-SERIES VALVE ONLY TRIM										
 <ul style="list-style-type: none"> • red/blue markings: included • includes: pressure balanced cartridge with temperature control • valve: sold separately 		UT2901	189.85	Chrome	3						
		UT2901BN	263.35	Brushed Nickel	3						
		UT2901BL	277.70	Matte Black	3						
	M-CORE® MIXING SHOWER VALVE										
 <ul style="list-style-type: none"> • tub/shower or shower only application • ports: four with adj. temp. limit stops • included: test plug and cross flow plug 		U140CI	71.20	1/2" CC/IPS	6						
		U140X	71.20	1/2" Crimp Ring PEX + CC/IPS Tub	6						
		U140CX	71.20	1/2" Cold Exp. PEX + CC/IPS Tub	6						
		U140V	87.20	1/2" CPVC + CC/IPS Tub	6						
	 <ul style="list-style-type: none"> • tub/shower or shower only application • ports: four with adj. temp. limit stops • quarter turn stops: included 		U140CIS	102.45	1/2" CC/IPS	6					
		U140XS	102.45	1/2" Crimp Ring PEX + CC/IPS Tub	6						
		U140CXS	102.45	1/2" Cold Exp. PEX + CC/IPS Tub	6						
		U140VS	118.50	1/2" CPVC + CC/IPS Tub	6						
 <ul style="list-style-type: none"> • tub/shower only application • ports: four with adj. temp. limit stops • tub outlet: pre-fabricated 1/2" copper tube • included: quarter turn stops and plugs 			U140X-PF	80.40	1/2" Crimp Ring PEX	6					
		U140CX-PF	80.40	1/2" Cold Exp. PEX	6						
 <ul style="list-style-type: none"> • tub/shower only application • ports: four with adj. temp. limit stops • tub outlet: pre-fabricated 1/2" copper tube • included: quarter turn stops and plugs 		U140XS-PF	111.70	1/2" Crimp Ring PEX	6						
		U140CXS-PF	111.70	1/2" Cold Exp. PEX	6						
 <ul style="list-style-type: none"> • shower only application • ports: three 		U130CI	71.20	1/2" CC/IPS	6						
		U130X	71.20	1/2" Crimp Ring PEX	6						
		U130CX	71.20	1/2" Cold Exp. PEX	6						
 <ul style="list-style-type: none"> • shower only application • ports: three • quarter turn stops: included 		U130CIS	102.45	1/2" CC/IPS	6						
		U130XS	102.45	1/2" Crimp Ring PEX	6						
		U130CXS	102.45	1/2" Cold Exp. PEX	6						
<p>Four port valves can be used with either Tub/Shower or Shower Only applications. Three port valves can ONLY be used with Shower Only applications. For more product details, reference pages 465-466 in valve section.</p>											
<p>HOW TO ORDER VALVES: PAGES 465-466</p>		 <p>TRIM PART #</p>				<p>+</p>	 <p>VALVE PART #</p>		<p>=</p>	 <p>COMPLETE FAUCET</p>	















GIBSON™ Collection

		MODEL	LIST	FINISH/CONNECT	CASE QTY	
POSI-TEMP® TUB/SHOWER TRIM						
	<ul style="list-style-type: none"> • showerhead: single-function eco-performance rainshower • showerhead size: 8" diameter • tub spout length: 6 1/2" • tub spout connection type: slip fit • tub spout type: diverter • red/blue markings: included • valve: sold separately 	1.75 GPM (6.65 L/min) max.				
		T3003EP	168.00	Chrome	4	
		T3003EPBN	316.65	Brushed Nickel	4	
		T3003EPBL	348.35	Matte Black	4	
	<ul style="list-style-type: none"> • showerhead: single-function eco-performance • showerhead size: 3.6" diameter • tub spout length: 6 1/2" • tub spout connection type: slip fit • tub spout type: diverter • red/blue markings: included • valve: sold separately 	1.75 GPM (6.65 L/min) max.				
		T2903EP	114.10	Chrome	3	
		T2903EPBN	215.00	Brushed Nickel	3	
		T2903EPBL	236.55	Matte Black	3	
	<ul style="list-style-type: none"> • showerhead type: showerhead sold separately • tub spout length: 6 1/2" • tub spout connection type: slip fit • tub spout type: diverter • red/blue markings: included • valve: sold separately 	T2903NH	97.70	Chrome	3	
		T2903NHBN	194.90	Brushed Nickel	3	
		T2903NHBL	214.40	Matte Black	3	
		POSI-TEMP® SHOWER ONLY TRIM				
	<ul style="list-style-type: none"> • showerhead: single-function eco-performance rainshower • showerhead size: 8" diameter • red/blue markings: included • valve: sold separately 	1.75 GPM (6.65 L/min) max.				
		T3002EP	129.75	Chrome	4	
		T3002EPBN	230.40	Brushed Nickel	4	
		T3002EPBL	253.45	Matte Black	4	
	<ul style="list-style-type: none"> • showerhead: single-function eco-performance • showerhead size: 3.6" diameter • red/blue markings: included • valve: sold separately 	1.75 GPM (6.65 L/min) max.				
		T2902EP	75.75	Chrome	3	
		T2902EPBN	155.75	Brushed Nickel	3	
		T2902EPBL	171.35	Matte Black	3	
	<ul style="list-style-type: none"> • showerhead type: showerhead sold separately • red/blue markings: included • valve: sold separately 	T2902NH	72.05	Chrome	3	
		T2902NHBN	148.10	Brushed Nickel	3	
		T2902NHBL	162.90	Matte Black	3	
		POSI-TEMP® SHOWER MIXING VALVES				
	<ul style="list-style-type: none"> • tub/shower or shower only application • ports: four with adjustable temp. limit stops • test plug: included 	2520 ◆	156.10	1/2" CC	6	
		2510 ◆	156.10	1/2" IPS	6	
	<ul style="list-style-type: none"> • tub/shower or shower only application • ports: four with adjustable temp. limit stops • quarter turn stops: included • test plug: included 	2570 ◆	189.55	1/2" CC	6	
		2590 ◆	189.55	1/2" IPS	6	
		2580 ◆	156.10	1/2" Crimp ring PEX	6	
		POSI-TEMP® SHOWER MIXING VALVES				
	<ul style="list-style-type: none"> • tub/shower only application • ports: four with adjustable temp. limit stops • quarter turn stops: included • test plug: included 	2360PF	208.45	1/2" Crimp Ring PEX	3	
		2385PF	208.45	1/2" Cold Exp. PEX	3	
	<ul style="list-style-type: none"> • shower only application • ports: three with adjustable temp. limit stops • quarter turn stops: included • test plug: included 	2326PF	201.20	1/2" Crimp Ring PEX	6	
		2328PF	201.20	1/2" Cold Exp. PEX	6	
<p>Four port valves can be used with either Tub/Shower or Shower Only applications. Three port valves can ONLY be used with Shower Only applications. For more product details, reference page 467-468 in valve section.</p>						
<p>HOW TO ORDER VALVES: PAGES 467-470</p>		 <p>TRIM PART #</p>	+	 <p>VALVE PART #</p>	=	 <p>COMPLETE FAUCET</p>

GIBSON™

		MODEL	LIST	FINISH/CONNECT	CASE QTY	
POSI-TEMP® VALVE ONLY TRIM						
 <ul style="list-style-type: none"> • red/blue markings: included • valve: sold separately 		T2901	69.75	Chrome	3	
		T2901BN	143.20	Brushed Nickel	3	
		T2901BL	157.55	Matte Black	3	
POSI-TEMP® SHOWER MIXING VALVES						
 <ul style="list-style-type: none"> • tub/shower or shower only application • ports: four with adjustable temp. limit stops • test plug: included 		2520 ◆	156.10	1/2" CC	6	
		2510 ◆	156.10	1/2" IPS	6	
 <ul style="list-style-type: none"> • tub/shower or shower only application • ports: four with adjustable temp. limit stops • quarter turn stops: included • test plug: included 		2570 ◆	189.55	1/2" CC	6	
		2590 ◆	189.55	1/2" IPS	6	
		2580 ◆	156.10	1/2" Crimp ring PEX	6	
		2360PF	208.45	1/2" Crimp Ring PEX	3	
 <ul style="list-style-type: none"> • tub/shower only application • ports: four with adjustable temp. limit stops • quarter turn stops: included • test plug: included 		2385PF	208.45	1/2" Cold Exp. PEX	3	
		2326PF	201.20	1/2" Crimp Ring PEX	6	
 <ul style="list-style-type: none"> • shower only application • ports: three with adjustable temp. limit stops • quarter turn stops: included • test plug: included 		2328PF	201.20	1/2" Cold Exp. PEX	6	
<p>Four port valves can be used with either Tub/Shower or Shower Only applications. Three port valves can ONLY be used with Shower Only applications. For more product details, reference page 467-468 in valve section.</p>						
<p>HOW TO ORDER VALVES: PAGES 467-470</p>		 <p>TRIM PART #</p>	+	 <p>VALVE PART #</p>	=	 <p>COMPLETE FAUCET</p>

POSI-TEMP® WITH INTEGRATED TRANSFER VALVE TRIM						
 <ul style="list-style-type: none"> • red/blue markings: included • valve: sold separately 		T2900	103.50	Chrome	4	
		T2900BN	150.10	Brushed Nickel	4	
		T2900BL	165.15	Matte Black	4	
POSI-TEMP® WITH INTEGRATED TRANSFER VALVE						
 <ul style="list-style-type: none"> • functions: three (two independent and one shared) • ports: four with adjustable temp. limit stops • test plug: included 		2551	281.85	1/2" IPS	6	
		2581	317.40	1/2" IPS	6	
 <ul style="list-style-type: none"> • functions: three (two independent and one shared) • ports: four with adjustable temp. limit stops • stops: included • test plug: included 		2581	317.40	1/2" IPS	6	
		2521	281.85	1/2" IPS	6	
 <ul style="list-style-type: none"> • functions: two independent • ports: four with adjustable temp. limit stops • test plug: included 		2521	281.85	1/2" IPS	6	
		2571	317.40	1/2" IPS	6	
 <ul style="list-style-type: none"> • functions: two independent • ports: four with adjustable temp. limit stops • stops: included • test plug: included 		2571	317.40	1/2" IPS	6	
<p>For more product details, reference page 471 in valve section.</p>						
<p>HOW TO ORDER VALVES: PAGE 471</p>		 <p>TRIM PART #</p>	+	 <p>VALVE PART #</p>	=	 <p>COMPLETE FAUCET</p>

Moen® bath accessories CANNOT be combined with Moen faucet parts on a Purchase Order.

COORDINATING ACCESSORIES

Perfectly suited styles for a cohesive look. From robe hooks to towel bars, paper holders to knobs and pulls, Moen offers a variety of coordinating accessories to complete any room.

MODEL NUMBER	LIST EACH	DESCRIPTION	QTY
Chrome (CH)			
DN0703CH	25.40	Single Robe Hook	12 ▲
DN0705CH	10.95	Drawer Knob	48
DN0707CH	21.85	Drawer Pull	48
Ⓟ DN0708CH	50.00	Pivoting Paper Holder	3 ▲
DN0709CH	45.95	Single-Post Paper Holder	3
DN0718CH	46.00	18" Towel Bar	3 ▲
DN0722CH	75.00	24" Double Towel Bar	3 ▲
DN0724CH	50.00	24" Towel Bar	3 ▲
DN0786CH	32.45	Towel Ring	3 ▲
DN0790CH	90.65	Vanity Shelf	3 ▲
Ⓟ DN0792CH	121.30	Mirror	3 ▲
DN0794CH	212.20	Towel Shelf	2
Brushed Nickel (BN)			
DN0703BN	28.55	Single Robe Hook	24 ▲
DN0705BN	12.80	Drawer Knob	48
DN0707BN	23.55	Drawer Pull	48
Ⓟ DN0708BN	56.30	Pivoting Paper Holder	3
DN0709BN	51.40	Single-Post Paper Holder	3
DN0718BN	53.25	18" Towel Bar	3
DN0722BN	84.15	24" Double Towel Bar	3
DN0724BN	58.00	24" Towel Bar	3
DN0786BN	39.40	Towel Ring	3
DN0790BN	102.05	Vanity Shelf	3 ▲
Ⓟ DN0792BN	136.50	Mirror	3
DN0794BN	229.45	Towel Shelf	2
Matte Black (BL)			
DN0703BL	31.45	Single Robe Hook	12 ▲
DN0705BL	13.30	Drawer Knob	48
DN0707BL	26.40	Drawer Pull	48
Ⓟ DN0708BL	61.95	Pivoting Paper Holder	3 ▲
DN0709BL	56.55	Single-Post Paper Holder	3 ▲
DN0718BL	58.55	18" Towel Bar	3 ▲
DN0722BL	92.60	24" Double Towel Bar	3 ▲
DN0724BL	63.80	24" Towel Bar	3 ▲
DN0786BL	43.40	Towel Ring	3 ▲
DN0790BL	112.25	Vanity Shelf	3 ▲
Ⓟ DN0792BL	150.15	Mirror	3 ▲
DN0794BL	252.40	Towel Shelf	2 ▲
Brushed Gold (BG)			
DN0705BG	15.35	Drawer Knob	48
DN0707BG	28.20	Drawer Pull	48

Ⓟ Denotes pivoting paper holder and mirror



Single Robe Hook
DN0703



Towel Ring
DN0786



Pivoting Paper Holder
DN0708 | Ⓟ



Single-Post Paper Holder
DN0709



18" Towel Bar
DN0718



24" Double Towel Bar
DN0722

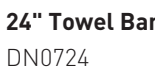

24" Towel Bar
DN0724



Drawer Knob
DN0705



Drawer Pull
DN0707



Towel Shelf
DN0794



Vanity Shelf
DN0790



Pivoting Mirror
DN0792 | Ⓟ

GIBSON™

▲ Retail Packaging

List price is per each (unless otherwise noted).
Product can be ordered by case quantity or individually.
For more information on ordering bath accessories, contact Moen Bath Accessory Customer Service at 800-882-0116, contact your local Moen sales representative, or visit us at www.moen.com.

GRAB BARS

MODEL NUMBER	LIST EACH	DESCRIPTION	QTY
1 1/4" • Chrome (CH)			
YG0712CH	84.45	12" Designer Grab Bar	6
YG0718CH	89.05	18" Designer Grab Bar	6
YG0724CH	93.65	24" Designer Grab Bar	6
YG0736CH	106.65	36" Designer Grab Bar	6
YG0742CH	156.75	42" Designer Grab Bar	6

1 1/4" • Brushed Nickel (BN)			
YG0712BN	94.75	12" Designer Grab Bar	6
YG0718BN	99.75	18" Designer Grab Bar	6
YG0724BN	104.80	24" Designer Grab Bar	6
YG0736BN	119.40	36" Designer Grab Bar	6
YG0742BN	176.75	42" Designer Grab Bar	6

1 1/4" • Matte Black (BL)			
YG0712BL	102.05	12" Designer Grab Bar	6
YG0718BL	107.70	18" Designer Grab Bar	6
YG0724BL	113.20	24" Designer Grab Bar	6
YG0736BL	128.90	36" Designer Grab Bar	6
YG0742BL	189.40	42" Designer Grab Bar	6

 Complies with Americans with Disabilities Act (ADA) specifications. SecureMount™ Grab Bars are tested to withstand 500 lb. pull when securely installed per instructions.

SECUREMOUNT™

- SecureMount™ Grab Bars are manufactured with an innovative flange design that makes it easy to connect to the stud at multiple points.
- Tested to withstand 500lbs.
- To install grab bars securely without studs, use SecureMount™ Anchors. Sold separately.



18" Designer Grab Bar
YG0718

LIGHTING

MODEL NUMBER	LIST EACH	DESCRIPTION	QTY
Chrome (CH)			
DN0761CH	146.85	One Globe Bath Light	2
DN0762CH	209.50	Two Globe Bath Light	2
DN0763CH	257.10	Three Globe Bath Light	2
DN0764CH	329.35	Four Globe Bath Light	2

Brushed Nickel (BN)			
DN0761BN	184.90	One Globe Bath Light	2
DN0762BN	258.90	Two Globe Bath Light	2
DN0763BN	321.45	Three Globe Bath Light	2
DN0764BN	411.55	Four Globe Bath Light	2

Brushed Gold (BG)			
DN0761BG	221.85	One Globe Bath Light	2
DN0762BG	310.60	Two Globe Bath Light	2
DN0763BG	385.70	Three Globe Bath Light	2
DN0764BG	493.85	Four Globe Bath Light	2

Matte Black (BL)			
DN0761BL	177.90	One Globe Bath Light	2
DN0762BL	253.75	Two Globe Bath Light	2
DN0763BL	311.35	Three Globe Bath Light	2
DN0764BL	398.85	Four Globe Bath Light	2

Replacement Globe			
DN0769	27.10	Replacement Globe	3



One Globe Bath Light
DN0761



Two Globe Bath Light
DN0762



Three Globe Bath Light
DN0763



Four Globe Bath Light
DN0764











Replacement Globe
DN0769





Bulbs not included.
List price is per each (unless otherwise noted).
Product can be ordered by case quantity or individually.
All ISO™ lighting Fixtures can be mounted facing either upward or downward.

GENTA™ LX Collection



	MODEL	LIST	FINISH/CONNECT	CASE QTY
ONE-HANDLE BATHROOM FAUCET				
 <p>DECKPLATE INCLUDED</p>  <ul style="list-style-type: none"> • application: one or three hole • supply lines: flexible • connection: 3/8" compression • deckplate: included • drain assembly: metal with lift rod • red/blue markings: included <p>  DURALAST®</p>	<p> 1.2 GPM (4.5L/min) max.</p>			
	6702	217.40	Chrome	3
	6702BN	282.65	Brushed Nickel	3
	6702BL	304.40	Matte Black	3



TWO-HANDLE WIDESPREAD BATHROOM FAUCET TRIM				
 <ul style="list-style-type: none"> • application: three hole • center dimensions: 8" - 16" center • drain assembly: metal with lift rod • valve: sold separately <p>  DURALAST®</p>	<p> 1.2 GPM (4.5L/min) max.</p>			
	T6708	176.15	Chrome	3
	T6708BN	237.80	Brushed Nickel	3
	T6708BL	255.40	Matte Black	3

WIDESPREAD FAUCET VALVE				
 <ul style="list-style-type: none"> • application: three hole • center dimensions: 8" - 16" center • drain assembly: metal with lift rod <p> DURALOCK®  DURALAST®</p>	9000◆	162.15	1/2" IPS	6

HOW TO ORDER
VALVES: PAGE 463

 **TRIM PART #** +  **VALVE PART #** =  **COMPLETE FAUCET**

ONE-HANDLE WALLMOUNT TUB FILLER TRIM				
 <ul style="list-style-type: none"> • application: two hole • connection: 1/2" slip fit • tub spout type: non diverter • spout reach: 10.00" • includes: high flow volume control cartridge • WMV130 series valve kit: sold separately <p> </p>	WT901	474.10	Chrome	3
	WT901BN	606.85	Brushed Nickel	3
	WT901BL	667.55	Matte Black	3









ONE-HANDLE WALLMOUNT TUB FILLER VALVE KIT				
 <ul style="list-style-type: none"> • application: two hole with adj. center dimensions • ports: three • quarter turn stops: included • includes: test plug • includes: spout manifold <p></p>	WMV130CIS	151.05	1/2" CC/IPS	6
	WMV130XS	151.05	1/2" Crimp Ring PEX	6
	WMV130CXS	151.05	1/2" Cold Exp. PEX	6

HOW TO ORDER
VALVES: PAGE 463









 **TRIM PART #** +  **VALVE PART #** =  **COMPLETE FAUCET**

GENTA™ LX





















GENTA™ LX Collection

	MODEL	LIST	FINISH/CONNECT	CASE QTY
TWO-HANDLE ROMAN TUB TRIM				
 <ul style="list-style-type: none"> • application: three hole • spout reach: 7.94" • valve: sold separately 	T908	349.00	Chrome	3
	T908BN	522.10	Brushed Nickel	3
	T908BL	574.35	Matte Black	3
TWO-HANDLE ROMAN TUB VALVE				
 <ul style="list-style-type: none"> • deck thickness: 1/8" to 3-3/8" rough-in deck • adjustable spout shank: adjustable center dimensions 	4792	188.55	1/2" CC	6
 <ul style="list-style-type: none"> • deck thickness: 1/8" to 2-3/4" rough-in deck • adjustable spout shank: 10" - 24" center dimensions 	4793	213.55	1/2" CPVC, Crimp Ring PEX	6
	4794	203.60	1/2" Crimp Ring PEX, Cold Exp. PEX	6
 <ul style="list-style-type: none"> • deck thickness: 1/8" to 3-3/16" rough-in deck • Non-adjustable spout shank: 10" center dimensions 	4796	177.65	1/2" CC	6
	4797	181.10	1/2" CPVC, Crimp Ring PEX	6
	4798	181.10	1/2" Crimp Ring PEX, Cold Exp. PEX	6
For more product details, reference page 464 in valve section.				
HOW TO ORDER VALVES: PAGE 464				

















GENTA™ LX Collection

		MODEL	LIST	FINISH/CONNECT	CASE QTY
M-CORE® TRANSFER VALVE TRIM					
 <ul style="list-style-type: none"> • use with the M-CORE® transfer valve • valve: sold separately 		UT2401	183.70	Chrome	12
		UT2401BN	229.05	Brushed Nickel	12
		UT2401BL	244.80	Matte Black	12
M-CORE® TRANSFER VALVE					
Three Function (2 independent/1 shared) OR Six Function (3 independent/3 shared) - plumbing configuration page 472					
 <ul style="list-style-type: none"> • number of functions: three or six • ports: four 		U361CI	149.70	1/2" CC/IPS	6
		U361CX	149.70	1/2" Cold Exp. PEX	6
		U361X	149.70	1/2" Crimp Ring PEX	6
Two Independent Functions OR Three Independent Functions - plumbing configurations page 472					
 <ul style="list-style-type: none"> • number of functions: two or three • ports: four 		U231CI	149.70	1/2" CC/IPS	6
		U231CX	149.70	1/2" Cold Exp. PEX	6
		U231X	149.70	1/2" Crimp Ring PEX	6
For more product details, reference page 466 in valve section. See page 472 for plumbing configurations.					
HOW TO ORDER VALVES: PAGE 466	 TRIM PART #	+	 VALVE PART #	=	 COMPLETE FAUCET

































GENTA™ LX Collection

		MODEL	LIST	FINISH/CONNECT	CASE QTY	
M-CORE® 2-SERIES TUB/SHOWER TRIM						
  	<ul style="list-style-type: none"> • showerhead: six-function eco-performance • showerhead size: 4.5" diameter • tub spout length: 7" • tub spout connection type: slip fit • tub spout type: diverter • red/blue markings: included • includes: pressure balanced cartridge with temperature control • valve: sold separately 	1.75 GPM (6.65 L/min) max.				
		UT2473EP	229.50	Chrome	12	
		UT2473EPBN	330.35	Brushed Nickel	12	
		UT2473EPBL	351.35	Matte Black	12	
M-CORE® 2-SERIES SHOWER ONLY TRIM						
  	<ul style="list-style-type: none"> • showerhead type: showerhead sold separately • tub spout length: 7" • tub spout connection type: slip fit • tub spout type: diverter • red/blue markings: included • includes: pressure balanced cartridge with temperature control • valve: sold separately 	1.75 GPM (6.65 L/min) max.				
		UT2473NH	213.80	Chrome	3	
		UT2473NHBN	306.55	Brushed Nickel	3	
		UT2473NHBL	325.15	Matte Black	3	
M-CORE® 2-SERIES SHOWER ONLY TRIM						
  	<ul style="list-style-type: none"> • showerhead: six-function eco-performance • showerhead size: 4.5" diameter • red/blue markings: included • includes: pressure balanced cartridge with temperature control • valve: sold separately 	1.75 GPM (6.65 L/min) max.				
		UT2472EP	192.80	Chrome	12	
		UT2472EPBN	269.00	Brushed Nickel	12	
		UT2472EPBL	283.90	Matte Black	12	
  	<ul style="list-style-type: none"> • showerhead type: showerhead sold separately • red/blue markings: included • includes: pressure balanced cartridge with temperature control • valve: sold separately 	1.75 GPM (6.65 L/min) max.				
		UT2472NH	189.20	Chrome	3	
		UT2472NHBN	261.70	Brushed Nickel	3	
		UT2472NHBL	275.80	Matte Black	3	
M-CORE® MIXING SHOWER VALVE						
	<ul style="list-style-type: none"> • tub/shower or shower only application • ports: four with adj. temp. limit stops • included: test plug and cross flow plug 	U140CI	71.20	1/2" CC/IPS	6	
		U140X	71.20	1/2" Crimp Ring PEX + CC/IPS Tub	6	
		U140CX	71.20	1/2" Cold Exp. PEX + CC/IPS Tub	6	
		U140V	87.20	1/2" CPVC + CC/IPS Tub	6	
	<ul style="list-style-type: none"> • tub/shower or shower only application • ports: four with adj. temp. limit stops • quarter turn stops: included 	U140CIS	102.45	1/2" CC/IPS	6	
		U140XS	102.45	1/2" Crimp Ring PEX + CC/IPS Tub	6	
		U140CXS	102.45	1/2" Cold Exp. PEX + CC/IPS Tub	6	
		U140VS	118.50	1/2" CPVC + CC/IPS Tub	6	
	<ul style="list-style-type: none"> • tub/shower only application • ports: four with adj. temp. limit stops • tub outlet: pre-fabricated 1/2" copper tube • included: quarter turn stops and plugs 	U140X-PF	80.40	1/2" Crimp Ring PEX	6	
		U140CX-PF	80.40	1/2" Cold Exp. PEX	6	
	<ul style="list-style-type: none"> • tub/shower only application • ports: four with adj. temp. limit stops • tub outlet: pre-fabricated 1/2" copper tube • included: quarter turn stops and plugs 	U140XS-PF	111.70	1/2" Crimp Ring PEX	6	
		U140CXS-PF	111.70	1/2" Cold Exp. PEX	6	
	<ul style="list-style-type: none"> • shower only application • ports: three 	U130CI	71.20	1/2" CC/IPS	6	
		U130X	71.20	1/2" Crimp Ring PEX	6	
		U130CX	71.20	1/2" Cold Exp. PEX	6	
	<ul style="list-style-type: none"> • shower only application • ports: three • quarter turn stops: included 	U130CIS	102.45	1/2" CC/IPS	6	
		U130XS	102.45	1/2" Crimp Ring PEX	6	
		U130CXS	102.45	1/2" Cold Exp. PEX	6	
<p>Four port valves can be used with either Tub/Shower or Shower Only applications. Three port valves can ONLY be used with Shower Only applications. For more product details, reference pages 465-466 in valve section.</p>						
HOW TO ORDER VALVES: PAGES 465-466		 TRIM PART #	+	 VALVE PART #	=	 COMPLETE FAUCET

GENTA™ LX Collection















		MODEL	LIST	FINISH/CONNECT	CASE QTY	
M-CORE® 2-SERIES VALVE ONLY TRIM						
 <ul style="list-style-type: none"> • red/blue markings: included • includes: pressure balanced cartridge with temperature control • valve: sold separately 		U12471	186.90	Chrome	3	
		U12471BN	257.00	Brushed Nickel	3	
		U12471BL	270.75	Matte Black	3	
M-CORE® MIXING SHOWER VALVE						
 <ul style="list-style-type: none"> • tub/shower or shower only application • ports: four with adj. temp. limit stops • included: test plug and cross flow plug 		U140CI	71.20	1/2" CC/IPS	6	
		U140X	71.20	1/2" Crimp Ring PEX + CC/IPS Tub	6	
		U140CX	71.20	1/2" Cold Exp. PEX + CC/IPS Tub	6	
		U140V	87.20	1/2" CPVC + CC/IPS Tub	6	
 <ul style="list-style-type: none"> • tub/shower or shower only application • ports: four with adj. temp. limit stops • quarter turn stops: included 		U140CIS	102.45	1/2" CC/IPS	6	
		U140XS	102.45	1/2" Crimp Ring PEX + CC/IPS Tub	6	
		U140CXS	102.45	1/2" Cold Exp. PEX + CC/IPS Tub	6	
		U140VS	118.50	1/2" CPVC + CC/IPS Tub	6	
 <ul style="list-style-type: none"> • tub/shower only application • ports: four with adj. temp. limit stops • tub outlet: pre-fabricated 1/2" copper tube • included: quarter turn stops and plugs 		U140X-PF	80.40	1/2" Crimp Ring PEX	6	
		U140CX-PF	80.40	1/2" Cold Exp. PEX	6	
 <ul style="list-style-type: none"> • tub/shower only application • ports: four with adj. temp. limit stops • tub outlet: pre-fabricated 1/2" copper tube • included: quarter turn stops and plugs 		U140XS-PF	111.70	1/2" Crimp Ring PEX	6	
		U140CXS-PF	111.70	1/2" Cold Exp. PEX	6	
 <ul style="list-style-type: none"> • shower only application • ports: three 		U130CI	71.20	1/2" CC/IPS	6	
		U130X	71.20	1/2" Crimp Ring PEX	6	
		U130CX	71.20	1/2" Cold Exp. PEX	6	
 <ul style="list-style-type: none"> • shower only application • ports: three • quarter turn stops: included 		U130CIS	102.45	1/2" CC/IPS	6	
		U130XS	102.45	1/2" Crimp Ring PEX	6	
		U130CXS	102.45	1/2" Cold Exp. PEX	6	
<p>Four port valves can be used with either Tub/Shower or Shower Only applications. Three port valves can ONLY be used with Shower Only applications. For more product details, reference pages 465-466 in valve section.</p>						
<p>HOW TO ORDER VALVES: PAGES 465-466</p>		 <p>TRIM PART #</p>	+	 <p>VALVE PART #</p>	=	 <p>COMPLETE FAUCET</p>

GENTA™ LX Collection

		MODEL	LIST	FINISH/CONNECT	CASE QTY	
POSI-TEMP® TUB/SHOWER TRIM						
  	<ul style="list-style-type: none"> • showerhead: six-function eco-performance • showerhead size: 4.5" diameter • tub spout length: 7" • tub spout connection type: slip fit • tub spout type: diverter • red/blue markings: included • valve: sold separately 	1.75 GPM (6.65 L/min) max.				
		T2473EP	109.30	Chrome	3	
		T2473EPBN	210.20	Brushed Nickel	3	
		T2473EPBL	231.15	Matte Black	3	
	 					
  	<ul style="list-style-type: none"> • showerhead type: showerhead sold separately • tub spout length: 7" • tub spout connection type: slip fit • tub spout type: diverter • red/blue markings: included • valve: sold separately 	T2473NH	93.75	Chrome	3	
		T2473NHBN	186.35	Brushed Nickel	3	
		T2473NHBL	205.05	Matte Black	3	
			 			
POSI-TEMP® SHOWER ONLY TRIM						
  	<ul style="list-style-type: none"> • showerhead: six-function eco-performance • showerhead size: 4.5" diameter • red/blue markings: included • valve: sold separately 	1.75 GPM (6.65 L/min) max.				
		T2472EP	72.65	Chrome	3	
		T2472EPBN	148.85	Brushed Nickel	3	
		T2472EPBL	163.80	Matte Black	3	
	 					
  	<ul style="list-style-type: none"> • showerhead type: showerhead sold separately • red/blue markings: included • valve: sold separately 	T2472NH	69.00	Chrome	3	
		T2472NHBN	141.50	Brushed Nickel	3	
		T2472NHBL	155.65	Matte Black	3	
			 			
POSI-TEMP® VALVE ONLY TRIM						
	<ul style="list-style-type: none"> • red/blue markings: included • valve: sold separately 	T2471	66.80	Chrome	3	
		T2471BN	136.85	Brushed Nickel	3	
		T2471BL	150.60	Matte Black	3	
			 			
POSI-TEMP® SHOWER MIXING VALVES						
	<ul style="list-style-type: none"> • tub/shower or shower only application • ports: four with adjustable temp. limit stops • test plug: included 	2520 ◆	156.10	1/2" CC	6	
		2510 ◆	156.10	1/2" IPS	6	
	<ul style="list-style-type: none"> • tub/shower or shower only application • ports: four with adjustable temp. limit stops • quarter turn stops: included • test plug: included 	2570 ◆	189.55	1/2" CC	6	
		2590 ◆	189.55	1/2" IPS	6	
		2580 ◆	156.10	1/2" Crimp ring PEX	6	
						
	<ul style="list-style-type: none"> • tub/shower only application • ports: four with adjustable temp. limit stops • quarter turn stops: included • test plug: included 	2360PF	208.45	1/2" Crimp Ring PEX	3	
		2385PF	208.45	1/2" Cold Exp. PEX	3	
	<ul style="list-style-type: none"> • shower only application • ports: three with adjustable temp. limit stops • quarter turn stops: included • test plug: included 	2326PF	201.20	1/2" Crimp Ring PEX	6	
		2328PF	201.20	1/2" Cold Exp. PEX	6	
						
<p>Four port valves can be used with either Tub/Shower or Shower Only applications. Three port valves can ONLY be used with Shower Only applications. For more product details, reference page 467-468 in valve section.</p>						
HOW TO ORDER VALVES: PAGES 467-470		 TRIM PART #	+	 VALVE PART #	=	 COMPLETE FAUCET



GENTA™ LX Collection

		MODEL	LIST	FINISH/CONNECT	CASE QTY
POSI-TEMP® WITH INTEGRATED TRANSFER VALVE TRIM					
 <ul style="list-style-type: none"> • red/blue markings: included • valve: sold separately  		T2470	99.15	Chrome	4
		T2470BN	143.75	Brushed Nickel	4
		T2470BL	154.85	Matte Black	4
POSI-TEMP® WITH INTEGRATED TRANSFER VALVE					
 <ul style="list-style-type: none"> • functions: three (two independent and one shared) • ports: four with adjustable temp. limit stops • test plug: included 		2551	281.85	1/2" IPS	6
 <ul style="list-style-type: none"> • functions: three (two independent and one shared) • ports: four with adjustable temp. limit stops • stops: included • test plug: included 		2581	317.40	1/2" IPS	6
 <ul style="list-style-type: none"> • functions: two independent • ports: four with adjustable temp. limit stops • test plug: included 		2521	281.85	1/2" IPS	6
 <ul style="list-style-type: none"> • functions: two independent • ports: four with adjustable temp. limit stops • stops: included • test plug: included 		2571	317.40	1/2" IPS	6
For more product details, reference page 471 in valve section.					
HOW TO ORDER VALVES: PAGE 471	 TRIM PART #	+	 VALVE PART #	=	 COMPLETE FAUCET

GENTATM LX Perfectly Matched Bath Accessories

Moen® bath accessories CANNOT be combined with Moen faucet parts on a Purchase Order.

A PERFECT MATCH

A line of perfectly matching accessories - including tank levers and towel bars - allow for a completely cohesive look in the bath.

MODEL NUMBER	LIST EACH	DESCRIPTION	QTY
Chrome (CH)			
BH3803CH	29.15	Single Robe Hook	12 ▲
Ⓟ BH3808CH	50.10	Pivoting Paper Holder	3 ▲
BH3818CH	50.50	18" Towel Bar	3 ▲
BH3824CH	54.80	24" Towel Bar	3 ▲
BH3886CH	40.20	Hand Towel Bar	3 ▲

Brushed Nickel (BN)			
BH3803BN	32.10	Single Robe Hook	24
Ⓟ BH3808BN	55.15	Pivoting Paper Holder	6
BH3818BN	55.55	18" Towel Bar	6
BH3824BN	60.25	24" Towel Bar	6
BH3886BN	44.25	Hand Towel Bar	6

Matte Black (BL)			
BH3803BL	35.35	Single Robe Hook	24
Ⓟ BH3808BL	60.65	Pivoting Paper Holder	6
BH3818BL	61.10	18" Towel Bar	6
BH3824BL	66.25	24" Towel Bar	6
BH3886BL	48.60	Hand Towel Bar	6

Ⓟ Denotes pivoting paper holder



Single Robe Hook
BH3803



Pivoting Paper Holder
BH3808 | Ⓟ



Hand Towel Bar
BH3886



18" Towel Bar
BH3818

24" Towel Bar
BH3824

GRAB BARS ♿

MODEL NUMBER	LIST EACH	DESCRIPTION	QTY
1 1/4" • Chrome (CH)			
MBHG3818CH	141.40	18" Designer Grab Bar	3 ▲
1 1/4" • Brushed Nickel (BN)			
MBHG3818BN	147.15	18" Designer Grab Bar	3 ▲

SECUREMOUNT™

- SecureMount™ Grab Bars are manufactured with an innovative flange design that makes it easy to connect to the stud at multiple points.
- Tested to withstand 500lbs.
- To install grab bars securely without studs, use SecureMount™ Anchors. Sold separately.

































18" Designer Grab Bar
MBHG3818





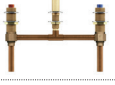











▲ **Retail Packaging**

















♿ Complies with Americans with Disabilities Act (ADA) specifications. SecureMount™ Grab Bars are tested to withstand 500 lb. pull when securely installed per instructions.





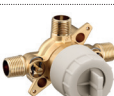







List price is per each (unless otherwise noted). Product can be ordered by case quantity or individually. For more information on ordering bath accessories, contact Moen Bath Accessory Customer Service at 800-882-0116, contact your local Moen sales representative, or visit us at www.moen.com.

		MODEL	LIST	FINISH/CONNECT	CASE QTY
ONE-HANDLE BATHROOM FAUCET					
	<ul style="list-style-type: none"> • application: three hole • center dimensions: 4" center • connection: 1/2" IPS • drain assembly: drain not included <p> DURALAST®</p>	<p> 1.2 GPM (4.5L/min) max.</p> <p>L4601◆</p>	172.25	Chrome	12
	<ul style="list-style-type: none"> • application: three hole • center dimensions: 4" center • connection: 1/2" IPS • drain assembly: drain not included • red/blue markings: included <p> DURALAST®</p>	<p> 1.2 GPM (4.5L/min) max.</p> <p>L4605</p>	172.25	Chrome	12
	<ul style="list-style-type: none"> • application: three hole • center dimensions: 4" center • connection: 1/2" IPS • drain assembly: metal with lift rod <p> DURALAST®</p>	<p> 1.2 GPM (4.5L/min) max.</p> <p>L4621◆</p>	212.80	Chrome	12
	<ul style="list-style-type: none"> • application: three hole • center dimensions: 4" center • supply line length: 16" • connection: 3/8" compression • drain assembly: metal with lift rod <p> DURALAST®</p>	<p> 1.2 GPM (4.5L/min) max.</p> <p>L4625◆</p>	212.80	Chrome	12
TWO-HANDLE CENTERSET BATHROOM FAUCET					
	<ul style="list-style-type: none"> • application: three hole • center dimensions: 4" center • connection: 1/2" IPS • drain assembly: metal with lift rod <p> DURALAST®</p>	<p> 1.2 GPM (4.5L/min) max.</p> <p>4925◆</p>	195.80	Chrome	12
TWO-HANDLE WIDESPREAD BATHROOM FAUCET					
	<ul style="list-style-type: none"> • application: three hole • center dimensions: 8" - 16" center • connection: 1/2" IPS • drain assembly: metal with lift rod • includes: 9000 valve <p> DURALOCK® DURALAST®</p>	<p> 1.2 GPM (4.5L/min) max.</p> <p>4945</p>	342.85	Chrome	6











	MODEL	LIST	FINISH/CONNECT	CASE QTY	
TWO-HANDLE ROMAN TUB TRIM					
 <ul style="list-style-type: none"> • application: three hole • spout reach: 9.00" • valve: sold separately 	T990	332.60	Chrome	6	
 <ul style="list-style-type: none"> • for garden tub application • application: three hole • spout reach: 7.00" • valve: sold separately 	T994	205.15	Chrome	6	
TWO-HANDLE ROMAN TUB VALVE					
 <ul style="list-style-type: none"> • deck thickness: 1/8" to 3-3/8" rough-in deck • adjustable spout shank: adjustable center dimensions  DURALAST®	4792	188.55	1/2" CC	6	
 <ul style="list-style-type: none"> • deck thickness: 1/8" to 2-3/4" rough-in deck • adjustable spout shank: 10" - 24" center dimensions  DURALOCK® DURALAST®	4793 4794	213.55 203.60	1/2" CPVC, Crimp Ring PEX 1/2" Crimp Ring PEX, Cold Exp. PEX	6 6	
 <ul style="list-style-type: none"> • deck thickness: 1/8" to 3-3/16" rough-in deck • Non-adjustable spout shank: 10" center dimensions  DURALAST®	4796 4797 4798	177.65 181.10 181.10	1/2" CC 1/2" CPVC, Crimp Ring PEX 1/2" Crimp Ring PEX, Cold Exp. PEX	6 6 6	
For more product details, reference page 464 in valve section.					
HOW TO ORDER VALVES: PAGE 464	 TRIM PART #	+	 VALVE PART #	=	 COMPLETE FAUCET











		MODEL	LIST	FINISH/CONNECT	CASE QTY
M-CORE® 2-SERIES TUB/SHOWER TRIM					
	<ul style="list-style-type: none"> • showerhead: single-function eco-performance • showerhead size: 2-1/2" diameter • tub spout length: 5 1/2" • tub spout connection type: slip fit • tub spout type: diverter • red/blue markings: included • includes: pressure balanced cartridge with temperature control • valve: sold separately 	<p> 1.75 GPM (6.65 L/min) max.</p> <p>UTL183EP</p>	188.30	Chrome	12
	<ul style="list-style-type: none"> • showerhead type: showerhead sold separately • tub spout length: 5 1/2" • tub spout connection type: slip fit • tub spout type: diverter • red/blue markings: included • includes: pressure balanced cartridge with temperature control • valve: sold separately 	UTL183NH	178.60	Chrome	12
M-CORE® 2-SERIES SHOWER ONLY TRIM					
	<ul style="list-style-type: none"> • showerhead: single-function eco-performance • showerhead size: 2-1/2" diameter • red/blue markings: included • includes: pressure balanced cartridge with temperature control • valve: sold separately 	<p> 1.75 GPM (6.65 L/min) max.</p> <p>UTL182EP</p>	157.75	Chrome	12
	<ul style="list-style-type: none"> • showerhead type: showerhead sold separately • red/blue markings: included • includes: pressure balanced cartridge with temperature control • valve: sold separately 	UTL182NH	155.15	Chrome	12
M-CORE® MIXING SHOWER VALVE					
	<ul style="list-style-type: none"> • tub/shower or shower only application • ports: four with adj. temp. limit stops • included: test plug and cross flow plug 	<p>U140CI</p> <p>U140X</p> <p>U140CX</p> <p>U140V</p>	<p>71.20</p> <p>71.20</p> <p>71.20</p> <p>87.20</p>	<p>1/2" CC/IPS</p> <p>1/2" Crimp Ring PEX + CC/IPS Tub</p> <p>1/2" Cold Exp. PEX + CC/IPS Tub</p> <p>1/2" CPVC + CC/IPS Tub</p>	<p>6</p> <p>6</p> <p>6</p> <p>6</p>
	<ul style="list-style-type: none"> • tub/shower or shower only application • ports: four with adj. temp. limit stops • quarter turn stops: included 	<p>U140CIS</p> <p>U140XS</p> <p>U140CXS</p> <p>U140VS</p>	<p>102.45</p> <p>102.45</p> <p>102.45</p> <p>118.50</p>	<p>1/2" CC/IPS</p> <p>1/2" Crimp Ring PEX + CC/IPS Tub</p> <p>1/2" Cold Exp. PEX + CC/IPS Tub</p> <p>1/2" CPVC + CC/IPS Tub</p>	<p>6</p> <p>6</p> <p>6</p> <p>6</p>
	<ul style="list-style-type: none"> • tub/shower only application • ports: four with adj. temp. limit stops • tub outlet: pre-fabricated 1/2" copper tube • included: quarter turn stops and plugs 	<p>U140X-PF</p> <p>U140CX-PF</p>	<p>80.40</p> <p>80.40</p>	<p>1/2" Crimp Ring PEX</p> <p>1/2" Cold Exp. PEX</p>	<p>6</p> <p>6</p>
	<ul style="list-style-type: none"> • tub/shower only application • ports: four with adj. temp. limit stops • tub outlet: pre-fabricated 1/2" copper tube • included: quarter turn stops and plugs 	<p>U140XS-PF</p> <p>U140CXS-PF</p>	<p>111.70</p> <p>111.70</p>	<p>1/2" Crimp Ring PEX</p> <p>1/2" Cold Exp. PEX</p>	<p>6</p> <p>6</p>
	<ul style="list-style-type: none"> • shower only application • ports: three 	<p>U130CI</p> <p>U130X</p> <p>U130CX</p>	<p>71.20</p> <p>71.20</p> <p>71.20</p>	<p>1/2" CC/IPS</p> <p>1/2" Crimp Ring PEX</p> <p>1/2" Cold Exp. PEX</p>	<p>6</p> <p>6</p> <p>6</p>
	<ul style="list-style-type: none"> • shower only application • ports: three • quarter turn stops: included 	<p>U130CIS</p> <p>U130XS</p> <p>U130CXS</p>	<p>102.45</p> <p>102.45</p> <p>102.45</p>	<p>1/2" CC/IPS</p> <p>1/2" Crimp Ring PEX</p> <p>1/2" Cold Exp. PEX</p>	<p>6</p> <p>6</p> <p>6</p>
<p>Four port valves can be used with either Tub/Shower or Shower Only applications. Three port valves can ONLY be used with Shower Only applications. For more product details, reference pages 465-466 in valve section.</p>					
<p>HOW TO ORDER VALVES: PAGES 465-466</p>		<p>  TRIM PART #   VALVE PART #   COMPLETE FAUCET </p>			





		MODEL	LIST	FINISH/CONNECT	CASE QTY
M-CORE® 2-SERIES VALVE ONLY TRIM					
	<ul style="list-style-type: none"> • red/blue markings: included • includes: pressure balanced cartridge with temperature control • valve: sold separately 	UTL181	153.30	Chrome	3
M-CORE® MIXING SHOWER VALVE					
	<ul style="list-style-type: none"> • tub/shower or shower only application • ports: four with adj. temp. limit stops • included: test plug and cross flow plug 	U140CI 71.20 U140X 71.20 U140CX 71.20 U140V 87.20	1/2" CC/IPS 1/2" Crimp Ring PEX + CC/IPS Tub 1/2" Cold Exp. PEX + CC/IPS Tub 1/2" CPVC + CC/IPS Tub	6 6 6 6	
	<ul style="list-style-type: none"> • tub/shower or shower only application • ports: four with adj. temp. limit stops • quarter turn stops: included 	U140CIS 102.45 U140XS 102.45 U140CXS 102.45 U140VS 118.50	1/2" CC/IPS 1/2" Crimp Ring PEX + CC/IPS Tub 1/2" Cold Exp. PEX + CC/IPS Tub 1/2" CPVC + CC/IPS Tub	6 6 6 6	
	<ul style="list-style-type: none"> • tub/shower only application • ports: four with adj. temp. limit stops • tub outlet: pre-fabricated 1/2" copper tube • included: quarter turn stops and plugs 	U140X-PF 80.40 U140CX-PF 80.40	1/2" Crimp Ring PEX 1/2" Cold Exp. PEX	6 6	
	<ul style="list-style-type: none"> • tub/shower only application • ports: four with adj. temp. limit stops • tub outlet: pre-fabricated 1/2" copper tube • included: quarter turn stops and plugs 	U140XS-PF 111.70 U140CXS-PF 111.70	1/2" Crimp Ring PEX 1/2" Cold Exp. PEX	6 6	
	<ul style="list-style-type: none"> • shower only application • ports: three 	U130CI 71.20 U130X 71.20 U130CX 71.20	1/2" CC/IPS 1/2" Crimp Ring PEX 1/2" Cold Exp. PEX	6 6 6	
	<ul style="list-style-type: none"> • shower only application • ports: three • quarter turn stops: included 	U130CIS 102.45 U130XS 102.45 U130CXS 102.45	1/2" CC/IPS 1/2" Crimp Ring PEX 1/2" Cold Exp. PEX	6 6 6	
Four port valves can be used with either Tub/Shower or Shower Only applications. Three port valves can ONLY be used with Shower Only applications. For more product details, reference pages 465-466 in valve section.					
HOW TO ORDER VALVES: PAGES 465-466	 TRIM PART #	+	 VALVE PART #	=	 COMPLETE FAUCET









		MODEL	LIST	FINISH/CONNECT	CASE QTY
POSI-TEMP® TUB/SHOWER					
	<ul style="list-style-type: none"> • ports: four • connection: 1/2" CC • showerhead: single-function standard • showerhead size: 2-1/2" diameter • tub spout length: 5 1/2" • tub spout connection type: slip fit • tub spout type: diverter • red/blue markings: included • adjustable temp limit stop: included 	2.5 GPM (9.5 L/min) max. 2353	225.35	Chrome	12
	<ul style="list-style-type: none"> • ports: four • connection: 1/2" CC • showerhead: single-function standard • showerhead size: 2-1/2" diameter • tub spout length: 5 1/2" • tub spout connection type: slip fit • tub spout type: diverter • red/blue markings: included • adjustable temp limit stop: included • quarter turn stops: included 	2.5 GPM (9.5 L/min) max. 2363	257.55	Chrome	12
	<ul style="list-style-type: none"> • ports: four • connection: 1/2" CC • showerhead: single-function standard • showerhead size: 2-1/2" diameter • tub spout length: 5 1/2" • tub spout connection type: slip fit • tub spout type: diverter • red/blue markings: included • adjustable temp limit stop: included <p> </p>	2.5 GPM (9.5 L/min) max. L2353	225.35	Chrome	6
	<ul style="list-style-type: none"> • ports: four • connection: 1/2" CC • showerhead: single-function standard • showerhead size: 2-1/2" diameter • tub spout length: 5 1/2" • tub spout connection type: slip fit • tub spout type: diverter • red/blue markings: included • adjustable temp limit stop: included • quarter turn stops: included <p> </p>	2.5 GPM (9.5 L/min) max. L2363	257.55	Chrome	6
	<ul style="list-style-type: none"> • ports: four • connection: 1/2" CC • showerhead: single-function eco-performance • showerhead size: 2-1/2" diameter • tub spout length: 5 1/2" • tub spout connection type: slip fit • tub spout type: diverter • adjustable temp limit stop: included • quarter turn stops: included <p> </p>	 1.75 GPM (6.65 L/min) max. L2369EP	307.70	Chrome	3

MODEL LIST FINISH/CONNECT CASE QTY



POSI-TEMP® TUB/SHOWER TRIM					
	<ul style="list-style-type: none"> • showerhead: single-function standard • showerhead size: 2-1/2" diameter • tub spout length: 5 1/2" 	2.5 GPM (9.5 L/min) max.			
	<ul style="list-style-type: none"> • tub spout connection type: slip fit • tub spout type: diverter • red/blue markings: included • valve: sold separately 	TL183◆	79.65	Chrome	12
	<ul style="list-style-type: none"> • showerhead: single-function eco-performance • showerhead size: 2-1/2" diameter • tub spout length: 5 1/2" 	1.75 GPM (6.65 L/min) max.			
	<ul style="list-style-type: none"> • tub spout connection type: slip fit • tub spout type: diverter • used to replace: 2 or 3 hole shower valve • valve: sold separately 	TL183EP◆	79.65	Chrome	12
	<ul style="list-style-type: none"> • showerhead: single-function eco-performance • showerhead size: 2-1/2" diameter • tub spout length: 5 1/2" 	1.75 GPM (6.65 L/min) max.			
	<ul style="list-style-type: none"> • tub spout connection type: slip fit • tub spout type: diverter • used to replace: 2 or 3 hole shower valve • valve: sold separately 	TL2369EP	125.75	Chrome	6
POSI-TEMP® SHOWER MIXING VALVES					
	<ul style="list-style-type: none"> • tub/shower or shower only application • ports: four with adjustable temp. limit stops • test plug: included 	2520◆	156.10	1/2" CC	6
	<ul style="list-style-type: none"> • test plug: included 	2510◆	156.10	1/2" IPS	6
	<ul style="list-style-type: none"> • tub/shower or shower only application • ports: four with adjustable temp. limit stops • quarter turn stops: included • test plug: included 	2570◆	189.55	1/2" CC	6
	<ul style="list-style-type: none"> • quarter turn stops: included • test plug: included 	2590◆	189.55	1/2" IPS	6
	<ul style="list-style-type: none"> • test plug: included 	2580◆	156.10	1/2" Crimp ring PEX	6
	<ul style="list-style-type: none"> • test plug: included 				
	<ul style="list-style-type: none"> • tub/shower only application • ports: four with adjustable temp. limit stops • quarter turn stops: included • test plug: included 	2360PF	208.45	1/2" Crimp Ring PEX	3
	<ul style="list-style-type: none"> • quarter turn stops: included • test plug: included 	2385PF	208.45	1/2" Cold Exp. PEX	3
	<ul style="list-style-type: none"> • shower only application • ports: three with adjustable temp. limit stops • quarter turn stops: included • test plug: included 	2326PF	201.20	1/2" Crimp Ring PEX	6
	<ul style="list-style-type: none"> • quarter turn stops: included • test plug: included 	2328PF	201.20	1/2" Cold Exp. PEX	6
<p>Four port valves can be used with either Tub/Shower or Shower Only applications. Three port valves can ONLY be used with Shower Only applications. For more product details, reference page 467-468 in valve section.</p>					
<p>HOW TO ORDER VALVES: PAGES 467-470</p>	 <p>TRIM PART #</p>	+	 <p>VALVE PART #</p>	=	 <p>COMPLETE FAUCET</p>

		MODEL	LIST	FINISH/CONNECT	CASE QTY
POSI-TEMP® SHOWER ONLY					
	<ul style="list-style-type: none"> • ports: four • connection: 1/2" CC • showerhead: single-function standard • showerhead size: 2-1/2" diameter • red/blue markings: included • adjustable temp limit stop: included 	2.5 GPM (9.5 L/min) max. L2352	197.30	Chrome	6
	<ul style="list-style-type: none"> • ports: four • connection: 1/2" CC • showerhead: single-function standard • showerhead size: 2-1/2" diameter • red/blue markings: included • adjustable temp limit stop: included • quarter turn stops: included 	2.5 GPM (9.5 L/min) max. L2362	229.30	Chrome	6
	<ul style="list-style-type: none"> • ports: four • connection: 1/2" CC • showerhead: single-function eco-performance • showerhead size: 2-1/2" diameter • red/blue markings: included • adjustable temp limit stop: included • quarter turn stops: included • used to replace: 2 or 3 hole shower valve 	 1.75 GPM (6.65 L/min) max. L2368EP	285.20	Chrome	3
HOW TO ORDER VALVES: PAGE 467	 TRIM PART #	+	 VALVE PART #	=	 COMPLETE FAUCET

















POSI-TEMP® SHOWER ONLY TRIM					
	<ul style="list-style-type: none"> • showerhead: single-function standard • showerhead size: 2-1/2" diameter • red/blue markings: included • valve: sold separately 	2.5 GPM (9.5 L/min) max. TL182◆	49.05	Chrome	12
	<ul style="list-style-type: none"> • showerhead: single-function eco-performance • showerhead size: 2-1/2" diameter • used to replace: 2 or 3 hole shower valve • valve: sold separately 	 1.75 GPM (6.65 L/min) max. TL2368EP	103.40	Chrome	6













POSI-TEMP® SHOWER MIXING VALVES					
	<ul style="list-style-type: none"> • tub/shower or shower only application • ports: four with adjustable temp. limit stops • test plug: included 	2520 ◆	156.10	1/2" CC	6
		2510 ◆	156.10	1/2" IPS	6
	<ul style="list-style-type: none"> • tub/shower or shower only application • ports: four with adjustable temp. limit stops • quarter turn stops: included • test plug: included 	2570 ◆	189.55	1/2" CC	6
		2590 ◆	189.55	1/2" IPS	6
		2580 ◆	156.10	1/2" Crimp ring PEX	6
	<ul style="list-style-type: none"> • tub/shower only application • ports: four with adjustable temp. limit stops • quarter turn stops: included • test plug: included 	2360PF	208.45	1/2" Crimp Ring PEX	3
		2385PF	208.45	1/2" Cold Exp. PEX	3
	<ul style="list-style-type: none"> • shower only application • ports: three with adjustable temp. limit stops • quarter turn stops: included • test plug: included 	2326PF	201.20	1/2" Crimp Ring PEX	6
		2328PF	201.20	1/2" Cold Exp. PEX	6

Four port valves can be used with either Tub/Shower or Shower Only applications.
 Three port valves can ONLY be used with Shower Only applications. For more product details, reference page 467-468 in valve section.

HOW TO ORDER VALVES: PAGE 467	 TRIM PART #	+	 VALVE PART #	=	 COMPLETE FAUCET
---	--	----------	---	----------	--

CHATEAU®

		MODEL	LIST	FINISH/CONNECT	CASE QTY	
POSI-TEMP® VALVE ONLY						
	<ul style="list-style-type: none"> • ports: four • connection: 1/2" CC • red/blue markings: included • adjustable temp limit stop: included • quarter turn stops: included 	L2361	214.80	Chrome	6	
POSI-TEMP® VALVE ONLY TRIM						
	<ul style="list-style-type: none"> • red/blue markings: included • valve: sold separately 	T181◆	44.55	Chrome	12	
	<ul style="list-style-type: none"> • red/blue markings: included • valve: sold separately 	TL181◆	44.55	Chrome	12	
POSI-TEMP® SHOWER MIXING VALVES						
	<ul style="list-style-type: none"> • tub/shower or shower only application • ports: four with adjustable temp. limit stops • test plug: included 	2520◆	156.10	1/2" CC	6	
		2510◆	156.10	1/2" IPS	6	
	<ul style="list-style-type: none"> • tub/shower or shower only application • ports: four with adjustable temp. limit stops • quarter turn stops: included • test plug: included 	2570◆	189.55	1/2" CC	6	
		2590◆	189.55	1/2" IPS	6	
		2580◆	156.10	1/2" Crimp ring PEX	6	
	<ul style="list-style-type: none"> • tub/shower only application • ports: four with adjustable temp. limit stops • quarter turn stops: included • test plug: included 	2360PF	208.45	1/2" Crimp Ring PEX	3	
		2385PF	208.45	1/2" Cold Exp. PEX	3	
	<ul style="list-style-type: none"> • shower only application • ports: three with adjustable temp. limit stops • quarter turn stops: included • test plug: included 	2326PF	201.20	1/2" Crimp Ring PEX	6	
		2328PF	201.20	1/2" Cold Exp. PEX	6	
<p>Four port valves can be used with either Tub/Shower or Shower Only applications. Three port valves can ONLY be used with Shower Only applications. For more product details, reference page 467-468 in valve section.</p>						
HOW TO ORDER VALVES: PAGES 467-470		 TRIM PART #	+	 VALVE PART #	=	 COMPLETE FAUCET

		MODEL	LIST	FINISH/CONNECT	CASE QTY
THREE-HANDLE NON-PRESSURE BALANCED TUB/SHOWER					
	<ul style="list-style-type: none"> • ports: four • connection: 1/2" CC; IPS • showerhead: single-function eco-performance • showerhead size: 2-1/2" diameter • tub spout length: 5 1/2" • tub spout connection type: IPS • tub spout type: non diverter 	 1.75 GPM (6.65 L/min) max.			
		2995EP	258.70	Chrome	6
					
TWO-HANDLE NON-PRESSURE BALANCED TUB/SHOWER					
	<ul style="list-style-type: none"> • ports: four • connection: 1/2" CC • showerhead: single-function eco-performance • showerhead size: 2-1/2" diameter • tub spout length: 5 1/2" • tub spout connection type: slip fit • tub spout type: diverter 	 1.75 GPM (6.65 L/min) max.			
		2919EP	221.20	Chrome	6
					
	<ul style="list-style-type: none"> • ports: four • connection: 1/2" IPS • showerhead: single-function eco-performance • showerhead size: 2-1/2" diameter • tub spout length: 5 1/2" • tub spout connection: 1/2" IPS • tub spout type: diverter 	 1.75 GPM (6.65 L/min) max.			
		2982EP	221.20	Chrome	6
					

Moen® bath accessories CANNOT be combined with Moen faucet parts on a Purchase Order.

COORDINATING ACCESSORIES

Perfectly suited styles for a cohesive look. From robe hooks to towel bars, paper holders to knobs and pulls, Moen offers a variety of coordinating accessories to complete any room.

MODEL NUMBER	LIST EACH	DESCRIPTION	QTY
Chrome (CH)			
YB8000CH	6.00	Mounting Posts (Pair)	50
YB8003CH	5.25	Double Robe Hook	50
YB8086CH	9.90	Towel Ring	50
YB8088CH	10.85	Double Paper Holder	25
YB8094CH	5.00	24" Towel Bar (Bar Only)	50
YB8098CH	4.30	18" Towel Bar (Bar Only)	50
YB8099CH	2.10	Paper Holder (Roller Only)	50
Brushed Chrome (BC)			
YB8000BC	7.65	Mounting Posts (Pair)	50
YB8003BC	6.70	Double Robe Hook	50
YB8086BC	13.05	Towel Ring	50
YB8094BC	6.45	24" Towel Bar (Bar Only)	50
YB8098BC	5.45	18" Towel Bar (Bar Only)	50
YB8099BC	3.55	Paper Holder (Roller Only)	50
Satin Nickel (SN)			
YB8000SN	9.90	Mounting Posts (Pair)	50
YB8003SN	6.85	Double Robe Hook	50
YB8086SN	14.15	Towel Ring	50
YB8088SN	17.70	Double Paper Holder	25
YB8094SN	8.20	24" Towel Bar (Bar Only)	50
YB8098SN	6.60	18" Towel Bar (Bar Only)	50
YB8099SN	3.20	Paper Holder (Roller Only)	50
Old World Bronze (OWB)			
YB8000OWB	12.85	Mounting Posts (Pair)	50
YB8003OWB	7.85	Double Robe Hook	50
YB8086OWB	15.15	Towel Ring	50
YB8094OWB	10.15	24" Towel Bar (Bar Only)	50
YB8098OWB	7.65	18" Towel Bar (Bar Only)	50
YB8099OWB	2.70	Paper Holder (Roller Only)	50
Pro-Fit® Installation Mounting Template			
YB8081	14.90	Pro-Fit® Installation Mounting Template	25



Double Robe Hook
YB8003



Towel Ring
YB8086



Paper Holder
YB8099 | Roller Only



Double Paper Holder
YB8088
(Roller not included)

Mounting Posts (Pair)
YB8000



18" Towel Bar
YB8098 | Bar Only



YB8081
Pro-Fit® Installation Mounting Template
(See page 480 for more information about the Pro-Fit® Installation System.)

24" Towel Bar
YB8094 | Bar Only

Mounting Posts (Pair)
YB8000



List price is per each (unless otherwise noted).
 Product can be ordered by case quantity or individually.
 For more information on ordering bath accessories, contact Moen Bath Accessory Customer Service at 800-882-0116, contact your local Moen sales representative, or visit us at www.moen.com.

CUSTOM SHOWERING





COMPLETELY CUSTOMIZED BLISS

The Verso™ Rainshower featuring Infiniti™ Dial with Magnetix® offers endless spray pressure and coverage options for limitless luxury in the shower. It's just one of Moen's many customizable shower options that helps you create the experience you desire, every day.

Verso Rainshower Featuring Infiniti Dial in Brushed Nickel | 220R3BN



COMPLETELY CUSTOMIZED BLISS

The Verso® Rainshower featuring Infiniti™ Dial with Magnetix® offers endless spray pressure and coverage options for limitless luxury in the shower. It's just one of Moen's many customizable shower options that helps you create the experience you desire, every day.

Verso Rainshower Featuring Infiniti Dial in Brushed Nickel | 220R3BN

Custom Showering

Spa and Custom Showering options

FINISHES

Chrome
Brushed Nickel
Brushed Gold
Polished Nickel
Oil Rubbed Bronze
Matte Black
Matte Black/Chrome
Wrought Iron/Matte Black
Brushed Chrome

LifeShine® Non-Tarnish Finish

All Brushed Nickel, Brushed Gold and Polished Nickel faucet components feature the LifeShine Non-Tarnish Finish.

Wrought Iron/Matte Black

Wrought Iron and Matte Black are the same finish and interchangeable.

ICON KEY

MAGNETIX

Magnetic docking system. Showerhead detaches effortlessly, then returns with a telltale snap that lets you know it's securely docked.



WaterSense Labeled

Product has been tested and is certified to meet EPA flow control criteria.



IMMERSION

Immersion™ Rainshower

Immersion Rainshower's innovative technology provides optimal water pressure and excellent coverage for an unparalleled shower experience.



Moen® M•PACT® Common Valve System

With M•PACT, you can change your faucet style without replacing any plumbing. It's as easy as changing a light bulb.

DURALOCK®

Push-button connector that makes installing faucets quick, secure and hassle-free – no tools required. A telltale 'click' audibly signals a secure connection.

DURALAST®

Provides the smooth feel and reliable operation of a new faucet from the first time you use it to the last.



Also available in bulk pack.
See page 589.



Available in bulk pack only.



Smart Shower Options



Moen has all the components necessary for you to build a custom shower spa. And, we're making it easy for you to pull together the different items you need. Charts of common shower spa configurations are included so that all the components can be ordered. The charts below each illustrate one potential layout with option of showering components. Refer to pages 429 - 460 in the Custom Showering section to choose from our wide array of showering products, styles and finishes to meet your preference. For additional assistance, call your Moen Sales Representative.



MOEN SMART SHOWER SPA WITH SHOWERHEAD, HANDSHOWER & FLUSHMOUNT BODY SPRAYS



Smart Shower four-outlet system

Moen Smart Shower four-outlet controller	Moen Smart Shower four-outlet valve	Rainshower	Shower arm & flange	Multi-function body spray* & quantity	Body spray rough-in & quantity	Four-function handheld shower with slide bar	Drop ell
TS3304TB or TB3304BL	S3104	S6310	S122	TS1422 x 4	S1300 x 4	3667EP	A725

* Option: Round single function body spray TS1322

Optional	Product
Battery backup (black)	179573

MOEN SMART SHOWER SPA WITH SHOWERHEAD, HANDSHOWER & EXPOSED BODY SPRAYS



Smart Shower four-outlet system

Moen Smart Shower four-outlet controller	Moen Smart Shower four-outlet valve	Rainshower	Shower arm & flange	Single function body spray & quantity	Four-function handheld shower with slide bar	Drop ell
TS3304TB or TB3304BL	S3104	S6310	S122	A501 x 4	3667EP	A725

Optional	Product
Battery backup (black)	179573

Smart Shower Configurations

CUSTOM SHOWERING

MOEN SMART SHOWER SHOWER SPA WITH SHOWERHEAD & FLUSHMOUNT BODY SPRAYS



Smart Shower two-outlet system.

Moen Smart Shower two outlet controller	Moen Smart Shower two outlet valve	Rainshower	Shower arm & flange	Multi-function body spray* & quantity	Body spray rough-in & quantity
TS3302TB or TB3302BL	S3102	S6310	S122	TS1422 x 3	S1300x 3

* Option: Round single function body spray TS1322

Optional	Product
Battery backup (black)	179573

MOEN SMART SHOWER SHOWER SPA WITH SHOWERHEAD & HANDSHOWER







Smart Shower two-outlet system.

Moen Smart Shower two-outlet controller	Moen Smart Shower two-outlet valve	Rainshower	Shower arm & flange	Handshower	Drop ell
TS3302TB or TB3302BL	S3102	S6310	S122	3667EP	A725





Valve	Flow Rate @ 20 PSI	Flow Rate @ 40 PSI	Flow Rate @ 60 PSI	Used with 2- or 3-Function Transfer	Maximum Components
Moen Smart Shower S3104	9.0	13.0	16.0	No	4 Components: Any combination of Showerheads, Handshowers and Body Sprays (4 Max)
Moen Smart Shower S3102	6.0	8.5	10.0	No	Showerhead, Handshower or Showerhead, 2 Body Sprays

Smart Shower Configurations

CUSTOM SHOWERING

SMART SHOWER	4 OUTLET THERMOSTATIC CONTROLLER - PREMIUM				
 <ul style="list-style-type: none"> • description: wifi connected, app driven shower controller • features: precise temperature control • Moen Smart Shower: compatible with Amazon Alexa, Apple Homekit/Siri and Google Assistant • showerhead type: showerhead sold separately • smart phone app: available for Apple IOS and Android OS • features: remote activation via smart phone app • features: warm-up and pause mode • features: optional shower timer • presets: two on controller, 12 in total with smart phone app • valve sold separately 		TS3304TB	842.45	Terra Beige	3
		TS3304BL	842.45	Matte Black	3
		  			

SMART SHOWER	4 OUTLET VALVE - PREMIUM				
 <ul style="list-style-type: none"> • description: digital thermostatic shower valve • ports: four outlets • features: precise temperature control • connection size: 3/4" inlets & 1/2" outlets • includes: 30 foot data cable • battery backup: sold separately 		S3104	1800.30	3/4" CC	3
				BATTERY BACKUP SOLD SEPARATELY	
		179573	76.75	N/A	6

SMART SHOWER	2 OUTLET THERMOSTATIC CONTROLLER - PREMIUM				
 <ul style="list-style-type: none"> • description: wifi connected, app driven shower controller • features: precise temperature control • Moen Smart Shower: compatible with Amazon Alexa, Apple Homekit/Siri and Google Assistant • showerhead type: showerhead sold separately • smart phone app: available for Apple IOS and Android OS • features: remote activation via smart phone app • features: warm-up and pause mode • features: optional shower timer • presets: two on controller, 12 in total with smart phone app • valve sold separately 		TS3302TB	553.95	Terra Beige	3
		TS3302BL	553.95	Matte Black	3
		  			

SMART SHOWER	2 OUTLET VALVE - PREMIUM				
 <ul style="list-style-type: none"> • description: digital thermostatic shower valve • ports: two outlets • features: precise temperature control • connection size: 1/2" inlets & 1/2" outlets • includes: 30 foot data cable • battery backup: sold separately 		S3102	842.45	1/2" CC	3
				BATTERY BACKUP SOLD SEPARATELY	
		179573	76.75	N/A	6

3/4" THERMOSTATIC SHOWERING

ExactTemp® 3/4" Thermostatic Valve and Showering

Moen has all the components necessary for you to build a custom shower spa. And, we're making it easy for you to pull together the sku numbers you need. Charts of common shower spa configurations are included so that all the components can be ordered. The charts below illustrate one layout and option of showering components. Refer to pages 429 - 460 in the Custom Showering section to choose from our wide array of showering products, styles and finishes to meet your preference. For additional assistance, call your Moen Sales Representative.



EXACTTEMP® SHOWER SPA WITH SHOWERHEAD, HANDSHOWER & FLUSHMOUNT BODY SPRAYS



Weymouth® suite shown.

Suite	ExactTemp Valve Only Trim	ExactTemp Valve	Volume Control Trim and Quantity	Volume Control Valve and Quantity	Showerhead	Shower Arm and Flange	Multi-Function Body Spray* and Quantity	Body Spray Rough-in and Quantity	Handheld Shower with Slide Bar	Drop Ell
Weymouth®	TS32110	S3371	TS52104 x 3	S3600 x 3	S1311	S113	TS1422 x 4	S1300 x 4	S12107EP	A725
Arris®	TS33002	S3371	TS33003 x 3	S3600 x 3	S112	S110	TS1422 x 4	S1300 x 4	3887EP	A725
Flara™	TS4201	S3371	TS4202 x 3	S3600 x 3	S6365	123815 137488	TS1422 x 4	S1300 x 4	S3880EP	A725
Colinet™	TS44401	S3371	TS44402 x 3	S3600 x 3	A112	151380 AT2199	TS1422 x 4	S1300 x 4	3887EP	A725
90°®	TS3100	S3371	TS3300 x 3	S3600 x 3	S6340	S122	TS1420 x 4	S1300 x 4	S3880EP	A721
Doux™	TS3101	S3371	TS3102 x 3	S3600 x 3	S176	S122	TS1422 x 4	S1300 x 4	3887EP	A725
Greenfield™	T4401	S3371	T4402 x 3	S3600 x 3	S178	S134	TS1422 x 4	S1300 x 4	3887EP	A725
Wynford®	T6601	S3371	T6602 x 3	S3600 x 3	S6310	S122	TS1422 x 4	S1300 x 4	3667EP	A725
Align®	T4291	S3371	T4292 x 3	S3600 x 3	S176	S122	TS1422 x 4	S1300 x 4	3887EP	A725
Belfield™	T4411	S3371	T4412 x 3	S3600 x 3	S6310	S122	TS1422 x 4	S1300 x 4	3667EP	A725
Cia™	T4621	S3371	T4622 x 3	S3600 x 3	S112	S122	TS1422 x 4	S1300 x 4	3887EP	A725
Voss™	T4691	S3371	T4692 x 3	S3600 x 3	S6365	161951	TS1420 x 4	S1300 x 4	3988EP	A721
Moen	TS3411	S3371	TS3600 x 3	S3600 x 3	S6310	S122	TS1422 x 4	S1300 x 4	3667EP	A725

* Option: Round single function body spray TS1322

* Option: Square single function body spray TS1320

Diverter tub spout options on pages 453-455.

Showering extension kits available on page 547.

Matching tub and shower drains available. See page 460.

Valve	Flow Rate through shower port (GPM) @ 20 PSI	Flow Rate through shower port (GPM) @ 40 PSI	Flow Rate through shower port (GPM) @ 60 PSI	Used with 2- or 3-Function Transfer	Maximum Components
3/4" ExactTemp S3371	11.4	15.7	18.0	No	4 Components: Any combination of Showerheads, Handshowers and Body Sprays (4 Max)

ExactTemp® 3/4" Thermostatic Showering Configurations

EXACTTEMP® SHOWER SPA WITH SHOWERHEAD, HANDSHOWER & EXPOSED MOUNT BODY SPRAYS

Weymouth® suite shown.

Suite	ExactTemp Valve Only Trim	ExactTemp Valve	Volume Control Trim and Quantity	Volume Control Valve and Quantity	Showerhead	Shower Arm and Flange	Single Function Body Spray and Quantity	Handheld Shower with Slide Bar	Drop Ell
Weymouth®	TS32110	S3371	TS52104 x 3	S3600 x 3	S1311	S113	A501 x 4	S12107EP	A725
Arris®	TS33002	S3371	TS33003 x 3	S3600 x 3	S112	S110	A501 x 4	3887EP	A725
Flara™	TS4201	S3371	TS4202 x 3	S3600 x 3	S6365	123815 137488	A501 x 4	S3880EP	A725
Colinet™	TS44401	S3371	TS44402 x 3	S3600 x 3	A112	151380 AT2199	A501 x 4	3887EP	A725
90°®	TS3100	S3371	TS3300 x 3	S3600 x 3	S6340	S122	A501 x 4	S3880EP	A721
Doux™	TS3101	S3371	TS3102 x 3	S3600 x 3	S176	S122	A501 x 4	3887EP	A725
Greenfield™	T4401	S3371	T4402 x 3	S3600 x 3	S178	S134	A501 x 4	3887EP	A725
Wynford®	T6601	S3371	T6602 x 3	S3600 x 3	S6310	S122	A501 x 4	3667EP	A725
Align®	T4291	S3371	T4292 x 3	S3600 x 3	S176	S122	A501 x 4	3887EP	A725
Belfield™	T4411	S3371	T4412 x 3	S3600 x 3	S6310	S122	A501 x 4	3667EP	A725
Cia™	T4621	S3371	T4622 x 3	S3600 x 3	S112	S122	A501 x 4	3887EP	A725
Voss™	T4691	S3371	T4692 x 3	S3600 x 3	S6365	161951	A501 x 4	3988EP	A721
Moen	TS3411	S3371	TS3600 x 3	S3600 x 3	S6310	S122	A501 x 4	3667EP	A725

Diverter tub spout options on pages 453-455.

Showering extension kits available on page 547.

Matching tub and shower drains available. See page 460.

Valve	Flow Rate through shower port (GPM) @ 20 PSI	Flow Rate through shower port (GPM) @ 40 PSI	Flow Rate through shower port (GPM) @ 60 PSI	Used with 2- or 3-Function Transfer	Maximum Components
3/4" ExactTemp S3371	11.4	15.7	18.0	No	4 Components: Any combination of Showerheads, Handshowers and Body Sprays (4 Max)

ExactTemp® 3/4" Thermostatic Showering Configurations

CUSTOM SHOWERING

EXACTTEMP® SHOWER SPA WITH SHOWERHEAD & HANDSHOWER













Flara™ suite shown.

Suite	ExactTemp Valve Only Trim	ExactTemp Valve	Volume Control Trim and Quantity	Volume Control Valve and Quantity	Showerhead	Shower Arm and Flange	Handheld Shower with Slide Bar	Drop Ell
Weymouth®	TS32110	S3371	TS52104 x 2	S3600 x 2	S1311	S113	S12107EP	A725
Arris®	TS33002	S3371	TS33003 x 2	S3600 x 2	S112	S110	3887EP	A725
Flara™	TS4201	S3371	TS4202 x 2	S3600 x 2	S6365	123815 137488	S3880EP	A725
Colinet™	TS44401	S3371	TS44402 x 2	S3600 x 2	S112	151380 AT2199	3887EP	A725
90°®	TS3100	S3371	TS3300 x 2	S3600 x 2	S6340	S122	S3880EP	A721
Doux™	TS3101	S3371	TS3102 x 2	S3600 x 2	S176	S122	3887EP	A725
Greenfield™	T4401	S3371	T4402 x 2	S3600 x 2	S178	S134	3887EP	A725
Wynford®	T6601	S3371	T6602 x 2	S3600 x 2	S6310	S122	3667EP	A725
Align®	T4291	S3371	T4292 x 2	S3600 x 2	S176	S122	3887EP	A725
Belfield™	T4411	S3371	T4412 x 2	S3600 x 2	S6310	S122	3667EP	A725
Cia™	T4621	S3371	T4622 x 2	S3600 x 2	S112	S122	3887EP	A725
Voss™	T4691	S3371	T4692 x 2	S3600 x 2	S6365	161951	3988EP	A721
Moen	TS3411	S3371	TS3600 x 2	S3600 x 2	S6310	S122	3667EP	A725



















Diverter tub spout options on pages 453-455.
 Showering extension kits available on page 547.
 Matching tub and shower drains available. See page 460.

Valve	Flow Rate through shower port (GPM) @ 20 PSI	Flow Rate through shower port (GPM) @ 40 PSI	Flow Rate through shower port (GPM) @ 60 PSI	Used with 2- or 3-Function Transfer	Maximum Components
3/4" ExactTemp S3371	11.4	15.7	18.0	No	4 Components: Any combination of Showerheads, Handshowers and Body Sprays (4 Max)































ExactTemp® 3/4" Thermostatic Showering Options

		MODEL	LIST	FINISH/CONNECT	CASE QTY
	MOEN® EXACTTEMP® SHOWER ONLY TRIM - PREMIUM				
	<ul style="list-style-type: none"> • showerhead: single-function rainshower • showerhead size: 7" diameter • requires: separate volume control valve • valve: sold separately 	2.5 GPM (9.5 L/min) max.			
		TS3400	650.45	Chrome	3
		TS3400BN	1105.30	Brushed Nickel	3
		TS3400ORB	1160.40	Oil Rubbed Bronze	3
					
	WEYMOUTH® EXACTTEMP® VALVE ONLY TRIM - PREMIUM				
	<ul style="list-style-type: none"> • description: temperature control valve trim • requires: separate volume control valve • valve: sold separately 	TS32110	486.25	Chrome	3
		TS32110BN	715.70	Brushed Nickel	3
		TS32110NL	715.70	Polished Nickel	3
		TS32110BG	715.70	Brushed Gold	3
		TS32110BL	772.05	Matte Black	3
	TS32110ORB	772.05	Oil Rubbed Bronze	3	
	WEYMOUTH® EXACTTEMP® VOLUME CONTROL VALVE TRIM - PREMIUM				
	<ul style="list-style-type: none"> • valve: sold separately 	TS52104	252.45	Chrome	6
		TS52104BN	348.75	Brushed Nickel	6
		TS52104NL	348.75	Polished Nickel	6
		TS52104BG	348.75	Brushed Gold	6
		TS52104BL	376.05	Matte Black	6
	TS52104ORB	376.05	Oil Rubbed Bronze	6	
	ARRIS® EXACTTEMP® VALVE ONLY TRIM - PREMIUM				
	<ul style="list-style-type: none"> • description: temperature control valve trim • requires: separate volume control valve • valve: sold separately 	TS33002	399.80	Chrome	3
		TS33002BL	659.80	Matte Black	3
	ARRIS® EXACTTEMP® VOLUME CONTROL VALVE TRIM - PREMIUM				
	<ul style="list-style-type: none"> • valve: sold separately 	TS33003	228.40	Chrome	6
		TS33003BL	366.60	Matte Black	6
	FLARA™ EXACTTEMP® VALVE ONLY TRIM - PREMIUM				
	<ul style="list-style-type: none"> • description: temperature control valve trim • requires: separate volume control valve • valve: sold separately 	TS4201	402.00	Chrome	3
		TS4201BN	603.00	Brushed Nickel	3
		TS4201NL	603.00	Polished Nickel	3
	TS4201BG	603.00	Brushed Gold	3	
	FLARA™ EXACTTEMP® VOLUME CONTROL VALVE TRIM - PREMIUM				
	<ul style="list-style-type: none"> • valve: sold separately 	TS4202	185.50	Chrome	6
		TS4202BN	278.40	Brushed Nickel	6
		TS4202NL	278.40	Polished Nickel	6
	TS4202BG	278.40	Brushed Gold	6	
	COLINET™ EXACTTEMP® VALVE ONLY TRIM - PREMIUM				
	<ul style="list-style-type: none"> • description: temperature control valve trim • requires: separate volume control valve • valve: sold separately 	TS44401	384.50	Chrome	3
		TS44401BN	576.70	Brushed Nickel	3
		TS44401BG	576.70	Brushed Gold	3
	TS44401BL	634.45	Matte Black	3	
	COLINET™ EXACTTEMP® VOLUME CONTROL VALVE TRIM - PREMIUM				
	<ul style="list-style-type: none"> • valve: sold separately 	TS44402	177.50	Chrome	6
		TS44402BN	266.30	Brushed Nickel	6
		TS44402BG	266.30	Brushed Gold	6
	TS44402BL	292.90	Matte Black	6	

ExactTemp® 3/4" Thermostatic Showering Options

		MODEL	LIST	FINISH/CONNECT	CASE QTY
	EXACTTEMP® VALVE ONLY TRIM - PREMIUM <ul style="list-style-type: none"> • description: temperature control valve trim • requires: separate volume control valve • valve: sold separately 	TS3100	398.25	Chrome	3
		TS3100BN	602.40	Brushed Nickel	3
		Q3 NEW! TS3100BL	617.25	Matte Black	3
					
	EXACTTEMP® VOLUME CONTROL VALVE TRIM - PREMIUM <ul style="list-style-type: none"> • valve: sold separately 	TS3300	183.85	Chrome	6
		TS3300BN	245.15	Brushed Nickel	6
		Q3 NEW! TS3300BL	248.15	Matte Black	6
					
	EXACTTEMP® VALVE ONLY TRIM - PREMIUM <ul style="list-style-type: none"> • description: temperature control valve trim • requires: separate volume control valve • valve: sold separately 	TS3101	421.45	Chrome	3
		TS3101BN	611.05	Brushed Nickel	3
		TS3101BL	672.15	Matte Black	3
					
	EXACTTEMP® VOLUME CONTROL VALVE TRIM - PREMIUM <ul style="list-style-type: none"> • valve: sold separately 	TS3102	194.50	Chrome	6
		TS3102BN	282.10	Brushed Nickel	6
		TS3102BL	310.25	Matte Black	6
					
	EXACTTEMP® VALVE ONLY TRIM <ul style="list-style-type: none"> • description: temperature control valve trim • requires: separate volume control valve • valve: sold separately 	NEW! Q3 T4401	303.55	Chrome	3
		T4401BN	458.40	Brushed Nickel	3
		T4401BG	458.40	Brushed Gold	3
		T4401BL	493.25	Matte Black	3
					
	EXACTTEMP® VOLUME CONTROL VALVE TRIM <ul style="list-style-type: none"> • valve: sold separately 	NEW! Q3 T4402	154.50	Chrome	6
		T4402BN	232.90	Brushed Nickel	6
		T4402BG	232.90	Brushed Gold	6
		T4402BL	251.15	Matte Black	6
					
	EXACTTEMP® VALVE ONLY TRIM <ul style="list-style-type: none"> • description: temperature control valve trim • requires: separate volume control valve • valve: sold separately 	T6601	304.30	Chrome	3
		T6601BN	458.40	Brushed Nickel	3
		T6601ORB	494.50	Oil Rubbed Bronze	3
					
	EXACTTEMP® VOLUME CONTROL VALVE TRIM <ul style="list-style-type: none"> • valve: sold separately 	T6602	154.50	Chrome	6
		T6602BN	232.90	Brushed Nickel	6
		T6602ORB	251.15	Oil Rubbed Bronze	6
					
	EXACTTEMP® VALVE ONLY TRIM <ul style="list-style-type: none"> • description: temperature control valve trim • requires: separate volume control valve • valve: sold separately 	T4291	303.55	Chrome	3
		T4291BN	458.40	Brushed Nickel	3
		T4291BG	458.40	Brushed Gold	3
		T4291BL	493.25	Matte Black	3
					

ExactTemp® 3/4" Thermostatic Showering Options

		MODEL	LIST	FINISH/CONNECT	CASE QTY
	EXACTTEMP® VOLUME CONTROL VALVE TRIM • valve: sold separately  	T4292	154.50	Chrome	6
		T4292BN	232.90	Brushed Nickel	6
		T4292BG	232.90	Brushed Gold	6
		T4292BL	251.15	Matte Black	6
	EXACTTEMP® VALVE ONLY TRIM • description: temperature control valve trim • requires: separate volume control valve • valve: sold separately  	T4411	304.30	Chrome	3
		T4411BN	458.40	Brushed Nickel	3
		T4411NL	458.40	Polished Nickel	3
		Q3  T4411BL	471.65	Matte Black	3
		T4411ORB	494.50	Oil Rubbed Bronze	3
	EXACTTEMP® VOLUME CONTROL VALVE TRIM • valve: sold separately  	T4412	154.50	Chrome	6
		T4412BN	232.90	Brushed Nickel	6
		T4412NL	232.90	Polished Nickel	6
		Q3  T4412BL	239.45	Matte Black	6
		T4412ORB	251.15	Oil Rubbed Bronze	6
	EXACTTEMP® VALVE ONLY TRIM • description: temperature control valve trim • requires: separate volume control valve • valve: sold separately  	T4621	291.25	Chrome	3
		T4621BN	439.95	Brushed Nickel	3
		T4621BG	439.95	Brushed Gold	3
		T4621BL	473.40	Matte Black	3
	EXACTTEMP® VOLUME CONTROL VALVE TRIM • valve: sold separately  	T4622	148.30	Chrome	6
		T4622BN	223.50	Brushed Nickel	6
		T4622BG	223.50	Brushed Gold	6
		T4622BL	241.00	Matte Black	6
	EXACTTEMP® VALVE ONLY TRIM • description: temperature control valve trim • requires: separate volume control valve • valve: sold separately  	T4691	292.10	Chrome	3
		T4691BN	439.95	Brushed Nickel	3
		T4691NL	439.95	Polished Nickel	3
		T4691BG	439.95	Brushed Gold	3
		Q3  T4691BL	452.70	Matte Black	3
		T4691ORB	474.55	Oil Rubbed Bronze	3
	EXACTTEMP® VOLUME CONTROL VALVE TRIM • valve: sold separately  	T4692	148.30	Chrome	6
		T4692BN	223.50	Brushed Nickel	6
		T4692NL	223.50	Polished Nickel	6
		T4692BG	223.50	Brushed Gold	6
		Q3  T4692BL	229.85	Matte Black	6
		T4692ORB	241.00	Oil Rubbed Bronze	6
	EXACTTEMP® VALVE ONLY TRIM - PREMIUM • description: temperature control valve trim • requires: separate volume control valve • valve: sold separately  	TS3411	312.85	Chrome	3
		TS3411BN	491.45	Brushed Nickel	3
		TS3411ORB	516.20	Oil Rubbed Bronze	3
	EXACTTEMP® VOLUME CONTROL VALVE TRIM - PREMIUM • valve: sold separately  	TS3600	161.55	Chrome	6
		TS3600BN	287.40	Brushed Nickel	6
		TS3600ORB	301.95	Oil Rubbed Bronze	6

M-CORE® 3-Series With Integrated Transfer Valve Shower Spa Options

Moen has all the components necessary for you to build a custom shower spa. And, we're making it easy for you to pull together the sku numbers you need. Charts of common shower spa configurations are included so that all the components can be ordered. The charts below illustrate one layout and option of showering components. Refer to pages 429 - 460 in the Custom Showering section to choose from our wide array of showering products, styles and finishes to meet your preference. For additional assistance, call your Moen Sales Representative.



M-CORE® 3-SERIES SHOWERHEAD, BODY SPRAYS & HANDSHOWER



3 Showering Devices:
(3 Independent Functions or
3 Independent and 3 Shared Functions)
as determined by valve selection
Doux™ suite shown.

Suite	M-CORE 3-Series with Integrated Transfer Valve Trim	Showerhead	Shower Arm and Flange	Multi-Function Body Spray and Quantity	Multi-Function Body Spray Rough-In and Quantity	Handheld Shower with Slide Bar	Drop Ell
Weymouth®	UTS4311	S1311	S113	TS1422 x 2	S1300 x 2	S12107EP	A725
Arris®	UTS3311	S112	S110	TS1422 x 2	S1300 x 2	3887EP	A725
Flara™	UTS2411	S6365	123815 137488	TS1422 x 2	S1300 x 2	S3880EP	A725
Colinet™	UTS9211	S112	151380 AT2199	TS1422 x 2	S1300 x 2	3887EP	A725
90°®	UTS9011	S6340	123815 147572	TS1422 x 2	S1300 x 2	S3880EP	A721
Doux™	UTS2611	S176	123815 137488	TS1422 x 2	S1300 x 2	3887EP	A725
Greenfield™	UT33341	S178	123815 137488	TS1422 x 2	S1300 x 2	3887EP	A725
Wynford®	UT5500	S6310	123815 AT2199	TS1422 x 2	S1300 x 2	3667EP	A725
Align®	UT3290	S176	123815 137488	TS1422 x 2	S1300 x 2	3887EP	A725
Belfield™	UT3322	S6310	123815 AT2199	TS1422 x 2	S1300 x 2	3667EP	A725
Cia™	UT3331	S112	123815 137488	TS1422 x 2	S1300 x 2	3887EP	A725
Voss™	UT3611	S6365	123815 AT2199	TS1422 x 2	S1300 x 2	3988EP	A721

Use M-CORE U362 or U232 valves
Reference valve section for details

Diverter tub spout options on pages 453-455.
Matching tub and shower drains available. See page 460.

Valve	Flow Rate through shower port (GPM) @ 20 PSI	Flow Rate through shower port (GPM) @ 40 PSI	Flow Rate through shower port (GPM) @ 60 PSI
M-CORE 3 Function 6 Function (U362) or M-CORE 2 Function 3 Function (U232)	3.0	4.5	5.6

M-CORE transfer valve flow is the total flow when used in the shared mode.
When plumbing the U362 valve to flow three shared showering devices, 50 psi or higher is recommended for optimum performance.

M-CORE® 3-Series Multi-Function Showering Configurations

M-CORE® 3-SERIES CEILING SHOWERHEAD, SHOWERHEAD & HANDSHOWER



3 Showering Devices:
 (3 Independent Functions or
 3 Independent and 3 Shared Functions)
 as determined by valve selection
 Doux™ suite shown.

Suite	M-CORE 3-Series with Integrated Transfer Valve Trim	Ceiling Mount Showerhead	Ceiling Mount Shower Arm	Ceiling Mount Shower Arm Flange	Showerhead	Shower Arm	Shower Arm Flange	Handheld Shower with Slide Bar	Drop Ell
Weymouth®	UTS4311	S1311	226651	AT2199	S1311	S113		S12107EP	A725
Arris®	UTS3311	S112	226651	137488	S112	S110		3887EP	A725
Flara™	UTS2411	S6365	226651	137488	S6365	123815	137488	S3880EP	A725
Colinet™	UTS9211	S112	226651	AT2199	S112	151380	AT2199	3887EP	A725
90°®	UTS9011	S6340	226651	147572	S6340	123815	147572	S3880EP	A721
Doux™	UTS2611	S176	226651	137488	S176	123815	137488	3887EP	A725
Greenfield™	UT33341	S6360	226651	137488	S178	S134		3887EP	A725
Wynford®	UT5500	S6310	226651	AT2199	S6310	123815	AT2199	3667EP	A725
Align®	UT3290	S176	226651	137488	S176	123815	137488	3887EP	A725
Belfield™	UT3322	S6310	226651	AT2199	S6310	123815	AT2199	3667EP	A725
Cia™	UT3331	S112	226651	137488	S112	123815	137488	3887EP	A725
Voss™	UT3611	S6365	226651	AT2199	S6365	123815	AT2199	3988EP	A721

Use M-CORE U362 or U232 valves
 Reference valve section for details

Diverter tub spout options on pages 453-455.

Matching tub and shower drains available. See page 460.

Valve	Flow Rate through shower port (GPM) @ 20 PSI	Flow Rate through shower port (GPM) @ 40 PSI	Flow Rate through shower port (GPM) @ 60 PSI
M-CORE 3 Function 6 Function (U362) or M-CORE 2 Function 3 Function (U232)	3.0	4.5	5.6

M-CORE transfer valve flow is the total flow when used in the shared mode

M-CORE® 3-Series Multi-Function Showering Configurations

CUSTOM SHOWERING

M-CORE® 3-SERIES SHOWERHEAD & HANDSHOWER



2 Showering Devices:
 (2 Independent Functions or
 2 Independent and 1 Shared Function)
 as determined by valve selection
 Colinet™ suite shown.

Suite	M-CORE 3-Series with Integrated Transfer Valve Trim	Showerhead	Shower Arm	Shower Arm Flange	Handheld Shower with Slide Bar	Drop Ell
Weymouth®	UTS4311	S1311	S113		S12107EP	A725
Arris®	UTS3311	S112	S110		3887EP	A725
Flara™	UTS2411	S6365	123815	137488	S3880EP	A725
Colinet™	UTS9211	S112	151380	AT2199	3887EP	A725
90°®	UTS9011	S6340	123815	147572	S3880EP	A721
Doux™	UTS2611	S176	123815	137488	3887EP	A725
Greenfield™	UT33341	S178	S134		3887EP	A725
Wynford®	UT5500	S6310	123815	AT2199	3667EP	A725
Align®	UT3290	S176	123815	137488	3887EP	A725
Belfield™	UT3322	S6310	123815	AT2199	3667EP	A725
Cia™	UT3331	S112	123815	137488	3887EP	A725
Voss™	UT3611	S6365	123815	AT2199	3988EP	A721

Use with M-CORE U362 or U232 valves
 Reference valve section for details

Diverter tub spout options on pages 453-455.
 Matching tub and shower drains available. See page 460.

Valve	Flow Rate through shower port (GPM) @ 20 PSI	Flow Rate through shower port (GPM) @ 40 PSI	Flow Rate through shower port (GPM) @ 60 PSI
M-CORE 3 Function 6 Function (U362) or M-CORE 2 Function 3 Function (U232)	3.0	4.5	5.6

M-CORE transfer valve flow is the total flow when used in the shared mode

M-CORE® 3-Series Multi-Function Showering Configurations

M-CORE® 3-SERIES SHOWERHEAD & BODY SPRAYS



2 Showering Devices:
(2 Independent Functions or
2 Independent and 1 Shared Function)
as determined by valve selection
Colinet™ suite shown.

Suite	M-CORE 3-Series with Integrated Transfer Valve Trim	Showerhead	Shower Arm	Shower Arm Flange	Single Function Body Spray and Quantity	Body Spray Rough-in and Quantity
Weymouth®	UTS4311	S1311	S113		TS1322 x 2	S1300 x 2
Arris®	UTS3311	S112	S110		TS1322 x 2	S1300 x 2
Flara™	UTS2411	S6365	123815	137488	TS1322 x 2	S1300 x 2
Colinet™	UTS9211	S112	151380	AT2199	TS1322 x 2	S1300 x 2
90°®	UTS9011	S6340	123815	147572	TS1322 x 2	S1300 x 2
Doux™	UTS2611	S176	123815	137488	TS1322 x 2	S1300 x 2
Greenfield™	UT33341	S178	S134		TS1322 x 2	S1300 x 2
Wynford®	UT5500	S6310	123815	AT2199	TS1322 x 2	S1300 x 2
Align®	UT3290	S176	123815	137488	TS1322 x 2	S1300 x 2
Belfield™	UT3322	S6310	123815	AT2199	TS1322 x 2	S1300 x 2
Cia™	UT3331	S112	123815	137488	TS1322 x 2	S1300 x 2
Voss™	UT3611	S6365	123815	AT2199	TS1322 x 2	S1300 x 2

Use with M-CORE U362 or U232 valves
Reference valve section for details

Diverter tub spout options on pages 453-455.

Matching tub and shower drains available. See page 460.

Valve	Flow Rate through shower port (GPM) @ 20 PSI	Flow Rate through shower port (GPM) @ 40 PSI	Flow Rate through shower port (GPM) @ 60 PSI
M-CORE 3 Function 6 Function (U362) or M-CORE 2 Function 3 Function (U232)	3.0	4.5	5.6

M-CORE transfer valve flow is the total flow when used in the shared mode.

When plumbing the U362 valve to flow three shared showering devices, 50 psi or higher is recommended for optimum performance.

M-CORE® 3-Series Multi-Function Showering Configurations

CUSTOM SHOWERING

M-CORE® 3-SERIES SHOWERHEAD & NON-DIVERTING TUB SPOUT



2 Showering Devices:
 (2 Independent Functions using U232 valve set for Independent functionality)
 Colinet™ suite shown.

Suite	M-CORE 3-Series with Integrated Transfer Valve Trim	Showerhead	Shower Arm	Shower Arm Flange	Non-Diverting Tub Spout
Weymouth®	UTS4311	S1311	S113		S12105
Arris®	UTS3311	S112	S110		S16900
Flara™	UTS2411	S6365	123815	137488	S990
Colinet™	UTS9211	S112	151380	AT2199	S5001
90°®	UTS9011	S6340	123815	147572	S3898
Doux™	UTS2611	S176	123815	137488	S3869
Greenfield™	UT33341	S178	S134		4326
Wynford®	UT5500	S6310	123815	AT2199	19536
Align®	UT3290	S176	123815	137488	3892
Belfield™	UT3322	S6310	123815	AT2199	3858
Cia™	UT3331	S112	123815	137488	3347
Voss™	UT3611	S6365	123815	AT2199	191956

















Use with M-CORE U232 valves
 Reference valve section for details

Diverter tub spout options on pages 453-455.
 Matching tub and shower drains available. See page 460.





Valve	Flow Rate through shower port (GPM) @ 20 PSI	Flow Rate through shower port (GPM) @ 40 PSI	Flow Rate through shower port (GPM) @ 60 PSI
M-CORE 2 Function 3 Function (U232)	3.0	4.5	5.6

M-CORE transfer valve flow is the total flow when used in the shared mode

M-CORE® 3-Series Multi-Function Showering Options

		MODEL	LIST	FINISH/CONNECT	CASE QTY
WEYMOUTH®	M-CORE® 3-SERIES WITH INTEGRATED TRANSFER VALVE TRIM - PREMIUM				
	<ul style="list-style-type: none"> includes: pressure balanced cartridge with volume and temperature control valve: sold separately 	UTS4311	738.70	Chrome	4
		UTS4311BN	1071.10	Brushed Nickel	4
		UTS4311NL	1071.10	Polished Nickel	4
		UTS4311BG	1071.10	Brushed Gold	4
		UTS4311BL	1178.20	Matte Black	4
		UTS4311ORB	1178.20	Oil Rubbed Bronze	4
ARRIS®	M-CORE® 3-SERIES WITH INTEGRATED TRANSFER VALVE TRIM - PREMIUM				
	<ul style="list-style-type: none"> includes: pressure balanced cartridge with volume and temperature control valve: sold separately 	UTS3311	503.10	Chrome	4
		UTS3311BL	1094.95	Matte Black	4
FLARA™	M-CORE® 3-SERIES WITH INTEGRATED TRANSFER VALVE TRIM - PREMIUM				
	<ul style="list-style-type: none"> includes: pressure balanced cartridge with volume and temperature control valve: sold separately 	UTS2411	508.65	Chrome	4
		UTS2411BN	737.50	Brushed Nickel	4
		UTS2411NL	737.50	Polished Nickel	4
		UTS2411BG	737.50	Brushed Gold	4
COLINET™	M-CORE® 3-SERIES WITH INTEGRATED TRANSFER VALVE TRIM - PREMIUM				
	<ul style="list-style-type: none"> includes: pressure balanced cartridge with volume and temperature control valve: sold separately 	UTS9211	485.70	Chrome	4
		UTS9211BN	704.30	Brushed Nickel	4
		UTS9211BG	704.30	Brushed Gold	4
		UTS9211BL	774.70	Matte Black	4
90™	M-CORE® 3-SERIES WITH INTEGRATED TRANSFER VALVE TRIM - PREMIUM				
	<ul style="list-style-type: none"> includes: pressure balanced cartridge with volume and temperature control valve: sold separately 	UTS9011	420.40	Chrome	4
		UTS9011BN	608.70	Brushed Nickel	4
		Q3  UTS9011BL	630.60	Matte Black	4
DOUX™	M-CORE® 3-SERIES WITH INTEGRATED TRANSFER VALVE TRIM - PREMIUM				
	<ul style="list-style-type: none"> includes: pressure balanced cartridge with volume and temperature control valve: sold separately 	UTS2611	444.25	Chrome	4
		UTS2611BN	644.15	Brushed Nickel	4
		UTS2611BL	708.55	Matte Black	4
GREENFIELD™	M-CORE® 3-SERIES WITH INTEGRATED TRANSFER VALVE TRIM				
	<ul style="list-style-type: none"> includes: pressure balanced cartridge with volume and temperature control valve: sold separately 	NEW! Q3 UTS33341	328.90	Chrome	4
		UTS33341BN	407.75	Brushed Nickel	4
		UTS33341BG	407.75	Brushed Gold	4
		UTS33341BL	448.55	Matte Black	4
WYNFORD®	M-CORE® 3-SERIES WITH INTEGRATED TRANSFER VALVE TRIM				
	<ul style="list-style-type: none"> includes: pressure balanced cartridge with volume and temperature control valve: sold separately 	UT5500	320.90	Chrome	4
		UT5500BN	407.75	Brushed Nickel	4
		UT5500ORB	438.65	Oil Rubbed Bronze	4

M-CORE® 3-Series Multi-Function Showering Options

		MODEL	LIST	FINISH/CONNECT	CASE QTY
ALIGN®	M-CORE® 3-SERIES WITH INTEGRATED TRANSFER VALVE TRIM				
	<ul style="list-style-type: none"> • includes: pressure balanced cartridge with volume and temperature control • valve: sold separately 	UT3290	328.90	Chrome	4
		UT3290BN	407.75	Brushed Nickel	4
		UT3290BG	407.75	Brushed Gold	4
		UT3290BL	448.55	Matte Black	4
BELFIELD™	M-CORE® 3-SERIES WITH INTEGRATED TRANSFER VALVE TRIM				
	<ul style="list-style-type: none"> • includes: pressure balanced cartridge with volume and temperature control • valve: sold separately 	UT3322	328.90	Chrome	4
		UT3322BN	407.75	Brushed Nickel	4
		UT3322NL	407.75	Polished Nickel	4
		Q3 NEW! UT3322BL	427.55	Matte Black	4
		UT3322ORB	438.65	Oil Rubbed Bronze	4
CIA™	M-CORE® 3-SERIES WITH INTEGRATED TRANSFER VALVE TRIM				
	<ul style="list-style-type: none"> • includes: pressure balanced cartridge with volume and temperature control • valve: sold separately 	UT3331	315.65	Chrome	4
		UT3331BN	391.30	Brushed Nickel	4
		UT3331BG	391.30	Brushed Gold	4
		UT3331BL	430.45	Matte Black	4
VOSS™	M-CORE® 3-SERIES WITH INTEGRATED TRANSFER VALVE TRIM				
	<ul style="list-style-type: none"> • includes: pressure balanced cartridge with volume and temperature control • valve: sold separately 	UT3611	315.60	Chrome	4
		UT3611BN	391.30	Brushed Nickel	4
		UT3611NL	391.30	Polished Nickel	4
		UT3611BG	391.30	Brushed Gold	4
		Q3 NEW! UT3611BL	410.30	Matte Black	4
		UT3611ORB	420.95	Oil Rubbed Bronze	4

CUSTOM SHOWERING



See Custom Showering Product Icon Key, page 363.

◆ BULK PACK AVAILABLE

◆◆ BULK PACK ONLY

M-CORE® 4-SERIES, 3-SERIES AND 2-SERIES Transfer Valve Showering Configurations

Moen has all the components necessary for you to build a custom shower spa. And, we're making it easy for you to pull together the sku numbers you need. Charts of common shower spa configurations are included so that all the components can be ordered. The charts below illustrate one layout and option of showering components. Refer to pages 429 - 460 in the Custom Showering section to choose from our wide array of showering products, styles and finishes to meet your preference. For additional assistance, call your Moen Sales Representative.



M-CORE® 4-SERIES, 3-SERIES OR 2-SERIES: SHOWERHEAD, BODYSPRAYS & HANDSHOWER



3 Showering Devices:
(3 Independent Functions or
3 Independent and 3 Shared Functions)
as determined by valve selection
Arris® suite shown.

*mixing valve image shows M-CORE 3-Series trim

Suite	M-CORE Shower Only Trim PICK YOUR MIXING VALVE TRIM			M-CORE Transfer Valve Trim	Body Spray and Quantity	Handheld Shower with Slide Bar	Drop Ell
	4-Series	3-Series	2-Series				
Weymouth®	UTS43102EP	UTS33102	UTS232102EP	UTS32205	A501 x2	S12107EP	A725
Arris®	UTS42002EP	UTS32002	UTS22002EP	UTS23005	A501 x2	3887EP	A725
Flara™	UTS4912EP	UTS3912	UTS2912EP	UTS4911	A501 x2	S3880EP	A725
Colinet™	UTS444302EP	UTS344302	UTS244202EP	UTS9318	A501 x2	3887EP	A725
90°®	UTS4715EP	UTS3715	UTS2712EP	UTS4172	A501 x2	S3880EP	A721
Doux™	UTS4202EP	UTS3202	UTS2202EP	UTS9204	A501 x2	3887EP	A725
Greenfield™	UT4322EP	UT33322	UT2322EP	UT6501	A501 x2	3887EP	A725
Wynford®	UT45502EP	UT35502	UT24502EP	UT4511	A501 x2	3667EP	A725
Align®	UT4292EP	UT3292	UT2192EP	UT4191	A501 x2	3887EP	A725
Rizon®	UT4812EP	UT3812EP	UT2812EP	UT2081	A501 x2	3988EP	A721
Belfield™	UT4312EP	UT3312	UT2312EP	UT4301	A501 x2	3667EP	A725
Cia™	UT4362EP	UT3362	UT2262EP	UT4620	A501 x2	3887EP	A725
Voss™	UT4692EP	UT3692	UT2692EP	UT4611	A501 x2	3988EP	A721
Dartmoor®			UT2282EP	UT2031	A501 x2	3667EP	A725
Glyde™			UT2842EP	UT2721	A501 x2	3887EP	A725
Brantford®			UT2252EP	UT2021	A501 x2	3667EP	A725
Eva®			UT2232EP	UT2011	A501 x2	3669EP	A725
Gibson™			UT3002EP	UT2921	A501 x2	3669EP	A725
Genta™ LX			UT2472EP	UT2401	A501 x2	3988EP	A721

Use M-CORE mixing valve U130
Use M-CORE transfer valve U361 or U231
Reference valve section for details

M-CORE Mixing Valve	Flow Rate through shower port (GPM) @ 20 PSI	Flow Rate through shower port (GPM) @ 40 PSI	Flow Rate through shower port (GPM) @ 60 PSI	Used with M-CORE Transfer Valve
M-CORE U130	3.0	4.5	5.6	M-CORE 3 Function 6 Function (U361) or M-CORE 2 Function 3 Function (U231)

When plumbing the U361 valve to flow three shared showering devices, 50 psi or higher is recommended for optimum performance.

M-CORE® 4-Series, 3-Series and 2-Series Transfer Valve Showering Configurations

CUSTOM SHOWERING

17.188 PT



3 Showering Devices:
 (3 Independent Functions or
 3 Independent and 3 Shared Functions)
 as determined by valve selection
 Flara™ suite shown.

*mixing valve image shows M-CORE 3-Series trim

Suite	M-CORE Shower Only Trim PICK YOUR MIXING VALVE TRIM			M-CORE Transfer Valve Trim	Ceiling Mount Showerhead	Ceiling Mount Shower Arm	Ceiling Mount Shower Arm Flange	Handheld Shower with Slide Bar	Drop Ell
	4-Series	3-Series	2-Series						
Weymouth®	UTS43102EP	UTS33102	UTS232102EP	UTS32205	S1311	226651	AT2199	S12107EP	A725
Arris®	UTS42002EP	UTS32002	UTS22002EP	UTS23005	S112	226651	137488	3887EP	A725
Flara™	UTS4912EP	UTS3912	UTS2912EP	UTS4911	S6365	226651	137488	S3880EP	A725
Colinet™	UTS444302EP	UTS344302	UTS244202EP	UTS9318	S112	226651	AT2199	3887EP	A725
90°®	UTS4715EP	UTS3715	UTS2712EP	UTS4172	S6340	226651	147572	S3880EP	A721
Doux™	UTS4202EP	UTS3202	UTS2202EP	UTS9204	S176	226651	137488	3887EP	A725
Greenfield™	UT4322EP	UT33322	UT2322EP	UT6501	S6360	226651	137488	3887EP	A725
Wynford®	UT45502EP	UT35502	UT24502EP	UT4511	S6310	226651	AT2199	3667EP	A725
Align®	UT4292EP	UT3292	UT2192EP	UT4191	S176	226651	137488	3887EP	A725
Rizon®	UT4812EP	UT3812EP	UT2812EP	UT2081	6345	226651	AT2199	3988EP	A721
Belfield™	UT4312EP	UT3312	UT2312EP	UT4301	S6310	226651	AT2199	3667EP	A725
Cia™	UT4362EP	UT3362	UT2262EP	UT4620	S112	226651	137488	3887EP	A725
Voss™	UT4692EP	UT3692	UT2692EP	UT4611	S6365	226651	AT2199	3988EP	A721
Dartmoor®			UT2282EP	UT2031	6345	226651	AT2199	3667EP	A725
Glyde™			UT2842EP	UT2721	6345	226651	137488	3887EP	A725
Brantford®			UT2252EP	UT2021	6345	226651	AT2199	3667EP	A725
Eva®			UT2232EP	UT2011	6345	226651	AT2199	3669EP	A725
Gibson™			UT3002EP	UT2921	6345	226651	137488	3669EP	A725
Genta™ LX			UT2472EP	UT2401	6345	226651	137488	3988EP	A721

Use M-CORE mixing valve U130
 Use M-CORE transfer valve U361 or U231
 Reference valve section for details

M-CORE Mixing Valve	Flow Rate through shower port (GPM) @ 20 PSI	Flow Rate through shower port (GPM) @ 40 PSI	Flow Rate through shower port (GPM) @ 60 PSI	Used with M-CORE Transfer Valve
M-CORE U130	3.0	4.5	5.6	M-CORE 3 Function 6 Function (U361) or M-CORE 2 Function 3 Function (U231)

M-CORE® 4-Series, 3-Series and 2-Series Transfer Valve Showering Configurations

M-CORE® 4-SERIES, 3-SERIES OR 2-SERIES: SHOWERHEAD, HANDSHOWER & NON-DIVERTING TUB SPOUT



3 Showering Devices:
(3 Independent Functions using U231 set for independent functionality)

Flara™ suite shown.

*mixing valve image shows M-CORE 3-Series trim

Suite	M-CORE Shower Only Trim PICK YOUR MIXING VALVE TRIM			M-CORE Transfer Valve Trim	Handheld Shower with Slide Bar	Drop ELL	Non-Diverting Tub Spout
	4-Series	3-Series	2-Series				
Weymouth®	UTS43102EP	UTS33102	UTS232102EP	UTS32205	S12107EP	A725	S12105
Arris®	UTS42002EP	UTS32002	UTS22002EP	UTS23005	3887EP	A725	S16900
Flara™	UTS4912EP	UTS3912	UTS2912EP	UTS4911	S3880EP	A725	S990
Colinet™	UTS444302EP	UTS344302	UTS244202EP	UTS9318	3887EP	A725	S5001
90°®	UTS4715EP	UTS3715	UTS2712EP	UTS4172	S3880EP	A721	S3898
Doux™	UTS4202EP	UTS3202	UTS2202EP	UTS9204	3887EP	A725	S3869
Greenfield™	UT4322EP	UT33322	UT2322EP	UT6501	3887EP	A725	4326
Wynford®	UT45502EP	UT35502	UT24502EP	UT4511	3667EP	A725	195386
Align®	UT4292EP	UT3292	UT2192EP	UT4191	3887EP	A725	3892
Rizon®	UT4812EP	UT3812EP	UT2812EP	UT2081	3988EP	A721	3829
Belfield™	UT4312EP	UT3312	UT2312EP	UT4301	3667EP	A725	3858
Cia™	UT4362EP	UT3362	UT2262EP	UT4620	3887EP	A725	3347
Voss™	UT4692EP	UT3692	UT2692EP	UT4611	3988EP	A721	191956
Dartmoor®			UT2282EP	UT2031	3667EP	A725	3858
Glyde™			UT2842EP	UT2721	3887EP	A725	3829
Brantford®			UT2252EP	UT2021	3667EP	A725	3858
Eva®			UT2232EP	UT2011	3669EP	A725	3829
Gibson™			UT3002EP	UT2921	3669EP	A725	3892
Genta™ LX			UT2472EP	UT2401	3988EP	A721	3829

Use M-CORE mixing valve U130
Use M-CORE transfer valve U361 or U231
Reference valve section for details

M-CORE Mixing Valve	Flow Rate through shower port (GPM) @ 20 PSI	Flow Rate through shower port (GPM) @ 40 PSI	Flow Rate through shower port (GPM) @ 60 PSI	Used with M-CORE Transfer Valve
M-CORE U130	3.0	4.5	5.6	M-CORE 3 Function 6 Function (U361) or M-CORE 2 Function 3 Function (U231)

M-CORE transfer valve flow is the total flow when used in the shared mode.

When plumbing the U362 valve to flow three shared showering devices, 50 psi or higher is recommended for optimum performance.

M-CORE® 4-Series, 3-Series and 2-Series Transfer Valve Showering Configurations

CUSTOM SHOWERING

M-CORE® 4-SERIES, 3-SERIES OR 2-SERIES: SHOWERHEAD & HANDSHOWER



2 Showering Devices:
 (2 Independent Functions or
 2 Independent and 1 Shared Function) as
 determined by valve selection
 Flara™ suite shown.

*mixing valve image shows M-CORE 3-Series trim

Suite	M-CORE Shower Only Trim PICK YOUR MIXING VALVE TRIM			M-CORE Transfer Valve Trim	Handheld Shower with Slide Bar	Drop Ell
	4-Series	3-Series	2-Series			
Weymouth®	UTS43102EP	UTS33102	UTS232102EP	UTS32205	S12107EP	A725
Arris®	UTS42002EP	UTS32002	UTS22002EP	UTS23005	3887EP	A725
Flara™	UTS4912EP	UTS3912	UTS2912EP	UTS4911	S3880EP	A725
Colinet™	UTS444302EP	UTS344302	UTS244202EP	UTS9318	3887EP	A725
90°®	UTS4715EP	UTS3715	UTS2712EP	UTS4172	S3880EP	A721
Doux™	UTS4202EP	UTS3202	UTS2202EP	UTS9204	3887EP	A725
Greenfield™	UT4322EP	UT33322	UT2322EP	UT6501	3887EP	A725
Wynford®	UT45502EP	UT35502	UT24502EP	UT4511	3667EP	A725
Align®	UT4292EP	UT3292	UT2192EP	UT4191	3887EP	A725
Rizon®	UT4812EP	UT3812EP	UT2812EP	UT2081	3988EP	A721
Belfield™	UT4312EP	UT3312	UT2312EP	UT4301	3667EP	A725
Cia™	UT4362EP	UT3362	UT2262EP	UT4620	3887EP	A725
Voss™	UT4692EP	UT3692	UT2692EP	UT4611	3988EP	A721
Dartmoor®			UT2282EP	UT2031	3667EP	A725
Glyde™			UT2842EP	UT2721	3887EP	A725
Brantford®			UT2252EP	UT2021	3667EP	A725
Eva®			UT2232EP	UT2011	3669EP	A725
Gibson™			UT3002EP	UT2921	3669EP	A725
Genta™ LX			UT2472EP	UT2401	3988EP	A721

Use M-CORE mixing valve U130
 Use M-CORE transfer valve U361 or U231
 Reference valve section for details

M-CORE Mixing Valve	Flow Rate through shower port (GPM) @ 20 PSI	Flow Rate through shower port (GPM) @ 40 PSI	Flow Rate through shower port (GPM) @ 60 PSI	Used with M-CORE Transfer Valve
M-CORE U130	3.0	4.5	5.6	M-CORE 3 Function 6 Function (U361) or M-CORE 2 Function 3 Function (U231)

M-CORE® 4-Series, 3-Series and 2-Series Transfer Valve Showering Configurations

M-CORE® 4-SERIES, 3-SERIES OR 2-SERIES: CEILING RAINSHOWER & SHOWERHEAD



2 Showering Devices:

(2 Independent Functions or
2 Independent and 1 Shared Function) as
determined by valve selection

Flara™ suite shown.

*mixing valve image shows M-CORE 3-Series trim

Suite	M-CORE Shower Only Trim PICK YOUR MIXING VALVE TRIM			M-CORE Transfer Valve Trim	Ceiling Mount Showerhead	Ceiling Mount Shower Arm	Ceiling Mount Shower Arm Flange
	4-Series	3-Series	2-Series				
Weymouth®	UTS43102EP	UTS33102	UTS232102EP	UTS32205	S1311	226651	AT2199
Arris®	UTS42002EP	UTS32002	UTS22002EP	UTS23005	S112	226651	137488
Flara™	UTS4912EP	UTS3912	UTS2912EP	UTS4911	S6365	226651	137488
Colinet™	UTS444302EP	UTS344302	UTS244202EP	UTS9318	S112	226651	AT2199
90°®	UTS4715EP	UTS3715	UTS2712EP	UTS4172	S6340	226651	147572
Doux™	UTS4202EP	UTS3202	UTS2202EP	UTS9204	S176	226651	137488
Greenfield™	UT4322EP	UT33322	UT2322EP	UT6501	S6360	226651	137488
Wynford®	UT45502EP	UT35502	UT24502EP	UT4511	S6310	226651	AT2199
Align®	UT4292EP	UT3292	UT2192EP	UT4191	S176	226651	137488
Rizon®	UT4812EP	UT3812EP	UT2812EP	UT2081	6345	226651	AT2199
Belfield™	UT4312EP	UT3312	UT2312EP	UT4301	S6310	226651	AT2199
Cia™	UT4362EP	UT3362	UT2262EP	UT4620	S112	226651	137488
Voss™	UT4692EP	UT3692	UT2692EP	UT4611	S6365	226651	AT2199
Dartmoor®			UT2282EP	UT2031	6345	226651	AT2199
Glyde™			UT2842EP	UT2721	6345	226651	137488
Brantford®			UT2252EP	UT2021	6345	226651	AT2199
Eva®			UT2232EP	UT2011	6345	226651	AT2199
Gibson™			UT3002EP	UT2921	6345	226651	137488
Genta™ LX			UT2472EP	UT2401	6345	226651	137488

Use M-CORE mixing valve U130

Use M-CORE transfer valve U361 or U231

Reference valve section for details

M-CORE Mixing Valve	Flow Rate through shower port (GPM) @ 20 PSI	Flow Rate through shower port (GPM) @ 40 PSI	Flow Rate through shower port (GPM) @ 60 PSI	Used with M-CORE Transfer Valve
M-CORE U130	3.0	4.5	5.6	M-CORE 3 Function 6 Function (U361) or M-CORE 2 Function 3 Function (U231)

M-CORE® 4-Series, 3-Series and 2-Series Transfer Valve Showering Configurations

CUSTOM SHOWERING

M-CORE® 4-SERIES, 3-SERIES OR 2-SERIES: SHOWERHEAD & BODY SPRAYS



2 Showering Devices:
 (2 Independent Functions or
 2 Independent and 1 Shared Function) as
 determined by valve selection
 Flara™ suite shown.

*mixing valve image shows M-CORE 3-Series trim

Suite	M-CORE Shower Only Trim PICK YOUR MIXING VALVE TRIM			M-CORE Transfer Valve Trim	Bodyspray and Quantity
	4-Series	3-Series	2-Series		
Weymouth®	UTS43102EP	UTS33102	UTS232102EP	UTS32205	A501 x 2
Arris®	UTS42002EP	UTS32002	UTS22002EP	UTS23005	A501 x 2
Flara™	UTS4912EP	UTS3912	UTS2912EP	UTS4911	A501 x 2
Colinet™	UTS444302EP	UTS344302	UTS244202EP	UTS9318	A501 x 2
90°®	UTS4715EP	UTS3715	UTS2712EP	UTS4172	A501 x 2
Doux™	UTS4202EP	UTS3202	UTS2202EP	UTS9204	A501 x 2
Greenfield™	UT4322EP	UT33322	UT2322EP	UT6501	A501 x 2
Wynford®	UT45502EP	UT35502	UT24502EP	UT4511	A501 x 2
Align®	UT4292EP	UT3292	UT2192EP	UT4191	A501 x 2
Rizon®	UT4812EP	UT3812EP	UT2812EP	UT2081	A501 x 2
Belfield™	UT4312EP	UT3312	UT2312EP	UT4301	A501 x 2
Cia™	UT4362EP	UT3362	UT2262EP	UT4620	A501 x 2
Voss™	UT4692EP	UT3692	UT2692EP	UT4611	A501 x 2
Dartmoor®			UT2282EP	UT2031	A501 x 2
Glyde™			UT2842EP	UT2721	A501 x 2
Brantford®			UT2252EP	UT2021	A501 x 2
Eva®			UT2232EP	UT2011	A501 x 2
Gibson™			UT3002EP	UT2921	A501 x 2
Genta™ LX			UT2472EP	UT2401	A501 x 2

Use M-CORE mixing valve U130
 Use M-CORE transfer valve U361 or U231
 Reference valve section for details

M-CORE Mixing Valve	Flow Rate through shower port (GPM) @ 20 PSI	Flow Rate through shower port (GPM) @ 40 PSI	Flow Rate through shower port (GPM) @ 60 PSI	Used with M-CORE Transfer Valve
M-CORE U130	3.0	4.5	5.6	M-CORE 3 Function 6 Function (U361) or M-CORE 2 Function 3 Function (U231)

When plumbing the U231 or U361 valve to flow three shared showering devices, 50 psi or higher is recommended for optimum performance.

POSI-TEMP® WITH M-CORE® TRANSFER VALVE Showering Configurations

Moen has all the components necessary for you to build a custom shower spa. And, we're making it easy for you to pull together the sku numbers you need. Charts of common shower spa configurations are included so that all the components can be ordered. The charts below illustrate one layout and option of showering components. Refer to pages 429 - 460 in the Custom Showering section to choose from our wide array of showering products, styles and finishes to meet your preference. For additional assistance, call your Moen Sales Representative.



POSI-TEMP® WITH M-CORE®: SHOWERHEAD, BODY SPRAY & HANDSHOWER



3 Showering Devices:
(3 Independent Functions or
3 Independent and 3 Shared Functions)
as determined by valve selection
Arris® suite shown.

Suite	Posi-Temp® Shower Only Trim	M-CORE Transfer Valve Trim	Bodyspray and Quantity	Handheld Shower with Slide Bar	Drop Ell
Weymouth®	TS32102	UTS32205	A501 x 2	S12107EP	A725
Arris®	TS22002	UTS23005	A501 x 2	3887EP	A725
Flara™	TS2912	UTS4911	A501 x 2	S3880EP	A725
90°®	TS2712	UTS4172	A501 x 2	S3880EP	A721
Doux™	TS2202	UTS9204	A501 x 2	3887EP	A725
Greenfield™	T2222EP	UT6501	A501 x 2	3887EP	A725
Wynford®	T4502	UT4511	A501 x 2	3667EP	A725
Align®	T2192	UT4191	A501 x 2	3887EP	A725
Rizon®	T2812	UT2081	A501 x 2	3988EP	A721
Belfield™	T2312	UT4301	A501 x 2	3667EP	A725
Cia™	T2262EP	UT4620	A501 x 2	3887EP	A725
Voss™	T2692	UT4611	A501 x 2	3988EP	A721
Dartmoor®	T2182	UT2031	A501 x 2	3667EP	A725
Glyde™	T2742EP	UT2721	A501 x 2	3887EP	A725
Brantford®	T2152	UT2021	A501 x 2	3667EP	A725
Eva®	T2132	UT2011	A501 x 2	3669EP	A725
Gibson™	T2902EP	UT2921	A501 x 2	3669EP	A725
Genta™ LX	T2472EP	UT2401	A501 x 2	3988EP	A721

Use Posi-Temp® three port valve
Use M-CORE transfer valve U361 or U231

Posi-Temp® Valve	Flow Rate through shower port (GPM) @ 20 PSI	Flow Rate through shower port (GPM) @ 40 PSI	Flow Rate through shower port (GPM) @ 60 PSI	Used with M-CORE Transfer Valve
Posi-Temp® Three Port Valve	3.6	5.1	6.3	M-CORE 3 Function 6 Function (U361) or M-CORE 2 Function 3 Function (U231)

When plumbing the U361 valve to flow three shared showering devices, 50 psi or higher is recommended for optimum performance.

Posi-Temp® with M-CORE® Transfer Valve Showering Configuration

CUSTOM SHOWERING

POSI-TEMP® WITH M-CORE®: CEILING RAINSHOWER, SHOWERHEAD & HANDSHOWER



3 Showering Devices:
 (3 Independent Functions or
 3 Independent and 3 Shared Functions) as
 determined by valve selection
 Doux™ suite shown.

Suite	Posi-Temp® Shower Only Trim	M-CORE Transfer Valve Trim	Ceiling Mount Showerhead	Ceiling Mount Shower Arm	Ceiling Mount Shower Arm Flange	Handheld Shower with Slide Bar	Drop Ell
Weymouth®	TS32102	UTS32205	S1311	226651	AT2199	S12107EP	A725
Arris®	TS22002	UTS23005	S112	226651	137488	3887EP	A725
Flara™	TS2912	UTS4911	S6365	226651	137488	3988EP	A725
90°®	TS2712	UTS4172	S6340	226651	147572	S3880EP	A721
Doux™	TS2202	UTS9204	S176	226651	137488	3887EP	A725
Greenfield™	T2222EP	UT6501	S178	226651	137488	3887EP	A725
Wynford®	T4502	UT4511	S6310	226651	AT2199	3667EP	A725
Align®	T2192	UT4191	S176	226651	137488	3887EP	A725
Rizon®	T2812	UT2081	6345	226651	AT2199	3988EP	A721
Belfield™	T2312	UT4301	S6310	226651	AT2199	3667EP	A725
Cia™	T2262EP	UT4620	S112	226651	137488	3887EP	A725
Voss™	T2692	UT4611	S6365	226651	AT2199	3988EP	A721
Dartmoor®	T2182	UT2031	6345	226651	AT2199	3667EP	A725
Glyde™	T2742EP	UT2721	6345	226651	137488	3887EP	A725
Brantford®	T2152	UT2021	6345	226651	AT2199	3667EP	A725
Eva®	T2132	UT2011	6345	226651	AT2199	3669EP	A725
Gibson™	T2902EP	UT2921	6345	226651	137488	3669EP	A725
Genta™ LX	T2472EP	UT2401	6345	226651	137488	3988EP	A721

Use Posi-Temp® three port valve
 Use M-CORE transfer valve U361 or U231
 Reference valve section for details

Posi-Temp® Valve	Flow Rate through shower port (GPM) @ 20 PSI	Flow Rate through shower port (GPM) @ 40 PSI	Flow Rate through shower port (GPM) @ 60 PSI	Used with M-CORE Transfer Valve
Posi-Temp® Three Port Valve	3.6	5.1	6.3	M-CORE 3 Function 6 Function (U361) or M-CORE 2 Function 3 Function (U231)

Posi-Temp® with M-CORE® Transfer Valve Showering Configuration

POSI-TEMP® WITH M-CORE®: SHOWERHEAD, HANDSHOWER & NON-DIVERTING TUB SPOUT



3 Showering Devices:
(3 Independent Functions Only, using U231 set for independent functionality)
Doux™ suite shown.

Suite	Posi-Temp® Shower Only Trim	M-CORE Transfer Valve Trim	Handheld Shower with Slide Bar	Drop Ell	Non-Diverting Tub Spout
Weymouth®	TS32102	UTS32205	S12107EP	A725	S12105
Arris®	TS22002	UTS23005	3887EP	A725	S16900
Flara™	TS2912	UTS4911	3988EP	A725	S990
90°®	TS2712	UTS4172	S3880EP	A721	S3898
Doux™	TS2202	UTS9204	3887EP	A725	S3836
Greenfield™	T2222EP	UT6501	3887EP	A725	4326
Wynford®	T4502	UT4511	3667EP	A725	195386
Align®	T2192	UT4191	3887EP	A725	3892
Rizon®	T2812	UT2081	3988EP	A721	3829
Belfield™	T2312	UT4301	3667EP	A725	3858
Cia™	T2262EP	UT4620	3887EP	A725	3347
Voss™	T2692	UT4611	3988EP	A721	191956
Dartmoor®	T2182	UT2031	3667EP	A725	3858
Glyde™	T2742EP	UT2721	3887EP	A725	3829
Brantford®	T2152	UT2021	3667EP	A725	3858
Eva®	T2132	UT2011	3669EP	A725	3829
Gibson™	T2902EP	UT2921	3669EP	A725	3892
Genta™ LX	T2472EP	UT2401	3988EP	A721	3829

Use Posi-Temp® three port valve
Use M-CORE transfer valve U231
Reference valve section for details

Posi-Temp® Valve	Flow Rate through shower port (GPM) @ 20 PSI	Flow Rate through shower port (GPM) @ 40 PSI	Flow Rate through shower port (GPM) @ 60 PSI	Used with M-CORE Transfer Valve
Posi-Temp® Three Port Valve	3.6	5.1	6.3	M-CORE U231 set in three function independent functionality

Posi-Temp® with M-CORE® Transfer Valve Showering Configuration

CUSTOM SHOWERING

POSI-TEMP® WITH M-CORE®: SHOWERHEAD & HANDSHOWER



2 Showering Devices:
 (2 Independent Functions or
 2 Independent and 1 Shared Function)
 as determined by valve selection
 Flara™ suite shown.

Suite	Posi-Temp® Shower Only Trim	M-CORE Transfer Valve Trim	Handheld Shower with Slide Bar	Drop Ell
Weymouth®	TS32102	UTS32205	S12107EP	A725
Arris®	TS22002	UTS23005	3887EP	A725
Flara™	TS2912	UTS4911	3988EP	A725
90°®	TS2712	UTS4172	S3880EP	A721
Doux™	TS2202	UTS9204	3887EP	A725
Greenfield™	T2222EP	UT6501	3887EP	A725
Wynford®	T4502	UT4511	3667EP	A725
Align®	T2192	UT4191	3887EP	A725
Rizon®	T2812	UT2081	3988EP	A721
Belfield™	T2312	UT4301	3667EP	A725
Cia™	T2262EP	UT4620	3887EP	A725
Voss™	T2692	UT4611	3988EP	A721
Dartmoor®	T2182	UT2031	3667EP	A725
Glyde™	T2742EP	UT2721	3887EP	A725
Brantford®	T2152	UT2021	3667EP	A725
Eva®	T2132	UT2011	3669EP	A725
Gibson™	T2902EP	UT2921	3669EP	A725
Genta™ LX	T2472EP	UT2401	3988EP	A721

Use Posi-Temp® three port valve
 Use M-CORE transfer valve U361 or U231
 Reference valve section for more options and details

Posi-Temp® Valve	Flow Rate through shower port (GPM) @ 20 PSI	Flow Rate through shower port (GPM) @ 40 PSI	Flow Rate through shower port (GPM) @ 60 PSI	Used with M-CORE Transfer Valve
Posi-Temp® Three Port Valve	3.6	5.1	6.3	M-CORE 3 Function 6 Function (U361) or M-CORE 2 Function 3 Function (U231)

When plumbing the U361 valve to flow three shared showering devices, 50 psi or higher is recommended for optimum performance.

Posi-Temp® with M-CORE® Transfer Valve Showering Configuration

POSI-TEMP® WITH M-CORE®: SHOWERHEAD & BODY SPRAYS



2 Showering Devices:
(2 Independent Functions or
2 Independent and 1 Shared Function)
as determined by valve selection
Flara™ suite shown.

Suite	Posi-Temp® Shower Only Trim	M-CORE Transfer Valve Trim	Bodyspray and Quantity
Weymouth®	TS32102	UTS32205	A501 x 2
Arris®	TS22002	UTS23005	A501 x 2
Flara™	TS2912	UTS4911	A501 x 2
90°®	TS2712	UTS4172	A501 x 2
Doux™	TS2202	UTS9204	A501 x 2
Greenfield™	T2222EP	UT6501	A501 x 2
Wynford®	T4502	UT4511	A501 x 2
Align®	T2192	UT4191	A501 x 2
Rizon®	T2812	UT2081	A501 x 2
Belfield™	T2312	UT4301	A501 x 2
Cia™	T2262EP	UT4620	A501 x 2
Voss™	T2692	UT4611	A501 x 2
Dartmoor®	T2182	UT2031	A501 x 2
Glyde™	T2742EP	UT2721	A501 x 2
Brantford®	T2152	UT2021	A501 x 2
Eva®	T2132	UT2011	A501 x 2
Gibson™	T2902EP	UT2921	A501 x 2
Genta™ LX	T2472EP	UT2401	A501 x 2

Use Posi-Temp® three port valve
Use M-CORE transfer valve U361 or U231
Reference valve section for more options and details

Posi-Temp® Valve	Flow Rate through shower port (GPM) @ 20 PSI	Flow Rate through shower port (GPM) @ 40 PSI	Flow Rate through shower port (GPM) @ 60 PSI	Used with M-CORE Transfer Valve
Posi-Temp® Three Port Valve	3.6	5.1	6.3	M-CORE 3 Function 6 Function (U361) or M-CORE 2 Function 3 Function (U231)

When plumbing the U361 valve to flow three shared showering devices, 50 psi or higher is recommended for optimum performance.

Posi-Temp® with M-CORE® Transfer Valve Showering Configuration

CUSTOM SHOWERING

POSI-TEMP® WITH M-CORE®: SHOWERHEAD & NON-DIVERTING TUB SPOUT

























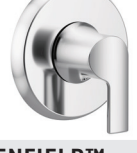

2 Showering Devices:
 (2 Independent Functions; use U231 transfer valve set for 2 Function independent functionality)
 Wynford® suite shown.

Suite	Posi-Temp® Shower Only Trim	M-CORE Transfer Valve Trim	Non-Diverting Tub Spout
Weymouth®	TS32102	UTS32205	S12105
Arris®	TS22002	UTS23005	S16900
Flara™	TS2912	UTS4911	S990
90°®	TS2712	UTS4172	S3898
Doux™	TS2202	UTS9204	S3869
Greenfield™	T2222EP	UT6501	4326
Wynford®	T4502	UT4511	195386
Align®	T2192	UT4191	3892
Rizon®	T2812	UT2081	3829
Belfield™	T2312	UT4301	3858
Cia™	T2262EP	UT4620	3347
Voss™	T2692	UT4611	191956
Dartmoor®	T2182	UT2031	3858
Glyde™	T2742EP	UT2721	3829
Brantford®	T2152	UT2021	3858
Eva®	T2132	UT2011	3829
Gibson™	T2902EP	UT2921	3892
Genta™ LX	T2472EP	UT2401	3829

























Use Posi-Temp® three port valve
 Use M-CORE transfer valve U361 or U231
 Reference valve section for more options and details

Posi-Temp® Valve	Flow Rate through shower port (GPM) @ 20 PSI	Flow Rate through shower port (GPM) @ 40 PSI	Flow Rate through shower port (GPM) @ 60 PSI	Used with M-CORE Transfer Valve
Posi-Temp® Three Port Valve	3.6	5.1	6.3	M-CORE U231 set in three function independent functionality

M-CORE® Transfer Valve Showering Options







		MODEL	LIST	FINISH/CONNECT	CASE QTY
	M-CORE® TRANSFER VALVE TRIM - PREMIUM • use with the M-CORE® transfer valve • valve: sold separately  	UTS32205	459.95	Chrome	12
		UTS32205BN	525.60	Brushed Nickel	12
		UTS32205NL	525.60	Polished Nickel	12
		UTS32205BG	525.60	Brushed Gold	12
		UTS32205BL	559.50	Matte Black	12
		UTS32205ORB	559.50	Oil Rubbed Bronze	12
	M-CORE® TRANSFER VALVE TRIM - PREMIUM • use with the M-CORE® transfer valve • valve: sold separately  	UTS23005	434.20	Chrome	12
		UTS23005BL	557.70	Matte Black	12
	M-CORE® TRANSFER VALVE TRIM - PREMIUM • use with the M-CORE® transfer valve • valve: sold separately  	UTS4911	330.70	Chrome	12
		UTS4911BN	449.10	Brushed Nickel	12
		UTS4911NL	449.10	Polished Nickel	12
		UTS4911BG	449.10	Brushed Gold	12
	M-CORE® TRANSFER VALVE TRIM - PREMIUM • use with the M-CORE® transfer valve • valve: sold separately  	UTS9381	315.90	Chrome	12
		UTS9381BN	428.85	Brushed Nickel	12
		UTS9381BG	428.85	Brushed Gold	12
		UTS9381BL	471.75	Matte Black	12
	M-CORE® TRANSFER VALVE TRIM - PREMIUM • use with the M-CORE® transfer valve • valve: sold separately  	UTS4172	297.50	Chrome	12
		UTS4172BN	370.40	Brushed Nickel	12
		Q3  UTS4172BL	386.75	Matte Black	12
	M-CORE® TRANSFER VALVE TRIM - PREMIUM • use with the M-CORE® transfer valve • valve: sold separately  	UTS9204	314.10	Chrome	12
		UTS9204BN	413.15	Brushed Nickel	12
		UTS9204BL	445.10	Matte Black	12
	M-CORE® TRANSFER VALVE TRIM • use with the M-CORE® transfer valve • valve: sold separately  	NEW! Q3 UT6501	227.70	Chrome	12
		UT6501BN	280.30	Brushed Nickel	12
		UT6501BG	280.30	Brushed Gold	12
		UT6501BL	300.80	Matte Black	12
	M-CORE® TRANSFER VALVE TRIM • use with the M-CORE® transfer valve • valve: sold separately  	UT4511	227.70	Chrome	12
		UT4511BN	280.30	Brushed Nickel	12
		UT4511ORB	300.80	Oil Rubbed Bronze	12

M-CORE® Transfer Valve Showering Options



















		MODEL	LIST	FINISH/CONNECT	CASE QTY
 <p>ALIGN®</p> <p>M-CORE® TRANSFER VALVE TRIM</p> <ul style="list-style-type: none"> • use with the M-CORE® transfer valve • valve: sold separately <p> </p>		UT4191	227.70	Chrome	12
		UT4191BN	280.30	Brushed Nickel	12
		UT4191BG	280.30	Brushed Gold	12
		UT4191BL	300.80	Matte Black	12
 <p>RIZON®</p> <p>M-CORE® TRANSFER VALVE TRIM</p> <ul style="list-style-type: none"> • use with the M-CORE® transfer valve • valve: sold separately <p> </p>		UT2081	227.70	Chrome	12
		UT2081BL	300.85	Matte Black	12
 <p>BELFIELD™</p> <p>M-CORE® TRANSFER VALVE TRIM</p> <ul style="list-style-type: none"> • use with the M-CORE® transfer valve • valve: sold separately <p> </p>		UT4301	222.00	Chrome	12
		UT4301BN	272.75	Brushed Nickel	12
		UT4301NL	272.75	Polished Nickel	12
		Q3  UT4301BL	277.50	Matte Black	12
		UT4301ORB	292.45	Oil Rubbed Bronze	12
 <p>CIA™</p> <p>M-CORE® TRANSFER VALVE TRIM</p> <ul style="list-style-type: none"> • use with the M-CORE® transfer valve • valve: sold separately <p> </p>		UT4620	218.50	Chrome	12
		UT4620BN	268.95	Brushed Nickel	12
		UT4620BG	268.95	Brushed Gold	12
		UT4620BL	288.65	Matte Black	12
 <p>VOSS™</p> <p>M-CORE® TRANSFER VALVE TRIM</p> <ul style="list-style-type: none"> • use with the M-CORE® transfer valve • valve: sold separately <p> </p>		UT4611	218.50	Chrome	12
		UT4611BN	268.95	Brushed Nickel	12
		UT4611NL	268.95	Polished Nickel	12
		UT4611BG	268.95	Brushed Gold	12
		UT4611ORB	288.65	Oil Rubbed Bronze	12
 <p>DARTMOOR™</p> <p>M-CORE® TRANSFER VALVE TRIM</p> <ul style="list-style-type: none"> • use with the M-CORE® transfer valve • valve: sold separately <p> </p>		UT2031	188.60	Chrome	12
		UT2031BN	229.05	Brushed Nickel	12
		UT2031BL	244.80	Matte Black	12
		UT2031ORB	244.80	Oil Rubbed Bronze	12
 <p>GLYDE™</p> <p>M-CORE® TRANSFER VALVE TRIM</p> <ul style="list-style-type: none"> • use with the M-CORE® transfer valve • valve: sold separately <p> </p>		UT2721	188.60	Chrome	12
		UT2721BN	229.05	Brushed Nickel	12
		UT2721BL	244.80	Matte Black	12
 <p>BRANTFORD®</p> <p>M-CORE® TRANSFER VALVE TRIM</p> <ul style="list-style-type: none"> • use with the M-CORE® transfer valve • valve: sold separately <p> </p>		UT2021	188.60	Chrome	12
		UT2021BN	229.05	Brushed Nickel	12
		UT2021ORB	244.80	Oil Rubbed Bronze	12

CUSTOM SHOWERING

M-CORE® Transfer Valve Showering Options

		MODEL	LIST	FINISH/CONNECT	CASE QTY	
EVA®	M-CORE® TRANSFER VALVE TRIM					
		• use with the M-CORE® transfer valve	UT2011	188.60	Chrome	12
		• valve: sold separately	UT2011BN	229.05	Brushed Nickel	12
			UT2011ORB	244.80	Oil Rubbed Bronze	12
						
GIBSON™	M-CORE® TRANSFER VALVE TRIM					
		• use with the M-CORE® transfer valve	UT2921	188.60	Chrome	12
		• valve: sold separately	UT2921BN	229.40	Brushed Nickel	12
			UT2921BL	245.30	Matte Black	12
						
GENTA™ LX	M-CORE® TRANSFER VALVE TRIM					
		• use with the M-CORE® transfer valve	UT2401	183.70	Chrome	12
		• valve: sold separately	UT2401BN	229.05	Brushed Nickel	12
			UT2401BL	244.80	Matte Black	12
						

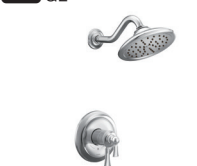



M-CORE® 4-Series Shower Only Shower Options

		MODEL	LIST	FINISH/CONNECT	CASE QTY
WEYMOUTH®	M-CORE® 4-SERIES SHOWER ONLY TRIM - PREMIUM				
	<ul style="list-style-type: none"> showerhead: two-function eco-performance rainshower showerhead size: 9" diameter includes: thermostatic cartridge with volume and temperature control valve: sold separately 	1.75 GPM (6.65 L/min) max.			
		UTS43102EP	1057.20	Chrome	3
		UTS43102EPBN	1415.85	Brushed Nickel	3
		UTS43102EPNL	1415.85	Polished Nickel	3
		UTS43102EPBG	1415.85	Brushed Gold	3
		UTS43102EPBL	1543.75	Matte Black	3
	UTS43102EPORB	1543.75	Oil Rubbed Bronze	3	
					
ARRIS®	M-CORE® 4-SERIES SHOWER ONLY TRIM - PREMIUM				
	<ul style="list-style-type: none"> showerhead: single-function eco-performance rainshower showerhead size: 10" diameter includes: thermostatic cartridge with volume and temperature control valve: sold separately 	1.75 GPM (6.65 L/min) max.			
		UTS42002EP	1023.70	Chrome	3
		UTS42002EPBL	1511.05	Matte Black	3
					
FLARA™	M-CORE® 4-SERIES SHOWER ONLY TRIM - PREMIUM				
	<ul style="list-style-type: none"> showerhead: single-function eco-performance rainshower showerhead size: 6" diameter includes: thermostatic cartridge with volume and temperature control valve: sold separately 	1.75 GPM (6.65 L/min) max.			
		UTS4912EP	783.50	Chrome	4
		UTS4912EPBN	1032.20	Brushed Nickel	4
		UTS4912EPNL	1032.20	Polished Nickel	4
	UTS4912EPBG	1032.20	Brushed Gold	4	
					
COLINET™	M-CORE® 4-SERIES SHOWER ONLY TRIM - PREMIUM				
	<ul style="list-style-type: none"> showerhead: single-function eco-performance rainshower showerhead size: 10" diameter includes: thermostatic cartridge with volume and temperature control valve: sold separately 	1.75 GPM (6.65 L/min) max.			
		UTS444302EP	754.35	Chrome	3
		UTS444302EPBN	991.75	Brushed Nickel	3
		UTS444302EPBG	991.75	Brushed Gold	3
		UTS444302EPBL	1077.50	Matte Black	3
					
90™	M-CORE® 4-SERIES SHOWER ONLY TRIM - PREMIUM				
	<ul style="list-style-type: none"> showerhead: single-function eco-performance rainshower showerhead size: 6" diameter includes: thermostatic cartridge with volume and temperature control valve: sold separately 	1.75 GPM (6.65 L/min) max.			
		Q2  UTS4715EP	655.10	Chrome	4
		Q2  UTS4715EPBN	1137.00	Brushed Nickel	4
		Q3  UTS4715EPBL	1149.20	Matte Black	4
					
DOUX™	M-CORE® 4-SERIES SHOWER ONLY TRIM - PREMIUM				
	<ul style="list-style-type: none"> showerhead: single-function eco-performance rainshower showerhead size: 6-3/4" diameter includes: thermostatic cartridge with volume and temperature control valve: sold separately 	1.75 GPM (6.65 L/min) max.			
		UTS4202EP	679.35	Chrome	4
		UTS4202EPBN	861.25	Brushed Nickel	4
		UTS4202EPBL	954.50	Matte Black	4
					
GREENFIELD™	M-CORE® 4-SERIES SHOWER ONLY TRIM				
	<ul style="list-style-type: none"> showerhead: single-function eco-performance rainshower showerhead size: 6-3/4" diameter includes: thermostatic cartridge with volume and temperature control valve: separately 	1.75 GPM (6.65 L/min) max.			
		UT4322EP	549.15	Chrome	4
		UT4322EPBN	831.00	Brushed Nickel	4
		UT4322EPBG	831.00	Brushed Gold	4
	UT4322EPBL	900.60	Matte Black	4	
					
WYNFORD®	M-CORE® 4-SERIES SHOWER ONLY TRIM				
	<ul style="list-style-type: none"> showerhead: single-function eco-performance rainshower showerhead size: 7" diameter includes: thermostatic cartridge with volume and temperature control valve: sold separately 	1.75 GPM (6.65 L/min) max.			
		UT45502EP	549.15	Chrome	4
		UT45502EPBN	831.00	Brushed Nickel	4
		UT45502EPORB	885.55	Oil Rubbed Bronze	4
					















CUSTOM SHOWERING

M-CORE® 4-Series Shower Only Shower Options

CUSTOM SHOWERING

			MODEL	LIST	FINISH/CONNECT	CASE QTY			
ALIGN® M-CORE® 4-SERIES SHOWER ONLY TRIM									
	<ul style="list-style-type: none"> • showerhead: single-function eco-performance rainshower • showerhead size: 7" diameter • includes: thermostatic cartridge with volume and temperature control • valve: sold separately 	1.75 GPM (6.65 L/min) max.	UT4292EP	549.15	Chrome	4			
			UT4292EPBN	831.00	Brushed Nickel	4			
			UT4292EPBG	831.00	Brushed Gold	4			
			UT4292EPBL	900.60	Matte Black	4			
			IMMERSSION®						
RIZON® M-CORE® 4-SERIES SHOWER ONLY TRIM									
	<ul style="list-style-type: none"> • showerhead: single-function eco-performance rainshower • showerhead size: 6-3/4" diameter • includes: thermostatic cartridge with volume and temperature control • valve: sold separately 	1.75 GPM (6.65 L/min) max.	UT4812EP	549.15	Chrome	4			
			UT4812EPBL	885.55	Matte Black	4			
			IMMERSSION®						
			BELFIELD™ M-CORE® 4-SERIES SHOWER ONLY TRIM						
				<ul style="list-style-type: none"> • showerhead: single-function eco-performance rainshower • showerhead size: 7" diameter • includes: thermostatic cartridge with volume and temperature control • valve: sold separately 	1.75 GPM (6.65 L/min) max.	Q2 UT4312EP	524.85	Chrome	4
Q2 UT4312EPBN	779.10	Brushed Nickel				4			
Q2 UT4312EPNL	779.10	Polished Nickel				4			
Q3 UT4312EPBL	797.75	Matte Black				4			
Q2 UT4312EPORB	865.95	Oil Rubbed Bronze				4			
IMMERSSION®									
CIA™ M-CORE® 4-SERIES SHOWER ONLY TRIM									
	<ul style="list-style-type: none"> • showerhead: single-function eco-performance rainshower • showerhead size: 10" diameter • includes: thermostatic cartridge with volume and temperature control • valve: sold separately 	1.75 GPM (6.65 L/min) max.	UT4362EP	532.50	Chrome	3			
			UT4362EPBN	802.95	Brushed Nickel	3			
			UT4362EPBG	802.95	Brushed Gold	3			
			UT4362EPBL	869.75	Matte Black	3			
			IMMERSSION®						
VOSS™ M-CORE® 4-SERIES SHOWER ONLY TRIM									
	<ul style="list-style-type: none"> • showerhead: single-function eco-performance rainshower • showerhead size: 6" diameter • includes: thermostatic cartridge with volume and temperature control • valve: sold separately 	1.75 GPM (6.65 L/min) max.	Q2 UT4692EP	532.50	Chrome	4			
			Q2 UT4692EPBN	802.95	Brushed Nickel	4			
			Q2 UT4692EPNL	802.95	Polished Nickel	4			
			Q2 UT4692EPBG	802.95	Brushed Gold	4			
			Q3 UT4692EPBL	810.70	Matte Black	4			
			Q2 UT4692EPORB	855.35	Oil Rubbed Bronze	4			
IMMERSSION®									











M-CORE® 3-Series Shower Only Shower Options

		MODEL	LIST	FINISH/CONNECT	CASE QTY
 <p>WEYMOUTH®</p>	<p>M-CORE® 3-SERIES SHOWER ONLY TRIM - PREMIUM</p> <ul style="list-style-type: none"> • showerhead: two-function rainshower • showerhead size: 9" diameter • includes: pressure balanced cartridge with volume and temperature control • valve: sold separately <p>  IMMERSION®</p>	2.5 GPM (9.5 L/min) max.			
		UTS33102	922.20	Chrome	3
		UTS33102BN	1280.85	Brushed Nickel	3
		UTS33102NL	1280.85	Polished Nickel	3
		UTS33102BG	1280.85	Brushed Gold	3
		UTS33102BL	1408.75	Matte Black	3
		UTS33102ORB	1408.75	Oil Rubbed Bronze	3
		1.75 GPM (6.65 L/min) max.			
		UTS33102EP	922.20	Chrome	3
		UTS33102EPBN	1280.85	Brushed Nickel	3
		UTS33102EPNL	1280.85	Polished Nickel	3
		UTS33102EPBG	1280.85	Brushed Gold	3
		UTS33102EPBL	1408.75	Matte Black	3
		UTS33102EPORB	1408.75	Oil Rubbed Bronze	3
 <p>ARRIS®</p>	<p>M-CORE® 3-SERIES SHOWER ONLY TRIM - PREMIUM</p> <ul style="list-style-type: none"> • showerhead: single-function rainshower • showerhead size: 10" diameter • includes: pressure balanced cartridge with volume and temperature control • valve: sold separately <p>  IMMERSION®</p>	2.5 GPM (9.5 L/min) max.			
		UTS32002	888.70	Chrome	3
		UTS32002BL	1376.05	Matte Black	3
		1.75 GPM (6.65 L/min) max.			
		UTS32002EP	888.70	Chrome	3
		UTS32002EPBL	1376.05	Matte Black	3
 <p>FLARATM™</p>	<p>M-CORE® 3-SERIES SHOWER ONLY TRIM - PREMIUM</p> <ul style="list-style-type: none"> • showerhead: single-function rainshower • showerhead size: 6" diameter • includes: pressure balanced cartridge with volume and temperature control • valve: sold separately <p>  IMMERSION®</p>	2.5 GPM (9.5 L/min) max.			
		UTS3912	648.50	Chrome	4
		UTS3912BN	897.20	Brushed Nickel	4
		UTS3912NL	897.20	Polished Nickel	4
		UTS3912BG	897.20	Brushed Gold	4
		1.75 GPM (6.65 L/min) max.			
		UTS3912EP	648.50	Chrome	4
		UTS3912EPBN	897.20	Brushed Nickel	4
UTS3912EPNL	897.20	Polished Nickel	4		
UTS3912EPBG	897.20	Brushed Gold	4		
 <p>COLINET™</p>	<p>M-CORE® 3-SERIES SHOWER ONLY TRIM - PREMIUM</p> <ul style="list-style-type: none"> • showerhead: single-function rainshower • showerhead size: 10" diameter • includes: pressure balanced cartridge with volume and temperature control • valve: sold separately <p>  IMMERSION®</p>	2.5 GPM (9.5 L/min) max.			
		UTS344302	619.35	Chrome	3
		UTS344302BN	856.75	Brushed Nickel	3
		UTS344302BG	856.75	Brushed Gold	3
		UTS344302BL	942.50	Matte Black	3
		1.75 GPM (6.65 L/min) max.			
		UTS344302EP	619.35	Chrome	3
		UTS344302EPBN	856.75	Brushed Nickel	3
		UTS344302EPBG	856.75	Brushed Gold	3
		UTS344302EPBL	942.50	Matte Black	3
 <p>90°™</p>	<p>M-CORE® 3-SERIES SHOWER ONLY TRIM - PREMIUM</p> <ul style="list-style-type: none"> • showerhead: single-function rainshower • showerhead size: 6" diameter • includes: pressure balanced cartridge with volume and temperature control • valve: sold separately <p>  IMMERSION®</p>	2.5 GPM (9.5 L/min) max.			
		UTS3715	520.10	Chrome	4
		UTS3715BN	1002.00	Brushed Nickel	4
		UTS3715BL	1014.20	Matte Black	4
		1.75 GPM (6.65 L/min) max.			
		UTS3715EP	520.10	Chrome	4
		UTS3715EPBN	1002.00	Brushed Nickel	4
		UTS3715EPBL	1014.20	Matte Black	4





CUSTOM SHOWERING

M-CORE® 3-Series Shower Only Shower Options

CUSTOM SHOWERING

		MODEL	LIST	FINISH/CONNECT	CASE QTY	
	M-CORE® 3-SERIES SHOWER ONLY TRIM - PREMIUM					
	<ul style="list-style-type: none"> • showerhead: single-function rainshower • showerhead size: 6-3/4" diameter • includes: pressure balanced cartridge with volume and temperature control • valve: sold separately 	2.5 GPM (9.5 L/min) max.				
		UTS3202	544.35	Chrome	4	
		UTS3202BN	726.25	Brushed Nickel	4	
		UTS3202BL	819.50	Matte Black	4	
		<ul style="list-style-type: none"> • showerhead: single-function rainshower • showerhead size: 6-3/4" diameter • includes: pressure balanced cartridge with volume and temperature control • valve: sold separately 	1.75 GPM (6.65 L/min) max.			
			UTS3202EP	544.35	Chrome	4
			UTS3202EPBN	726.25	Brushed Nickel	4
		UTS3202EPBL	819.50	Matte Black	4	
		M-CORE® 3-SERIES SHOWER ONLY TRIM				
<p>NEW! Q3</p> <ul style="list-style-type: none"> • showerhead: single-function rainshower • showerhead size: 6-3/4" diameter • includes: pressure balanced cartridge with volume and temperature control • valve: sold separately 		2.5 GPM (9.5 L/min) max.				
		UT33322	414.15	Chrome	3	
		UT33322BN	696.00	Brushed Nickel	3	
		UT33322BG	696.00	Brushed Gold	3	
		UT33322BL	765.60	Matte Black	3	
		<ul style="list-style-type: none"> • showerhead: single-function rainshower • showerhead size: 6-3/4" diameter • includes: pressure balanced cartridge with volume and temperature control • valve: sold separately 	1.75 GPM (6.65 L/min) max.			
			UT33322EP	414.15	Chrome	3
			UT33322EPBN	696.00	Brushed Nickel	3
			UT33322EPBG	696.00	Brushed Gold	3
	UT33322EPBL	765.60	Matte Black	3		
	M-CORE® 3-SERIES SHOWER ONLY TRIM					
	<ul style="list-style-type: none"> • showerhead: single-function rainshower • showerhead size: 7" diameter • includes: pressure balanced cartridge with volume and temperature control • valve: sold separately 	2.5 GPM (9.5 L/min) max.				
		UT35502	414.15	Chrome	4	
		UT35502BN	696.00	Brushed Nickel	4	
		UT35502ORB	750.55	Oil Rubbed Bronze	4	
		<ul style="list-style-type: none"> • showerhead: single-function rainshower • showerhead size: 7" diameter • includes: pressure balanced cartridge with volume and temperature control • valve: sold separately 	1.75 GPM (6.65 L/min) max.			
			UT35502EP	414.15	Chrome	4
			UT35502EPBN	696.00	Brushed Nickel	4
		UT35502EPORB	750.55	Oil Rubbed Bronze	4	
		M-CORE® 3-SERIES SHOWER ONLY TRIM				
<ul style="list-style-type: none"> • showerhead: single-function rainshower • showerhead size: 6-3/4" diameter • includes: pressure balanced cartridge with volume and temperature control • valve: sold separately 		2.5 GPM (9.5 L/min) max.				
		UT3292	414.15	Chrome	4	
		UT3292BN	696.00	Brushed Nickel	4	
		UT3292BG	696.00	Brushed Gold	4	
		UT3292BL	765.60	Matte Black	4	
		<ul style="list-style-type: none"> • showerhead: single-function rainshower • showerhead size: 6-3/4" diameter • includes: pressure balanced cartridge with volume and temperature control • valve: sold separately 	1.75 GPM (6.65 L/min) max.			
			UT3292EP	414.15	Chrome	4
			UT3292EPBN	696.00	Brushed Nickel	4
			UT3292EPBG	696.00	Brushed Gold	4
	UT3292EPBL	765.60	Matte Black	4		
	M-CORE® 3-SERIES SHOWER ONLY TRIM					
	<ul style="list-style-type: none"> • showerhead: single-function eco-performance rainshower • showerhead size: 6-3/4" diameter • includes: pressure balanced cartridge with volume and temperature control • valve: sold separately 	1.75 GPM (6.65 L/min) max.				
		UT3812EP	414.15	Chrome	4	
		UT3812EPBL	750.55	Matte Black	4	
	M-CORE® 3-SERIES SHOWER ONLY TRIM					
	<ul style="list-style-type: none"> • showerhead: single-function rainshower • showerhead size: 7" diameter • includes: pressure balanced cartridge with volume and temperature control • valve: sold separately 	2.5 GPM (9.5 L/min) max.				
		UT3312	389.85	Chrome	4	
		UT3312BN	644.10	Brushed Nickel	4	
		UT3312NL	644.10	Polished Nickel	4	
		UT3312BL	662.75	Matte Black	4	
		<ul style="list-style-type: none"> • showerhead: single-function rainshower • showerhead size: 7" diameter • includes: pressure balanced cartridge with volume and temperature control • valve: sold separately 	1.75 GPM (6.65 L/min) max.			
			UT3312ORB	730.95	Oil Rubbed Bronze	4
			UT3312EP	389.85	Chrome	4
			UT3312EPBN	644.10	Brushed Nickel	4
UT3312EPNL			644.10	Polished Nickel	4	
	UT3312EPBL	662.75	Matte Black	4		
	UT3312EPORB	730.95	Oil Rubbed Bronze	4		

























M-CORE® 3-Series Shower Only Shower Options

		MODEL	LIST	FINISH/CONNECT	CASE QTY
CIA™	M-CORE® 3-SERIES SHOWER ONLY TRIM				
 <ul style="list-style-type: none"> • showerhead: single-function rainshower • showerhead size: 10" diameter • includes: pressure balanced cartridge with volume and temperature control • valve: sold separately 		2.5 GPM (9.5 L/min) max.			
		UT3362	397.50	Chrome	3
		UT3362BN	667.95	Brushed Nickel	3
		UT3362BG	667.95	Brushed Gold	3
		UT3362BL	734.75	Matte Black	3
		1.75 GPM (6.65 L/min) max.			
		UT3362EP	397.50	Chrome	3
		UT3362EPBN	667.95	Brushed Nickel	3
		UT3362EPBG	667.95	Brushed Gold	3
		UT3362EPBL	734.75	Matte Black	3
VOSS™	M-CORE® 3-SERIES SHOWER ONLY TRIM				
 <ul style="list-style-type: none"> • showerhead: single-function rainshower • showerhead size: 6" diameter • includes: pressure balanced cartridge with volume and temperature control • valve: sold separately 		2.5 GPM (9.5 L/min) max.			
		UT3692	397.50	Chrome	4
		UT3692BN	667.95	Brushed Nickel	4
		UT3692NL	667.95	Polished Nickel	4
		UT3692BG	667.95	Brushed Gold	4
		Q3 NEW! UT3692BL	675.70	Matte Black	4
		UT3692ORB	720.35	Oil Rubbed Bronze	4
		1.75 GPM (6.65 L/min) max.			
		UT3692EP	397.50	Chrome	4
		UT3692EPBN	667.95	Brushed Nickel	4
		UT3692EPNL	667.95	Polished Nickel	4
		UT3692EPBG	667.95	Brushed Gold	4
		Q3 NEW! UT3692EPBL	675.70	Matte Black	4
		UT3692EPORB	720.35	Oil Rubbed Bronze	4



















CUSTOM SHOWERING

M-CORE® 2-Series Shower Only Shower Options

CUSTOM SHOWERING

		MODEL	LIST	FINISH/CONNECT	CASE QTY		
 	M-CORE® 2-SERIES SHOWER ONLY TRIM - PREMIUM <ul style="list-style-type: none"> • showerhead: two-function eco-performance rainshower • showerhead size: 9" diameter • includes: pressure balanced cartridge with temperature control • valve: sold separately 	1.75 GPM (6.65 L/min) max.					
		UTS232102EP	879.65	Chrome	3		
		UTS232102EPBN	1232.15	Brushed Nickel	3		
		UTS232102EPNL	1232.15	Polished Nickel	3		
		UTS232102EPBG	1232.15	Brushed Gold	3		
		UTS232102EPBL	1320.20	Matte Black	3		
		UTS232102EPORB	1320.20	Oil Rubbed Bronze	3		
 	M-CORE® 2-SERIES SHOWER ONLY TRIM - PREMIUM <ul style="list-style-type: none"> • showerhead: single-function eco-performance rainshower • showerhead size: 10" diameter • includes: pressure balanced cartridge with temperature control • valve: sold separately 	1.75 GPM (6.65 L/min) max.					
		UTS22002EP	841.05	Chrome	3		
		UTS22002EPBL	1282.75	Matte Black	3		
		 	M-CORE® 2-SERIES SHOWER ONLY TRIM - PREMIUM <ul style="list-style-type: none"> • showerhead: single-function eco-performance rainshower • showerhead size: 6" diameter • includes: pressure balanced cartridge with temperature control • valve: sold separately 	1.75 GPM (6.65 L/min) max.			
				UTS2912EP	585.15	Chrome	4
				UTS2912EPBN	802.25	Brushed Nickel	4
				UTS2912EPNL	802.25	Polished Nickel	4
UTS2912EPBG	802.25			Brushed Gold	4		
 	M-CORE® 2-SERIES SHOWER ONLY TRIM - PREMIUM <ul style="list-style-type: none"> • showerhead: single-function eco-performance rainshower • showerhead size: 10" diameter • includes: pressure balanced cartridge with temperature control • valve: sold separately 			1.75 GPM (6.65 L/min) max.			
				UTS244202EP	566.30	Chrome	3
		UTS244202EPBN	773.90	Brushed Nickel	3		
		UTS244202EPBG	773.90	Brushed Gold	3		
		UTS244202EPBL	836.15	Matte Black	3		
		 	M-CORE® 2-SERIES SHOWER ONLY TRIM - PREMIUM <ul style="list-style-type: none"> • showerhead: single-function eco-performance rainshower • showerhead size: 6" diameter • includes: pressure balanced cartridge with temperature control • valve: sold separately 	1.75 GPM (6.65 L/min) max.			
				UTS2712EP	459.05	Chrome	4
UTS2712EPBN	727.70			Brushed Nickel	4		
Q3  UTS2712EPBL	757.45			Matte Black	4		
 	M-CORE® 2-SERIES SHOWER ONLY TRIM - PREMIUM <ul style="list-style-type: none"> • showerhead: single-function eco-performance rainshower • showerhead size: 6-3/4" diameter • includes: pressure balanced cartridge with temperature control • valve: sold separately 			1.75 GPM (6.65 L/min) max.			
				UTS2202EP	484.60	Chrome	4
				UTS2202EPBN	634.60	Brushed Nickel	4
		UTS2202EPBL	683.05	Matte Black	4		
		 	M-CORE® 2-SERIES SHOWER ONLY TRIM <ul style="list-style-type: none"> • showerhead: single-function eco-performance rainshower • showerhead size: 3-5/8" diameter • includes: pressure balanced cartridge with temperature control • valve: sold separately 	1.75 GPM (6.65 L/min) max.			
				NEW! Q3 UT2322EP	348.50	Chrome	3
				UT2322EPBN	530.65	Brushed Nickel	3
UT2322EPBG	530.65			Brushed Gold	3		
UT2322EPBL	571.15			Matte Black	3		
 	M-CORE® 2-SERIES SHOWER ONLY TRIM <ul style="list-style-type: none"> • showerhead: single-function eco-performance rainshower • showerhead size: 5-7/8" diameter • includes: pressure balanced cartridge with temperature control • valve: sold separately 			1.75 GPM (6.65 L/min) max.			
				UT24502EP	348.50	Chrome	3
		UT24502EPBN	530.65	Brushed Nickel	3		
		UT24502EPORB	571.05	Oil Rubbed Bronze	3		

































M-CORE® 2-Series Shower Only Shower Options

		MODEL	LIST	FINISH/CONNECT	CASE QTY
ALIGN® M-CORE® 2-SERIES SHOWER ONLY TRIM					
 <ul style="list-style-type: none"> • showerhead: single-function eco-performance • showerhead size: 3-5/8" diameter • red/blue markings: included • includes: pressure balanced cartridge with temperature control • valve: sold separately 		1.75 GPM (6.65 L/min) max.			
		UT2192EP	348.50	Chrome	12
		UT2192EPBN	530.65	Brushed Nickel	12
		UT2192EPBG	530.65	Brushed Gold	12
		UT2192EPBL	571.15	Matte Black	12
					
 <ul style="list-style-type: none"> • showerhead sold separately • red/blue markings: included • includes: pressure balanced cartridge with temperature control • valve: sold separately 		UT2192NH	303.00	Chrome	3
		UT2192NHBN	447.45	Brushed Nickel	3
		UT2192NHBG	447.45	Brushed Gold	3
		UT2192NHBL	479.65	Matte Black	3
					
RIZON® M-CORE® 2-SERIES SHOWER ONLY TRIM					
 <ul style="list-style-type: none"> • showerhead: single-function eco-performance • showerhead size: 3.75" diameter • red/blue markings: included • includes: pressure balanced cartridge with temperature control • valve: sold separately 		1.75 GPM (6.65 L/min) max.			
		UT2812EP	348.50	Chrome	12
		UT2812EPBL	571.10	Matte Black	12
					
 <ul style="list-style-type: none"> • showerhead sold separately • red/blue markings: included • includes: pressure balanced cartridge with temperature control • valve: sold separately 		UT2812NH	303.00	Chrome	3
		UT2812NHBL	479.65	Matte Black	3
					
BELFIELD™ M-CORE® 2-SERIES SHOWER ONLY TRIM					
 <ul style="list-style-type: none"> • showerhead: single-function eco-performance rainshower • showerhead size: 7" diameter • includes: pressure balanced cartridge with temperature control • valve: sold separately 		1.75 GPM (6.65 L/min) max.			
		UT2312EP	340.45	Chrome	4
		UT2312EPBN	515.95	Brushed Nickel	4
		UT2312EPNL	515.95	Polished Nickel	4
		UT2312EPBL	527.70	Matte Black	4
		UT2312EPORB	554.75	Oil Rubbed Bronze	4
					
		Q3 NEW!			
CIA™ M-CORE® 2-SERIES SHOWER ONLY TRIM					
 <ul style="list-style-type: none"> • showerhead: single-function eco-performance rainshower • showerhead size: 6-3/4" diameter • red/blue markings: included • includes: pressure balanced cartridge with temperature control • valve: sold separately 		1.75 GPM (6.65 L/min) max.			
		UT2262EP	334.50	Chrome	4
		UT2262EPBN	509.30	Brushed Nickel	4
		UT2262EPBG	509.30	Brushed Gold	4
		UT2262EPBL	548.15	Matte Black	4
					
VOSS™ M-CORE® 2-SERIES SHOWER ONLY TRIM					
 <ul style="list-style-type: none"> • showerhead: single-function eco-performance • showerhead size: 4-1/16" diameter • includes: pressure balanced cartridge with temperature control • valve: sold separately 		1.75 GPM (6.65 L/min) max.			
		UT2692EP	334.50	Chrome	12
		UT2692EPBN	509.30	Brushed Nickel	12
		UT2692EPNL	509.30	Polished Nickel	12
		UT2692EPBG	509.30	Brushed Gold	12
		UT2692EPORB	548.05	Oil Rubbed Bronze	12
					
DARTMOOR™ M-CORE® 2-SERIES SHOWER ONLY TRIM					
 <ul style="list-style-type: none"> • showerhead: single-function eco-performance rainshower • showerhead size: 8" diameter • includes: pressure balanced cartridge with temperature control • valve: sold separately 		1.75 GPM (6.65 L/min) max.			
		UT2282EP	265.45	Chrome	4
		UT2282EPBN	370.60	Brushed Nickel	4
		UT2282EPBL	390.10	Matte Black	4
		UT2282EPORB	390.10	Oil Rubbed Bronze	4
					
 <ul style="list-style-type: none"> • showerhead: single-function eco-performance • showerhead size: 4" diameter • includes: pressure balanced cartridge with temperature control • valve: sold separately 		1.75 GPM (6.65 L/min) max.			
		UT2182EP	186.55	Chrome	12
		UT2182EPBN	321.00	Brushed Nickel	12
		UT2182EPBL	341.00	Matte Black	12
		UT2182EPORB	341.00	Oil Rubbed Bronze	12
					





































CUSTOM SHOWERING

M-CORE® 2-Series Shower Only Shower Options

CUSTOM SHOWERING

		MODEL	LIST	FINISH/CONNECT	CASE QTY
GLYDE™ M-CORE® 2-SERIES SHOWER ONLY TRIM					
 	<ul style="list-style-type: none"> • showerhead: single-function eco-performance rainshower • showerhead size: 8" diameter • includes: pressure balanced cartridge with temperature control • valve: sold separately  	1.75 GPM (6.65 L/min) max.			
		UT2842EP	265.45	Chrome	4
		UT2842EPBN	370.60	Brushed Nickel	4
		UT2842EPBL	390.10	Matte Black	4
 	<ul style="list-style-type: none"> • showerhead: single-function eco-performance • showerhead size: 3-3/4" diameter • includes: pressure balanced cartridge with temperature control • valve: sold separately  	1.75 GPM (6.65 L/min) max.			
		UT2742EP	186.55	Chrome	12
		UT2742EPBN	321.00	Brushed Nickel	12
		UT2742EPBL	341.00	Matte Black	12
BRANTFORD® M-CORE® 2-SERIES SHOWER ONLY TRIM					
 	<ul style="list-style-type: none"> • showerhead: single-function eco-performance rainshower • showerhead size: 8" diameter • includes: pressure balanced cartridge with temperature control • valve: sold separately  	1.75 GPM (6.65 L/min) max.			
		UT2252EP	265.45	Chrome	4
		UT2252EPBN	370.60	Brushed Nickel	4
		UT2252EPORB	390.10	Oil Rubbed Bronze	4
 	<ul style="list-style-type: none"> • showerhead: single-function eco-performance • showerhead size: 3-1/2" diameter • includes: pressure balanced cartridge with temperature control • valve: sold separately  	1.75 GPM (6.65 L/min) max.			
		UT2152EP	186.55	Chrome	12
		UT2152EPBN	321.00	Brushed Nickel	12
		UT2152EPORB	341.00	Oil Rubbed Bronze	12
 	<ul style="list-style-type: none"> • showerhead sold separately • includes: pressure balanced cartridge with temperature control • valve: sold separately  	UT2152NH	182.60	Chrome	3
		UT2152NHBN	292.40	Brushed Nickel	3
		UT2152NHORB	309.60	Oil Rubbed Bronze	3
EVA® M-CORE® 2-SERIES SHOWER ONLY TRIM					
 	<ul style="list-style-type: none"> • showerhead: single-function eco-performance rainshower • showerhead size: 8" diameter • includes: pressure balanced cartridge with temperature control • valve: sold separately  	1.75 GPM (6.65 L/min) max.			
		UT2232EP	265.45	Chrome	4
		UT2232EPBN	370.60	Brushed Nickel	4
		UT2232EPORB	390.10	Oil Rubbed Bronze	4
 	<ul style="list-style-type: none"> • showerhead: single-function eco-performance • showerhead size: 3-1/2" diameter • includes: pressure balanced cartridge with temperature control • valve: sold separately  	1.75 GPM (6.65 L/min) max.			
		UT2132EP	186.55	Chrome	12
		UT2132EPBN	321.00	Brushed Nickel	12
		UT2132EPORB	341.00	Oil Rubbed Bronze	12
 	<ul style="list-style-type: none"> • showerhead sold separately • includes: pressure balanced cartridge with temperature control • valve: sold separately  	UT2132NH	182.60	Chrome	3
		UT2132NHBN	292.40	Brushed Nickel	3
		UT2132NHORB	309.60	Oil Rubbed Bronze	3













M-CORE® 2-Series Shower Only Shower Options

		MODEL	LIST	FINISH/CONNECT	CASE QTY
VICHY™ M-CORE® 2-SERIES SHOWER ONLY TRIM					
	<ul style="list-style-type: none"> • showerhead: single-function eco-performance • showerhead size: 3.75" diameter • red/blue markings: included • includes: pressure balanced cartridge with temperature control • valve: sold separately  	1.75 GPM (6.65 L/min) max.			
		UT2662EP	195.95	Chrome	1
	<ul style="list-style-type: none"> • showerhead sold separately • red/blue markings: included • includes: pressure balanced cartridge with temperature control • valve: sold separately  	UT2662NH	192.20	Chrome	3
					
GIBSON™ M-CORE® 2-SERIES SHOWER ONLY TRIM					
	<ul style="list-style-type: none"> • showerhead: single-function eco-performance rainshower • showerhead size: 8" diameter • red/blue markings: included • includes: pressure balanced cartridge with temperature control • valve: sold separately  	1.75 GPM (6.65 L/min) max.			
		UT3002EP	249.80	Chrome	4
		UT3002EPBN	350.60	Brushed Nickel	4
		UT3002EPBL	373.55	Matte Black	4
	<ul style="list-style-type: none"> • showerhead: single-function eco-performance • showerhead size: 3.6" diameter • red/blue markings: included • includes: pressure balanced cartridge with temperature control • valve: sold separately  	1.75 GPM (6.65 L/min) max.			
		UT2902EP	195.95	Chrome	12
		UT2902EPBN	275.85	Brushed Nickel	12
		UT2902EPBL	291.45	Matte Black	12
	<ul style="list-style-type: none"> • showerhead sold separately • red/blue markings: included • includes: pressure balanced cartridge with temperature control • valve: sold separately  	UT2902NH	192.20	Chrome	3
		UT2902NHBN	268.25	Brushed Nickel	3
		UT2902NHBL	283.10	Matte Black	3
GENTA™ LX M-CORE® 2-SERIES SHOWER ONLY TRIM					
	<ul style="list-style-type: none"> • showerhead: six-function eco-performance • showerhead size: 4.5" diameter • red/blue markings: included • includes: pressure balanced cartridge with temperature control • valve: sold separately  	1.75 GPM (6.65 L/min) max.			
		UT2472EP	192.80	Chrome	12
		UT2472EPBN	269.00	Brushed Nickel	12
		UT2472EPBL	283.90	Matte Black	12
	<ul style="list-style-type: none"> • showerhead sold separately • red/blue markings: included • includes: pressure balanced cartridge with temperature control • valve: sold separately  	UT2472NH	189.20	Chrome	3
		UT2472NHBN	261.70	Brushed Nickel	3
		UT2472NHBL	275.80	Matte Black	3
CHATEAU® M-CORE® 2-SERIES SHOWER ONLY TRIM					
	<ul style="list-style-type: none"> • showerhead: single-function eco-performance • showerhead size: 2-1/2" diameter • red/blue markings: included • includes: pressure balanced cartridge with temperature control • valve: sold separately  	1.75 GPM (6.65 L/min) max.			
		UTL182EP	157.75	Chrome	12
	<ul style="list-style-type: none"> • showerhead sold separately • red/blue markings: included • includes: pressure balanced cartridge with temperature control • valve: sold separately  	UTL182NH	155.15	Chrome	12
					













CUSTOM SHOWERING

Posi-Temp® Shower Only Shower Options

CUSTOM SHOWERING

		MODEL	LIST	FINISH/CONNECT	CASE QTY
	POSI-TEMP® SHOWER ONLY TRIM - PREMIUM • showerhead: two-function rainshower • showerhead size: 9" diameter • valve: sold separately 	2.5 GPM (9.5 L/min) max.			
		TS32102	766.85	Chrome	3
		TS32102BN	1119.30	Brushed Nickel	3
		TS32102NL	1119.30	Polished Nickel	3
		TS32102BG	1119.30	Brushed Gold	3
		TS32102BL	1207.45	Matte Black	3
		TS32102ORB	1207.45	Oil Rubbed Bronze	3
		1.75 GPM (6.65 L/min) max.			
		TS32102EP	766.85	Chrome	3
		TS32102EPBN	1119.30	Brushed Nickel	3
		TS32102EPNL	1119.30	Polished Nickel	3
		TS32102EPBG	1119.30	Brushed Gold	3
		TS32102EPBL	1207.45	Matte Black	3
		TS32102EPORB	1207.45	Oil Rubbed Bronze	3
			POSI-TEMP® SHOWER ONLY TRIM - PREMIUM • showerhead: single-function rainshower • showerhead size: 10" diameter • valve: sold separately 	2.5 GPM (9.5 L/min) max.	
TS22002	728.30			Chrome	3
TS22002BL	1170.00			Matte Black	3
1.75 GPM (6.65 L/min) max.					
TS22002EP	728.30			Chrome	3
TS22002EPBL	1170.00	Matte Black	3		
	POSI-TEMP® SHOWER ONLY TRIM - PREMIUM • showerhead: single-function rainshower • showerhead size: 6" diameter • valve: sold separately 	2.5 GPM (9.5 L/min) max.			
		TS2912	434.15	Chrome	4
		TS2912BN	651.15	Brushed Nickel	4
		TS2912NL	651.15	Polished Nickel	4
		TS2912BG	651.15	Brushed Gold	4
		1.75 GPM (6.65 L/min) max.			
		TS2912EP	434.15	Chrome	4
TS2912EPBN	651.15	Brushed Nickel	4		
TS2912EPNL	651.15	Polished Nickel	4		
TS2912EPBG	651.15	Brushed Gold	4		
	POSI-TEMP® SHOWER ONLY TRIM - PREMIUM • showerhead: single-function rainshower • showerhead size: 6" diameter • valve: sold separately 	2.5 GPM (9.5 L/min) max.			
		TS2712	315.25	Chrome	3
		TS2712BN	583.85	Brushed Nickel	3
		Q3 NEW! TS2712BL	598.95	Matte Black	3
		1.75 GPM (6.65 L/min) max.			
		TS2712EP	315.25	Chrome	3
		Q3 NEW! TS2712EPBN	583.85	Brushed Nickel	3
Q3 NEW! TS2712EPBL	598.95	Matte Black	3		
	POSI-TEMP® SHOWER ONLY TRIM - PREMIUM • showerhead: single-function rainshower • showerhead size: 6-3/4" diameter • valve: sold separately 	2.5 GPM (9.5 L/min) max.			
		TS2202	333.55	Chrome	4
		TS2202BN	483.60	Brushed Nickel	4
		TS2202BL	532.05	Matte Black	4
		1.75 GPM (6.65 L/min) max.			
		TS2202EP	333.55	Chrome	4
TS2202EPBN	483.60	Brushed Nickel	4		
TS2202EPBL	532.05	Matte Black	4		
	POSI-TEMP® SHOWER ONLY TRIM • showerhead: single-function eco-performance rainshower • showerhead size: 3-5/8" diameter • valve: sold separately 	1.75 GPM (6.65 L/min) max.			
		T2222EP	222.40	Chrome	12
		T2222EPBN	404.50	Brushed Nickel	12
		T2222EPBG	404.50	Brushed Gold	12
		T2222EPBL	445.05	Matte Black	12















Posi-Temp® Shower Only Shower Options

		MODEL	LIST	FINISH/CONNECT	CASE QTY	
WYNFORD® POSI-TEMP® SHOWER ONLY TRIM						
 <ul style="list-style-type: none"> • showerhead: single-function standard • showerhead size: 5-7/8" diameter • valve: sold separately 	2.5 GPM (9.5 L/min) max.					
		T4502	222.40	Chrome	3	
		T4502BN	404.50	Brushed Nickel	3	
		T4502ORB	444.90	Oil Rubbed Bronze	3	
	1.75 GPM (6.65 L/min) max.					
		T4502EP	222.40	Chrome	3	
		T4502EPBN	404.50	Brushed Nickel	3	
		T4502EORB	444.90	Oil Rubbed Bronze	3	
	ALIGN® POSI-TEMP® SHOWER ONLY TRIM					
	 <ul style="list-style-type: none"> • showerhead: single-function standard • showerhead size: 3-5/8" diameter • red/blue markings: included • valve: sold separately 	2.5 GPM (9.5 L/min) max.				
		T2192	222.40	Chrome	3	
		T2192BN	404.50	Brushed Nickel	3	
		T2192BG	404.50	Brushed Gold	3	
		T2192BL	445.05	Matte Black	3	
1.75 GPM (6.65 L/min) max.						
		T2192EP	222.40	Chrome	3	
		T2192EPBN	404.50	Brushed Nickel	3	
		T2192EPBG	404.50	Brushed Gold	3	
		T2192EPBL	445.05	Matte Black	3	
 <ul style="list-style-type: none"> • showerhead sold separately • red/blue markings: included • valve: sold separately 		T2192NH	176.95	Chrome	3	
		T2192NHBN	321.35	Brushed Nickel	3	
		T2192NHBG	321.35	Brushed Gold	3	
		T2192NHBL	353.50	Matte Black	3	
	RIZON® POSI-TEMP® SHOWER ONLY TRIM					
	 <ul style="list-style-type: none"> • showerhead: single-function standard • showerhead size: 3.75" diameter • red/blue markings: included • valve: sold separately 	2.5 GPM (9.5 L/min) max.				
		T2812	222.40	Chrome	3	
		T2812BL	445.00	Matte Black	3	
1.75 GPM (6.65 L/min) max.						
		T2812EP	222.40	Chrome	3	
		T2812EPBL	445.00	Matte Black	3	
 <ul style="list-style-type: none"> • showerhead sold separately • red/blue markings: included • valve: sold separately 		T2812NH	176.95	Chrome	3	
		T2812NHBL	353.50	Matte Black	3	
	BELFIELD™ POSI-TEMP® SHOWER ONLY TRIM					
 <ul style="list-style-type: none"> • showerhead: single-function rainshower • showerhead size: 7" diameter • valve: sold separately  	2.5 GPM (9.5 L/min) max.					
		T2312	214.30	Chrome	4	
		T2312BN	389.80	Brushed Nickel	4	
		T2312NL	389.80	Polished Nickel	4	
		T2312BL	396.45	Matte Black	4	
		T2312ORB	428.60	Oil Rubbed Bronze	4	
	1.75 GPM (6.65 L/min) max.					
		T2312EP	214.30	Chrome	4	
		T2312EPBN	389.80	Brushed Nickel	4	
		T2312EPNL	389.80	Polished Nickel	4	
	T2312EPBL	396.45	Matte Black	4		
	T2312EORB	428.60	Oil Rubbed Bronze	4		

CUSTOM SHOWERING

Posi-Temp® Shower Only Shower Options

CUSTOM SHOWERING















		MODEL	LIST	FINISH/CONNECT	CASE QTY
CIA™	POSI-TEMP® SHOWER ONLY TRIM				
 <ul style="list-style-type: none"> • showerhead: single-function eco-performance rainshower • showerhead size: 6-3/4" diameter • red/blue markings: included • valve: sold separately 		1.75 GPM (6.65 L/min) max.			
		T2262EP	213.45	Chrome	4
		T2262EPBN	388.25	Brushed Nickel	4
		T2262EPBG	388.25	Brushed Gold	4
		T2262EPBL	427.10	Matte Black	4
VOSS™	POSI-TEMP® SHOWER ONLY TRIM				
 <ul style="list-style-type: none"> • showerhead: single-function standard • showerhead size: 4-1/16" diameter • valve: sold separately 		2.5 GPM (9.5 L/min) max.			
		T2692	213.45	Chrome	3
		T2692BN	388.25	Brushed Nickel	3
		T2692NL	388.25	Polished Nickel	3
		T2692BG	388.25	Brushed Gold	3
		Q3 NEW! T2692BL	394.85	Matte Black	3
		T2692ORB	427.00	Oil Rubbed Bronze	3
		1.75 GPM (6.65 L/min) max.			
		T2692EP	213.45	Chrome	3
		T2692EPBN	388.25	Brushed Nickel	3
		T2692EPNL	388.25	Polished Nickel	3
		T2692EPBG	388.25	Brushed Gold	3
		Q3 NEW! T2692EPBL	394.85	Matte Black	3
		T2692EPORB	427.00	Oil Rubbed Bronze	3
 <ul style="list-style-type: none"> • showerhead sold separately • valve: sold separately 		T2692NH	169.80	Chrome	3
		T2692NHBN	308.40	Brushed Nickel	3
DARTMOOR™	POSI-TEMP® SHOWER ONLY TRIM				
 <ul style="list-style-type: none"> • showerhead: single-function eco-performance rainshower • showerhead size: 8" diameter • valve: sold separately 		1.75 GPM (6.65 L/min) max.			
		T2282EP	145.25	Chrome	4
		T2282EPBN	250.45	Brushed Nickel	4
		T2282EPBL	270.00	Matte Black	4
		T2282EPORB	270.00	Oil Rubbed Bronze	4
 <ul style="list-style-type: none"> • showerhead: single-function standard • showerhead size: 4" diameter • valve: sold separately 		2.5 GPM (9.5 L/min) max.			
		T2182	93.35	Chrome	3
		T2182BN	200.85	Brushed Nickel	3
		T2182BL	220.85	Matte Black	3
		T2182ORB	220.85	Oil Rubbed Bronze	3
		1.75 GPM (6.65 L/min) max.			
		T2182EP	77.40	Chrome	3
		T2182EPBN	200.85	Brushed Nickel	3
		T2182EPBL	220.85	Matte Black	3
		T2182EPORB	220.85	Oil Rubbed Bronze	3
GLYDE™	POSI-TEMP® SHOWER ONLY TRIM				
 <ul style="list-style-type: none"> • showerhead: single-function eco-performance rainshower • showerhead size: 8" diameter • valve: sold separately 		1.75 GPM (6.65 L/min) max.			
		T2842EP	145.25	Chrome	4
		T2842EPBN	250.45	Brushed Nickel	4
		T2842EPBL	270.00	Matte Black	4
 <ul style="list-style-type: none"> • showerhead: single-function standard • showerhead size: 3-3/4" diameter • valve: sold separately 		2.5 GPM (9.5 L/min) max.			
		T2742	93.35	Chrome	3
		T2742BN	200.85	Brushed Nickel	3
		T2742BL	220.85	Matte Black	3
		1.75 GPM (6.65 L/min) max.			
		T2742EP	77.40	Chrome	3
		T2742EPBN	200.85	Brushed Nickel	3
T2742EPBL	220.85	Matte Black	3		

Posi-Temp® Shower Only Shower Options

		MODEL	LIST	FINISH/CONNECT	CASE QTY
BRANTFORD® POSI-TEMP® SHOWER ONLY TRIM					
	<ul style="list-style-type: none"> showerhead: single-function eco-performance rainshower showerhead size: 8" diameter valve: sold separately 	1.75 GPM (6.65 L/min) max.			
		T2252EP	145.25	Chrome	4
		T2252EPBN	250.45	Brushed Nickel	4
		T2252EPORB	270.00	Oil Rubbed Bronze	4
2.5 GPM (9.5 L/min) max.					
	<ul style="list-style-type: none"> showerhead: single-function standard showerhead size: 3-1/2" diameter valve: sold separately 	T2152	93.35	Chrome	3
		T2152BN	200.85	Brushed Nickel	3
		T2152ORB	220.85	Oil Rubbed Bronze	3
1.75 GPM (6.65 L/min) max.					
	<ul style="list-style-type: none"> showerhead: single-function eco-performance showerhead size: 3-1/2" diameter chrome sold in case qty only: no single pack valve: sold separately 	T62152EP	77.40	Chrome	12
		T2152EPBN	200.85	Brushed Nickel	3
		T2152EPORB	220.85	Oil Rubbed Bronze	3
EVA® POSI-TEMP® SHOWER ONLY TRIM					
	<ul style="list-style-type: none"> showerhead: single-function eco-performance rainshower showerhead size: 8" diameter valve: sold separately 	1.75 GPM (6.65 L/min) max.			
		T2232EP	145.25	Chrome	4
		T2232EPBN	250.45	Brushed Nickel	4
		T2232EPORB	270.00	Oil Rubbed Bronze	4
2.5 GPM (9.5 L/min) max.					
	<ul style="list-style-type: none"> showerhead: single-function standard showerhead size: 3-1/2" diameter valve: sold separately 	T2132	93.35	Chrome	3
		T2132BN	200.85	Brushed Nickel	3
		T2132ORB	220.85	Oil Rubbed Bronze	3
2.5 GPM (9.5 L/min) max.					
	<ul style="list-style-type: none"> showerhead: five-function standard showerhead size: 4" diameter used to replace: 2 or 3 hole shower valve valve: sold separately 	T2138	145.25	Chrome	3
		T2138BN	250.45	Brushed Nickel	3
1.75 GPM (6.65 L/min) max.					
	<ul style="list-style-type: none"> showerhead: single-function eco-performance showerhead size: 3-1/2" diameter chrome sold in case qty only: no single pack valve: sold separately 	T62132EP	77.40	Chrome	12
		T2132EPBN	200.85	Brushed Nickel	3
		T2132EPORB	220.85	Oil Rubbed Bronze	3
VICHY™ POSI-TEMP® SHOWER ONLY TRIM					
	<ul style="list-style-type: none"> showerhead: single-function eco-performance showerhead size: 3.75" diameter red/blue markings: included valve: sold separately 	1.75 GPM (6.65 L/min) max.			
		T2662EP	75.75	Chrome	3

CUSTOM SHOWERING

Posi-Temp® Shower Only Shower Options

		MODEL	LIST	FINISH/CONNECT	CASE QTY
GIBSON™ POSI-TEMP® SHOWER ONLY TRIM					
 <ul style="list-style-type: none"> • showerhead: single-function eco-performance rainshower • showerhead size: 8" diameter • red/blue markings: included • valve: sold separately 		1.75 GPM (6.65 L/min) max.			
		T3002EP	129.75	Chrome	4
		T3002EPBN	230.40	Brushed Nickel	4
		T3002EPBL	253.45	Matte Black	4
 <ul style="list-style-type: none"> • showerhead: single-function eco-performance • showerhead size: 3.6" diameter • red/blue markings: included • valve: sold separately 		1.75 GPM (6.65 L/min) max.			
		T2902EP	75.75	Chrome	3
		T2902EPBN	155.75	Brushed Nickel	3
		T2902EPBL	171.35	Matte Black	3
 <ul style="list-style-type: none"> • showerhead sold separately • red/blue markings: included • valve: sold separately 		T2902NH	72.05	Chrome	3
		T2902NHBN	148.10	Brushed Nickel	3
		T2902NHBL	162.90	Matte Black	3
GENTA™ LX POSI-TEMP® SHOWER ONLY TRIM					
 <ul style="list-style-type: none"> • showerhead: six-function eco-performance • showerhead size: 4.5" diameter • red/blue markings: included • valve: sold separately 		1.75 GPM (6.65 L/min) max.			
		T2472EP	72.65	Chrome	3
		T2472EPBN	148.85	Brushed Nickel	3
		T2472EPBL	163.80	Matte Black	3
 <ul style="list-style-type: none"> • showerhead sold separately • red/blue markings: included • valve: sold separately 		T2472NH	69.00	Chrome	3
		T2472NHBN	141.50	Brushed Nickel	3
		T2472NHBL	155.65	Matte Black	3
CHATEAU® POSI-TEMP® SHOWER ONLY TRIM					
 <ul style="list-style-type: none"> • showerhead: single-function standard • showerhead size: 2-1/2" diameter • red/blue markings: included • valve: sold separately 		2.5 GPM (9.5 L/min) max.			
		TL182	49.05	Chrome	12
		1.75 GPM (6.65 L/min) max.			
		TL182EP	49.05	Chrome	12
 <ul style="list-style-type: none"> • showerhead: single-function eco-performance • showerhead size: 2-1/2" diameter • used to replace: 2 or 3 hole shower valve • valve: sold separately 		1.75 GPM (6.65 L/min) max.			
		TL2368EP	103.40	Chrome	6

M-CORE® 4-Series, 3-Series and 2-Series Shower Spa Shower Rail Showering Configurations

Moen has all the components necessary for you to build a custom shower spa. And, we're making it easy for you to pull together the sku numbers you need. Charts of common shower spa configurations are included so that all the components can be ordered. The charts below illustrate one layout and option of showering components. Refer to pages 429 - 460 in the Custom Showering section to choose from our wide array of showering products, styles and finishes to meet your preference. For additional assistance, call your Moen Sales Representative.



M-CORE® 4-SERIES, 3-SERIES OR 2-SERIES WITH MOEN SPA SHOWER RAIL & HANDSHOWER COMBO



1 discrete and 1 shared function
Moen Spa Shower Rail & Align® suites shown.
*mixing valve shows M-CORE 3-Series trim

M-CORE® 4-SERIES 3-SERIES OR 2-SERIES WITH MOEN SPA SHOWER RAIL



1 discrete function
Moen Spa Shower Rail & Align® suites shown.
*mixing valve shows M-CORE 3-Series trim

Suite	M-CORE Valve Only Trim PICK YOUR MIXING VALVE TRIM			Moen Spa Shower Rail & Handshower Combo
	4-Series	3-Series	2-Series	
Weymouth®	UTS43101	UTS33101	UTS232102EP	N207C0
Arris®	UTS42001	UTS32001	UTS22001	N207C0
Flara™	UTS4910	UTS3911	UTS2911	N207C0
Colinet™	UTS444301	UTS344301	UTS244201	N207C0
90°®	UTS4711	UTS3711	UTS2711	N207C0
Doux™	UTS4201	UTS3201	UTS2201	N207C0
Greenfield™	UT4321	UT33321	UT2321	N207C0
Wynford®	UT45501	UT35501	UT24501	N207C0
Align®	UT4291	UT3291	UT2191	N207C0
Rizon®			UT2811	N207C0
Belfield™	UT4311	UT3311	UT2311	N207C0
Cia™	UT4361	UT3362	UT2261	N207C0
Voss™	UT4691	UT3691	UT2691	N207C0
Dartmoor®			UT2181	N207C0
Glyde™			UT2741	N207C0
Brantford®			UT2151	N207C0
Eva®			UT2131	N207C0
Gibson™			UT2901	N207C0
Genta™ LX			UT2471	N207C0

Use M-CORE valve U130, sold separately
Reference valve section for details

NOTE: only the Moen Spa Shower Rail handshower can be used with the Moen Spa Shower rail

Suite	M-CORE Valve Only Trim PICK YOUR MIXING VALVE TRIM			Moen Spa Shower Rail
	4-Series	3-Series	2-Series	
Weymouth®	UTS43101	UTS33101	UTS232102EP	N207R0
Arris®	UTS42001	UTS32001	UTS22001	N207R0
Flara™	UTS4910	UTS3911	UTS2911	N207R0
Colinet™	UTS444301	UTS344301	UTS244201	N207R0
90°®	UTS4711	UTS3711	UTS2711	N207R0
Doux™	UTS4201	UTS3201	UTS2201	N207R0
Greenfield™	UT4321	UT33321	UT2321	N207R0
Wynford®	UT45501	UT35501	UT24501	N207R0
Align®	UT4291	UT3291	UT2191	N207R0
Rizon®			UT2811	N207R0
Belfield™	UT4311	UT3311	UT2311	N207R0
Cia™	UT4361	UT3362	UT2261	N207R0
Voss™	UT4691	UT3691	UT2691	N207R0
Dartmoor®			UT2181	N207R0
Glyde™			UT2741	N207R0
Brantford®			UT2151	N207R0
Eva®			UT2131	N207R0
Gibson™			UT2901	N207R0
Genta™ LX			UT2471	N207R0

Use M-CORE valve U130, sold separately
Reference valve section for details

M-CORE Mixing Valve	Flow Rate through shower port (GPM) @ 20 PSI	Flow Rate through shower port (GPM) @ 40 PSI	Flow Rate through shower port (GPM) @ 60 PSI
M-CORE U130	3.1	4.6	5.8

POSI-TEMP® Shower Spa with Moen Spa Shower Rail Showering Components

Moen has all the components necessary for you to build a custom shower spa. And, we're making it easy for you to pull together the sku numbers you need. Charts of common shower spa configurations are included so that all the components can be ordered. The charts below illustrate one layout and option of showering components. Refer to pages 429 - 460 in the Custom Showering section to choose from our wide array of showering products, styles and finishes to meet your preference. For additional assistance, call your Moen Sales Representative.



POSI-TEMP® WITH MOEN SPA SHOWER RAIL & HANDSHOWER COMBO



1 discrete and
1 shared function

Moen Spa
Shower Rail &
Align® suites
shown.

Suite	Posi-Temp® Valve Only Trim	Moen Spa Shower Rail & Handshower Combo
Weymouth®	TS32102	N207C0
Arris®	TS22001	N207C0
Flara™	TS2911	N207C0
Colinet™	TS44201	N207C0
90°®	TS2711	N207C0
Doux™	TS2201	N207C0
Greenfield™	T2221	N207C0
Wynford®	T4501	N207C0
Align®	T2191	N207C0
Rizon®	T2811	N207C0
Belfield™	T2311	N207C0
Cia™	T2261	N207C0
Voss™	T2691	N207C0
Dartmoor®	T2181	N207C0
Glyde™	T2741	N207C0
Brantford®	T2151	N207C0
Eva®	T2131	N207C0
Gibson™	T2901	N207C0
Genta™ LX	T2471	N207C0
Chateau®	TL181	N207C0

Use Posi-Temp® valve 2520

Reference valve section for details

NOTE: only the Moen Spa Shower Rail handshower can be used with the Moen Spa shower rail

POSI-TEMP® WITH MOEN SPA SHOWER RAIL



1 discrete
function

Moen Spa
Shower Rail &
Align® suites
shown.

Suite	Posi-Temp® Valve Only Trim	Moen Spa Shower Rail
Weymouth®	TS32102	N207R0
Arris®	TS22001	N207R0
Flara™	TS2911	N207R0
Colinet™	TS44201	N207R0
90°®	TS2711	N207R0
Doux™	TS2201	N207R0
Greenfield™	T2221	N207R0
Wynford®	T4501	N207R0
Align®	T2191	N207R0
Rizon®	T2811	N207R0
Belfield™	T2311	N207R0
Cia™	T2261	N207R0
Voss™	T2691	N207R0
Dartmoor®	T2181	N207R0
Glyde™	T2741	N207R0
Brantford®	T2151	N207R0
Eva®	T2131	N207R0
Gibson™	T2901	N207R0
Genta™ LX	T2471	N207R0
Chateau®	TL181	N207R0

Use Posi-Temp® valve 2520

Reference valve section for details

M-CORE® 4-Series, 3-Series and 2-Series Shower Spa with Annex™ Shower Rail Showering Configurations

Moen has all the components necessary for you to build a custom shower spa. And, we're making it easy for you to pull together the sku numbers you need. Charts of common shower spa configurations are included so that all the components can be ordered. The charts below illustrate one layout and option of showering components. Refer to pages 429 - 460 in the Custom Showering section to choose from our wide array of showering products, styles and finishes to meet your preference. For additional assistance, call your Moen Sales Representative.



M-CORE® 4-SERIES, 3-SERIES OR 2-SERIES WITH ANNEX™ SHOWER RAIL & HANDSHOWER



2 discrete functions
Annex™ & Flara™ suite shown.

*mixing valve shows M-CORE 3-Series trim

Suite	M-CORE Valve Only Trim PICK YOUR MIXING VALVE TRIM			Showerhead	Shower Arm Optional	Annex™ Shower Rail	Handshower
	4-Series	3-Series	2-Series				
Weymouth®	UTS43101	UTS33101	UTS232102EP	S1311	S113	TS3661NH	154305
Arris®	UTS42001	UTS32001	UTS22001	S112	S110	TS3661NH	155891
Flara™	UTS4910	UTS3911	UTS2911	S6365		TS3661NH	S3880EP
Colinet™	UTS444301	UTS344301	UTS244201	S112		TS3661NH	3887EP
90°®	UTS4711	UTS3711	UTS2711	S6340		TS3661NH	189575
Doux™	UTS4201	UTS3201	UTS2201	S176		TS3661NH	155891
Greenfield™	UT4321	UT33321	UT2321	S178		TS3661NH	155891
Wynford®	UT45501	UT35501	UT24501	S6310		TS3661NH	164927
Align®	UT4291	UT3291	UT2191	S176	161951	TS3661NH	155891
Rizon®			UT2811	6345		TS3661NH	189318
Belfield™	UT4311	UT3311	UT2311	S6310		TS3661NH	164927
Cia™	UT4361	UT3362	UT2261	S112		TS3661NH	189575
Voss™	UT4691	UT3691	UT2691	S6365	161951	TS3661NH	189318
Dartmoor®			UT2181	6345		TS3661NH	164927
Glyde™			UT2741	6345		TS3661NH	155891
Brantford®			UT2151	6345		TS3661NH	164927
Eva®			UT2131	6345		TS3661NH	164929
Gibson™			UT2901	6345		TS3661NH	164929
Genta™ LX			UT2471	6345		TS3661NH	189318

Use M-CORE valve U130, sold separately
Reference valve section for details

M-CORE Mixing Valve	Flow Rate through shower port (GPM) @ 20 PSI	Flow Rate through shower port (GPM) @ 40 PSI	Flow Rate through shower port (GPM) @ 60 PSI
M-CORE U130	3.1	4.6	5.8

Posi-Temp® Shower Spa with Annex™ Shower Rail Showering Configurations

Moen has all the components necessary for you to build a custom shower spa. And, we're making it easy for you to pull together the sku numbers you need. Charts of common shower spa configurations are included so that all the components can be ordered. The charts below illustrate one layout and option of showering components. Refer to pages 429 - 460 in the Custom Showering section to choose from our wide array of showering products, styles and finishes to meet your preference. For additional assistance, call your Moen Sales Representative.



POSI-TEMP® SHOWER SPA WITH ANNEX™ SHOWER RAIL





Annex™ & Flara™ suite shown.

Suite	Posi-Temp® Valve Only Trim	Showerhead	Shower Arm Optional	Annex™ Shower Rail	Handshower
Weymouth®	TS32102	S1311	S113	TS3661NH	154305
Arris®	TS22001	S112	S110	TS3661NH	155891
Flara™	TS2911	S6365		TS3661NH	S3880EP
Colinet™	TS44201	S112	151380	TS3661NH	3887EP
90°®	TS2711	S6340		TS3661NH	189575
Doux™	TS2201	S176		TS3661NH	155891
Greenfield™	T2221	S178		TS3661NH	155891
Wynford®	T4501	S6310		TS3661NH	164927
Align®	T2191	S176	161951	TS3661NH	155891
Rizon®	T2811	6345		TS3661NH	189318
Belfield™	T2311	S6310		TS3661NH	164927
Cia™	T2261	S112		TS3661NH	189575
Voss™	T2691	S6365	161951	TS3661NH	189318
Dartmoor®	T2181	6345		TS3661NH	164927
Glyde™	T2741	6345		TS3661NH	155891
Brantford®	T2151	6345		TS3661NH	164927
Eva®	T2131	6345		TS3661NH	164929
Gibson™	T2901	6345		TS3661NH	164929
Genta™ LX	T2471	6345		TS3661NH	189318
Chateau®	TL181	6345		TS3661NH	164929

Use Posi-Temp® valve 2520, sold separately
Reference valve section for details

Shower Rails











		MODEL	LIST	FINISH/CONNECT	CASE QTY
	MOEN SPA SHOWER RAIL COMBO - PREMIUM <ul style="list-style-type: none"> • connection: 1/2" IPS • showerhead: two-function standard with handshower • showerhead size: 7-3/4" diameter • type of function: atomized spray • includes: double check valves for backflow prevention • 23-1/2" wall bracket with 17" height range 	1.75 GPM (6.65 L/min) max.			
		N207C0CH	482.40	Chrome/White	2
		N207C0SRN	559.05	Spot Resist Brushed Nickel	2
		N207C0BLC	575.90	Matte Black/Chrome	2
		N207C0BL	669.35	Matte Black	2
	MOEN SPA SHOWER RAIL - PREMIUM <ul style="list-style-type: none"> • connection: 1/2" IPS • showerhead: single-function rainshower • showerhead size: 7-3/4" diameter • type of function: atomized spray • included: double check valves for backflow prevention • 23-1/2" wall bracket with 17" height range 	1.3 GPM (4.9 L/min) max.			
		N207R0CH	372.05	Chrome/White	2
		N207R0SRN	420.70	Spot Resist Brushed Nickel	2
		N207R0BLC	428.15	Matte Black/Chrome	2
		N207R0BL	484.25	Matte Black	2
	MOEN SPA SHOWER RAIL HANDSHOWER & MAGNETIC DOCK - PREMIUM <ul style="list-style-type: none"> • handshower: single-function • showerhead size: 2-1/2" diameter • type of function: atomized spray • hose length: 59" • compatability: only with Moen Spa Shower Rails 	0.4 gpm (1.5 L/m)			
		N207H0CH	110.30	Chrome/White	2
		N207H0SRN	138.40	Spot Resist Brushed Nickel	2
		N207H0BLC	147.75	Matte Black/Chrome	2
		N207H0BL	185.10	Matte Black	2
	MOEN MAGNETIC DOCK - PREMIUM <ul style="list-style-type: none"> • includes: magnetic docking system • compatability: only with Moen Spa Shower Magnetix Handhelds • includes: two installation options - permanent waterproof adhesive or wall bracket with screw 	N207Z0GLC	31.70	Glacier/Chrome	6
		N207Z0SRN	33.70	Spot Resist Brushed Nickel	6
		N207Z0BL	35.50	Matte Black	6
		ANNEX™ SHOWER RAIL - PREMIUM			
	<ul style="list-style-type: none"> • connection: 1/2" IPS • showerhead: sold separately • handshower: sold separately • type of function: two independent functions • hose length: 59" 	TS3661NH	700.40	Chrome	3
		TS3661NHBN	1106.45	Brushed Nickel	3
		TS3661NHBG	1106.45	Brushed Gold	3
		TS3661NHBL	1167.50	Matte Black	3
		TS3661NHORB	1167.50	Oil Rubbed Bronze	3

CUSTOM SHOWERING

M-CORE® 4-Series Valve Only Shower Options

		MODEL	LIST	FINISH/CONNECT	CASE QTY
WEYMOUTH® M-CORE® 4-SERIES VALVE ONLY TRIM - PREMIUM					
	• includes: thermostatic cartridge with volume and temperature control • valve: sold separately  	UTS43101	750.75	Chrome	3
		UTS43101BN	925.40	Brushed Nickel	3
		UTS43101NL	925.40	Polished Nickel	3
		UTS43101BG	925.40	Brushed Gold	3
		UTS43101BL	973.50	Matte Black	3
		UTS43101ORB	973.50	Oil Rubbed Bronze	3
ARRIS® M-CORE® 4-SERIES VALVE ONLY TRIM - PREMIUM					
	• includes: thermostatic cartridge with volume and temperature control • valve: sold separately  	UTS42001	702.60	Chrome	3
		UTS42001BL	944.15	Matte Black	3
FLARA™ M-CORE® 4-SERIES VALVE ONLY TRIM - PREMIUM					
	• includes: thermostatic cartridge with volume and temperature control • valve: sold separately  	UTS4910	680.20	Chrome	3
		UTS4910BN	858.05	Brushed Nickel	3
		UTS4910NL	858.05	Polished Nickel	3
		UTS4910BG	858.05	Brushed Gold	3
COLINET™ M-CORE® 4-SERIES VALVE ONLY TRIM - PREMIUM					
	• includes: thermostatic cartridge with volume and temperature control • valve: sold separately  	UTS444301	655.65	Chrome	3
		UTS444301BN	825.50	Brushed Nickel	3
		UTS444301BG	825.50	Brushed Gold	3
		UTS444301BL	894.50	Matte Black	3
90°™ M-CORE® 4-SERIES VALVE ONLY TRIM - PREMIUM					
	• includes: thermostatic cartridge with volume and temperature control • valve: sold separately  	Q2  UTS4711	570.20	Chrome	3
		Q2  UTS4711BN	949.30	Brushed Nickel	3
		Q3  UTS4711BL	961.85	Matte Black	3
DOUX™ M-CORE® 4-SERIES VALVE ONLY TRIM - PREMIUM					
	• includes: thermostatic cartridge with volume and temperature control • valve: sold separately  	UTS4201	586.50	Chrome	3
		UTS4201BN	704.30	Brushed Nickel	3
		UTS4201BL	742.30	Matte Black	3
GREENFIELD™ M-CORE® 4-SERIES VALVE ONLY TRIM					
	• includes: thermostatic cartridge with volume and temperature control • valve: sold separately  	UT4321	483.05	Chrome	3
		UT4321BN	706.30	Brushed Nickel	3
		UT4321BG	706.30	Brushed Gold	3
		UT4321BL	763.40	Matte Black	3
WYNFORD® M-CORE® 4-SERIES VALVE ONLY TRIM					
	• includes: thermostatic cartridge with volume and temperature control • valve: sold separately  	UT45501	483.05	Chrome	3
		UT45501BN	706.30	Brushed Nickel	3
		UT45501ORB	748.50	Oil Rubbed Bronze	3

M-CORE® 4-Series Valve Only Shower Options

















		MODEL	LIST	FINISH/CONNECT	CASE QTY	
ALIGN® 	M-CORE® 4-SERIES VALVE ONLY TRIM					
	NEW! Q2	<ul style="list-style-type: none"> includes: thermostatic cartridge with volume and temperature control valve: sold separately 	UT4291	483.05	Chrome	3
			UT4291BN	706.30	Brushed Nickel	3
			UT4291BG	706.30	Brushed Gold	3
			UT4291BL	763.40	Matte Black	3
RIZON® 	M-CORE® 4-SERIES VALVE ONLY TRIM					
	NEW! Q2	<ul style="list-style-type: none"> includes: thermostatic cartridge with volume and temperature control valve: sold separately 	UT4811	483.05	Chrome	3
			UT4811BL	748.50	Matte Black	3
BELFIELD™ 	M-CORE® 4-SERIES VALVE ONLY TRIM					
		<ul style="list-style-type: none"> includes: thermostatic cartridge with volume and temperature control valve: sold separately 	Q2 NEW! UT4311	455.75	Chrome	3
			Q2 NEW! UT4311BN	682.80	Brushed Nickel	3
			Q2 NEW! UT4311NL	682.80	Polished Nickel	3
			Q3 NEW! UT4311BL	696.25	Matte Black	3
		Q2 NEW! UT4311ORB	722.45	Oil Rubbed Bronze	3	
CIA™ 	M-CORE® 4-SERIES VALVE ONLY TRIM					
	NEW! Q2	<ul style="list-style-type: none"> includes: thermostatic cartridge with volume and temperature control valve: sold separately 	UT4361	469.00	Chrome	3
			UT4361BN	683.25	Brushed Nickel	3
			UT4361BG	683.25	Brushed Gold	3
		UT4361BL	738.05	Matte Black	3	
VOSS™ 	M-CORE® 4-SERIES VALVE ONLY TRIM					
		<ul style="list-style-type: none"> includes: thermostatic cartridge with volume and temperature control valve: sold separately 	Q2 NEW! UT4691	469.00	Chrome	3
			Q2 NEW! UT4691BN	683.25	Brushed Nickel	3
			Q2 NEW! UT4691NL	683.25	Polished Nickel	3
			Q2 NEW! UT4691BG	683.25	Brushed Gold	3
			Q3 NEW! UT4691BL	686.10	Matte Black	3
		Q2 NEW! UT4691ORB	723.85	Oil Rubbed Bronze	3	

CUSTOM SHOWERING

M-CORE® 3-Series Valve Only Shower Options

		MODEL	LIST	FINISH/CONNECT	CASE QTY
	M-CORE® 3-SERIES VALVE ONLY TRIM - PREMIUM • includes: pressure balanced cartridge with volume and temperature control • valve: sold separately  	UTS33101	615.75	Chrome	3
		UTS33101BN	790.40	Brushed Nickel	3
		UTS33101NL	790.40	Polished Nickel	3
		UTS33101BG	790.40	Brushed Gold	3
		UTS33101BL	838.50	Matte Black	3
		UTS33101ORB	838.50	Oil Rubbed Bronze	3
	M-CORE® 3-SERIES VALVE ONLY TRIM - PREMIUM • includes: pressure balanced cartridge with volume and temperature control • valve: sold separately  	UTS32001	567.60	Chrome	3
		UTS32001BL	809.15	Matte Black	3
	M-CORE® 3-SERIES VALVE ONLY TRIM - PREMIUM • includes: pressure balanced cartridge with volume and temperature control • valve: sold separately  	UTS3911	545.20	Chrome	3
		UTS3911BN	723.05	Brushed Nickel	3
		UTS3911NL	723.05	Polished Nickel	3
		UTS3911BG	723.05	Brushed Gold	3
	M-CORE® 3-SERIES VALVE ONLY TRIM - PREMIUM • includes: pressure balanced cartridge with volume and temperature control • valve: sold separately  	UTS344301	520.65	Chrome	3
		UTS344301BN	690.50	Brushed Nickel	3
		UTS344301BG	690.50	Brushed Gold	3
		UTS344301BL	759.50	Matte Black	3
	M-CORE® 3-SERIES VALVE ONLY TRIM - PREMIUM • includes: pressure balanced cartridge with volume and temperature control • valve: sold separately  	UTS3711	435.20	Chrome	3
		UTS3711BN	814.30	Brushed Nickel	3
		Q3  UTS3711BL	826.85	Matte Black	3
	M-CORE® 3-SERIES VALVE ONLY TRIM - PREMIUM • includes: pressure balanced cartridge with volume and temperature control • valve: sold separately  	UTS3201	451.50	Chrome	3
		UTS3201BN	569.30	Brushed Nickel	3
		UTS3201BL	607.30	Matte Black	3
	M-CORE® 3-SERIES VALVE ONLY TRIM • includes: pressure balanced cartridge with volume and temperature control • valve: sold separately  	NEW! Q3 UTS33321	348.05	Chrome	3
		UTS33321BN	571.30	Brushed Nickel	3
		UTS33321BG	571.30	Brushed Gold	3
		UTS33321BL	628.40	Matte Black	3
	M-CORE® 3-SERIES VALVE ONLY TRIM • includes: pressure balanced cartridge with volume and temperature control • valve: sold separately  	UT35501	348.05	Chrome	3
		UT35501BN	571.30	Brushed Nickel	3
		UT35501ORB	613.50	Oil Rubbed Bronze	3

M-CORE® 3-Series Valve Only Shower Options















		MODEL	LIST	FINISH/CONNECT	CASE QTY
	M-CORE® 3-SERIES VALVE ONLY TRIM • includes: pressure balanced cartridge with volume and temperature control • valve: sold separately  	UT3291	348.05	Chrome	3
		UT3291BN	571.30	Brushed Nickel	3
		UT3291BG	571.30	Brushed Gold	3
		UT3291BL	628.40	Matte Black	3
		RIZON® M-CORE® 3-SERIES VALVE ONLY TRIM			
	• includes: pressure balanced cartridge with volume and temperature control • valve: sold separately  	UT3811	348.05	Chrome	3
		UT3811BL	613.50	Matte Black	3
BELFIELD™ M-CORE® 3-SERIES VALVE ONLY TRIM					
	• includes: pressure balanced cartridge with volume and temperature control • valve: sold separately  	UT3311	320.75	Chrome	3
		UT3311BN	547.80	Brushed Nickel	3
		UT3311NL	547.80	Polished Nickel	3
		Q3  UT3311BL	561.25	Matte Black	3
		UT3311ORB	587.45	Oil Rubbed Bronze	3
CIA™ M-CORE® 3-SERIES VALVE ONLY TRIM					
	• includes: pressure balanced cartridge with volume and temperature control • valve: sold separately  	UT3361	334.00	Chrome	3
		UT3361BN	548.25	Brushed Nickel	3
		UT3361BG	548.25	Brushed Gold	3
		UT3361BL	603.05	Matte Black	3
VOSS™ M-CORE® 3-SERIES VALVE ONLY TRIM					
	• includes: pressure balanced cartridge with volume and temperature control • valve: sold separately  	UT3691	334.00	Chrome	3
		UT3691BN	548.25	Brushed Nickel	3
		UT3691NL	548.25	Polished Nickel	3
		UT3691BG	548.25	Brushed Gold	3
		Q3  UT3691BL	551.10	Matte Black	3
		UT3691ORB	588.85	Oil Rubbed Bronze	3

CUSTOM SHOWERING

M-CORE® 2-Series Valve Only Shower Options











		MODEL	LIST	FINISH/CONNECT	CASE QTY
WEYMOUTH® 	M-CORE® 2-SERIES VALVE ONLY TRIM - PREMIUM • includes: pressure balanced cartridge with temperature control • valve: sold separately  	UTS23210	514.80	Chrome	3
		UTS23210BN	681.50	Brushed Nickel	3
		UTS23210NL	681.50	Polished Nickel	3
		UTS23210BG	681.50	Brushed Gold	3
		UTS23210BL	726.50	Matte Black	3
		UTS23210ORB	726.50	Oil Rubbed Bronze	3
ARRIS® 	M-CORE® 2-SERIES VALVE ONLY TRIM - PREMIUM • includes: pressure balanced cartridge with temperature control • valve: sold separately  	UTS22001	486.45	Chrome	3
		UTS22001BL	724.05	Matte Black	3
FLARA™ 	M-CORE® 2-SERIES VALVE ONLY TRIM - PREMIUM • includes: pressure balanced cartridge with temperature control • valve: sold separately  	UTS2911	437.85	Chrome	3
		UTS2911BN	581.30	Brushed Nickel	3
		UTS2911NL	581.30	Polished Nickel	3
		UTS2911BG	581.30	Brushed Gold	3
COLINET™ 	M-CORE® 2-SERIES VALVE ONLY TRIM - PREMIUM • includes: pressure balanced cartridge with temperature control • valve: sold separately  	UTS244201	425.35	Chrome	3
		UTS244201BN	562.60	Brushed Nickel	3
		UTS244201BG	562.60	Brushed Gold	3
		UTS244201BL	603.75	Matte Black	3
90™ 	M-CORE® 2-SERIES VALVE ONLY TRIM - PREMIUM • includes: pressure balanced cartridge with temperature control • valve: sold separately  	UTS2711	380.15	Chrome	3
		UTS2711BN	581.40	Brushed Nickel	3
		Q3  UTS2711BL	589.20	Matte Black	3
DOUX™ 	M-CORE® 2-SERIES VALVE ONLY TRIM - PREMIUM • includes: pressure balanced cartridge with temperature control • valve: sold separately  	UTS2201	401.15	Chrome	3
		UTS2201BN	513.85	Brushed Nickel	3
		UTS2201BL	550.05	Matte Black	3
GREENFIELD™ 	M-CORE® 2-SERIES VALVE ONLY TRIM • includes: pressure balanced cartridge with temperature control • valve: sold separately  	NEW! Q3 UT2321	293.05	Chrome	3
		UT2321BN	429.15	Brushed Nickel	3
		UT2321BG	429.15	Brushed Gold	3
		UT2321BL	459.55	Matte Black	3
WYNFORD® 	M-CORE® 2-SERIES VALVE ONLY TRIM • includes: pressure balanced cartridge with temperature control • valve: sold separately  	UT24501	293.05	Chrome	3
		UT24501BN	429.15	Brushed Nickel	3
		UT24501ORB	459.55	Oil Rubbed Bronze	3

M-CORE® 2-Series Valve Only Shower Options











		MODEL	LIST	FINISH/CONNECT	CASE QTY
	M-CORE® 2-SERIES VALVE ONLY TRIM • red/blue markings: included • includes: pressure balanced cartridge with temperature control • valve: sold separately  	UT2191	293.05	Chrome	3
		UT2191BN	429.15	Brushed Nickel	3
		UT2191BG	429.15	Brushed Gold	3
		UT2191BL	459.55	Matte Black	3
		RIZON® M-CORE® 2-SERIES VALVE ONLY TRIM			
	• red/blue markings: included • includes: pressure balanced cartridge with temperature control • valve: sold separately  	UT2811	293.05	Chrome	3
		UT2811BL	459.50	Matte Black	3
BELFIELD™ M-CORE® 2-SERIES VALVE ONLY TRIM					
	• includes: pressure balanced cartridge with temperature control • valve: sold separately  	UT2311	286.95	Chrome	3
		UT2311BN	418.10	Brushed Nickel	1
		UT2311NL	418.10	Polished Nickel	3
		Q3  UT2311BL	430.45	Matte Black	3
		UT2311ORB	447.35	Oil Rubbed Bronze	3
CIA™ M-CORE® 2-SERIES VALVE ONLY TRIM					
	• includes: pressure balanced cartridge with temperature control • valve: sold separately  	UT2261	281.20	Chrome	3
		UT2261BN	411.90	Brushed Nickel	3
		UT2261BG	411.90	Brushed Gold	3
		UT2261BL	441.05	Matte Black	3
VOSS™ M-CORE® 2-SERIES VALVE ONLY TRIM					
	• includes: pressure balanced cartridge with temperature control • valve: sold separately  	UT2691	281.20	Chrome	3
		UT2691BN	411.90	Brushed Nickel	3
		UT2691NL	411.90	Polished Nickel	3
		UT2691BG	411.90	Brushed Gold	3
		Q3  UT2691BL	421.85	Matte Black	3
UT2691ORB	441.05	Oil Rubbed Bronze	3		
DARTMOOR™ M-CORE® 2-SERIES VALVE ONLY TRIM					
	• includes: pressure balanced cartridge with temperature control • valve: sold separately  	UT2181	177.75	Chrome	3
		UT2181BN	282.70	Brushed Nickel	3
		UT2181BL	298.85	Matte Black	3
		UT2181ORB	298.85	Oil Rubbed Bronze	3
GLYDE™ M-CORE® 2-SERIES VALVE ONLY TRIM					
	• includes: pressure balanced cartridge with temperature control • valve: sold separately  	UT2741	177.75	Chrome	3
		UT2741BN	282.70	Brushed Nickel	1
		UT2741BL	298.85	Matte Black	3
BRANTFORD® M-CORE® 2-SERIES VALVE ONLY TRIM					
	• includes: pressure balanced cartridge with temperature control • valve: sold separately  	UT2151	177.75	Chrome	3
		UT2151BN	282.70	Brushed Nickel	3
		UT2151ORB	298.85	Oil Rubbed Bronze	3

CUSTOM SHOWERING

M-CORE® 2-Series Valve Only Shower Options



























		MODEL	LIST	FINISH/CONNECT	CASE QTY	
	EVA®	M-CORE® 2-SERIES VALVE ONLY TRIM				
	<ul style="list-style-type: none"> • includes: pressure balanced cartridge with temperature control • valve: sold separately 	UT2131	177.75	Chrome	3	
		UT2131BN	282.70	Brushed Nickel	3	
		UT2131ORB	298.85	Oil Rubbed Bronze	3	
	VICHY™	M-CORE® 2-SERIES VALVE ONLY TRIM				
	<ul style="list-style-type: none"> • red/blue markings: included • includes: pressure balanced cartridge with temperature control • valve: sold separately 	UT2661	189.85	Chrome	3	
	GIBSON™	M-CORE® 2-SERIES VALVE ONLY TRIM				
		<ul style="list-style-type: none"> • red/blue markings: included • includes: pressure balanced cartridge with temperature control • valve: sold separately 	UT2901	189.85	Chrome	3
			UT2901BN	263.35	Brushed Nickel	3
			UT2901BL	277.70	Matte Black	3
	GENTA™ LX	M-CORE® 2-SERIES VALVE ONLY TRIM				
		<ul style="list-style-type: none"> • red/blue markings: included • includes: pressure balanced cartridge with temperature control • valve: sold separately 	UT2471	186.90	Chrome	3
			UT2471BN	257.00	Brushed Nickel	3
			UT2471BL	270.75	Matte Black	3
	CHATEAU®	M-CORE® 2-SERIES VALVE ONLY TRIM				
	<ul style="list-style-type: none"> • red/blue markings: included • includes: pressure balanced cartridge with temperature control • valve: sold separately 	UTL181	153.30	Chrome	3	

Posi-Temp® Valve Only Shower Options











		MODEL	LIST	FINISH/CONNECT	CASE QTY
	WEYMOUTH® POSI-TEMP® VALVE ONLY TRIM - PREMIUM • valve: sold separately  	TS3210	402.10	Chrome	3
		TS3210BN	568.75	Brushed Nickel	3
		TS3210NL	568.75	Polished Nickel	3
		TS3210BG	568.75	Brushed Gold	3
		TS3210BL	613.80	Matte Black	3
		TS3210ORB	613.80	Oil Rubbed Bronze	3
	ARRIS® POSI-TEMP® VALVE ONLY TRIM - PREMIUM • valve: sold separately  	TS22001	373.70	Chrome	3
		TS22001BL	611.35	Matte Black	3
	FLARA™ POSI-TEMP® VALVE ONLY TRIM - PREMIUM • valve: sold separately  	TS2911	286.85	Chrome	3
		TS2911BN	430.20	Brushed Nickel	3
		TS2911NL	430.20	Polished Nickel	3
		TS2911BG	430.20	Brushed Gold	3
	COLINET™ POSI-TEMP® VALVE ONLY TRIM - PREMIUM • valve: sold separately  	TS44201	274.35	Chrome	3
		TS44201BN	411.60	Brushed Nickel	3
		TS44201BG	411.60	Brushed Gold	3
		TS44201BL	452.75	Matte Black	3
	90°™ POSI-TEMP® VALVE ONLY TRIM - PREMIUM • valve: sold separately  	TS2711	236.30	Chrome	3
		TS2711BN	437.60	Brushed Nickel	3
		Q3  TS2711BL	449.00	Matte Black	3
	DOUX™ POSI-TEMP® VALVE ONLY TRIM - PREMIUM • valve: sold separately  	TS2201	250.15	Chrome	3
		TS2201BN	362.80	Brushed Nickel	3
		TS2201BL	399.05	Matte Black	3
	GREENFIELD™ POSI-TEMP® VALVE ONLY TRIM • valve: sold separately  	T2221	166.90	Chrome	3
		T2221BN	303.00	Brushed Nickel	3
		T2221BG	303.00	Brushed Gold	3
		T2221BL	333.40	Matte Black	3
	WYNFORD® POSI-TEMP® VALVE ONLY TRIM • valve: sold separately  	T4501	166.90	Chrome	3
		T4501BN	303.00	Brushed Nickel	3
		T4501ORB	333.40	Oil Rubbed Bronze	3
	ALIGN® POSI-TEMP® VALVE ONLY TRIM • red/blue markings: included • valve: sold separately  	T2191	166.90	Chrome	3
		T2191BN	303.00	Brushed Nickel	3
		T2191BG	303.00	Brushed Gold	3
		T2191BL	333.40	Matte Black	3

CUSTOM SHOWERING

Posi-Temp® Valve Only Shower Options

		MODEL	LIST	FINISH/CONNECT	CASE QTY
	POSI-TEMP® VALVE ONLY TRIM • red/blue markings: included • valve: sold separately  	T2811	166.90	Chrome	3
		T2811BL	333.35	Matte Black	3
	POSI-TEMP® VALVE ONLY TRIM • valve: sold separately  	T2311	160.85	Chrome	3
		T2311BN	292.00	Brushed Nickel	3
		T2311NL	292.00	Polished Nickel	3
		Q3  T2311BL	297.60	Matte Black	3
		T2311ORB	321.20	Oil Rubbed Bronze	3
	POSI-TEMP® VALVE ONLY TRIM • red/blue markings: included • valve: sold separately  	T2261	160.15	Chrome	3
		T2261BN	290.85	Brushed Nickel	3
		T2261BG	290.85	Brushed Gold	3
		T2261BL	320.05	Matte Black	3
	POSI-TEMP® VALVE ONLY TRIM • valve: sold separately  	T2691	160.15	Chrome	3
		T2691BN	290.85	Brushed Nickel	3
		T2691NL	290.85	Polished Nickel	3
		T2691BG	290.85	Brushed Gold	3
		Q3  T2691BL	296.30	Matte Black	3
		T2691ORB	320.05	Oil Rubbed Bronze	3
	POSI-TEMP® VALVE ONLY TRIM • valve: sold separately  	T2181	71.15	Chrome	3
		T2181BN	162.55	Brushed Nickel	3
		T2181BL	178.70	Matte Black	3
		T2181ORB	178.70	Oil Rubbed Bronze	3
	POSI-TEMP® VALVE ONLY TRIM • valve: sold separately  	T2741	71.15	Chrome	3
		T2741BN	162.55	Brushed Nickel	3
		T2741BL	178.70	Matte Black	3
	POSI-TEMP® VALVE ONLY TRIM • valve: sold separately  	T2151	71.15	Chrome	3
		T2151BN	162.55	Brushed Nickel	3
		T2151ORB	178.70	Oil Rubbed Bronze	3
	POSI-TEMP® VALVE ONLY TRIM • valve: sold separately  	T2131	71.15	Chrome	3
		T2131BN	162.55	Brushed Nickel	3
		T2131ORB	178.70	Oil Rubbed Bronze	3

Posi-Temp® Valve Only Shower Options

		MODEL	LIST	FINISH/CONNECT	CASE QTY
GIBSON™ POSI-TEMP® VALVE ONLY TRIM					
 <ul style="list-style-type: none"> • red/blue markings: included • valve: sold separately 	 	T2901	69.75	Chrome	3
		T2901BN	143.20	Brushed Nickel	3
		T2901BL	157.55	Matte Black	3
GENTA™ LX POSI-TEMP® VALVE ONLY TRIM					
 <ul style="list-style-type: none"> • red/blue markings: included • valve: sold separately 	 	T2471	66.80	Chrome	3
		T2471BN	136.85	Brushed Nickel	3
		T2471BL	150.60	Matte Black	3
CHATEAU® POSI-TEMP® VALVE ONLY TRIM					
 <ul style="list-style-type: none"> • red/blue markings: included • valve: sold separately 		T181	44.55	Chrome	12
 <ul style="list-style-type: none"> • red/blue markings: included • valve: sold separately 	 	TL181	44.55	Chrome	12

CUSTOM SHOWERING

POSI-TEMP®**Multi-Function Showering Options**

Moen has all the components necessary for you to build a custom shower spa. And, we're making it easy for you to pull together the sku numbers you need. Charts of common shower spa configurations are included so that all the components can be ordered. The charts below illustrate one layout and option of showering components. Refer to pages 429 - 460 in the Custom Showering section to choose from our wide array of showering products, styles and finishes to meet your preference. For additional assistance, call your Moen Sales Representative.

**Shower Spa Options****POSI-TEMP® SHOWER HEAD & HANDSHOWER**

3 function (2 discrete/1 shared)
or
2 function (2 discrete)
Belfield™ suite shown.

Suite	Posi-Temp 2 Function [2 discrete] -or- 3 Function [2 discrete / 1 shared] Transfer Valve with W=Volume Control Valve Trim	Showerhead	Shower Arm	Shower Arm Flange	Handheld Shower with Slide Bar	Drop Ell
Weymouth®	TS32100	S1311	S113		S12107EP	A725
Arris®	TS22000	S112	S110		3887EP	A725
90°®	TS2710	S6340	123815	147572	S3880EP	A721
Doux™	TS22000	S176	123815	137488	3887EP	A725
Wynford®	T4500	S6310	123815	AT2199	3667EP	A725
Align®	T2190	S176	123815	137488	3887EP	A725
Rizon®	T2810	6345	123815	AT2199	3988EP	A721
Belfield™	T2310	S6310	123815	AT2199	3667EP	A725
Voss™	T2690	S6365	123815	AT2199	3988EP	A721
Gibson™	T2900	6345	123815	137488	3669EP	A725
Genta™ LX	T2470	6345	123815	137488	3988EP	A721

* 2551 / 2581 - 2 independent + 1 shared function.

* 2521 / 2571 - 2 independent functions.

Valve	Flow Rate through shower port (GPM) @ 20 PSI	Flow Rate through shower port (GPM) @ 40 PSI	Flow Rate through shower port (GPM) @ 60 PSI	Used with 2- or 3-Function Transfer
Posi-Temp® valves 2521, 2571, 2551, 2581	*3.0	*4.0	*5.0	No

Posi-Temp® Multi-Function Showering Configuration

CUSTOM SHOWERING

POSI-TEMP® SHOWER, SHOWERHEAD & BODY SPRAYS



3 function (2 discrete/1 shared)
or
2 function (2 discrete)
Belfield™ suite shown.

Suite	Posi-Temp® 2 Function (2 discrete) -or- 3 Function (2 discrete / 1 shared) Transfer Valve with Volume Control Valve Trim	Showerhead	Shower Arm	Shower Arm Flange	Bodyspray and Quantity
Weymouth®	TS32100	S1311	S113		A501 x 2
Arris®	TS22000	S112	S110		A501 x 2
90°®	TS2710	S6340	123815	147572	A501 x 2
Doux™	TS22000	S176	123815	137488	A501 x 2
Wynford®	T4500	S6310	123815	AT2199	A501 x 2
Align®	T2190	S176	123815	137488	A501 x 2
Rizon®	T2810	6345	123815	AT2199	A501 x 2
Belfield™	T2310	S6310	123815	AT2199	A501 x 2
Voss™	T2690	S6365	123815	AT2199	A501 x 2
Gibson™	T2900	6345	123815	137488	A501 x 2
Genta™ LX	T2470	6345	123815	137488	A501 x 2

* 2551 / 2581 - 2 independent + 1 shared function.

* 2521 / 2571 - 2 independent functions.

Valve	Flow Rate through shower port (GPM) @ 20 PSI	Flow Rate through shower port (GPM) @ 40 PSI	Flow Rate through shower port (GPM) @ 60 PSI	Used with 2- or 3-Function Transfer
Posi-Temp® valves 2521, 2571, 2551, 2581	*3.0	*4.0	*5.0	No

Posi-Temp® Multi-Function Showering Configuration

POSI-TEMP® SHOWER, SHOWERHEAD & TUB SPOUT



3 function (2 discrete/1 shared)
or
2 function (2 discrete)
Belfield™ suite shown.

Suite	Posi-Temp 2 Function [2 discrete] -or- 3 Function [2 discrete / 1 shared] Transfer Valve with W=Volume Control Valve Trim	Showerhead	Shower Arm	Shower Arm Flange	Non-diverter Tub Spout
Weymouth®	TS32100	S1311	S113		S12105
Arris®	TS22000	S112	S110		S16900
90°®	TS2710	S6340	123815	147572	S3898
Doux™	TS22000	S176	123815	137488	S3836
Wynford®	T4500	S6310	123815	AT2199	S195386
Align®	T2190	S176	123815	137488	3892
Rizon®	T2810	6345	123815	AT2199	3829
Belfield™	T2310	S6310	123815	AT2199	3858
Voss™	T2690	S6365	123815	AT2199	191956
Gibson™	T2900	6345	123815	137488	3892
Genta™ LX	T2470	6345	123815	137488	3829



























* 2551 / 2581 - 2 independent + 1 shared function.

* 2521 / 2571 - 2 independent functions.











Valve	Flow Rate through shower port (GPM) @ 20 PSI	Flow Rate through shower port (GPM) @ 40 PSI	Flow Rate through shower port (GPM) @ 60 PSI	Used with 2- or 3-Function Transfer
Posi-Temp® valves 2521, 2571, 2551, 2581	*3.0	*4.0	*5.0	No

Posi-Temp® Multi-Function Showering Options





CUSTOM SHOWERING

WEYMOUTH®		POSI-TEMP® WITH INTEGRATED TRANSFER VALVE TRIM - PREMIUM			
	<ul style="list-style-type: none"> valve: sold separately  	TS32100	862.15	Chrome	4
		TS32100BN	1219.15	Brushed Nickel	4
		TS32100NL	1219.15	Polished Nickel	4
		TS32100BG	1219.15	Brushed Gold	4
		TS32100BL	1315.70	Matte Black	4
		TS32100ORB	1315.70	Oil Rubbed Bronze	4
ARRIS®		POSI-TEMP® WITH INTEGRATED TRANSFER VALVE TRIM - PREMIUM			
	<ul style="list-style-type: none"> valve: sold separately  	TS22000	801.35	Chrome	4
		TS22000BL	1310.60	Matte Black	4
90°™		POSI-TEMP® WITH INTEGRATED TRANSFER VALVE TRIM - PREMIUM			
	<ul style="list-style-type: none"> valve: sold separately  	TS2710	486.15	Chrome	4
		TS2710BN	900.05	Brushed Nickel	4
		Q3  TS2710BL	923.65	Matte Black	4
DOUX™		POSI-TEMP® WITH INTEGRATED TRANSFER VALVE TRIM - PREMIUM			
	<ul style="list-style-type: none"> valve: sold separately  	TS2200	523.05	Chrome	4
		TS2200BN	758.40	Brushed Nickel	4
		TS2200BL	834.30	Matte Black	4
WYNFORD®		POSI-TEMP® WITH INTEGRATED TRANSFER VALVE TRIM			
	<ul style="list-style-type: none"> valve: sold separately  	T4500	301.30	Chrome	4
		T4500BN	547.05	Brushed Nickel	4
		T4500ORB	601.90	Oil Rubbed Bronze	4
ALIGN®		POSI-TEMP® WITH INTEGRATED TRANSFER VALVE TRIM			
	<ul style="list-style-type: none"> red/blue markings: included valve: sold separately  	T2190	301.30	Chrome	4
		T2190BN	547.05	Brushed Nickel	4
		T2190BG	547.05	Brushed Gold	4
		T2190BL	601.90	Matte Black	4
RIZON®		POSI-TEMP® WITH INTEGRATED TRANSFER VALVE TRIM			
	<ul style="list-style-type: none"> red/blue markings: included valve: sold separately  	T2810	301.30	Chrome	4
		T2810BL	601.90	Matte Black	4
BELFIELD™		POSI-TEMP® WITH INTEGRATED TRANSFER VALVE TRIM			
	<ul style="list-style-type: none"> valve: sold separately  	T2310	290.35	Chrome	4
		T2310BN	527.20	Brushed Nickel	4
		T2310NL	527.20	Polished Nickel	4
		Q3  T2310BL	537.15	Matte Black	4
		T2310ORB	579.95	Oil Rubbed Bronze	4

Posi-Temp® Multi-Function Showering Options

		MODEL	LIST	FINISH/CONNECT	CASE QTY
	VOSS™ POSI-TEMP® WITH INTEGRATED TRANSFER VALVE TRIM • valve: sold separately  	T2690	289.20	Chrome	4
		T2690BN	525.10	Brushed Nickel	4
		T2690NL	525.10	Polished Nickel	4
		T2690BG	525.10	Brushed Gold	4
		Q3  T2690BL	534.95	Matte Black	4
		T2690ORB	577.60	Oil Rubbed Bronze	4
	GIBSON™ POSI-TEMP® WITH INTEGRATED TRANSFER VALVE TRIM • red/blue markings: included • valve: sold separately  	T2900	103.50	Chrome	4
		T2900BN	150.10	Brushed Nickel	4
		T2900BL	165.15	Matte Black	4
	GENTA™ LX POSI-TEMP® WITH INTEGRATED TRANSFER VALVE TRIM • red/blue markings: included • valve: sold separately  	T2470	99.15	Chrome	4
		T2470BN	143.75	Brushed Nickel	4
		T2470BL	154.85	Matte Black	4

1.5 GPM SHOWERING OPTIONS				
MODEL NUMBER	DESCRIPTION	LIST PRICE	FINISH	CASE QTY.
S6340EP15	Rainshower	254.10	Chrome	3
S6340EP15BN	Rainshower	349.35	Brushed Nickel	3
S6335EP15	Showerhead	199.25	Chrome	6
6302EP15	Showerhead	114.75	Chrome	12
6399EP15	Showerhead	122.35	Chrome	12
6399EP15BL	Showerhead	210.15	Matte Black	12
6313	Showerhead	63.45	Chrome	12
6313BN	Showerhead	97.20	Brushed Nickel	12
6313ORB	Showerhead	106.90	Oil Rubbed Bronze	12
6300EP15	Showerhead	44.50	Chrome	12
157276EP15	Handheld Shower	83.00	Chrome	6

	MODEL	LIST	FINISH/CONNECT	CASE QTY	
RAINSHOWER - PREMIUM					
<ul style="list-style-type: none"> • connection: 1/2" IPS • showerhead: two-function rainshower • showerhead size: 9" diameter • type of function: full spray; concentrated rinse  <p>IMMERSION</p>	2.5 GPM (9.5 L/min) max.				
	S1311	610.65	Chrome	3	
	S1311BN	833.45	Brushed Nickel	3	
	S1311NL	833.45	Polished Nickel	3	
	S1311BG	833.45	Brushed Gold	3	
	S1311BL	916.70	Matte Black	3	
	S1311ORB	916.70	Oil Rubbed Bronze	3	
	1.75 GPM (6.65 L/min) max.				
	S1311EP	610.65	Chrome	3	
	S1311EPBN	833.45	Brushed Nickel	3	
S1311EPNL	833.45	Polished Nickel	3		
S1311EPBG	833.45	Brushed Gold	3		
S1311EPBL	916.70	Matte Black	3		
S1311EPORB	916.70	Oil Rubbed Bronze	3		
<ul style="list-style-type: none"> • connection: 1/2" IPS • showerhead: single-function rainshower • showerhead size: 12" diameter • type of function: full rainshower • metal construction • recommended for over-head mount application only 	2.5 GPM (9.5 L/min) max.				
	S1002	580.70	Chrome	3	
	1.75 GPM (6.65 L/min) max.				
S1002EP	580.70	Chrome	3		
<ul style="list-style-type: none"> • connection: 1/2" IPS • showerhead: single-function rainshower • showerhead size: 12" diameter • type of function: full rainshower • metal construction • recommended for over-head mount application only 	2.5 GPM (9.5 L/min) max.				
	S1004	580.70	Chrome	3	
	1.75 GPM (6.65 L/min) max.				
S1004EP	580.70	Chrome	3		
<ul style="list-style-type: none"> • connection: 1/2" IPS • showerhead: single-function rainshower • showerhead size: 10" diameter • type of function: full rainshower • metal construction • recommended for over-head mount application only 	2.5 GPM (9.5 L/min) max.				
	S1001	544.40	Chrome	3	
	1.75 GPM (6.65 L/min) max.				
S1001EP	544.40	Chrome	3		
<ul style="list-style-type: none"> • connection: 1/2" IPS • showerhead: single-function rainshower • showerhead size: 10" diameter • type of function: full rainshower • metal construction • recommended for over-head mount application only 	2.5 GPM (9.5 L/min) max.				
	S1003	544.40	Chrome	3	
	1.75 GPM (6.65 L/min) max.				
S1003EP	544.40	Chrome	3		

Showerheads

RAINSHOWER - PREMIUM



- connection: 1/2" IPS
- showerhead: single-function rainshower
- showerhead size: 10" diameter
- type of function: full spray

IMMERSSION

MODEL LIST FINISH/CONNECT CASE QTY

2.5 GPM (9.5 L/min) max.

S112	572.40	Chrome	3
S112BN	775.05	Brushed Nickel	3
S112NL	775.05	Polished Nickel	3
S112BG	775.05	Brushed Gold	3
S112WR	852.50	Wrought Iron	3
S112ORB	852.50	Oil Rubbed Bronze	3

1.75 GPM (6.65 L/min) max.

S112EP	572.40	Chrome	3
S112EPBN	775.05	Brushed Nickel	3
S112EPNL	852.50	Polished Nickel	3
S112EPBG	775.05	Brushed Gold	3
S112EPWR	852.50	Wrought Iron	3
S112EPORB	852.50	Oil Rubbed Bronze	3



- connection: 1/2" IPS
- showerhead: two-function rainshower
- showerhead size: 8" diameter
- type of function: full spray; concentrated rinse

IMMERSSION

2.5 GPM (9.5 L/min) max.

S6320	387.05	Chrome	3
S6320BN	608.30	Brushed Nickel	3
S6320BG	608.30	Brushed Gold	3
S6320BL	669.00	Matte Black	3
S6320ORB	669.00	Oil Rubbed Bronze	3

1.75 GPM (6.65 L/min) max.

S6320EP	387.05	Chrome	3
S6320EPBN	608.30	Brushed Nickel	3
S6320EPBG	608.30	Brushed Gold	3
S6320EPBL	669.00	Matte Black	3
S6320EPORB	669.00	Oil Rubbed Bronze	3

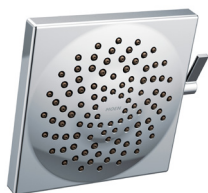

- connection: 1/2" IPS
- showerhead: two-function rainshower
- showerhead size: 8-1/2" diameter
- type of function: full rainshower; concentrated rinse; combination

IMMERSSION

2.5 GPM (9.5 L/min) max.

S6345	398.00	Chrome	3
S6345BN	625.50	Brushed Nickel	3
S6345BG	625.50	Brushed Gold	3
S6345BL	687.95	Matte Black	3

1.75 GPM (6.65 L/min) max.

S6345EP	398.00	Chrome	3
S6345EPBN	625.50	Brushed Nickel	3
S6345EPBG	625.50	Brushed Gold	3
S6345EPBL	687.95	Matte Black	3



- connection: 1/2" IPS
- showerhead: single-function rainshower
- showerhead size: 8" diameter
- type of function: full spray

IMMERSSION

2.5 GPM (9.5 L/min) max.

S6360	369.90	Chrome	3
S6360BN	554.85	Brushed Nickel	3
S6360ORB	611.25	Oil Rubbed Bronze	3

1.75 GPM (6.65 L/min) max.

S6360EP	369.90	Chrome	3
S6360EPBN	554.85	Brushed Nickel	3
S6360EPORB	611.25	Oil Rubbed Bronze	3



- connection: 1/2" IPS
- showerhead: single-function rainshower
- showerhead size: 6-3/4" diameter
- type of function: full spray

IMMERSSION

2.5 GPM (9.5 L/min) max.

S176	254.10	Chrome	3
S176BN	349.35	Brushed Nickel	3
S176BG	349.35	Brushed Gold	3
S176BL	366.80	Matte Black	3

1.75 GPM (6.65 L/min) max.

S176EP	254.10	Chrome	3
S176EPBN	349.35	Brushed Nickel	3
S176EPBG	349.35	Brushed Gold	3
S176EPBL	366.80	Matte Black	3

Showerheads

CUSTOM SHOWERING

RAINSHOWER - PREMIUM



- connection: 1/2" IPS
- showerhead: single-function rainshower
- showerhead size: 7" diameter
- type of function: full spray

IMMERSON

MODEL LIST FINISH/CONNECT CASE QTY

2.5 GPM (9.5 L/min) max.

S6310	254.10	Chrome	3
S6310BN	349.35	Brushed Nickel	3
S6310NL	332.65	Polished Nickel	3
S6310WR	366.80	Wrought Iron	3
S6310ORB	366.80	Oil Rubbed Bronze	3

1.75 GPM (6.65 L/min) max.

S6310EP	254.10	Chrome	3
S6310EPBN	349.35	Brushed Nickel	3
S6310EPNL	332.65	Polished Nickel	3
S6310EPWR	366.80	Wrought Iron	3
S6310EPORB	366.80	Oil Rubbed Bronze	3



- connection: 1/2" IPS
- showerhead: single-function rainshower
- showerhead size: 6" diameter
- type of function: full spray

IMMERSON

2.5 GPM (9.5 L/min) max.

S6340	254.10	Chrome	3
S6340BN	349.35	Brushed Nickel	3

1.75 GPM (6.65 L/min) max.

S6340EP	254.10	Chrome	3
S6340EPBN	349.35	Brushed Nickel	3



- connection: 1/2" IPS
- showerhead: single-function rainshower
- showerhead size: 6" diameter
- type of function: full spray

IMMERSON

2.5 GPM (9.5 L/min) max.

S6365	254.10	Chrome	3
S6365BN	349.35	Brushed Nickel	3
S6365NL	349.35	Polished Nickel	3
S6365BG	349.35	Brushed Gold	3
S6365BL	366.80	Matte Black	3
S6365ORB	366.80	Oil Rubbed Bronze	3

1.75 GPM (6.65 L/min) max.

S6365EP	254.10	Chrome	3
S6365EPBN	349.35	Brushed Nickel	3
S6365EPNL	349.35	Polished Nickel	3
S6365EPBG	349.35	Brushed Gold	3
S6365EPBL	366.80	Matte Black	3
S6365EPORB	366.80	Oil Rubbed Bronze	3

NEW Q3



- connection: 1/2" IPS
- showerhead: single-function rainshower
- showerhead size: 6-3/4" diameter
- type of function: full spray

IMMERSON

2.5 GPM (9.5 L/min) max.

S178	251.10	Chrome	3
S178BN	349.35	Brushed Nickel	3
S178BG	349.35	Brushed Gold	3
S178BL	366.80	Matte Black	3

1.75 GPM (6.65 L/min) max.

S178EP	251.10	Chrome	3
S178EPBN	349.35	Brushed Nickel	3
S178EPBG	349.35	Brushed Gold	3
S178EPBL	366.80	Matte Black	3



- connection: 1/2" IPS
- showerhead: four-function rainshower
- showerhead size: 6-1/2" diameter
- type of function: full spray

1.5 GPM (5.7 L/min) max.



N400ROCH	231.10	Chrome	2
N400ROBN	303.75	Brushed Nickel	2
N400ROBG	303.75	Brushed Gold	2
N400ROBL	332.80	Matte Black	2
N400ROORB	332.80	Oil Rubbed Bronze	2

Showerheads

	MODEL	LIST	FINISH/CONNECT	CASE QTY
RAINSHOWER				
 <ul style="list-style-type: none"> • Infniti™ dial allows user to precisely adjust to preferred balance of force and coverage • Magnetix technology: showerhead easily detaches from showerarm for cleaning and easily snaps back in place • connection: 1/2" IPS • showerhead size: 9" diameter 	2.5 GPM (9.5 L/min) max.			
	220R3	277.25	Chrome	2
	220R3BN	360.45	Brushed Nickel	2
	220R3BG	360.45	Brushed Gold	2
	220R3BL	414.50	Matte Black	2
	1.75 GPM (6.65 L/min) max.			
	220R3EP	277.25	Chrome	2
	220R3EPBN	360.45	Brushed Nickel	2
	220R3EPBG	360.45	Brushed Gold	2
	220R3EPBL	414.50	Matte Black	2
 <ul style="list-style-type: none"> • connection: 1/2" IPS • showerhead: single-function standard • showerhead size: 8" diameter • type of function: full spray 	2.5 GPM (9.5 L/min) max.			
	6345	109.75	Chrome	3
	6345BN	123.65	Brushed Nickel	3
	6345BG	123.65	Brushed Gold	3
	6345BL	137.50	Matte Black	3
	6345ORB	137.50	Oil Rubbed Bronze	3
	1.75 GPM (6.65 L/min) max.			
	6345EP	109.75	Chrome	3
	6345EPBN	123.65	Brushed Nickel	3
	6345EPBG	123.65	Brushed Gold	3
6345EPBL	137.50	Matte Black	3	
6345EPORB	137.50	Oil Rubbed Bronze	3	
FIXED SHOWER HEAD - PREMIUM				
 <ul style="list-style-type: none"> • connection: 1/2" IPS • showerhead: single-function standard • showerhead size: 6-1/2" diameter • type of function: full spray 	2.5 GPM (9.5 L/min) max.			
	S6335	199.25	Chrome	6
	S6335BN	271.25	Brushed Nickel	6
	1.75 GPM (6.65 L/min) max.			
	S6335EP	199.25	Chrome	6
	S6335EPBN	271.25	Brushed Nickel	6
 <ul style="list-style-type: none"> • connection: 1/2" IPS • showerhead: single-function standard • showerhead size: 5-7/8" diameter • type of function: full spray 	1.5 GPM (5.7 L/min) max.			
	S6335EP15	199.25	Chrome	6
	2.5 GPM (9.5 L/min) max.			
	S6312	165.30	Chrome	12
	S6312BN	196.45	Brushed Nickel	12
	S6312NL	196.45	Polished Nickel	12
S6312ORB	216.05	Oil Rubbed Bronze	12	
1.75 GPM (6.65 L/min) max.				
S6312EP	165.30	Chrome	12	
S6312EPBN	196.45	Brushed Nickel	12	
S6312EPNL	196.45	Polished Nickel	6	
S6312EPORB	216.05	Oil Rubbed Bronze	12	
FIXED SHOWER HEAD				
 <ul style="list-style-type: none"> • connection: 1/2" IPS • showerhead: four-function standard • showerhead size: 4-3/8" diameter • type of function: full spray; invigorating spray; combination; targeted massage 	2.5 GPM (9.5 L/min) max.			
	3638	132.65	Chrome	12
	3638BN	225.15	Brushed Nickel	12
	3638BG	225.15	Brushed Gold	12
	3638BL	227.30	Matte Black	12
	3638ORB	247.75	Oil Rubbed Bronze	12
	1.75 GPM (6.65 L/min) max.			
	3638EP	132.65	Chrome	12
	3638EPBN	225.15	Brushed Nickel	12
	3638EPBG	206.55	Brushed Gold	12
3638EPBL	219.10	Matte Black	12	
 <ul style="list-style-type: none"> • connection: 1/2" IPS • showerhead: six-function eco-performance • showerhead size: 4-1/2" diameter • type of function: wide coverage; downpour; massage; relaxing spray; rinse; full spray 	1.75 GPM (6.65 L/min) max.			
	6512EP	134.65	Chrome	12
	6512EPBN	216.35	Brushed Nickel	12
	6512EPBL	238.10	Matte Black	12

Showerheads

CUSTOM SHOWERING

FIXED SHOWER HEAD		MODEL	LIST	FINISH/CONNECT	CASE QTY
	<ul style="list-style-type: none"> • connection: 1/2" IPS • showerhead: single-function standard • showerhead size: 4-3/8" diameter • type of function: full spray 	2.5 GPM (9.5 L/min) max.			
		6302	114.75	Chrome	12
		6302BN	179.10	Brushed Nickel	12
		6302WR	197.05	Wrought Iron	12
		6302ORB	197.05	Oil Rubbed Bronze	12
		1.75 GPM (6.65 L/min) max.			
		6302EP	114.75	Chrome	12
		6302EPBN	179.10	Brushed Nickel	12
		6302EPORB	197.05	Oil Rubbed Bronze	12
		1.5 GPM (5.7 L/min) max.			
6302EP15	114.75	Chrome	12		
	<ul style="list-style-type: none"> • connection: 1/2" IPS • showerhead: single-function standard • showerhead size: 4-3/8" diameter • type of function: full spray • carded packaging: yes 	2.5 GPM (9.5 L/min) max.			
		CL6302	114.75	Chrome	12
		CL6302BN	179.10	Brushed Nickel	12
		1.75 GPM (6.65 L/min) max.			
		CL6302EP	114.75	Chrome	12
		CL6302EPBN	179.10	Brushed Nickel	12
	<ul style="list-style-type: none"> • connection: 1/2" IPS • showerhead: single-function standard • showerhead size: 3-3/4" diameter • type of function: full spray 	2.5 GPM (9.5 L/min) max.			
		6322	113.35	Chrome	12
		6322BN	186.95	Brushed Nickel	12
		6322BL	187.20	Matte Black	12
		1.75 GPM (6.65 L/min) max.			
		6322EP	113.35	Chrome	12
6322EPBN	186.95	Brushed Nickel	12		
6322EPBL	187.20	Matte Black	12		
	<ul style="list-style-type: none"> • connection: 1/2" IPS • showerhead: single-function standard • showerhead size: 4-1/16" diameter • type of function: full spray 	2.5 GPM (9.5 L/min) max.			
		6325	113.35	Chrome	12
		6325BN	177.00	Brushed Nickel	12
		6325NL	177.00	Polished Nickel	12
		6325BG	177.00	Brushed Gold	12
		6325ORB	194.85	Oil Rubbed Bronze	12
		1.75 GPM (6.65 L/min) max.			
		6325EP	113.35	Chrome	12
		6325EPBN	177.00	Brushed Nickel	12
		6325EPNL	177.00	Polished Nickel	12
6325EPBG	177.00	Brushed Gold	12		
6325EPORB	194.85	Oil Rubbed Bronze	12		
	<ul style="list-style-type: none"> • connection: 1/2" IPS • showerhead: single-function standard • showerhead size: 3-5/8" diameter • type of function: full spray 	2.5 GPM (9.5 L/min) max.			
		6399	122.35	Chrome	12
		6399BN	190.95	Brushed Nickel	12
		6399BG	190.95	Brushed Gold	12
		6399BL	210.15	Matte Black	12
		1.75 GPM (6.65 L/min) max.			
		6399EP	122.35	Chrome	12
		6399EPBN	190.95	Brushed Nickel	12
		6399EPBG	190.95	Brushed Gold	12
		6399EPBL	210.15	Matte Black	12
1.5 GPM (5.7 L/min) max.					
6399EP15	122.35	Chrome	12		
6399EP15BL	210.15	Matte Black	12		
	<ul style="list-style-type: none"> • connection: 1/2" IPS • showerhead: single-function standard • showerhead size: 3-3/4" diameter • type of function: full spray 	2.5 GPM (9.5 L/min) max.			
		6370	71.90	Chrome	12
		6370BN	110.05	Brushed Nickel	12
		6370BL	121.20	Matte Black	12
		1.75 GPM (6.65 L/min) max.			
		6370EP	68.50	Chrome	12
6370EPBN	104.85	Brushed Nickel	3		
6370EPBL	115.40	Matte Black	12		

Showerheads











		MODEL	LIST	FINISH/CONNECT	CASE QTY
FIXED SHOWER HEAD					
	<ul style="list-style-type: none"> • connection: 1/2" IPS • showerhead: single-function standard • showerhead size: 4" diameter • type of function: full spray 	2.5 GPM (9.5 L/min) max.			
		6371	71.90	Chrome	12
		6371BN	110.05	Brushed Nickel	12
		6371BL	121.20	Matte Black	12
		6371ORB	121.20	Oil Rubbed Bronze	12
		1.75 GPM (6.65 L/min) max.			
		6371EP	68.50	Chrome	12
		6371EPBN	104.85	Brushed Nickel	12
		6371EPBL	115.40	Matte Black	12
		6371EPORB	115.40	Oil Rubbed Bronze	12
	<ul style="list-style-type: none"> • connection: 1/2" IPS • showerhead: five-function standard • showerhead size: 4" diameter • type of function: refreshing spray; energizing spray; relaxing spray; targeted massage; invigorating spray • carded packaging: yes 	2.5 GPM (9.5 L/min) max.			
		CL26500	67.60	Chrome	12
		CL26500BN	110.30	Brushed Nickel	12
		1.75 GPM (6.65 L/min) max.			
		CL26500EP	67.60	Chrome	12
		CL26500EPBN	110.30	Brushed Nickel	12
	<ul style="list-style-type: none"> • connection: 1/2" IPS • showerhead: single-function standard • showerhead size: 3-1/2" diameter • type of function: full spray 	2.5 GPM (9.5 L/min) max.			
		6303	63.45	Chrome	12
		6303BN	97.20	Brushed Nickel	12
		6303ORB	106.90	Oil Rubbed Bronze	12
		1.75 GPM (6.65 L/min) max.			
		6303EP	63.45	Chrome	12
6303EPBN	97.20	Brushed Nickel	12		
6303EPORB	106.90	Oil Rubbed Bronze	12		
	<ul style="list-style-type: none"> • connection: 1/2" IPS • showerhead: single-function eco-performance • showerhead size: 3-1/2" diameter • type of function: full spray 	1.5 GPM (5.7 L/min) max.			
		6313	63.45	Chrome	12
		6313BN	97.20	Brushed Nickel	12
		6313ORB	106.90	Oil Rubbed Bronze	12
	<ul style="list-style-type: none"> • connection: 1/2" IPS • showerhead: single-function standard • showerhead size: 3-1/2" diameter • type of function: full spray • carded packaging: yes 	2.5 GPM (9.5 L/min) max.			
		CL6303	63.45	Chrome	12
		CL6303BN	97.20	Brushed Nickel	12
		1.75 GPM (6.65 L/min) max.			
		CL6303EP	63.45	Chrome	12
		CL6303EPBN	97.20	Brushed Nickel	12
	<ul style="list-style-type: none"> • connection: 1/2" IPS • showerhead: four-function standard • showerhead size: 3-1/2" diameter • type of function: energizing massage; full spray; refreshing spray; invigorating spray 	2.5 GPM (9.5 L/min) max.			
		23026	44.10	Chrome	4
	<ul style="list-style-type: none"> • connection: 1/2" IPS • showerhead: three-function eco-performance • showerhead size: 3-3/4" diameter • type of function: full spray; refreshing spray; targeted massage 	1.75 GPM (6.65 L/min) max.			
		20001	38.55	Chrome	3
	<ul style="list-style-type: none"> • connection: 1/2" IPS • showerhead: single-function standard • showerhead size: 2-1/2" diameter • type of function: full spray 	2.5 GPM (9.5 L/min) max.			
		6300	44.50	Chrome	12
		6300BN	67.90	Brushed Nickel	12
		1.75 GPM (6.65 L/min) max.			
		6300EP	44.50	Chrome	12
		6300EPBN	67.90	Brushed Nickel	12
		1.5 GPM (5.7 L/min) max.			
		6300EP15	44.50	Chrome	12

Shower Arms and Flanges





	MODEL	LIST	FINISH/CONNECT	CASE QTY
 <ul style="list-style-type: none"> • connection: 1/2" IPS • length: 18" 	336651	84.45	Chrome	6
	336651BN	164.20	Brushed Nickel	6
	336651NL	164.20	Polished Nickel	6
	336651BG	164.20	Brushed Gold	6
	336651BL	180.45	Matte Black	6
	336651ORB	180.45	Oil Rubbed Bronze	6
 <ul style="list-style-type: none"> • connection: 1/2" IPS • length: 12" 	226651	56.45	Chrome	6
	226651BN	109.45	Brushed Nickel	6
	226651NL	109.45	Polished Nickel	6
	226651BG	109.45	Brushed Gold	6
	226651WR	120.35	Wrought Iron	6
	226651ORB	120.35	Oil Rubbed Bronze	6
 <ul style="list-style-type: none"> • connection: 1/2" IPS • length: 6" 	116651	18.25	Chrome	6
	116651BN	30.90	Brushed Nickel	6
	116651NL	30.90	Polished Nickel	6
	116651BG	30.90	Brushed Gold	6
	116651WR	40.15	Wrought Iron	6
	116651ORB	40.15	Oil Rubbed Bronze	6
 <ul style="list-style-type: none"> • connection: 1/2" IPS • length: 16" 	151380	93.50	Chrome	6
	151380BN	158.90	Brushed Nickel	6
	151380BG	158.90	Brushed Gold	6
	151380BL	174.70	Matte Black	6
	151380ORB	174.70	Oil Rubbed Bronze	6
	 <ul style="list-style-type: none"> • connection: 1/2" IPS • length: 8" 	123815	35.95	Chrome
123815BN		59.90	Brushed Nickel	12
123815NL		59.90	Polished Nickel	12
123815BG		59.90	Brushed Gold	12
123815BL		65.90	Matte Black	12
123815ORB		65.90	Oil Rubbed Bronze	12
 <ul style="list-style-type: none"> • connection: 1/2" IPS • length: 8" 	CL123815	46.05	Chrome	12
	CL123815BN	86.90	Brushed Nickel	12
 <ul style="list-style-type: none"> • connection: 1/2" IPS • length: 6" 	CL10154	36.80	Chrome	12
	CL10154BN	74.35	Brushed Nickel	12
 <ul style="list-style-type: none"> • connection: 1/2" IPS • length: 6" 	10154	26.45	Chrome	50
	10154BN	47.50	Brushed Nickel	50
	10154NL	47.50	Polished Nickel	1
	10154BG	47.50	Brushed Gold	30
	10154BRB	37.50	Mediterranean Bronze	20
	10154BL	44.85	Matte Black	30
	10154ORB	52.25	Oil Rubbed Bronze	50

CUSTOM SHOWERING

Shower Arms and Flanges



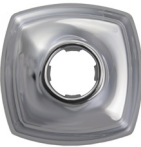
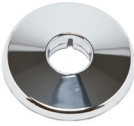

		MODEL	LIST	FINISH/CONNECT	CASE QTY
SHOWER ARM AND FLANGE - PREMIUM					
 <ul style="list-style-type: none"> • connection: 1/2" IPS • adjustable locking pivot points allow for increased range of articulating showerhead positions • short or long inlet arm can be installed to plumbed connection • length: 16" 		S116	181.80	Chrome	6
		S116BN	218.00	Brushed Nickel	6
		S116BG	218.00	Brushed Gold	6
		S116BL	239.80	Matte Black	6
		S116ORB	239.80	Oil Rubbed Bronze	6
 <ul style="list-style-type: none"> • connection: 1/2" IPS • length: 14" 		S110	167.40	Chrome	6
		S110BN	202.75	Brushed Nickel	6
		S110BG	202.75	Brushed Gold	6
		S110BL	222.85	Matte Black	6
		S110ORB	222.85	Oil Rubbed Bronze	6
 <ul style="list-style-type: none"> • connection: 1/2" IPS • length: 14" 		S113	167.40	Chrome	6
		S113BN	202.75	Brushed Nickel	6
		S113NL	202.75	Polished Nickel	3
		S113BG	202.75	Brushed Gold	6
		S113WR	222.85	Wrought Iron	3
	S113ORB	222.85	Oil Rubbed Bronze	6	
 <ul style="list-style-type: none"> • connection: 1/2" IPS • length: 8" 		S122	61.50	Chrome	6
		S122BN	127.05	Brushed Nickel	6
		S122NL	127.05	Polished Nickel	6
		S122BG	127.05	Brushed Gold	6
		S122BL	139.90	Matte Black	6
	S122ORB	139.90	Oil Rubbed Bronze	6	
 <ul style="list-style-type: none"> • connection: 1/2" IPS • length: 8" 		S134	61.50	Chrome	6
		S134BN	127.05	Brushed Nickel	6
		S134BG	127.05	Brushed Gold	6
		S134BL	139.90	Matte Black	6
 <ul style="list-style-type: none"> • connection: 1/2" IPS • length: 8" 		S133	61.50	Chrome	6
		S133BN	127.05	Brushed Nickel	6
		S133BG	127.05	Brushed Gold	6
		S133BL	139.90	Matte Black	6
 <ul style="list-style-type: none"> • connection: 1/2" IPS • length: 6" 		S177	61.35	Chrome	6
		S177BN	127.05	Brushed Nickel	6
SHOWER ARM AND FLANGE					
 <ul style="list-style-type: none"> • connection: 1/2" IPS • length: 8" 		161951	122.50	Chrome	12
		161951BN	165.70	Brushed Nickel	12
		161951NL	165.70	Polished Nickel	12
		161951BG	165.70	Brushed Gold	12
		161951BL	182.25	Matte Black	12
		161951ORB	182.25	Oil Rubbed Bronze	12
 <ul style="list-style-type: none"> • connection: 1/2" IPS • length: 8-3/4" 		177171	117.25	Chrome	12
		177171BN	158.55	Brushed Nickel	12
		177171NL	158.55	Polished Nickel	12
		177171ORB	174.45	Oil Rubbed Bronze	12
 <ul style="list-style-type: none"> • connection: 1/2" IPS • length: 6" 		A705	56.05	Chrome	12
		A705CBN	84.05	Classic Brushed Nickel	12

Shower Arms and Flanges

		MODEL	LIST	FINISH/CONNECT	CASE QTY
	<ul style="list-style-type: none"> • tub and shower accent kit 	AT2099	21.55	Chrome	12
		AT2099BN	54.80	Brushed Nickel	12
		AT2099ORB	60.20	Oil Rubbed Bronze	12
	<ul style="list-style-type: none"> • shower arm flange 	179834	17.85	Chrome	20
		179834BL	24.00	Matte Black	20
	<ul style="list-style-type: none"> • shower arm flange 	147572	15.60	Chrome	12
		147572BN	22.75	Brushed Nickel	12
		147572BG	22.75	Brushed Gold	12
		147572BL	27.10	Matte Black	12
	<ul style="list-style-type: none"> • shower arm flange 	164745	14.65	Chrome	20
		164745BN	21.40	Brushed Nickel	20
		164745NL	21.40	Polished Nickel	20
		164745BG	21.40	Brushed Gold	20
		164745ORB	27.80	Oil Rubbed Bronze	20
	<ul style="list-style-type: none"> • shower arm flange 	137488	10.85	Chrome	200
		137488BN	28.20	Brushed Nickel	200
		137488NL	28.20	Polished Nickel	48
		137488BG	28.20	Brushed Gold	12
		137488BL	29.75	Matte Black	24
	<ul style="list-style-type: none"> • shower arm flange 	AT2199	10.25	Chrome	200
		AT2199BN	27.00	Brushed Nickel	200
		AT2199NL	27.00	Polished Nickel	48
		AT2199BG	28.55	Brushed Gold	48
		AT2199WR	29.65	Wrought Iron	24
		AT2199ORB	29.65	Oil Rubbed Bronze	200

CUSTOM SHOWERING

Shower Rails

		MODEL	LIST	FINISH/CONNECT	CASE QTY
MOEN SPA SHOWER RAIL COMBO - PREMIUM					
	<ul style="list-style-type: none"> • connection: 1/2" IPS • showerhead: two-function standard with handshower • showerhead size: 7-3/4" diameter • type of function: atomized spray • includes: double check valves for backflow prevention • 23-1/2" wall bracket with 17" height range 	1.75 GPM (6.65 L/min) max.			
		N207C0CH	482.40	Chrome/White	2
		N207C0SRN	559.05	Spot Resist Brushed Nickel	2
		N207C0BLC	575.90	Matte Black/Chrome	2
		N207C0BL	669.35	Matte Black	2
MOEN SPA SHOWER RAIL - PREMIUM					
	<ul style="list-style-type: none"> • connection: 1/2" IPS • showerhead: single-function rainshower • showerhead size: 7-3/4" diameter • type of function: atomized spray • included: double check valves for backflow prevention • 23-1/2" wall bracket with 17" height range 	1.3 GPM (4.9 L/min) max.			
		N207R0CH	372.05	Chrome/White	2
		N207R0SRN	420.70	Spot Resist Brushed Nickel	2
		N207R0BLC	428.15	Matte Black/Chrome	2
		N207R0BL	484.25	Matte Black	2
MOEN SPA SHOWER RAIL HANDSHOWER & MAGNETIC DOCK - PREMIUM					
	<ul style="list-style-type: none"> • handshower: single-function • showerhead size: 2-1/2" diameter • type of function: atomized spray • hose length: 59" • compatability: only with Nebia shower rail 	0.4 gpm (1.5 L/m)			
		N207H0CH	110.30	Chrome/White	2
		N207H0SRN	138.40	Spot Resist Brushed Nickel	2
		N207H0BLC	147.75	Matte Black/Chrome	2
		N207H0BL	185.10	Matte Black	2
MOEN MAGNETIC DOCK - PREMIUM					
	<ul style="list-style-type: none"> • includes: magnetic docking system • compatability: only with Moen Spa Shower Magnetix Handhelds • includes: two installation options - permanent waterproof adhesive or wall bracket with screw 	N207Z0GLC	31.70	Glacier/Chrome	6
		N207Z0SRN	33.70	Spot Resist Brushed Nickel	6
		N207Z0BL	35.50	Matte Black	6
ANNEX™ SHOWER RAIL - PREMIUM					
	<ul style="list-style-type: none"> • connection: 1/2" IPS • showerhead: sold separately • handshower: sold separately • type of function: two independent functions • hose length: 59" 	TS3661NH	700.40	Chrome	3
		TS3661NHBN	1106.45	Brushed Nickel	3
		TS3661NHBG	1106.45	Brushed Gold	3
		TS3661NHORB	1167.50	Oil Rubbed Bronze	3
		TS3661NHBL	1167.50	Matte Black	3

	MODEL	LIST	FINISH/CONNECT	CASE QTY
--	-------	------	----------------	----------

HANDHELD WITH SLIDEBAR - PREMIUM



- handshower: single-function eco-performance
- showerhead size: 3-3/8" diameter
- type of function: full spray
- slide bar length: 30"
- hose length: 69"
- double check valve: included
- slide bar: not to be used as a grab bar
- drop ell: sold separately
- use secure mount anchor to meet hand grip requirements

1.75 GPM (6.65 L/min) max.				
S12107EP	711.80	Chrome		6
S12107EPBN	1006.60	Brushed Nickel		6
S12107EPNL	1006.60	Polished Nickel		6
S12107EPBG	1006.60	Brushed Gold		6
S12107EPBL	1117.70	Matte Black		6
S12107EPORB	1107.15	Oil Rubbed Bronze		6

DROP ELLS SOLD SEPARATELY

A725	66.10	Chrome		12
A725BN	93.60	Brushed Nickel		12
A725NL	93.60	Polished Nickel		12
A725BG	98.85	Brushed Gold		12
A725WR	102.90	Wrought Iron		12
A725ORB	102.90	Oil Rubbed Bronze		12

SECUREMOUNT™ ANCHORS SOLD SEPARATELY

A750	41.65	N/A or Unfinished		24
------	-------	-------------------	--	----



- handshower: four-function eco-performance
- showerhead size: 3-3/4" diameter
- type of function: soothe; drench; shine; immerse
- slide bar length: 30"
- hose length: 69"
- double check valve: included
- slide bar: not to be used as a grab bar
- drop ell: sold separately
- use secure mount anchor to meet hand grip requirements

1.75 GPM (6.65 L/min) max.				
S3870EPBN	982.55	Brushed Nickel		6

DROP ELLS SOLD SEPARATELY

A725BN	93.60	Brushed Nickel		12
--------	-------	----------------	--	----

SECUREMOUNT™ ANCHORS SOLD SEPARATELY

A750	41.65	N/A or Unfinished		24
------	-------	-------------------	--	----



- handshower: single-function eco-performance
- showerhead size: 3" diameter
- type of function: full spray
- slide bar length: 30"
- hose length: 69"
- double check valve: included
- slide bar: not to be used as a grab bar
- drop ell: sold separately
- use secure mount anchor to meet hand grip requirements

1.75 GPM (6.65 L/min) max.				
S3879EP	432.45	Chrome		6
S3879EPBN	867.70	Brushed Nickel		6

DROP ELLS SOLD SEPARATELY

A721	84.55	Chrome		12
A721BN	119.25	Brushed Nickel		12

SECUREMOUNT™ ANCHORS SOLD SEPARATELY

A750	41.65	N/A or Unfinished		24
------	-------	-------------------	--	----



- handshower: single-function eco-performance
- showerhead size: 1" diameter
- type of function: full spray
- slide bar length: 30"
- hose length: 69"
- double check valve: included
- slide bar: not to be used as a grab bar
- metal construction
- drop ell: sold separately
- use secure mount anchor to meet hand grip requirements

1.75 GPM (6.65 L/min) max.				
S3880EP	432.45	Chrome		6
S3880EPBN	867.70	Brushed Nickel		6
S3880EPNL	867.70	Polished Nickel		6
S3880EPBG	867.70	Brushed Gold		6

DROP ELLS SOLD SEPARATELY

A721	84.55	Chrome		12
A721BN	119.25	Brushed Nickel		12
A721NL	119.25	Polished Nickel		12
A721BG	119.25	Brushed Gold		12

SECUREMOUNT™ ANCHORS SOLD SEPARATELY

A750	41.65	N/A or Unfinished		24
------	-------	-------------------	--	----

HANDHELD WITH SLIDEBAR



- handshower: five-function eco-performance
- showerhead size: 4-1/2" diameter
- type of function: pause; wide coverage; downpour; massage; rinse; full spray
- slide bar length: 30"
- hose length: 69"
- double check valve: included
- slide bar: not to be used as a grab bar
- drop ell: sold separately
- ADA compliant: yes



1.75 GPM (6.65 L/min) max.				
3670EP	393.80	Chrome		6
3670EPBN	571.05	Brushed Nickel		6
3670EPBL	628.05	Matte Black		6

DROP ELLS SOLD SEPARATELY

A725	66.10	Chrome		12
A725BN	93.60	Brushed Nickel		12
A725WR	102.90	Wrought Iron		12

SECUREMOUNT™ ANCHORS SOLD SEPARATELY

A750	41.65	N/A or Unfinished		24
------	-------	-------------------	--	----

Handheld Showers

CUSTOM SHOWERING

HANDHELD WITH SLIDEBAR



- handshower: five-function eco-performance
- showerhead size: 4-1/2" diameter
- type of function: pause; wide coverage; downpour; massage; rinse; full spray
- slide bar length: 30"
- hose length: 69"
- double check valve: included
- slide bar: not to be used as a grab bar
- drop ell: sold separately
- ADA compliant: yes



MODEL LIST FINISH/CONNECT CASE QTY

1.75 GPM (6.65 L/min) max.

3671EP	393.80	Chrome	6
3671EPBN	571.05	Brushed Nickel	6
3671EPBL	628.05	Matte Black	6

DROP ELLS SOLD SEPARATELY

A725	66.10	Chrome	12
A725BN	93.60	Brushed Nickel	12
A725WR	102.90	Wrought Iron	12

SECUREMOUNT™ ANCHORS SOLD SEPARATELY

A750	41.65	N/A or Unfinished	24
------	-------	-------------------	----



- handshower: four-function eco-performance
- showerhead size: 4-3/8" diameter
- type of function: full spray; invigorating spray; combination; targeted massage
- slide bar length: 30"
- hose length: 69"
- double check valve: included
- slide bar: not to be used as a grab bar
- drop ell: sold separately
- use secure mount anchor: to meet hand grip requirements

1.75 GPM (6.65 L/min) max.

3667EP	351.55	Chrome	6
3667EPBN	695.05	Brushed Nickel	6
3667EPNL	695.05	Polished Nickel	6
3667EPBG	695.05	Brushed Gold	6
3667EPBL	764.55	Matte Black	6
3667EPORB	764.55	Oil Rubbed Bronze	6

DROP ELLS SOLD SEPARATELY

A725	66.10	Chrome	12
A725BN	93.60	Brushed Nickel	12
A725NL	93.60	Polished Nickel	12
A725BG	98.85	Brushed Gold	12
A725WR	102.90	Wrought Iron	12
A725ORB	102.90	Oil Rubbed Bronze	12

SECUREMOUNT™ ANCHORS SOLD SEPARATELY

A750	41.65	N/A or Unfinished	24
------	-------	-------------------	----



- handshower: four-function eco-performance
- showerhead size: 4" diameter
- type of function: full spray; invigorating spray; combination; targeted massage
- slide bar length: 30"
- hose length: 69"
- double check valve: included
- slide bar: not to be used as a grab bar
- drop ell: sold separately
- use secure mount anchor to meet hand grip requirements

1.75 GPM (6.65 L/min) max.

3669EP	351.55	Chrome	6
3669EPBN	695.05	Brushed Nickel	6
3669EPBL	764.55	Matte Black	6
3669EPORB	764.55	Oil Rubbed Bronze	6

DROP ELLS SOLD SEPARATELY

A725	66.10	Chrome	12
A725BN	93.60	Brushed Nickel	12
A725ORB	102.90	Oil Rubbed Bronze	12
A725WR	102.90	Wrought Iron	12

SECUREMOUNT™ ANCHORS SOLD SEPARATELY

A750	41.65	N/A or Unfinished	24
------	-------	-------------------	----



- handshower: single-function eco-performance
- showerhead size: 1-1/8" diameter
- type of function: full spray
- slide bar length: 30"
- hose length: 69"
- double check valve: included
- slide bar: not to be used as a grab bar
- drop ell: sold separately
- use secure mount anchor to meet hand grip requirements

1.75 GPM (6.65 L/min) max.

3887EP	359.15	Chrome	6
3887EPBN	713.70	Brushed Nickel	6
3887EPBG	713.70	Brushed Gold	6
3887EPBL	756.25	Matte Black	6

DROP ELLS SOLD SEPARATELY





A725	66.10	Chrome	12
A725BN	93.60	Brushed Nickel	12
A725BG	98.85	Brushed Gold	12
A725WR	102.90	Wrought Iron	12

SECUREMOUNT™ ANCHORS SOLD SEPARATELY

A750	41.65	N/A or Unfinished	24
------	-------	-------------------	----



Handheld Showers

CUSTOM SHOWERING

	MODEL	LIST	FINISH/CONNECT	CASE QTY	
HANDHELD WITH SLIDEBAR					
 <ul style="list-style-type: none"> • soft square handshower: single-function • showerhead size: 1-1/8" diameter • type of function: full spray • hose length: 69" • double check valve: included • slide bar: not to be used as a grab bar • drop ell: sold separately • use secure mount anchor to meet hand grip requirements 	1.75 GPM (6.65 L/min) max.				
	3988EP	326.50	Chrome	6	
	3988EPSRN	648.75	Spot Resist Brushed Nickel	6	
	3988EPBN	648.75	Brushed Nickel	6	
	DROP ELLS SOLD SEPARATELY				
	A721	84.55	Chrome	12	
	A721SRN	119.25	Spot Resist Brushed Nickel	12	
	A721BN	119.25	Brushed Nickel	12	
	SECUREMOUNT™ ANCHORS SOLD SEPARATELY				
	A750	41.65	N/A or Unfinished	24	
 <ul style="list-style-type: none"> • handshower: three-function eco-performance • showerhead size: 4" diameter • type of function: full spray; concentrated rinse; combination • slide bar length: 30" • hose length: 69" • double check valve: included • slide bar: not to be used as a grab bar • drop ell: sold separately • securemount anchor to meet hand grip requirements 	1.75 GPM (6.65 L/min) max.				
	3863EP	320.60	Chrome	6	
	3863EPBN	669.60	Brushed Nickel	6	
	DROP ELLS SOLD SEPARATELY				
	A725	66.10	Chrome	12	
	A725BN	93.60	Brushed Nickel	12	
	SECUREMOUNT™ ANCHORS SOLD SEPARATELY				
	A750	41.65	N/A or Unfinished	24	
	 <ul style="list-style-type: none"> • handshower: single-function eco-performance • showerhead size: 4-1/4" diameter • type of function: full spray • slide bar length: 24" • hose length: 59" • double check valve: included • slide bar: not to be used as a grab bar • drop ell: sold separately • use secure mount anchor to meet hand grip requirements 	1.75 GPM (6.65 L/min) max.			
		3668EP	294.30	Chrome	6
3668EPBN		425.95	Brushed Nickel	6	
3668EPORB		468.10	Oil Rubbed Bronze	6	
DROP ELLS SOLD SEPARATELY					
A725		66.10	Chrome	12	
A725BN		93.60	Brushed Nickel	12	
A725ORB		102.90	Oil Rubbed Bronze	12	
SECUREMOUNT™ ANCHORS SOLD SEPARATELY					
A750		41.65	N/A or Unfinished	24	
 <ul style="list-style-type: none"> • showerhead: single-function eco-performance • showerhead size: 4" diameter • type of function: full spray • slide bar length: 24" • hose length: 59" • double check valve: included • slide bar: not to be used as a grab bar • drop ell: sold separately • use secure mount anchor: to meet hand grip requirements 	1.75 GPM (6.65 L/min) max.				
	3868EP	294.30	Chrome	6	
	3868EPBN	425.95	Brushed Nickel	6	
	3868EPBG	425.95	Brushed Gold	6	
	3868EPORB	468.10	Oil Rubbed Bronze	6	
	DROP ELLS SOLD SEPARATELY				
	A725	66.10	Chrome	12	
	A725BN	93.60	Brushed Nickel	12	
	A725BG	98.85	Brushed Gold	12	
	A725ORB	102.90	Oil Rubbed Bronze	12	
SECUREMOUNT™ ANCHORS SOLD SEPARATELY					
A750	41.65	N/A or Unfinished	24		
 <ul style="list-style-type: none"> • handshower: five-function eco-performance • showerhead size: 4-3/8" diameter • type of function: full spray; downpour; relaxing massage; massage; rinse • slide bar length: 30" • hose length: 69" • double check valve: included • slide bar: not to be used as a grab bar • drop ell: sold separately • use secure mount anchor to meet hand grip requirements 	1.75 GPM (6.65 L/min) max.				
	3558EP	276.70	Chrome	6	
	3558EPBN	373.55	Brushed Nickel	6	
	3558EPBL	410.90	Matte Black	6	
	3558EPORB	410.90	Oil Rubbed Bronze	6	
	DROP ELLS SOLD SEPARATELY				
	A725	66.10	Chrome	12	
	A725BN	93.60	Brushed Nickel	12	
	A725WR	102.90	Wrought Iron	12	
	A725ORB	102.90	Oil Rubbed Bronze	12	
SECUREMOUNT™ ANCHORS SOLD SEPARATELY					
A750	41.65	N/A or Unfinished	24		

Handheld Showers

CUSTOM SHOWERING

		MODEL	LIST	FINISH/CONNECT	CASE QTY
HANDHELD WITH WALL BRACKET - PREMIUM					
	<ul style="list-style-type: none"> • handshower: single-function eco-performance • showerhead size: 1-1/8" diameter • type of function: full spray • hose length: 69" • wall bracket: included • double check valve: included • drop ell: sold separately 	1.75 GPM (6.65 L/min) max.			
		S11705EP	352.40	Chrome	6
		S11705EPBN	510.75	Brushed Nickel	6
DROP ELLS SOLD SEPARATELY					
		A725	66.10	Chrome	12
		A725BN	93.60	Brushed Nickel	12
HANDHELD WITH WALL BRACKET					
	<ul style="list-style-type: none"> • handshower: four-function eco-performance • showerhead size: 4-3/8" diameter • type of function: full spray; invigorating spray; combination; targeted massage • hose length: 69" • double check valve: included • drop ell: sold separately 	1.75 GPM (6.65 L/min) max.			
		3636EP	340.10	Chrome	6
		3636EPBN	647.15	Brushed Nickel	6
		3636EPBG	647.15	Brushed Gold	6
		3636EPBL	711.90	Matte Black	6
		3636EPORB	711.90	Oil Rubbed Bronze	6
DROP ELLS SOLD SEPARATELY					
		A725	66.10	Chrome	12
		A725BN	93.60	Brushed Nickel	12
		A725BG	98.85	Brushed Gold	12
		A725WR	102.90	Wrought Iron	12
		A725ORB	102.90	Oil Rubbed Bronze	12
	<ul style="list-style-type: none"> • handshower: single-function eco-performance • showerhead size: 4" diameter • type of function: full spray • hose length: 59" • wall bracket: included • double check valve: included • drop ell: sold separately 	1.75 GPM (6.65 L/min) max.			
		3865EP	244.65	Chrome	6
		3865EPBN	355.20	Brushed Nickel	6
		3865EPORB	390.95	Oil Rubbed Bronze	6
DROP ELLS SOLD SEPARATELY					
		A725	66.10	Chrome	12
		A725BN	93.60	Brushed Nickel	12
		A725ORB	102.90	Oil Rubbed Bronze	12

MOEN® X INLY™ AROMATHERAPY COLLECTION



- aromatherapy handshower: infuses essential oils directly into your shower water when desired
- showerhead functions: six spray settings and four aromatherapy dilution settings (high/med/low/off)
- showerhead size: 5.6" diameter
- type of function: wide coverage; intensify; downpour; relaxing massage; massage; rinse
- hose length: 60"
- includes: magnetix docking system
- double check valve: included
- arm and flange: sold separately
- INLY™ aromatherapy shower capsules sold separately

MODEL LIST FINISH/CONNECT CASE QTY

1.75 GPM (6.65 L/min) max.			
208H2	173.95	Chrome	2
208H2SRN	191.35	Spot Resist Brushed Nickel	2



- showerhead aromatherapy: rainshower and handshower infuses essential oils directly into your shower water when desired
- 3 showers in 1: use showerheads separately or together
- showerhead function: six spray settings and four aromatherapy dilution settings (high/med/low/off)
- showerhead size: 6-1/2" diameter
- handshower type of function: wide coverage; rinse; invigorating spray; relaxing massage; massage; downpour
- showerhead type: eco-performance
- hose length: 60"
- includes: magnetix docking system
- double check valve: included
- arm and flange: sold separately
- includes: 4 INLY™ shower capsules: 1 of each fragrance

1.75 GPM (6.65 L/min) max.			
IN208C2	323.00	Chrome	2
IN208C2SRN	339.25	Spot Resist Brushed Nickel	2

AROMATHERAPY CAPSULES



- INLY™ aromatherapy shower capsules 5-pack
- infuse the shower with 4 unique spa-inspired fragrance curated with essential oils
- dispense only using INLY compatible Moen® aromatherapy showering devices (sold separately)

INC20801	25.95	Energetic Morning™	6
INC20802	25.95	Tropical Day™	6
INC20803	25.95	Sweet Morning™	6
INC20804	25.95	Zen Time™	6

MODEL LIST FINISH/CONNECT CASE QTY

MAGNETIX® COMBINATION SHOWER



- Infiniti™ dial allows user to precisely adjust to preferred balance of force and coverage
- three-way diverter provides ability to flow each shower head separately or combined for more coverage
- pivoting rainshower tilts 20 degrees forward and 20 degrees backwards
- includes: Magnetix® docking system
- connection: 1/2" IPS
- showerhead size: 7" diameter
- handshower size: 5"
- includes: 72" metal hose



2.5 GPM (9.5 L/min) max.			
220C3	275.40	Chrome	2
220C3BN	358.00	Brushed Nickel	2
220C3BG	393.80	Brushed Gold	2
220C3BL	358.00	Matte Black	2
1.75 GPM (6.65 L/min) max.			
220C3EP	275.40	Chrome	2
220C3EPBN	358.00	Brushed Nickel	2
220C3EPBG	393.80	Brushed Gold	2
220C3EPBL	358.00	Matte Black	2

MAGNETIX® HANDHELDS - PREMIUM



- handshower: four-function eco-performance
- showerhead size: 6-1/2" diameter
- type of function: cleanse, relieve, soothe, and clarify
- engineered for optimal warmth, rinsing and body coverage
- offers a superior shower experience through atomization, the process of breaking up water into tiny droplets
- hose length: 72"
- double check valve: included
- includes: Magnetix® docking system

1.5 GPM (5.7 L/min) max.			
N400H0CH	245.60	Chrome	2
N400H0BN	318.30	Brushed Nickel	2
N400H0BG	318.30	Brushed Gold	2
N400H0BL	361.90	Matte Black	2
N400H0ORB	361.90	Oil Rubbed Bronze	2

MAGNETIX® HANDHELDS



- handshower: six-function eco-performance
- showerhead size: 5-1/2" diameter
- type of function: wide coverage; downpour; relaxing massage; massage; invigorating spray; rinse
- hose length: 59"
- double check valve: included
- includes: Magnetix® docking system

1.75 GPM (6.65 L/min) max.			
3662EP	228.85	Chrome	6
3662EPBN	310.25	Brushed Nickel	6
3662EPBG	310.25	Brushed Gold	6
3662EPBL	378.35	Matte Black	6
3662EPORB	390.35	Oil Rubbed Bronze	6



- handshower: six-function eco-performance
- showerhead size: 3-1/2" diameter
- type of function: wide coverage; downpour; relaxing massage; massage; soothing massage; rinse
- hose length: 60"
- includes: Magnetix® docking system
- double check valve: included
- arm and flange: sold separately

1.75 GPM (6.65 L/min) max.			
26100EP	69.80	Chrome	2
26100EPSRN	85.35	Spot Resist Brushed Nickel	2
26100EPBL	91.95	Matte Black	2



- handshower: six-function eco-performance
- showerhead size: 3-1/2" diameter
- type of function: wide coverage; downpour; relaxing massage; massage; soothing massage; rinse
- hose length: 60"
- includes: Magnetix® docking system
- double check valve: included
- arm and flange: sold separately
- pre-pack with corrugated display

1.75 GPM (6.65 L/min) max.			
P26100EP	69.80	Chrome	12



- handshower: six-function eco-performance
- showerhead size: 5-1/2" diameter
- type of function: wide coverage; downpour; relaxing massage; massage; soothing massage; rinse
- double check valve: included
- includes: Magnetix® docking system
- handshower only
- magnetic dock and hose sold separately

1.75 GPM (6.65 L/min) max.			
187054	161.35	Chrome	6
187054BN	201.15	Brushed Nickel	6
187054BG	193.05	Brushed Gold	6
187054BL	222.90	Matte Black	6
187054ORB	222.90	Oil Rubbed Bronze	6









MAGNETIX® HANDHELD DOCKS











- includes: Magnetix® docking system
- compatible with the following Magnetix SKUs only: 3662EP, 187054 and 26100EP
- includes two installation options: permanent waterproof adhesive or wall bracket with screws

186117	25.75	Chrome	6
186117SRN	31.30	Spot Resist Brushed Nickel	6
186117BN	38.70	Brushed Nickel	6
186117BL	41.55	Matte Black	6
186117ORB	42.60	Oil Rubbed Bronze	6







Handheld Showers

HANDHELD		MODEL	LIST	FINISH/CONNECT	CASE QTY
	<ul style="list-style-type: none"> • handshower: single-function eco-performance • showerhead size: 3-3/8" diameter • type of function: full spray • double check valve: included 	1.75 GPM (6.65 L/min) max.			
		154305	178.95	Chrome	6
		154305BN	259.50	Brushed Nickel	6
		154305NL	275.55	Polished Nickel	6
		154305BG	245.60	Brushed Gold	6
		154305BL	275.55	Matte Black	6
		154305ORB	275.55	Oil Rubbed Bronze	6
	<ul style="list-style-type: none"> • handshower: three-function eco-performance • showerhead size: 4" diameter • type of function: full spray; concentrated rinse; combination • double check valve: included 	1.75 GPM (6.65 L/min) max.			
		147913	175.60	Chrome	6
		147913BN	260.00	Brushed Nickel	6
	<ul style="list-style-type: none"> • handshower: four-function eco-performance • showerhead size: 3-3/4" diameter • type of function: full spray; invigorating spray; combination; targeted massage • double check valve: included 	1.75 GPM (6.65 L/min) max.			
		160042	127.65	Chrome	6
		160042BN	185.25	Brushed Nickel	6
		160042ORB	203.75	Oil Rubbed Bronze	6
	<ul style="list-style-type: none"> • handshower: single-function eco-performance • showerhead size: 3" diameter • type of function: full spray • double check valve: included 	1.75 GPM (6.65 L/min) max.			
		176257	120.10	Chrome	6
		176257BN	176.10	Brushed Nickel	6
	<ul style="list-style-type: none"> • handshower: single-function square • showerhead size: 1" diameter • type of function: full spray • double check valve: included • metal construction 	1.75 GPM (6.65 L/min) max.			
		189575	113.60	Chrome	6
		189575BN	166.65	Brushed Nickel	6
		189575NL	166.65	Polished Nickel	6
		189575BL	183.40	Matte Black	6
		189575BG	166.65	Brushed Gold	6
	<ul style="list-style-type: none"> • handshower: five-function eco-performance • showerhead size: 4-1/2" diameter • type of function: pause; wide coverage; downpour; massage; rinse; full spray • double check valve: included • valve: sold separately 	1.75 GPM (6.65 L/min) max.			
		198020	109.05	Chrome	6
		198020BN	158.10	Brushed Nickel	6
		198020BL	173.95	Matte Black	6
	<ul style="list-style-type: none"> • handshower: five-function eco-performance • showerhead size: 4-1/2" diameter • type of function: pause; wide coverage; downpour; massage; rinse; full spray • double check valve: included • valve: sold separately 	1.75 GPM (6.65 L/min) max.			
		198021	109.05	Chrome	6
		198021BN	158.10	Brushed Nickel	6
		198021BL	173.95	Matte Black	6
	<ul style="list-style-type: none"> • handshower: four-function eco-performance • showerhead size: 4" diameter • type of function: full spray; invigorating spray; combination; targeted massage • double check valve: included 	1.75 GPM (6.65 L/min) max.			
		164928	99.10	Chrome	6
		164928BN	143.65	Brushed Nickel	6
		164928BL	158.05	Matte Black	6
		164928ORB	158.05	Oil Rubbed Bronze	6
	<ul style="list-style-type: none"> • handshower: four-function eco-performance • showerhead size: 4" diameter • type of function: full spray; invigorating spray; combination; targeted massage • double check valve: included • carded packaging: yes 	1.75 GPM (6.65 L/min) max.			
		CL164928	93.80	Chrome	6
		CL164928BN	136.05	Brushed Nickel	6
	<ul style="list-style-type: none"> • handshower: four-function eco-performance • showerhead size: 4-3/8" diameter • type of function: full spray; invigorating spray; combination; targeted massage • double check valve: included 	1.75 GPM (6.65 L/min) max.			
		164927	96.70	Chrome	6
		164927BN	140.10	Brushed Nickel	6
		164927NL	132.50	Polished Nickel	6
		164927BG	118.00	Brushed Gold	6
		164927BL	141.75	Matte Black	6
		164927ORB	158.05	Oil Rubbed Bronze	6

Handheld Showers





		MODEL	LIST	FINISH/CONNECT	CASE QTY
HANDHELD					
	<ul style="list-style-type: none"> • handshower: single-function eco-performance • showerhead size: 1" diameter • type of function: full spray • double check valve: included 	1.75 GPM (6.65 L/min) max.			
		195957	75.70	Chrome	
		195957BN	109.80	Brushed Nickel	
		195957NL	109.80	Polished Nickel	
		195957ORB	120.90	Oil Rubbed Bronze	
	<ul style="list-style-type: none"> • handshower: single-function eco-performance • showerhead size: 1" diameter • type of function: full spray • double check valve: included 	1.75 GPM (6.65 L/min) max.			
		195958	78.55	Chrome	6
		195958BN	113.90	Brushed Nickel	6
		195958NL	113.90	Polished Nickel	6
		195958ORB	125.05	Oil Rubbed Bronze	6
	<ul style="list-style-type: none"> • handshower: single-function eco-performance • showerhead size: 4" diameter • type of function: full spray • double check valve: included 	1.75 GPM (6.65 L/min) max.			
		155747	83.00	Chrome	6
		155747BN	120.40	Brushed Nickel	6
		155747NL	153.75	Polished Nickel	6
		155747BG	109.10	Brushed Gold	6
		155747ORB	132.50	Oil Rubbed Bronze	6
	<ul style="list-style-type: none"> • handshower: single-function eco-performance round • showerhead size: 1-1/8" diameter • type of function: full spray • double check valve: included 	1.75 GPM (6.65 L/min) max.			
		155891	83.00	Chrome	24
		155891BN	115.35	Brushed Nickel	24
		155891BG	115.35	Brushed Gold	6
		155891BL	132.50	Matte Black	24
	<ul style="list-style-type: none"> • handshower: single-function eco-performance • showerhead size: 4" diameter • type of function: full spray • double check valve: included 	1.5 GPM (5.7 L/min) max.			
		157276EP15	83.00	Chrome	6
	<ul style="list-style-type: none"> • handshower: single-function eco-performance • showerhead size: 4" diameter • type of function: full spray • double check valve: included 	1.75 GPM (6.65 L/min) max.			
		164929	83.00	Chrome	6
		164929BN	120.40	Brushed Nickel	6
		164929NL	120.10	Polished Nickel	6
		164929ORB	132.50	Oil Rubbed Bronze	6
	<ul style="list-style-type: none"> • handshower: single-function eco-performance • showerhead size: 4" diameter • type of function: full spray • double check valve: included • carded packaging: yes 	1.75 GPM (6.65 L/min) max.			
		CL155747	78.55	Chrome	6
		CL155747BN	113.90	Brushed Nickel	6
	<ul style="list-style-type: none"> • handshower: single-function eco-performance soft square • showerhead size: 1-1/8" diameter • type of function: full spray • double check valve: included 	1.75 GPM (6.65 L/min) max.			
		189318	78.55	Chrome	6
		189318SRN	113.90	Spot Resist Brushed Nickel	6
		189318BN	113.90	Brushed Nickel	6
		189318BRB	125.45	Mediterranean Bronze	6
		189318ORB	125.45	Oil Rubbed Bronze	6
	<ul style="list-style-type: none"> • handshower: five-function eco-performance • showerhead size: 4-3/8" diameter • type of function: full spray; downpour; relaxing massage; massage; rinse • double check valve: included 	1.75 GPM (6.65 L/min) max.			
		189315	70.55	Chrome	6
		189315BN	95.25	Brushed Nickel	6
		189315BL	104.85	Matte Black	6
		189315ORB	104.85	Oil Rubbed Bronze	6

Body Sprays





	MODEL	LIST	FINISH/CONNECT	CASE QTY
PIVOTING BODY SPRAYS - PREMIUM				
 <ul style="list-style-type: none"> • spray functions: two-function • showerhead type: standard • showerhead size: 3-1/4" diameter • type of function: full spray, target massage • 1" extension kit available: 155656 • valve: sold separately 	2.0 GPM (7.6 L/min) max.			
	TS1420	302.05	Chrome	6
	TS1420BN	409.30	Brushed Nickel	6
	TS1420NL	409.30	Polished Nickel	6
	TS1420ORB	450.35	Oil Rubbed Bronze	6
 <ul style="list-style-type: none"> • spray functions: two-function • showerhead type: standard • showerhead size: 3-1/4" diameter • type of function: full spray, target massage • 1" extension kit available: 155656 • valve: sold separately 	2.0 GPM (7.6 L/min) max.			
	TS1422	302.05	Chrome	6
	TS1422BN	409.30	Brushed Nickel	6
	TS1422NL	409.30	Polished Nickel	6
	TS1422BG	409.30	Brushed Gold	6
	TS1422BL	450.35	Matte Black	6
TS1422ORB	450.35	Oil Rubbed Bronze	6	
 <ul style="list-style-type: none"> • spray functions: one-function • showerhead type: standard • showerhead size: 3-1/4" diameter • 1" extension kit available: 155656 • valve: sold separately 	2.0 GPM (7.6 L/min) max.			
	TS1320	195.15	Chrome	6
	TS1320BN	275.15	Brushed Nickel	6
	TS1320NL	275.15	Polished Nickel	6
	TS1320ORB	310.60	Oil Rubbed Bronze	6
 <ul style="list-style-type: none"> • spray functions: one-function • showerhead type: standard • showerhead size: 3-1/4" diameter • 1" extension kit available: 155656 • valve: sold separately 	2.0 GPM (7.6 L/min) max.			
	TS1322	195.15	Chrome	6
	TS1322BN	275.15	Brushed Nickel	6
	TS1322NL	275.15	Polished Nickel	6
	TS1322BG	275.15	Brushed Gold	6
	TS1322BL	310.60	Matte Black	6
TS1322ORB	310.60	Oil Rubbed Bronze	6	
FLUSHMOUNT BODY SPRAY VALVE - PREMIUM				
 <ul style="list-style-type: none"> • description: flushmount body spray valve • installation: fits standard 2x4 wall 	S1300	124.00	N/A or Unfinished	6
	BODY SPRAYS			
 <ul style="list-style-type: none"> • connection: 1/2" IPS • spray functions: one-function • showerhead size: 2" diameter 	1.75 GPM (6.65 L/min) max.			
	A501	122.70	Chrome	12
	A501BN	153.45	Brushed Nickel	12
	A501NL	153.45	Polished Nickel	12
	A501WR	168.75	Wrought Iron	12
	A501ORB	168.75	Oil Rubbed Bronze	12

CUSTOM SHOWERING

Showering Accessories





		MODEL	LIST	FINISH/CONNECT	CASE QTY		
SLIDEBAR							
	<ul style="list-style-type: none"> length: 30" slide bar: not to be used as a grab bar use SecureMount® anchors to meet handgrip requirement 	154296	364.50	Chrome	6		
		154296BN	400.80	Brushed Nickel	6		
		154296NL	440.90	Polished Nickel	6		
		154296BG	379.40	Brushed Gold	6		
		154296BL	440.90	Matte Black	6		
		154296ORB	440.90	Oil Rubbed Bronze	6		
		SECUREMOUNT™ ANCHORS SOLD SEPARATELY					
A750	41.65	N/A or Unfinished	24				
	<ul style="list-style-type: none"> length: 24" slide bar: not to be used as a grab bar use SecureMount® anchors to meet handgrip requirement 	155746	258.80	Chrome	6		
		155746BN	375.15	Brushed Nickel	6		
		155746BG	357.25	Brushed Gold	6		
		155746ORB	412.70	Oil Rubbed Bronze	6		
		SECUREMOUNT™ ANCHORS SOLD SEPARATELY					
		A750	41.65	N/A or Unfinished	24		
			<ul style="list-style-type: none"> length: 30" slide bar: not to be used as a grab bar use SecureMount® anchors to meet handgrip requirement 	A742	225.65	Chrome	6
A742BN	327.35			Brushed Nickel	6		
A742NL	309.60			Polished Nickel	6		
A742BG	290.10			Brushed Gold	6		
A742BRB	360.10			Mediterranean Bronze	6		
A742BL	360.10			Matte Black	6		
A742ORB	360.10			Oil Rubbed Bronze	6		
SECUREMOUNT™ ANCHORS SOLD SEPARATELY							
A750	41.65	N/A or Unfinished	24				
	<ul style="list-style-type: none"> length: 30" slide bar: not to be used as a grab bar use SecureMount® anchors to meet handgrip requirement 	A735	208.70	Chrome	6		
		A735BN	302.60	Brushed Nickel	6		
		A735NL	296.85	Polished Nickel	6		
		A735BG	270.85	Brushed Gold	6		
		A735WR	321.15	Wrought Iron	6		
		A735ORB	321.15	Oil Rubbed Bronze	6		
		SECUREMOUNT™ ANCHORS SOLD SEPARATELY					
A750	41.65	N/A or Unfinished	24				
	<ul style="list-style-type: none"> length: 30" slide bar: not to be used as a grab bar use SecureMount® anchors to meet handgrip requirement 	198017	99.05	Chrome	6		
		198017BN	143.60	Brushed Nickel	6		
		198017BL	152.50	Matte Black	6		
		SECUREMOUNT™ ANCHORS SOLD SEPARATELY					
A750	41.65	N/A or Unfinished	24				





Showering Accessories

HANDHELD SHOWER HOSE		MODEL	LIST	FINISH/CONNECT	CASE QTY
	<ul style="list-style-type: none"> • connection: 1/2" IPS • hose length: 59" • metal construction: yes • use brown (BR) for oil rubbed bronze (ORB) and mediterranean bronze (BRB) 	155748	49.60	Chrome	8
		155748BN	71.90	Brushed Nickel	8
		155748NL	48.65	Polished Nickel	8
		155748BG	48.65	Brushed Gold	8
		155748BR	106.00	Brown	8
		155748BL	106.00	Matte Black	8
	<ul style="list-style-type: none"> • connection: 1/2" IPS • hose length: 59" • metal construction: yes 	CL155748	46.90	Chrome	12
		CL155748BN	68.05	Brushed Nickel	12
	<ul style="list-style-type: none"> • connection: 1/2" IPS • hose length: 69" • metal construction: yes • use brown (BR) for oil rubbed bronze (ORB) and mediterranean bronze (BRB) • use satine (ST) for brushed nickel (BN) 	A726	134.25	Chrome	12
		A726SRN	239.80	Spot Resist Brushed Nickel	12
		A726NL	239.80	Polished Nickel	24
		A726BG	239.80	Brushed Gold	12
		A726BR	248.50	Brown	12
		A726WR	152.95	Wrought Iron	6
A726ST	239.80	Satine	12		
	<ul style="list-style-type: none"> • connection: 1/2" IPS • hose length: 72" • metal construction: yes 	210007	59.65	Chrome	12
		210007SRN	83.05	Spot Resist Brushed Nickel	12
		210007BN	83.05	Brushed Nickel	12
		210007BG	122.45	Brushed Gold	12
		210007BL	122.45	Matte Black	12
		210007ORB	122.45	Oil Rubbed Bronze	12
	<ul style="list-style-type: none"> • connection: 1/2" IPS • hose length: 80" • metal construction: yes 	A780	158.35	Chrome	20





CUSTOM SHOWERING

Showering Accessories

		MODEL	LIST	FINISH/CONNECT	CASE QTY
TWIN ELL					
	<ul style="list-style-type: none"> • connection size: 1/2" x 1/2" x 3/4" • connection type: IPS • description: twin ell • usage: with tub/shower installations where needed 	128284	36.25	N/A or Unfinished	12
DROP ELL					
	<ul style="list-style-type: none"> • connection: 1/2" IPS • integral handshower cradle: included 	A755	169.00	Chrome	12
		A755BN	245.15	Brushed Nickel	12
		A755BG	245.15	Brushed Gold	12
		A755BL	269.70	Matte Black	12
		A755ORB	269.70	Oil Rubbed Bronze	12
	<ul style="list-style-type: none"> • description: drop ell • connection: 1/2" IPS 	A721	84.55	Chrome	12
		A721SRN	119.25	Spot Resist Brushed Nickel	12
		A721BN	119.25	Brushed Nickel	12
		A721NL	119.25	Polished Nickel	12
		A721BG	119.25	Brushed Gold	12
		A721BL	131.15	Matte Black	12
		A721ORB	131.15	Oil Rubbed Bronze	12
	<ul style="list-style-type: none"> • description: drop ell • connection: 1/2" IPS 	A725	66.10	Chrome	12
		A725BN	93.60	Brushed Nickel	12
		A725NL	93.60	Polished Nickel	12
		A725BG	98.85	Brushed Gold	12
		A725ORB	102.90	Oil Rubbed Bronze	12
		A725WR	102.90	Wrought Iron	12
SECUREMOUNT™ FOR GRAB BARS					
	<ul style="list-style-type: none"> • description: SecureMount® anchors • use SecureMount® anchors to meet handgrip requirement 	A750	41.65	N/A or Unfinished	24

		MODEL	LIST	FINISH/CONNECT	CASE QTY
WALL BRACKET					
	<ul style="list-style-type: none"> • integral handshower cradle: included • metal construction: yes 	114348	115.35	Chrome	12
		114348BN	167.25	Brushed Nickel	12
		114348NL	134.15	Polished Nickel	12
		114348WR	183.85	Wrought Iron	12
		114348ORB	183.85	Oil Rubbed Bronze	12
	<ul style="list-style-type: none"> • integral handshower cradle: included 	155694	32.05	Chrome	12
		155694BN	46.35	Brushed Nickel	12
		155694BG	46.35	Brushed Gold	12
		155694BL	51.00	Matte Black	12
		155694ORB	51.00	Oil Rubbed Bronze	12
	<ul style="list-style-type: none"> • integral handshower cradle: included 	CL155694	30.35	Chrome	12
		CL155694BN	43.85	Brushed Nickel	12
MAGNETIX® HANDHELD DOCKS					
	<ul style="list-style-type: none"> • includes: Magnetix® docking system • compatible with the following Magnetix SKUs only: 3662EP, 187054 and 26100EP • includes two installation options: permanent waterproof adhesive or wall bracket with screws 	186117	25.75	Chrome	6
		186117SRN	31.30	Spot Resist Brushed Nickel	6
		186117BN	38.70	Brushed Nickel	6
		186117BL	41.55	Matte Black	6
		186117ORB	42.60	Oil Rubbed Bronze	6
VACUUM BREAKER					
	<ul style="list-style-type: none"> • connection: 1/2" IPS 	A714	56.15	Chrome	24
		A714ORB	89.50	Oil Rubbed Bronze	12
		A714WR	89.50	Wrought Iron	12

Showering Accessories







		MODEL	LIST	FINISH/CONNECT	CASE QTY
SHOWER ARM DIVERTER					
	<ul style="list-style-type: none"> • connection: 1/2" IPS • type of function: two independent 1 shared • integral handshower cradle: included • metal construction • carded packaging: yes 	CL707	142.50	Chrome	12
		CL707BN	206.55	Brushed Nickel	12
		CL707BL	227.25	Matte Black	12
		CL707ORB	227.25	Oil Rubbed Bronze	12
	<ul style="list-style-type: none"> • connection: 1/2" IPS • type of function: two independent 1 shared • metal construction • carded packaging: yes 	CL703	104.95	Chrome	12
		CL703BN	152.10	Brushed Nickel	12
		CL703BL	167.40	Matte Black	12
		CL703ORB	167.40	Oil Rubbed Bronze	12
	<ul style="list-style-type: none"> • connection: 1/2" IPS • type of function: two discrete • metal construction 	A720	94.30	Chrome	12
		A720BN	128.15	Brushed Nickel	12
		A720BL	140.95	Matte Black	12
		A720ORB	140.95	Oil Rubbed Bronze	12
	<ul style="list-style-type: none"> • connection: 1/2" IPS • integral handshower cradle: included • metal construction: yes 	A701	61.60	Chrome	12
		A701BN	89.10	Brushed Nickel	12
		A701BG	89.10	Brushed Gold	12
		A701BL	98.05	Matte Black	12
		A701ORB	98.05	Oil Rubbed Bronze	12
	<ul style="list-style-type: none"> • connection: 1/2" IPS • integral handshower cradle: included • metal construction: yes 	CLA701	61.60	Chrome	12
		CLA701BN	89.10	Brushed Nickel	12

Diverter Tub Spouts

		MODEL	LIST	FINISH/CONNECT	CASE QTY
DIVERGING TUB SPOUT - PREMIUM					
	<ul style="list-style-type: none"> • matches Weymouth® collection • connection: 1/2" slip fit • tub spout length: 6-3/4" • tub spout type: diverter 	S12104	219.30	Chrome	6
		S12104BN	347.35	Brushed Nickel	6
		S12104NL	350.85	Polished Nickel	6
		S12104BG	347.35	Brushed Gold	6
		S12104BL	382.10	Matte Black	6
		S12104ORB	382.10	Oil Rubbed Bronze	6
	<ul style="list-style-type: none"> • matches Flara™ collection • connection: 1/2" slip fit • tub spout length: 8-1/8" • tub spout type: diverter 	S989	279.70	Chrome	6
		S989BN	419.60	Brushed Nickel	6
		S989NL	419.60	Polished Nickel	6
		S989BG	419.60	Brushed Gold	6
	<ul style="list-style-type: none"> • matches Colinet™ collection • connection: 1/2" slip fit • tub spout length: 9" • tub spout type: diverter 	S5000	261.50	Chrome	6
		S5000BN	392.20	Brushed Nickel	6
		S5000BG	392.20	Brushed Gold	6
		S5000BL	431.35	Matte Black	6
	<ul style="list-style-type: none"> • matches 90 Degree™ collection • connection: 1/2" slip fit • tub spout length: 7-1/4" • tub spout type: diverter 	S3896	138.40	Chrome	6
		S3896BN	200.70	Brushed Nickel	6
		Q3 NEW! S3896BL	207.55	Matte Black	6
	<ul style="list-style-type: none"> • matches 90 Degree™ collection • connection: 1/2" IPS • tub spout length: 7-1/4" • tub spout type: diverter 	S3894	144.60	Chrome	6
	<ul style="list-style-type: none"> • matches Doux™ collection • connection: 1/2" slip fit • tub spout length: 7-3/4" • tub spout type: diverter 	S3835	169.15	Chrome	6
		S3835BN	245.25	Brushed Nickel	6
		S3835BL	269.85	Matte Black	6
DIVERGING TUB SPOUT					
	<ul style="list-style-type: none"> • matches Greenfield™ collection • connection: 1/2" slip fit • tub spout length: 7-3/8" • tub spout type: diverter 	NEW! Q3 4325	97.00	Chrome	6
		4325BN	153.70	Brushed Nickel	6
		4325BG	147.35	Brushed Gold	6
		4325BL	172.85	Matte Black	6
	<ul style="list-style-type: none"> • matches Cia™ collection • connection: 1/2" slip fit • tub spout length: 7-1/4" • tub spout type: diverter 	3346	89.90	Chrome	6
		3346BN	142.45	Brushed Nickel	6
		3346BG	142.45	Brushed Gold	6
		3346BL	165.85	Matte Black	6
	<ul style="list-style-type: none"> • matches Arris® collection • connection: 1/2" slip fit • tub spout length: 7-1/8" • tub spout type: diverter 	165914	193.00	Chrome	6
		165914BN	327.20	Brushed Nickel	6
		165914BL	359.95	Matte Black	6
	<ul style="list-style-type: none"> • matches Belfield® collection • connection: 1/2" slip fit • tub spout length: 7-3/4" • tub spout type: diverter 	185820	119.45	Chrome	6
		185820BN	142.55	Brushed Nickel	6
		185820NL	142.55	Polished Nickel	6
		Q3 NEW! 185820BL	149.30	Matte Black	6
		185820ORB	151.75	Oil Rubbed Bronze	6

Diverter Tub Spouts

		MODEL	LIST	FINISH/CONNECT	CASE QTY
	<ul style="list-style-type: none"> • matches Glyde™ collection • connection: 1/2" slip fit • tub spout length: 6" • tub spout type: diverter 	179791	121.75	Chrome	6
		179791BN	154.90	Brushed Nickel	6
		179791BL	170.40	Matte Black	6
	<ul style="list-style-type: none"> • matches Brantford® collection • connection: 1/2" IPS • tub spout length: 7-1/4" • tub spout type: diverter 	3814	104.95	Chrome	6
		3814BN	152.30	Brushed Nickel	6
		3814ORB	167.60	Oil Rubbed Bronze	6
	<ul style="list-style-type: none"> • matches Brantford® collection • connection: 1/2" slip fit • tub spout length: 7-1/4" • tub spout type: diverter 	3857	103.05	Chrome	6
		3857BN	149.55	Brushed Nickel	6
		3857ORB	164.50	Oil Rubbed Bronze	6
	<ul style="list-style-type: none"> • connection: 1/2" IPS • tub spout length: 5" • tub spout type: diverter 	3806	105.90	Chrome	12
	<ul style="list-style-type: none"> • matches Dartmoor® collection • connection: 1/2" slip fit • tub spout length: 7-3/8" • tub spout type: diverter 	3737	102.30	Chrome	6
		3737BN	148.50	Brushed Nickel	6
		3737BL	163.35	Matte Black	6
		3737ORB	163.35	Oil Rubbed Bronze	6
	<ul style="list-style-type: none"> • matches Voss™ collection • connection: 1/2" slip fit • tub spout length: 7-3/4" • tub spout type: diverter 	161955	101.40	Chrome	6
		161955BN	157.15	Brushed Nickel	6
		161955NL	157.15	Polished Nickel	6
		161955BG	157.15	Brushed Gold	6
		Q3 NEW! 161955BL	162.20	Matte Black	6
		161955ORB	172.90	Oil Rubbed Bronze	6
	<ul style="list-style-type: none"> • matches Wynford® collection • connection: 1/2" slip fit • tub spout length: 8" • tub spout type: diverter 	175385	100.75	Chrome	6
		175385BN	156.40	Brushed Nickel	6
		175385NL	156.40	Polished Nickel	6
		175385ORB	171.95	Oil Rubbed Bronze	6
	<ul style="list-style-type: none"> • matches Align® collection • connection: 1/2" slip fit • tub spout length: 7-1/8" • tub spout type: diverter 	172656	96.10	Chrome	6
		172656BN	152.30	Brushed Nickel	6
		172656BG	145.95	Brushed Gold	6
		172656BL	172.85	Matte Black	6
	<ul style="list-style-type: none"> • matches Align® collection • connection: 1/2" IPS • tub spout length: 7-1/8" • tub spout type: diverter 	172657	96.10	Chrome	6
		172657BN	152.30	Brushed Nickel	6
		172657BG	129.55	Brushed Gold	6
		172657BL	188.50	Matte Black	6
	<ul style="list-style-type: none"> • matches Gibson™ collection • connection: 1/2" CC • tub spout length: 6-1/2" • tub spout type: diverter 	3890	97.15	Chrome	12
		3890BN	141.05	Brushed Nickel	12
		3890BL	148.40	Matte Black	12

		MODEL	LIST	FINISH/CONNECT	CASE QTY
DIVERGING TUB SPOUT					
	<ul style="list-style-type: none"> • connection: 1/2" IPS • tub spout length: 5-1/2" • tub spout type: diverter 	3800	84.90	Chrome	12
	<ul style="list-style-type: none"> • connection: 1/2" slip fit • tub spout length: 5-1/2" • tub spout type: diverter 	3801	84.90	Chrome	12
	<ul style="list-style-type: none"> • connection: 1/2" IPS • tub spout length: 5-1/2" • tub spout type: diverter 	3911	72.95	Chrome	12
	<ul style="list-style-type: none"> • connection: 1/2" slip fit • tub spout length: 5-1/2" • tub spout type: diverter 	3960	72.95	Chrome	12
	<ul style="list-style-type: none"> • matches Eva® collection • connection: 1/2" slip fit • tub spout length: 7" • tub spout type: diverter 	3853	74.80	Chrome	12
		3853BN	155.20	Brushed Nickel	12
		3853BRB	115.15	Mediterranean Bronze	12
		3853ORB	170.70	Oil Rubbed Bronze	12
	<ul style="list-style-type: none"> • matched Genta™ LX collection • connection: 1/2" slip fit • tub spout length: 7" • tub spout type: diverter • drain size: 3-1/2" 	3839	73.15	Chrome	12
		3839BN	106.15	Brushed Nickel	1
		3839BL	116.65	Matte Black	12
	<ul style="list-style-type: none"> • connection: 1/2" IPS • tub spout length: 5-1/2" • tub spout type: diverter 	3926	70.95	Chrome	12
	<ul style="list-style-type: none"> • connection: 1/2" slip fit • tub spout length: 5-1/2" • tub spout type: diverter 	3931	70.95	Chrome	12

Non-Diverter Tub Spouts

		MODEL	LIST	FINISH/CONNECT	CASE QTY
NON-DIVERTING TUB SPOUT - PREMIUM					
	<ul style="list-style-type: none"> • matches Weymouth® collection • connection: 1/2" slip fit • tub spout length: 6-3/4" • tub spout type: non diverter 	S12105	197.45	Chrome	6
		S12105BN	286.30	Brushed Nickel	6
		S12105NL	286.30	Polished Nickel	6
		S12105BG	286.30	Brushed Gold	6
		S12105BL	314.95	Matte Black	6
		S12105ORB	314.95	Oil Rubbed Bronze	6
	<ul style="list-style-type: none"> • matches Flara™ collection • connection: 1/2" slip fit • tub spout length: 8-1/8" • tub spout type: non diverter 	S990	275.15	Chrome	6
		S990BN	412.75	Brushed Nickel	6
		S990NL	412.75	Polished Nickel	6
		S990BG	412.75	Brushed Gold	6
	<ul style="list-style-type: none"> • matched Colinet™ collection • connection: 1/2" slip fit • tub spout length: 9" • tub spout type: non diverter 	S5001	244.65	Chrome	6
		S5001BN	366.95	Brushed Nickel	6
		S5001BG	366.95	Brushed Gold	6
		S5001BL	403.65	Matte Black	6
	<ul style="list-style-type: none"> • matches Arris® collection • connection: 1/2" slip fit • tub spout length: 7-1/8" • tub spout type: non diverter 	S16900	185.40	Chrome	6
		S16900BN	314.40	Brushed Nickel	6
		S16900BL	345.95	Matte Black	6
	<ul style="list-style-type: none"> • matches Doux™ collection • connection: 1/2" slip fit • tub spout length: 7-3/4" • tub spout type: non diverter 	S3836	152.35	Chrome	6
		S3836BN	220.90	Brushed Nickel	6
		S3836BL	242.90	Matte Black	6
	<ul style="list-style-type: none"> • matches 90 Degree™ collection • connection: 1/2" slip fit • tub spout length: 7-1/4" • tub spout type: non diverter 	S3898	136.15	Chrome	6
		S3898BN	197.50	Brushed Nickel	6
		Q3 NEW! S3898BL	197.40	Matte Black	6
NON-DIVERTING TUB SPOUT					
	<ul style="list-style-type: none"> • matches Greenfield™ collection • connection: 1/2" slip fit • tub spout length: 7-3/8" • tub spout type: non diverter 	NEW! Q3 4326	78.35	Chrome	6
		4326BN	121.05	Brushed Nickel	6
		4326BG	121.05	Brushed Gold	6
		4326BL	133.20	Matte Black	6
	<ul style="list-style-type: none"> • matches Cia™ collection • connection: 1/2" slip fit • tub spout length: 7-1/4" • tub spout type: non diverter 	3347	75.25	Chrome	6
		3347BN	116.15	Brushed Nickel	6
		3347BG	116.15	Brushed Gold	6
		3347BL	127.75	Matte Black	6
	<ul style="list-style-type: none"> • matches Dartmoor® collection • connection: 1/2" slip fit • tub spout length: 7-1/4" • tub spout type: non diverter 	3858	92.45	Chrome	6
		3858BN	134.25	Brushed Nickel	6
		3858BL	147.70	Matte Black	6
		3858ORB	147.70	Oil Rubbed Bronze	6
	<ul style="list-style-type: none"> • matches Voss™ collection • connection: 1/2" slip fit • tub spout length: 7-3/4" • tub spout type: non diverter 	191956	94.15	Chrome	6
		191956BN	136.45	Brushed Nickel	6
		191956NL	136.45	Polished Nickel	6
		191956BG	136.45	Brushed Gold	6
		Q3 NEW! 191956BL	141.25	Matte Black	6
		191956ORB	150.00	Oil Rubbed Bronze	6

Non-Diverter Tub Spouts

NON-DIVERTING TUB SPOUT		MODEL	LIST	FINISH/CONNECT	CASE QTY
	<ul style="list-style-type: none"> • matches Wynford® collection • connection: 1/2" slip fit • tub spout length: 8" • tub spout type: non diverter 	195386	93.50	Chrome	6
		195386BN	135.65	Brushed Nickel	6
		195386NL	135.65	Polished Nickel	6
		195386ORB	149.25	Oil Rubbed Bronze	6
	<ul style="list-style-type: none"> • matches Belfield® collection • connection: 1/2" slip fit • tub spout length: 7-3/4" • tub spout type: non diverter 	193371	78.35	Chrome	6
		193371BN	121.05	Brushed Nickel	6
		Q3 NEW! 193371BL	125.40	Matte Black	6
		193371ORB	133.20	Oil Rubbed Bronze	6
	<ul style="list-style-type: none"> • matches Gibson™ collection • connection: 1/2" slip fit • tub spout length: 6-1/2" • tub spout type: non diverter 	3892	79.35	Chrome	12
		3892BN	122.50	Brushed Nickel	12
		3892BG	122.50	Brushed Gold	6
		3892BL	130.70	Matte Black	6
	<ul style="list-style-type: none"> • matches Align® collection • connection: 1/2" slip fit • tub spout length: 7-1/8" • tub spout type: non diverter 	195827	78.35	Chrome	6
		195827BN	121.05	Brushed Nickel	6
		195827BG	121.05	Brushed Gold	6
		195827BL	133.20	Matte Black	6
	<ul style="list-style-type: none"> • connection: 1/2" slip fit • tub spout length: 5-1/2" • tub spout type: non diverter 	3959	71.05	Chrome	12
	<ul style="list-style-type: none"> • connection: 1/2" IPS • tub spout length: 7" • tub spout type: non diverter 	3828	62.90	Chrome	12
	<ul style="list-style-type: none"> • connection: 1/2" slip fit • tub spout length: 7" • tub spout type: non diverter 	3829	62.90	Chrome	12
		3829BN	144.25	Brushed Nickel	12
		3829BL	150.55	Matte Black	12
		3829ORB	158.70	Oil Rubbed Bronze	12

CUSTOM SHOWERING

One-Handle Wallmount Tub Spouts

CUSTOM SHOWERING

		MODEL	LIST	FINISH/CONNECT	CASE QTY
ONE-HANDLE WALLMOUNT TUB SPOUTS - PREMIUM					
	<ul style="list-style-type: none"> • matches Flara™ collection • tub spout length: 10" • tub spout type: non-diverting • spout manifold required: sold separately 	TFS990	365.00	Chrome	6
		TFS990BN	492.75	Brushed Nickel	6
		TFS990NL	492.75	Polished Nickel	6
		TFS990BG	492.75	Brushed Gold	6
	<ul style="list-style-type: none"> • matches Colinet™ collection • tub spout length: 10" • tub spout type: non-diverting • spout manifold required: sold separately 	TFS5001	376.05	Chrome	6
		TFS5001BN	507.65	Brushed Nickel	6
		TFS5001BG	507.65	Brushed Gold	6
		TFS5001BL	558.45	Matte Black	6
	<ul style="list-style-type: none"> • matches 90 Degree™ collection • tub spout length: 10" • tub spout type: non-diverting • spout manifold required: sold separately 	TFS3898	348.80	Chrome	6
		TFS3898BN	470.90	Brushed Nickel	6
		Q3 NEW! TFS3898BL	488.30	Matte Black	6
	<ul style="list-style-type: none"> • matches Doux™ collection • tub spout length: 10" • tub spout type: non-diverting • spout manifold required: sold separately 	TFS3836	348.80	Chrome	6
		TFS3836BN	488.30	Brushed Nickel	6
		TFS3836BL	537.15	Matte Black	6
ONE-HANDLE WALLMOUNT TUB SPOUTS					
NEW! Q3 	<ul style="list-style-type: none"> • matches Greenfield™ collection • tub spout length: 10" • tub spout type: non-diverting • spout manifold required: sold separately 	TF4326	360.15	Chrome	6
		TF4326BN	460.95	Brushed Nickel	6
		TF4326BG	460.95	Brushed Gold	6
		TF4326BL	507.10	Matte Black	6
	<ul style="list-style-type: none"> • matches Align® collection • tub spout length: 10" • tub spout type: non-diverting • spout manifold required: sold separately 	TF195827	360.15	Chrome	6
		TF195827BN	460.95	Brushed Nickel	6
		TF195827BG	460.95	Brushed Gold	6
		TF195827BL	507.10	Matte Black	6
	<ul style="list-style-type: none"> • matches Belfield® collection • tub spout length: 10" • tub spout type: non-diverting • spout manifold required: sold separately 	TF193371	300.00	Chrome	6
		TF193371BN	384.00	Brushed Nickel	6
		TF193371NL	384.00	Polished Nickel	6
		Q3 NEW! TF193371BL	403.15	Matte Black	6
		TF193371ORB	422.40	Oil Rubbed Bronze	6
	<ul style="list-style-type: none"> • modern style • tub spout length: 10" • tub spout type: non-diverting • spout manifold required: sold separately 	TF3347	322.50	Chrome	6
		TF3347BN	412.80	Brushed Nickel	6
		TF3347BG	412.80	Brushed Gold	6
		TF3347BL	454.10	Matte Black	6
	<ul style="list-style-type: none"> • matches Voss™ collection • tub spout length: 10" • tub spout type: non-diverting • spout manifold required: sold separately 	TF191956	335.00	Chrome	6
		TF191956BN	428.80	Brushed Nickel	6
		TF191956NL	428.80	Polished Nickel	6
		TF191956BG	428.80	Brushed Gold	6
		Q3 NEW! TF191956BL	450.15	Matte Black	6
		TF191956ORB	471.70	Oil Rubbed Bronze	6

HOW TO ORDER ONE HANDLE WALLMOUNT TUB SPOUTS







See Custom Showering Product Icon Key, page 363.

◆ BULK PACK AVAILABLE

◆◆ BULK PACK ONLY

One-Handle Wallmount Tub Spouts

		MODEL	LIST	FINISH/CONNECT	CASE QTY
ONE-HANDLE WALLMOUNT TUB SPOUTS					
 <ul style="list-style-type: none"> • matches Dartmoor® collection • tub spout length: 10" • tub spout type: non-diverting • spout manifold required: sold separately 		TF3858	225.00	Chrome	6
		TF3858BN	303.75	Brushed Nickel	6
		TF3858BL	334.15	Matte Black	6
		TF3858ORB	334.15	Oil Rubbed Bronze	6
 <ul style="list-style-type: none"> • matches Glyde™ collection • tub spout length: 10" • tub spout type: non-diverting • spout manifold required: sold separately 		TF195386	225.00	Chrome	6
		TF195386BN	303.75	Brushed Nickel	6
		TF195386BL	334.15	Matte Black	6
 <ul style="list-style-type: none"> • matches Genta™ LX collection • tub spout length: 10" • tub spout type: non-diverting • spout manifold required: sold separately 		TF3901	234.45	Chrome	6
		TF3901BN	316.50	Brushed Nickel	6
		TF3901BL	348.20	Matte Black	6
ONE-HANDLE WALLMOUNT TUB FILLER MANIFOLD					
 <ul style="list-style-type: none"> • spout manifold for wallmount tub filler • required for 10" tub filler spout installation 		MANCIS	58.55	N/A or Unfinished	12
		MANXS	58.55	N/A or Unfinished	12
		MANCXS	58.55	N/A or Unfinished	12

CUSTOM SHOWERING

HOW TO ORDER ONE HANDLE WALLMOUNT TUB SPOUTS











See Custom Showering Product Icon Key, page 363.

◆ BULK PACK AVAILABLE

◆◆ BULK PACK ONLY

Bath Tub and Shower Drains

		MODEL	LIST	FINISH/CONNECT	CASE QTY
TUB DRAINS					
	<ul style="list-style-type: none"> • top & bottom ells: schedule 40 abs • thread size: 1-1/2" 	140680	18.05	N/A or Unfinished	12
	<ul style="list-style-type: none"> • top & bottom ells: schedule 40 pvc • thread size: 1-1/2" 	140690	20.35	N/A or Unfinished	12
	<ul style="list-style-type: none"> • conversion bar kit • converts 2-hole top ell to accommodate 1-hole face plate 	142538	7.15	N/A or Unfinished	180
	<ul style="list-style-type: none"> • connection: 1-1/2" threaded shoe • tubing type: white pvc • fits tubs: 14 - 16" 	90530	67.10	Chrome	10
	<ul style="list-style-type: none"> • connection: 1-1/2" threaded shoe; male IPS 	T90331	45.65	Chrome	12
		T90331BN	143.95	Brushed Nickel	12
		T90331NL	143.95	Polished Nickel	12
		T90331BG	143.95	Brushed Gold	12
		T90331WR	158.35	Wrought Iron	12
		T90331ORB	158.35	Oil Rubbed Bronze	12
SHOWER DRAINS					
	<ul style="list-style-type: none"> • drain size: mounts on 2-5/8" centers 	101664BN	50.25	Brushed Nickel	12
		101664BG	50.25	Brushed Gold	12
		101664WR	55.40	Wrought Iron	12
		101664ORB	57.10	Oil Rubbed Bronze	12
	<ul style="list-style-type: none"> • drain size: mounts on 3-3/8" centers 	102763BN	50.25	Brushed Nickel	12
		102763BG	50.25	Brushed Gold	12
		102763WR	55.40	Wrought Iron	12
		102763ORB	57.10	Oil Rubbed Bronze	12
	<ul style="list-style-type: none"> • drain size: fits in 3" diameter drains 	101663BN	40.45	Brushed Nickel	12
		101663BG	40.45	Brushed Gold	12
		101663WR	44.55	Wrought Iron	12
		101663ORB	46.05	Oil Rubbed Bronze	12

Valves

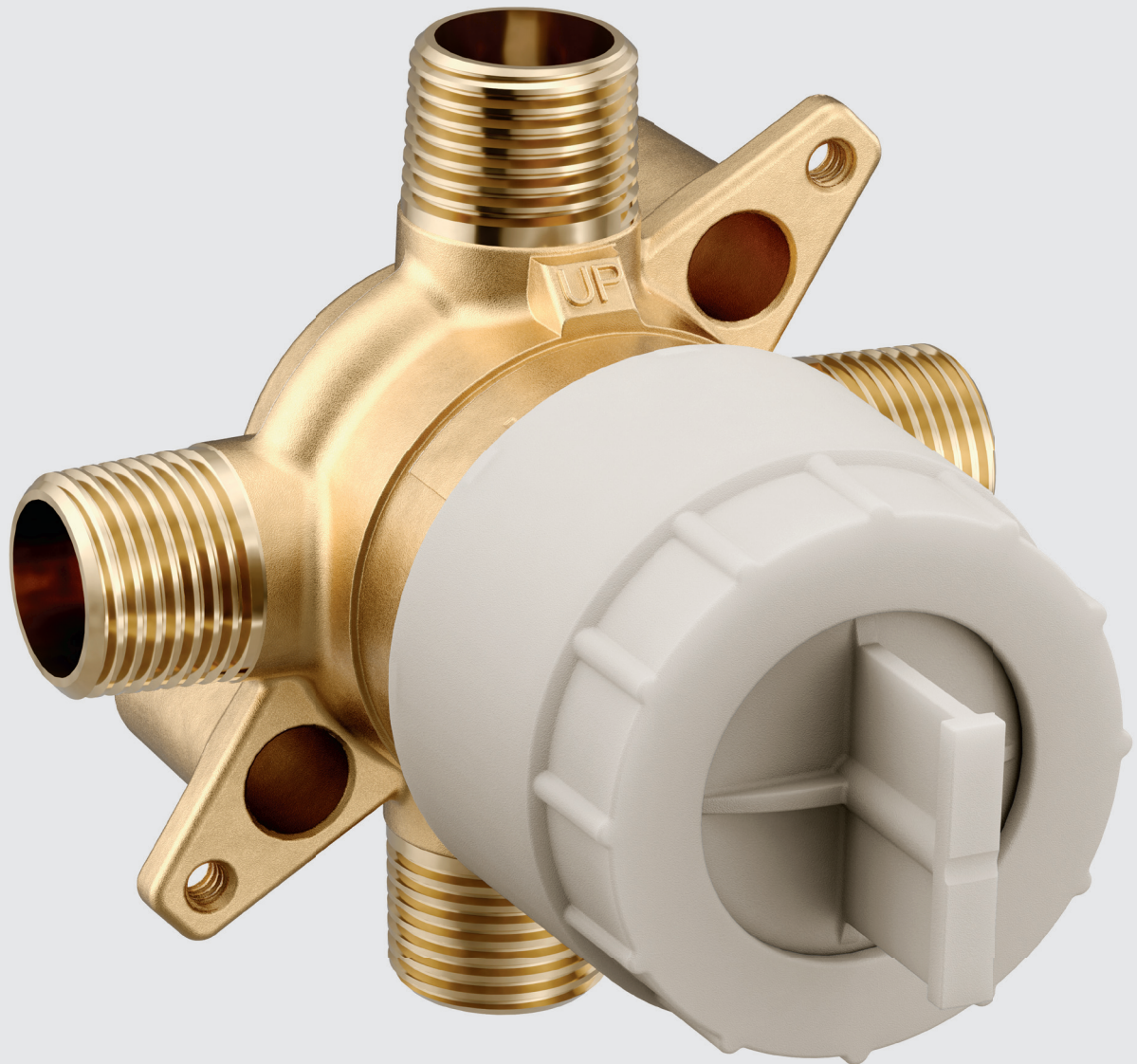

Whether you're designing a simple shower or an extravagant spa experience, Moen's valve portfolio allows you to create a space perfectly personalized to you. Designed with feedback from professional installers, our M-CORE universal valve system gives you the freedom to create the exact shower you want with nearly unlimited ways to combine preferred functionality with desired trim style - all while simplifying installation.

Bath Valves

COLLECTIONS

- 463 Widespread Valve
- 463 Wallmount Lavatory Valve
- 463 Freestanding Tub Filler Valves
- 463 Wallmount Tub Filler Valve
- 464 Roman Tub Valve
- 465 Smart Shower Thermostatic Valve
- 465 ExactTemp® Valve
- 465 M-CORE® Valve
- 467 Posi-Temp® Valve
- 471 Non-Pressure Balanced Valve
- 471 Flushmount Body Spray Valve
- 471 Bidet Valve

ICON KEY



Moen® M•PACT® Common Valve System

With M•PACT, you can change your faucet style without replacing any plumbing. It's as easy as changing a light bulb.

DURALOCK®

Push button connector makes installing faucets quick, secure, and hassle-free – no tools required. A telltale 'click' audibly signals connection.

DURALAST®

Provides the smooth feel and reliable operation of a new faucet from the first time you use it to the last.



Also available in bulk pack.
See page 589.



Available in bulk pack only.







VALVES

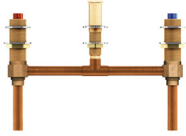

	MODEL	LIST	FINISH/CONNECT	CASE QTY
WIDESPREAD FAUCET VALVE				
 <ul style="list-style-type: none"> • application: three hole • center dimensions: 8" - 16" center • drain assembly: metal with lift rod 	9000◆	162.15	1/2" IPS	6
WALLMOUNT FAUCET VALVE				
 <ul style="list-style-type: none"> • application: three hole • center dimensions: 8" center • drain assembly: 140780 sold separately • includes: mounting brackets 	9700	229.35	1/2" CC	3
FREESTANDING TUB FILLER VALVE AND MOUNTING KIT - PREMIUM				
 <ul style="list-style-type: none"> • description: double riser floor joist mounting kit • application: two hole • center dimensions: 8" center • quarter turn stops: included 	TS50200	601.45	1/2" CC, NPT	2
 <ul style="list-style-type: none"> • description: double riser concrete mounting kit • application: two hole • center dimensions: 8" center • quarter turn stops: included 	TS50210	488.90	1/2" CC, NPT	2
FREESTANDING TUB FILLER VALVE AND MOUNTING KIT - PREMIUM				
 <ul style="list-style-type: none"> • description: single riser floor joist mounting kit • application: one hole • quarter turn stops: included 	TS50100	400.90	1/2" CC, NPT	2
 <ul style="list-style-type: none"> • description: single riser concrete mounting kit • application: one hole • quarter turn stops: included 	TS50110	325.95	1/2" CC, NPT	2
ONE-HANDLE WALLMOUNT TUB FILLER VALVE KIT				
 <ul style="list-style-type: none"> • application: two hole • center dimensions: adjustable • ports: three • quarter turn stops: included • includes: test plug • includes: spout manifold 	WMV130CIS	151.05	1/2" CC/IPS	6
	WMV130XS	151.05	1/2" Crimp Ring PEX	6
	WMV130CXS	151.05	1/2" Cold Expansion PEX	6

VALVES

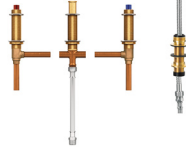





VALVES

	MODEL	LIST	FINISH/CONNECT	CASE QTY
TWO-HANDLE ROMAN TUB VALVE				
 <ul style="list-style-type: none"> • application: three hole • deck thickness: 1/8" to 3-3/8" rough-in deck • center dimensions: adjustable • adjustable spout shank: included • test plug: included <p>DURALAST®</p>	4792	188.55	1/2" CC	6
	4793	213.55	1/2" CPVC, Crimp Ring PEX	6
 <ul style="list-style-type: none"> • application: three hole • deck thickness: 1/8" to 2-3/4" rough-in deck • center dimensions: 10" - 24" center • adjustable spout shank: included • test plug: included <p>DURALOCK® DURALAST®</p>	4794	203.60	1/2" Crimp Ring PEX, Cold Expansion PEX	6
	4796	177.65	1/2" CC	6
 <ul style="list-style-type: none"> • application: three hole • deck thickness: 1/8" to 1-3/16" rough-in deck • center dimensions: 10" center • non-adjustable spout shank: included • test plug: included <p>DURALAST®</p>	4797	181.10	1/2" CPVC, Crimp Ring PEX	6
	4798	181.10	1/2" Crimp Ring PEX, Cold Expansion PEX	6

TWO-HANDLE ROMAN TUB VALVE WITH HANDSHOWER				
 <ul style="list-style-type: none"> • application: four hole • deck thickness: 1/8" to 2-5/8" rough-in deck • center dimensions: adjustable • non-adjustable spout shank: included • test plug: included <p>DURALAST®</p>	9792	424.85	1/2" CC	6
	9793	434.80	1/2" CPVC, Crimp Ring PEX	6
 <ul style="list-style-type: none"> • application: four hole • deck thickness: 1/8" to 2-5/8" rough-in deck • center dimensions: 10" - 24" center • adjustable spout shank: included • test plug: included <p>DURALOCK® DURALAST®</p>				

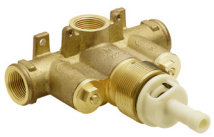
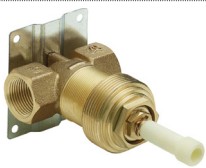

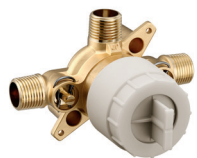

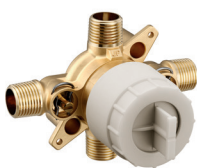







ROMAN TUB OPTIONS				
 <ul style="list-style-type: none"> • description: high flow thermostatic mixing valve for roman tubs • ports: three • ASSE standard 1070: yes • flow rate: 12.0 gpm (45.4 L/min) max 	104465	180.55	1/2" CC	12
	104466	180.55	1/2" IPS	12
	104464	180.55	1/2" Crimp Ring PEX	12
	104463	180.55	1/2" Cold Expansion PEX	12
 <ul style="list-style-type: none"> • description: PEX transition fittings (2) and clips • connections: adapts standard 1/2" PEX barb to 1/2" PEX cold expansion 	140715	12.70	PEX	200

VALVES





















		MODEL	LIST	FINISH/CONNECT	CASE QTY
SMART SHOWER 4 OUTLET THERMOSTATIC SHOWER VALVE - PREMIUM					
 <ul style="list-style-type: none"> description: digital thermostatic shower valve ports: four outlets features: precise temperature control connection: 3/4" CC inlets & 1/2" outlets installation: fits standard 2x4 wall includes: 30 foot data cable 		S3104	1800.30	3/4" CC	3
				BATTERY BACKUP SOLD SEPARATELY	
		179573	76.75	N/A or Unfinished	6
SMART SHOWER 2 OUTLET THERMOSTATIC SHOWER VALVE - PREMIUM					
 <ul style="list-style-type: none"> description: digital thermostatic shower valve ports: two outlets features: precise temperature control connection: 1/2" CC inlets & 1/2" outlets installation: fits standard 2x4 wall includes: 30 foot data cable 		S3102	842.45	1/2" CC	3
				BATTERY BACKUP SOLD SEPARATELY	
		179573	76.75	N/A or Unfinished	6
EXACTTEMP® THERMOSTATIC MIXING SHOWER VALVE - PREMIUM					
 <ul style="list-style-type: none"> description: thermostatic rough-in valve ports: four adjustable temp limit stop: included check stops: included 		S3371	714.65	3/4" IPS	6
EXACTTEMP® VOLUME CONTROL SHOWER VALVE - PREMIUM					
 <ul style="list-style-type: none"> description: volume control rough-in valve includes: volume control 		S3600	181.70	3/4" IPS	12
M-CORE® MIXING SHOWER VALVE					
 <ul style="list-style-type: none"> ports: three test plug: included cross flow plug: included 		U130CI	71.20	1/2" CC/IPS	6
		U130X	71.20	1/2" Crimp Ring PEX	6
		U130CX	71.20	1/2" Cold Expansion PEX	6
 <ul style="list-style-type: none"> ports: three adjustable temp limit stops: included quarter turn stops: included test plug: included 		U130CIS	102.45	1/2" CC/IPS	6
		U130XS	102.45	1/2" Crimp Ring PEX	6
		U130CXS	102.45	1/2" Cold Expansion PEX	6
 <ul style="list-style-type: none"> ports: four adjustable temp limit stop: included test plug: included cross flow plug: included 		U140CI	71.20	1/2" CC/IPS	6
		U140X	71.20	1/2" Crimp Ring PEX with CC/IPS Tub Outlet	6
		U140CX	71.20	1/2" Cold Exp PEX with CC/IPS Tub Outlet	6
		U140V	87.20	1/2" CPVC with CC/IPS Tub Outlet	6
 <ul style="list-style-type: none"> ports: four adjustable temp limit stop: included quarter turn stops: included test plug: included 		U140CIS	102.45	1/2" CC/IPS	6
		U140XS	102.45	1/2" Crimp Ring PEX with CC/IPS Tub Outlet	6
		U140CXS	102.45	1/2" Cold Exp PEX with CC/IPS Tub Outlet	6
		U140VS	118.50	1/2" CPVC with CC/IPS Tub Outlet	6



VALVES









		MODEL	LIST	FINISH/CONNECT	CASE QTY
M-CORE® PRE-FAB MIXING SHOWER VALVE					
	<ul style="list-style-type: none"> • ports: four • adjustable temp limit stop: included • test plug: included • cross flow plug: included 	U140X-PF	80.40	1/2" Crimp Ring PEX	3
		U140CX-PF	80.40	1/2" Cold Expansion PEX	3
	<ul style="list-style-type: none"> • ports: four • adjustable temp limit stop: included • quarter turn stops: included • test plug: included 	U140XS-PF	111.70	1/2" Crimp Ring PEX	3
		U140CXS-PF	111.70	1/2" Cold Expansion PEX	3
M-CORE® WITH INTEGRATED TRANSFER VALVE - 3 OR 6 FUNCTIONS					
	<ul style="list-style-type: none"> • ports: four, three outlets • adjustable temp limit stop: included • quarter turn stops: included • type of function: 2 independent/1 shared or 3 independent/3 shared • includes: volume control • test plug: included 	U362CIS	265.40	1/2" CC/IPS	6
		U362CXS	265.40	1/2" Cold Expansion PEX	6
		U362XS	265.40	1/2" Crimp Ring PEX	6
M-CORE® WITH INTEGRATED TRANSFER VALVE - 2 OR 3 FUNCTIONS					
	<ul style="list-style-type: none"> • ports: four, three outlets • adjustable temp limit stop: included • quarter turn stops: included • type of function: 2 independent or 3 independent • includes: volume control • test plug: included 	U232CIS	265.40	1/2" CC/IPS	6
		U232CXS	265.40	1/2" Cold Expansion PEX	6
		U232XS	265.40	1/2" Crimp Ring PEX	6
M-CORE® TRANSFER VALVE - 3 OR 6 FUNCTIONS					
	<ul style="list-style-type: none"> • description: transfer valve • ports: four, three outlets • type of function: 2 independent/1 shared or 3 independent/3 shared 	U361CI	149.70	1/2" CC/IPS	6
		U361CX	149.70	1/2" Cold Expansion PEX	6
		U361X	149.70	1/2" Crimp Ring PEX	6
M-CORE® TRANSFER VALVE - 2 OR 3 FUNCTIONS					
	<ul style="list-style-type: none"> • description: transfer valve • ports: four, three outlets • type of function: 2 independent or 3 independent 	U231CI	149.70	1/2" CC/IPS	6
		U231CX	149.70	1/2" Cold Expansion PEX	6
		U231X	149.70	1/2" Crimp Ring PEX	6

VALVES



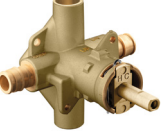



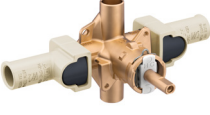



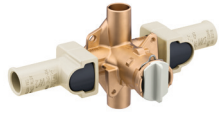

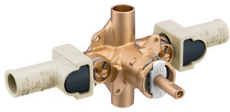

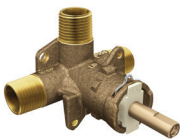

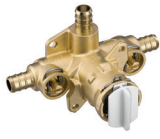

		MODEL	LIST	FINISH/CONNECT	CASE QTY
POSI-TEMP® MIXING SHOWER VALVE					
	<ul style="list-style-type: none"> • description: pressure balanced cycling valve • ports: four • adjustable temp limit stop: included 	2520	156.10	1/2" CC	6
	<ul style="list-style-type: none"> • description: pressure balanced cycling valve • ports: four • adjustable temp limit stop: included • bulk pack: yes 	62320◆	145.15	1/2" CC	12
	<ul style="list-style-type: none"> • description: pressure balanced cycling valve • ports: four • adjustable temp limit stop: included • test plug: included • bulk pack: yes 	FP62320◆	145.15	1/2" CC	12
	<ul style="list-style-type: none"> • description: pressure balanced cycling valve • ports: four • adjustable temp limit stop: included • quarter turn stops: included 	2570	189.55	1/2" CC	6
	<ul style="list-style-type: none"> • description: pressure balanced cycling valve • ports: four • adjustable temp limit stop: included • quarter turn stops: included • test plug: included • bulk pack: yes 	62370◆	176.45	1/2" CC	12
	<ul style="list-style-type: none"> • description: pressure balanced cycling valve • ports: four • adjustable temp limit stop: included • quarter turn stops: included • test plug: included • bulk pack: yes 	FP62370◆	176.45	1/2" CC	12
	<ul style="list-style-type: none"> • description: pressure balanced cycling valve • ports: four • adjustable temp limit stop: included 	2510	156.10	1/2" IPS	6
	<ul style="list-style-type: none"> • description: pressure balanced cycling valve • ports: four • adjustable temp limit stop: included • bulk pack: yes 	62300◆	145.15	1/2" IPS	12
	<ul style="list-style-type: none"> • description: pressure balanced cycling valve • ports: four • adjustable temp limit stop: included • test plug: included • bulk pack: yes 	FP62300◆	145.15	1/2" IPS	12
	<ul style="list-style-type: none"> • description: pressure balanced cycling valve • ports: four • adjustable temp limit stop: included • quarter turn stops: included 	2590	189.55	1/2" IPS	6

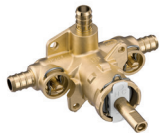
VALVES



















VALVES

		MODEL	LIST	FINISH/CONNECT	CASE QTY
POSI-TEMP® MIXING SHOWER VALVE					
	<ul style="list-style-type: none"> • description: pressure balanced cycling valve • ports: four • adjustable temp limit stop: included • quarter turn stops: included • bulk pack: yes 	62390◆	176.45	1/2" IPS	12
	<ul style="list-style-type: none"> • description: pressure balanced cycling valve • ports: four • adjustable temp limit stop: included 	2580	156.10	1/2" Crimp PEX	6
	<ul style="list-style-type: none"> • description: pressure balanced cycling valve • ports: four • adjustable temp limit stop: included • bulk pack: yes 	62380◆	145.15	1/2" Crimp Ring PEX	12
	<ul style="list-style-type: none"> • description: pressure balanced cycling valve • ports: four • adjustable temp limit stop: included • test plug: included • bulk pack: yes 	FP62380◆	145.15	1/2" Crimp Ring PEX	12
	<ul style="list-style-type: none"> • description: pressure balanced cycling valve • ports: four • adjustable temp limit stop: included • quarter turn stops: included • test plug: included • bulk pack: yes 	62360◆	176.45	1/2" Crimp Ring PEX	12
	<ul style="list-style-type: none"> • description: pressure balanced cycling valve • ports: four • adjustable temp limit stop: included • bulk pack: yes 	62365◆	145.15	1/2" Cold Expansion PEX	12
	<ul style="list-style-type: none"> • description: pressure balanced cycling valve • ports: four • adjustable temp limit stop: included • test plug: included • bulk pack: yes 	FP62365◆	145.15	1/2" Cold Expansion PEX	12
	<ul style="list-style-type: none"> • description: pressure balanced cycling valve • ports: four • adjustable temp limit stop: included • quarter turn stops: included • bulk pack: yes 	62385◆	176.45	1/2" Cold Expansion PEX	12
	<ul style="list-style-type: none"> • description: pressure balanced cycling valve • ports: four • adjustable temp limit stop: included • quarter turn stops: included • test plug: included • bulk pack: yes 	FP62385◆	176.45	1/2" Cold Expansion PEX	12
	<ul style="list-style-type: none"> • description: pressure balanced cycling valve • ports: four • adjustable temp limit stop: included • bulk pack: yes 	62340◆	161.05	1/2" CPVC	12















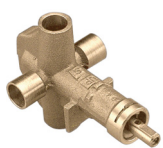

VALVES

		MODEL	LIST	FINISH/CONNECT	CASE QTY
POSI-TEMP® MIXING SHOWER VALVE					
	<ul style="list-style-type: none"> • description: pressure balanced cycling valve • ports: four • adjustable temp limit stop: included • test plug: included • bulk pack: yes 	FP62340◆	161.05	1/2" CPVC	12
	<ul style="list-style-type: none"> • description: pressure balanced cycling valve • ports: four • adjustable temp limit stop: included • quarter turn stops: included • bulk pack: yes 	62330◆	192.40	1/2" CPVC	12
	<ul style="list-style-type: none"> • description: pressure balanced cycling valve • ports: three • adjustable temp limit stop: included • bulk pack: yes 	62345◆	145.15	1/2" IPS, CC	12
POSI-TEMP® PRE-FAB MIXING SHOWER VALVES					
	<ul style="list-style-type: none"> • description: pressure balanced cycling valve • ports: three • adjustable temp limit stop: included • test plug: included • bulk pack: yes 	FP62325PF◆	158.15	1/2" Crimp Ring PEX	12
	<ul style="list-style-type: none"> • description: pressure balanced cycling valve • ports: three • adjustable temp limit stop: included • quarter turn stops: included • test plug: included • bulk pack: yes 	FP62326PF◆	189.45	1/2" Crimp Ring PEX	12
	<ul style="list-style-type: none"> • description: pressure balanced cycling valve • ports: three • adjustable temp limit stop: included • quarter turn stops: included 	2326PF	201.20	1/2" Crimp Ring PEX	6
	<ul style="list-style-type: none"> • description: pressure balanced cycling valve • ports: three • adjustable temp limit stop: included • test plug: included • bulk pack: yes 	FP62327PF◆	158.15	1/2" Cold Expansion PEX	12
	<ul style="list-style-type: none"> • description: pressure balanced cycling valve • ports: three • adjustable temp limit stop: included • connection: 1/2" cold expansion PEX • quarter turn stops: included • test plug: included 	FP62328PF◆	189.45	1/2" Cold Expansion PEX	12
	<ul style="list-style-type: none"> • description: pressure balanced cycling valve • ports: three • adjustable temp limit stop: included • quarter turn stops: included • bulk pack: yes 	2328PF	201.20	1/2" Cold Expansion PEX	6

VALVES

		MODEL	LIST	FINISH/CONNECT	CASE QTY
POSI-TEMP® PRE-FAB MIXING SHOWER VALVES					
	<ul style="list-style-type: none"> • description: pressure balanced cycling valve • ports: four • adjustable temp limit stop: included • test plug: included • bulk pack: yes 	FP62380PF◆	165.35	1/2" Crimp Ring PEX	12
	<ul style="list-style-type: none"> • description: pressure balanced cycling valve • ports: four • adjustable temp limit stop: included • test plug: included 	62380PF◆	165.35	1/2" Crimp Ring PEX	12
	<ul style="list-style-type: none"> • description: pressure balanced cycling valve • ports: four • adjustable temp limit stop: included • quarter turn stops: included • test plug: included • bulk pack: yes 	FP62360PF◆	196.55	1/2" Crimp Ring PEX	12
	<ul style="list-style-type: none"> • description: pressure balanced cycling valve • ports: four • adjustable temp limit stop: included • quarter turn stops: included • bulk pack: yes 	62360PF◆	196.55	1/2" Crimp Ring PEX	12
	<ul style="list-style-type: none"> • description: pressure balanced cycling valve • ports: four • adjustable temp limit stop: included • quarter turn stops: included 	2360PF	208.45	1/2" Crimp Ring PEX	3
	<ul style="list-style-type: none"> • description: pressure balanced cycling valve • ports: four • adjustable temp limit stop: included • test plug: included • bulk pack: yes 	FP62365PF◆	165.35	1/2" Cold Expansion PEX	12
	<ul style="list-style-type: none"> • description: pressure balanced cycling valve • ports: four • adjustable temp limit stop: included • bulk pack: yes 	62365PF◆	165.35	1/2" Cold Expansion PEX	12
	<ul style="list-style-type: none"> • description: pressure balanced cycling valve • ports: four • adjustable temp limit stop: included • quarter turn stops: included • test plug: included • bulk pack: yes 	FP62385PF◆	196.55	1/2" Cold Expansion PEX	12
	<ul style="list-style-type: none"> • description: pressure balanced cycling valve • ports: four • adjustable temp limit stop: included • quarter turn stops: included • test plug: included • bulk pack: yes 	62385PF◆	196.55	1/2" Cold Expansion PEX	12

VALVES

		MODEL	LIST	FINISH/CONNECT	CASE QTY
POSI-TEMP® WITH INTEGRATED TRANSFER VALVE - 3 FUNCTIONS					
	<ul style="list-style-type: none"> description: pressure balanced cycling valve with transfer valve ports: four adjustable temp limit stop: included type of function: two independent 1 shared 	2551	281.85	1/2" IPS	6
	<ul style="list-style-type: none"> description: pressure balanced cycling valve ports: four adjustable temp limit stop: included stops: included type of function: two independent 1 shared 	2581	317.40	1/2" IPS	6
POSI-TEMP® WITH INTEGRATED TRANSFER VALVE - 2 FUNCTIONS					
	<ul style="list-style-type: none"> description: pressure balanced cycling valve with transfer valve ports: four adjustable temp limit stop: included type of function: two discrete 	2521	281.85	1/2" IPS	6
	<ul style="list-style-type: none"> description: pressure balanced cycling valve with transfer valve ports: four adjustable temp limit stop: included type of function: two discrete stops: included 	2571	317.40	1/2" IPS	6
NON-PRESSURE BALANCED MIXING SHOWER VALVE					
	<ul style="list-style-type: none"> description: non-pressure balanced valve ports: four bulk pack: yes 	62700◆	132.20	1/2" IPS	12
	<ul style="list-style-type: none"> description: non-pressure balanced valve ports: four bulk pack: yes 	62720◆	132.20	1/2" CC	12
FLUSHMOUNT BODY SPRAY VALVE - PREMIUM					
	<ul style="list-style-type: none"> description: flushmount body spray valve installation: fits standard 2x4 wall 	S1300	124.00	1/2" IPS, CC	6
BIDET VALVE					
	<ul style="list-style-type: none"> application: three hole center dimensions: 8" - 16" center  DURALOCK® DURALAST®	9265	321.95	1/2" IPS	6

VALVES

VALVES M-CORE® Transfer Valve Plumbing Configurations

Plumb as recommended below for proper diverting functionality of showering devices.

VALVES

TWO INDEPENDENT FUNCTIONS

Function 1: Independent

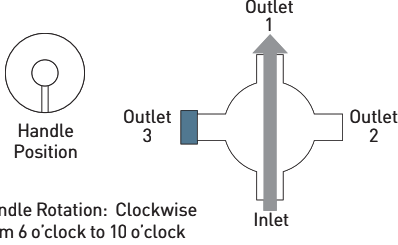

Function 2: Independent

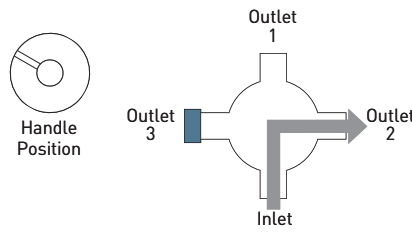

THREE INDEPENDENT FUNCTIONS

Function 1: Independent

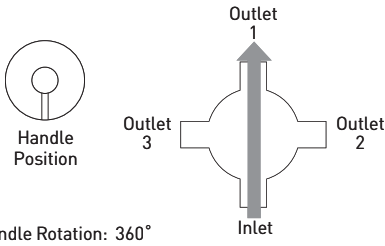

Handle Rotation: 360°

Function 2: Independent

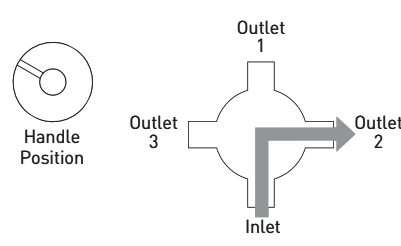

Function 3: Independent

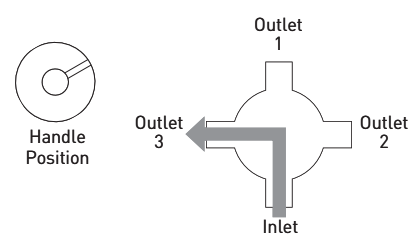

THREE FUNCTION - 2 INDEPENDENT AND 1 SHARED FUNCTION

Function 1: Independent

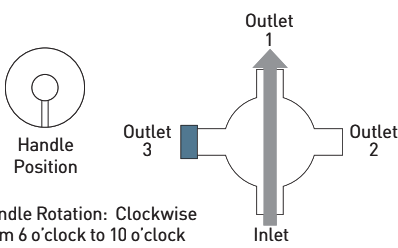

Function 2: Shared

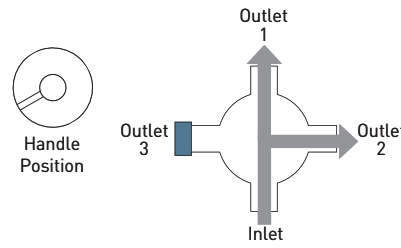

Function 3: Independent

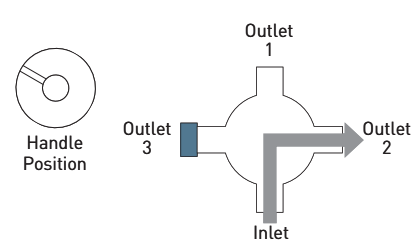

SIX FUNCTION - 3 INDEPENDENT AND 3 SHARED FUNCTIONS

Function 1: Independent

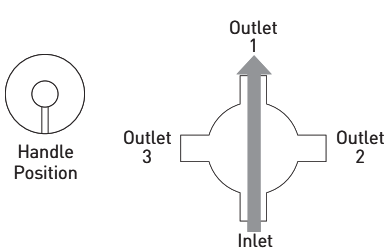

Function 2: Shared

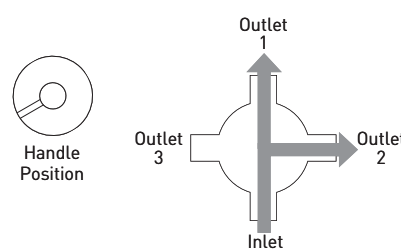

Function 3: Independent

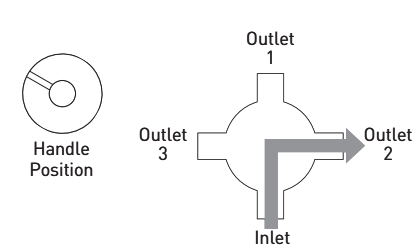

Function 4: Shared

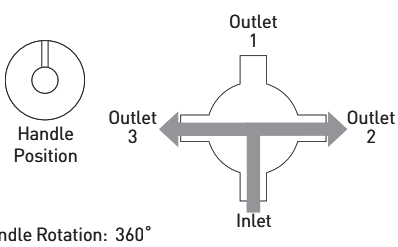

Handle Rotation: 360°

Function 5: Independent

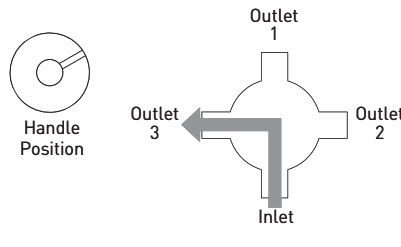

Function 6: Shared

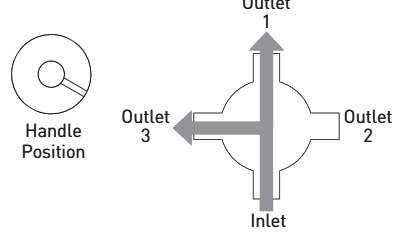

NOTES

- Outlet 1: to primary showering device
- Outlet 2: to second showering device
- Outlet 3: to third showering device

FLOW RATE VS. FLOWING INLET PRESSURE OF MOEN® SHOWERING VALVES (UNRESTRICTED)

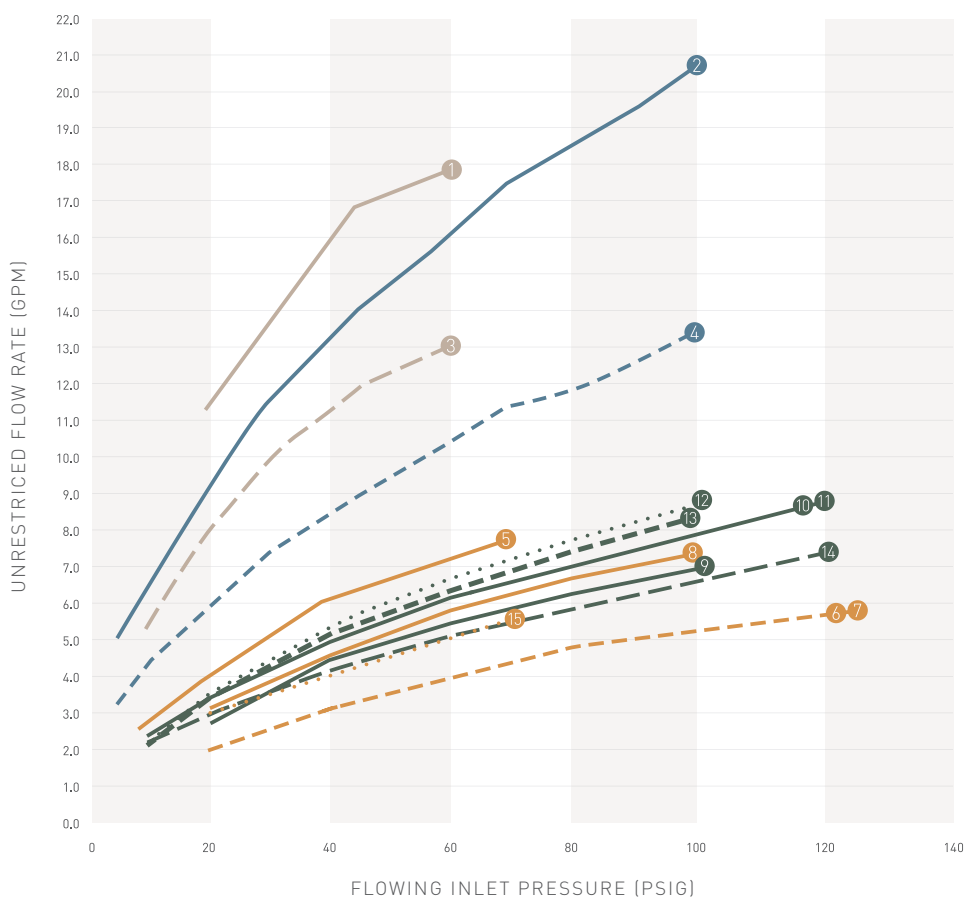

- 1 **ExactTemp[®] 3/4" Thermostatic Showering**
S3371 3/4" ExactTemp: 18.0 GPM
- 2 **Smart Shower—4-Outlet**
S3104 4-Outlet: 16.0 GPM
- 3 **Volume Control**
S3600 Volume Control: 13+ GPM
- 4 **Smart Shower—2-Outlet**
S3102 2-Outlet: 10.0 GPM
- 5 **Posi-Temp[®] Tub Port**
4-Port Valve
Flow at Tub: 6.3 GPM
- 6 **Posi-Temp Shower Port**
4-Port Valve
Flow at Shower: 4.0 GPM
- 7 **Posi-Temp Shower Port**
3-Port Valve
Flow at Tub: 6.3 GPM
- 8 **M-CORE[™] 4-Series Tub Port**
Flow at Tub: 5.7 GPM
- 9 **M-CORE 4-Series Shower Port**
Flow at Shower: 5.3 GPM
- 10 **M-CORE 3-Series Tub Port**
Flow at Tub: 6.2 GPM
- 11 **M-CORE 3-Series Shower Port**
Flow at Shower: 5.8 GPM
- 12 **M-CORE 2-Series Tub Port**
Flow at Tub: 6.7 GPM
- 13 **M-CORE 2-Series Shower Port**
Flow at Shower: 6.4 GPM
- 14 **M-CORE with Transfer**
Two Outlets: 5.6 GPM
- 15 **Posi-Temp with Integrated Transfer**
Two Outlets: 5.0 GPM

SHOWER SPA INSTALLATION RECOMMENDATIONS

Graph Line	Valves	Flow Rate through Shower Port (GPM) at 20 PSI	Flow Rate through Shower Port (GPM) at 40 PSI	Flow Rate through Shower Port (GPM) at 60 PSI	Use with a Transfer Valve	Maximum Components
1	ExactTemp [®] 3/4" Thermostatic S3371	11.4	15.7	18.0	No	4 Components: Any Combination of Showerheads, Handshowers and Body Sprays (4 max)
2	Smart Shower—4-Outlet S3104	9.0	13.0	16.0	No	4 Components: Any Combination of Showerheads, Handshowers and Body Sprays (4 max)
4	Smart Shower—2-Outlet S3102	6.0	8.5	10.0	No	Showerhead, Handshower or Showerhead, 2 Body Sprays
6	Posi-Temp 3-Port	3.6	5.1	6.3	Yes	Showerhead, Handshower or Showerhead, 2 Body Sprays*
7	M-CORE 4-Series Shower Port	2.9	4.3	5.3	Yes	Showerhead, Handshower or Showerhead, 2 Body Sprays*
9	M-CORE 3-Series Shower Port	3.1	4.6	5.8	Yes	Showerhead, Handshower or Showerhead, 2 Body Sprays*
11	M-CORE 2-Series Shower Port	3.5	5.1	6.4	Yes	Showerhead, Handshower or Showerhead, 2 Body Sprays*
13	M-CORE with Transfer	3.0	4.5	5.6	No	Showerhead, Handshower or Showerhead, 2 Body Sprays*
14	Posi-Temp Shower Port 4-Port	2.1	3.2	4.0	Yes	Showerhead, Handshower*
15	Posi-Temp with Integrated Transfer	3.0	4.0	5.0	No	Showerhead, Handshower

*Minimum 50 PSI recommended when plumbing a showerhead and 2 body sprays for shared flow.



COORDINATING ACCESSORIES





COORDINATING ACCESSORIES

Perfectly suited styles for a cohesive look. From robe hooks to towel bars, lighting to knobs and pulls, Moen® offers a wide range of coordinating accessories to complete any room.

90° Wallmount Tub Filler and Coordinating Accessories in Brushed Nickel

Coordinating Bath Accessories

COLLECTIONS

- 478 Accessory Collections
- 480 Pro-Fit® Installation System
- 481 Kitchen Compliments
- 482 Mason®
- 483 Retreat®
- 484 Arlys™
- 485 Triva™
- 486 Sage®
- 487 Iso™
- 488 Kyvos®
- 489 Lounge™
- 490 Madison™
- 491 Preston™
- 492 Aspen™
- 493 Kingsley®
- 494 Gilcrest®
- 494 Glenshire®
- 495 Donner™
- 502 30" Towel Bars
- 503 Shower Rods and Rings
- 509 Moen® Lighting
- 514 Moen Knobs & Pulls
- 518 Grab Bar Guide
- 519 SecureMount™ System
- 520 Grab Bars
- 532 Bath Safety

FINISHES

- Chrome
- Brushed Nickel
- Brushed Gold
- Polished Nickel
- Oil Rubbed Bronze
- Matte Black
- Wrought Iron/Matte Black
- Brushed Chrome
- Wrought Iron/Matte Black**
Wrought Iron and Matte Black are the same finish and interchangeable.





Accessory Collections

All of our bath accessory collections feature a towel ring, robe hook, 18" and 24" towel bars, and a paper holder. And there is so much more — hotel shelves, tank levers, mirrors and glass shelves are offered in many collections.



Pivoting Paper Holders

Now there's no excuse to leave the bath tissue roll empty! Many Moen® paper holders feature an innovative, spring-free design that makes changing the roll quick and easy. Simply lift the arm, insert the new roll and set the arm back into place. The pivoting arm remains attached so there's no spring to lose and no extra parts to drop.



Knobs and Pulls

With our distinctive collection of knobs and pulls, you can create a perfectly matched kitchen or bath, available in an array of styles and finishes.

Shower Rods

Add an elegant and luxurious look while also creating a more comfortable experience in the bath with a choice of shower rods and rings. Moen rods and rings are available in several of today's most popular finishes. These rods are featured in straight and curved styles giving you the room you need in the shower.





Grab Bars

Stylish grab bars like Arris™ bring safety and style to the bath in your choice of Chrome, Brushed Nickel, Oil Rubbed Bronze, Matte Black, and Brushed Gold finishes. Even better, SecureMount™ Anchors make installation possible anywhere on the wall, with or without studs.



Decorative Hotel Shelves

Eva®, Iso™ and Arlys™ decorative hotel shelves help create the high-end, coordinated styling of an upscale hotel while adding valuable storage space.



Bathroom Lighting

Lighting fixtures are available in several of our most popular Moen® bathroom collections. All of the styles can be mounted with globes facing either up or down.

In addition to high-end style, our lighting provides installation benefits. The Quick-Connect Wiring System lets you pre-wire the light fixture to the junction box, meaning there is no need to hold the fixture up to the wall during the wiring process. Glazed sockets help ensure the socket rings install with ease. Additionally, the UL®-listed fixtures are backed by the Moen warranty and our industry-leading customer service.

Pro-Fit® Installation System

The Moen® three-step Pro-Fit® Installation System is the simple, most innovative way to mount bath accessories. Installation is as easy as 1-2-3.



DRILL IT

The innovative template has a built-in level for accurate drilling of pilot holes for both 18" and 24" towel bars or paper holders.



SCREW IT

The single-screw mounting system creates a fast and solid installation.



CLICK IT

The locking tab clicks to hold the post firmly in place and eliminates the need for a set screw.

IT REALLY IS THAT SIMPLE!

Plus, we've eliminated the set screw. Designed with input from professional installers, the Pro-Fit Installation System was made for faster installation and fewer callbacks. And of course, there's the extra assurance of quality that comes with the Moen brand.

Visit moenpro.com to view online installation videos.

Pro-Fit Installation Template:
YB8081

The Pro-Fit Installation System eliminates set screws for faster, easier mounting. There's even a template with a built-in level.



Moen® Kitchen Complements

EXCEPTIONAL FAUCETS ARE ONLY THE BEGINNING

Who says Moen® towel bars are just for the bathroom? With several faucet-matching collections featuring both kitchen and bath fixture options — such as Weymouth®, Align™, Belfield™ and more — we've made sure our accessories can also do double-duty in the kitchen.

Position a towel bar or towel ring beside the kitchen sink or on a kitchen island. Place a hook to hang potholders. Install a decorative shelf to house spices. And don't forget matching drawer knobs and pulls that help you carry the style throughout the workspace.

Kitchen complements is about creating a kitchen without compromise. Moen offers exceptional products that deliver all the style and functionality you need in a dream kitchen — with the convenience of getting it all from one trusted brand. That means a guaranteed style compatibility, quality and satisfaction.



MASON® Coordinating Bath Accessories

Moen® bath accessories CANNOT be combined with Moen faucet parts on a Purchase Order.

COORDINATING ACCESSORIES

Perfectly suited styles for a cohesive look. From robe hooks to towel bars, Moen offers a wide range of coordinating accessories to complete any room.

COORDINATING ACCESSORIES

MODEL NUMBER	LIST EACH	DESCRIPTION	QTY
Chrome (CH)			
YB8000CH	6.00	Mounting Posts (Pair)	50
YB8003CH	5.25	Double Robe Hook	50
YB8086CH	9.90	Towel Ring	50
YB8088CH	10.85	Double Paper Holder (Roller not included)	25
YB8094CH	5.00	24" Towel Bar (Bar Only)	50
YB8098CH	4.30	18" Towel Bar (Bar Only)	50
YB8099CH	2.10	Paper Holder (Roller Only)	50
Brushed Chrome (BC)			
YB8000BC	7.65	Mounting Posts (Pair)	50
YB8003BC	6.70	Double Robe Hook	50
YB8086BC	13.05	Towel Ring	50
YB8094BC	6.45	24" Towel Bar (Bar Only)	50
YB8098BC	5.45	18" Towel Bar (Bar Only)	50
YB8099BC	3.55	Paper Holder (Roller Only)	50
Satin Nickel (SN)			
YB8000SN	9.90	Mounting Posts (Pair)	50
YB8003SN	6.85	Double Robe Hook	50
YB8086SN	14.15	Towel Ring	50
YB8088SN	17.70	Double Paper Holder (Roller not included)	25
YB8094SN	8.20	24" Towel Bar (Bar Only)	50
YB8098SN	6.60	18" Towel Bar (Bar Only)	50
YB8099SN	3.20	Paper Holder (Roller Only)	50
YB80000WB	12.85	Mounting Posts (Pair)	50
Old World Bronze (OWB)			
YB80000WB	12.85	Mounting Posts (Pair)	50
YB80030WB	7.85	Double Robe Hook	50
YB80860WB	15.15	Towel Ring	50
YB80940WB	10.15	24" Towel Bar (Bar Only)	50
YB80980WB	7.65	18" Towel Bar (Bar Only)	50
YB80990WB	2.70	Paper Holder (Roller Only)	50
N/A or Unfinished			
YB8081	14.90		25



Double Robe Hook
YB8003



Towel Ring
YB8086



Paper Holder (Roller only)
YB8099



Double Paper Holder (3 Mounting Posts, rollers not included) (Available in CH and SN only)
YB8088

+
Mounting Posts (Pair)
YB8000



18" Towel Bar (bar only)
YB8098

24" Towel Bar (bar only)
YB8094

+
Mounting Posts (Pair)
YB8000



YB8081
Pro-Fit® Installation Mounting Template
(See page 480 for more information about the Pro-Fit® Installation System.)

List price is per each (unless otherwise noted).
Product can be ordered by case quantity or individually.
For more information on ordering Mason bath accessories or other Moen bath accessories, contact Moen Bath Accessory Customer Service at **800-882-0116**, contact your local Moen sales representative, or visit us at www.moen.com.

RETREAT® Coordinating Bath Accessories

Moen® bath accessories CANNOT be combined with Moen faucet parts on a Purchase Order.

COORDINATING ACCESSORIES

Perfectly suited styles for a cohesive look. From robe hooks to towel bars, Moen offers a wide range of coordinating accessories to complete any room.

MODEL NUMBER	LIST EACH	DESCRIPTION	QTY
Chrome (CH)			
DN8303CH	17.70	Single Robe Hook	24
Ⓟ DN8308CH	33.95	Pivoting Paper Holder	3
DN8318CH	34.70	18" Towel Bar	3
DN8322CH	57.35	24" Double Towel Bar	3
DN8324CH	37.65	24" Towel Bar	3
DN8386CH	24.50	Towel Ring	3
DN8390CH	64.05	Vanity Shelf	3
Brushed Nickel (BN)			
DN8303BN▲	19.85	Single Robe Hook	24
Ⓟ DN8308BN▲	37.85	Pivoting Paper Holder	3
DN8318BN▲	38.80	18" Towel Bar	3
DN8322BN▲	64.05	24" Double Towel Bar	3
DN8324BN▲	42.10	24" Towel Bar	3
DN8386BN▲	27.40	Towel Ring	3
DN8390BN▲	71.40	Vanity Shelf	3

Product Details

5/8" Round Bar

30" Towel Bar options also available in select finishes.

See page 502 for details.



Single Robe Hook
DN8303



Towel Ring
DN8386



Pivoting Paper Holder
DN8308 | Ⓟ



18" Towel Bar
DN8318

24" Towel Bar
DN8324



24" Double Towel Bar
DN8322



Vanity Shelf
DN8390

COORDINATING ACCESSORIES

▲ Retail Packaging

Ⓟ Denotes pivoting paper holder and mirror

List price is per eachch (unless otherwise noted).

Product can be ordered by case quantity or individually.

For more information on ordering Retreat bath accessories or other Moen bath accessories, contact Moen Bath Accessory Customer Service at **800-882-0116**, contact your local Moen sales representative, or visit us at www.moen.com.

ARLYS™ Coordinating Bath Accessories

Moen® bath accessories CANNOT be combined with Moen faucet parts on a Purchase Order.

COORDINATING ACCESSORIES

Perfectly suited styles for a cohesive look. From robe hooks to towel bars, Moen offers a wide range of coordinating accessories to complete any room.

MODEL NUMBER	LIST EACH	DESCRIPTION	QTY
Chrome (CH)			
Y5703CH▲	19.75	Double Robe Hook	12
Y5708CH▲	24.60	Paper Holder	3
Y5709CH▲	33.05	Single-Post Paper Holder	3
Y5718CH▲	43.25	18" Towel Bar	3
Y5722CH▲	73.50	24" Double Towel Bar	3
Y5724CH▲	47.00	24" Towel Bar	3
Y5785CH▲	33.35	Towel Ring	3
Y5786CH▲	23.05	Hand Towel Bar	3
Y5788CH▲	42.45	Double Paper Holder	3
Y5794CH▲	193.10	Towel Shelf	2
Brushed Nickel (BN)			
Y5703BN▲	23.70	Double Robe Hook	12
Y5708BN▲	28.90	Paper Holder	3
Y5709BN▲	37.45	Single-Post Paper Holder	3
Y5718BN▲	49.45	18" Towel Bar	3
Y5722BN▲	81.55	24" Double Towel Bar	3
Y5724BN▲	54.40	24" Towel Bar	3
Y5785BN▲	37.55	Towel Ring	3
Y5786BN▲	27.00	Hand Towel Bar	3
Y5788BN▲	50.95	Double Paper Holder	3
Y5794BN▲	193.30	Towel Shelf	2
Matte Black (BL)			
Y5703BL▲	28.50	Double Robe Hook	12
Y5708BL▲	34.65	Paper Holder	3
Y5709BL▲	43.35	Single-Post Paper Holder	3
Y5718BL▲	62.30	18" Towel Bar	3
Y5722BL▲	105.90	24" Double Towel Bar	3
Y5724BL▲	67.60	24" Towel Bar	3
Y5785BL▲	42.25	Towel Ring	3
Y5786BL▲	31.50	Hand Towel Bar	3
Y5788BL▲	61.15	Double Paper Holder	3
Y5794BL▲	219.05	Towel Shelf	2

**Double Robe Hook**

Y5703

**Towel Ring**

Y5785

**Paper Holder**

Y5708

**Single-Post Paper**

Y5709

**Double Paper Holder**

Y5788

**Hand Towel Bar**

Y5786

**18" Towel Bar**

Y5718

**24" Double Towel Bar**

Y5722

24" Towel Bar

Y5724

**Towel Shelf**

Y5794

COORDINATING
ACCESSORIES

▲ **Retail Packaging**

List price is per each (unless otherwise noted).

Product can be ordered by case quantity or individually.

For more information on ordering Arlys bath accessories or other Moen bath accessories, contact Moen Bath Accessory Customer Service at **800-882-0116**, contact your local Moen sales representative, or visit us at www.moen.com.

TRIVA™ Coordinating Bath Accessories

Moen® bath accessories CANNOT be combined with Moen faucet parts on a Purchase Order.

COORDINATING ACCESSORIES

Perfectly suited styles for a cohesive look. From robe hooks to towel bars, Moen offers a wide range of coordinating accessories to complete any room.

MODEL NUMBER	LIST EACH	DESCRIPTION	QTY
Chrome (CH)			
BP1803CH	19.75	Single Robe Hook	24
BP1808CH	33.05	Single-Post Paper Holder	6
BP1818CH	43.25	18" Towel Bar	6
BP1822CH	73.50	24" Double Towel Bar	6
BP1824CH	47.00	24" Towel Bar	6
BP1886CH	24.75	Hand Towel Bar	6
BP1888CH	42.45	Single-Post Double Paper Holder	6
BP1892CH	247.10	Mirror	1
Brushed Nickel (BN)			
BP1803BN	23.70	Single Robe Hook	24
BP1808BN	37.45	Single-Post Paper Holder	6
BP1818BN	49.45	18" Towel Bar	6
BP1822BN	81.55	24" Double Towel Bar	6
BP1824BN	54.40	24" Towel Bar	6
BP1886BN	29.65	Hand Towel Bar	6
BP1888BN	50.95	Single-Post Double Paper Holder	6
BP1892BN	296.50	Mirror	1
Matte Black (BL)			
BP1803BL	28.50	Single Robe Hook	24
BP1808BL	43.35	Single-Post Paper Holder	6
BP1818BL	62.30	18" Towel Bar	6
BP1822BL	105.90	24" Double Towel Bar	6
BP1824BL	67.60	24" Towel Bar	6
BP1886BL	34.60	Hand Towel Bar	6
BP1888BL	61.15	Single-Post Double Paper Holder	6
BP1892BL	355.85	Mirror	1

**Single Robe Hook**

BP1803

**Hand Towel Bar**

BP1886

**Paper Holder-Single Post**

BP1808

**Double Paper Holder-Single Post**

BP1888

**18" Towel Bar**

BP1818

24" Towel bar

BP1824

**24" Double Towel Bar**

BP1822

**Rectangular Mirror**

BP1892

COORDINATING
ACCESSORIES

List price is per eachch (unless otherwise noted).

Product can be ordered by case quantity or individually.

For more information on ordering Triva bath accessories or other Moen bath accessories, contact Moen Bath Accessory Customer Service at **800-882-0116**, contact your local Moen sales representative, or visit us at www.moen.com.

SAGE® Coordinating Bath Accessories

Moen® bath accessories CANNOT be combined with Moen faucet parts on a Purchase Order.

COORDINATING ACCESSORIES

Perfectly suited styles for a cohesive look. From robe hooks to towel bars, Moen offers a wide range of coordinating accessories to complete any room.

COORDINATING ACCESSORIES

MODEL NUMBER	LIST EACH	DESCRIPTION	QTY
Chrome (CH)			
DN6801CH	21.85	Tank Lever	3
DN6803CH	13.60	Single Robe Hook	3
Ⓟ DN6808CH	25.95	Pivoting Paper Holder	3
DN6818CH	30.35	18" Towel Bar	3
DN6824CH	32.95	24" Towel Bar	3
DN6886CH	21.45	Towel Ring	3
Brushed Nickel (BN)			
DN6801BN	33.20	Tank Lever	12
DN6803BN	22.25	Single Robe Hook	12
Ⓟ DN6808BN	34.60	Pivoting Paper Holder	3
DN6818BN	40.90	18" Towel Bar	3
DN6822BN	67.50	24" Double Towel Bar	3
DN6824BN	44.40	24" Towel Bar	3
DN6850BN	66.00	Freestanding Paper Holder	2
DN6886BN	31.00	Towel Ring	3
DN6890BN	65.60	Vanity Shelf	3
Ⓟ DN6892BN	127.35	Pivoting Mirror	3
Oil Rubbed Bronze (ORB)			
DN6801ORB	36.60	Tank Lever	12
DN6803ORB	22.50	Single Robe Hook	12
Ⓟ DN6808ORB	38.25	Pivoting Paper Holder	3
DN6818ORB	42.50	18" Towel Bar	3
DN6824ORB	46.20	24" Towel Bar	3
DN6886ORB	31.35	Towel Ring	3

Product Details

5/8" Round Bar

30" Towel Bar options also available in select finishes.

See page 502 for details.



Tank Lever
DN6801



Single Robe Hook
DN6803



Towel Ring
DN6886



Paper Holder
DN6808 | Ⓟ



Freestanding Paper Holder (BN Only)
DN6850



18" Towel Bar
DN6818

24" Towel Bar
DN6824



24" Double Towel Bar (BN Only)
DN6822

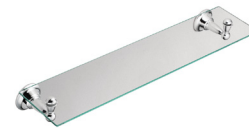

Vanity Shelf (BN Only)
DN6890



Pivoting Mirror (BN Only)
DN6892 | Ⓟ

Ⓟ Denotes pivoting paper holder and mirror

List price is per each (unless otherwise noted).

Product can be ordered by case quantity or individually.

For more information on ordering Sage bath accessories or other Moen bath accessories, contact Moen Bath Accessory Customer Service at 800-882-0116, contact your local Moen sales representative, or visit us at www.moen.com.

Moen® bath accessories CANNOT be combined with Moen faucet parts on a Purchase Order.

COORDINATING ACCESSORIES

Perfectly suited styles for a cohesive look. From robe hooks to towel bars, Moen offers a wide range of coordinating accessories to complete any room.

MODEL NUMBER	LIST EACH	DESCRIPTION	QTY
Chrome (CH)			
DN0703CH	25.40	Single Robe Hook	12
DN0705CH	10.95	Drawer Knob	48
DN0707CH	21.85	Drawer Pull	48
Ⓟ DN0708CH	50.00	Pivoting Paper Holder	3
DN0709CH	45.95	Single-Post Paper Holder	3
DN0718CH	46.00	18" Towel Bar	3
DN0722CH	75.00	24" Double Towel Bar	3
DN0724CH	50.00	24" Towel Bar	3
DN0786CH	32.45	Towel Ring	3
DN0790CH	90.65	Vanity Shelf	3
Ⓟ DN0792CH	121.30	Pivoting Mirror	3
DN0794CH	212.20	Towel Shelf	2
Brushed Nickel (BN)			
DN0703BN	28.55	Single Robe Hook	24
DN0705BN	12.80	Drawer Knob	48
DN0707BN	23.55	Drawer Pull	48
Ⓟ DN0708BN	56.30	Pivoting Paper Holder	3
DN0709BN	51.40	Single-Post Paper Holder	3
DN0718BN	53.25	18" Towel Bar	3
DN0722BN	84.15	24" Double Towel Bar	3
DN0724BN	58.00	24" Towel Bar	3
DN0786BN	39.40	Towel Ring	3
DN0790BN	102.05	Vanity Shelf	3
Ⓟ DN0792BN	136.50	Pivoting Mirror	3
DN0794BN	229.45	Towel Shelf	2
Brushed Gold (BG)			
DN0705BG	15.35	Drawer Knob	48
DN0707BG	28.20	Drawer Pull	48
Matte Black (BL)			
DN0703BL▲	31.45	Single Robe Hook	12
DN0705BL	13.30	Drawer Knob	48
DN0707BL	26.40	Drawer Pull	48
Ⓟ DN0708BL▲	61.95	Pivoting Paper Holder	3
DN0709BL▲	56.55	Single-Post Paper Holder	3
DN0718BL▲	58.55	18" Towel Bar	3
DN0722BL▲	92.60	24" Double Towel Bar	3
DN0724BL▲	63.80	24" Towel Bar	3
DN0786BL▲	43.40	Towel Ring	3
DN0790BL▲	112.25	Vanity Shelf	3
Ⓟ DN0792BL▲	150.15	Pivoting Mirror	3
DN0794BL▲	252.40	Towel Shelf	2

Product Details

1/2" Round Bar

▲ Retail Packaging

Ⓟ Denotes pivoting paper holder and mirror

List price is per each (unless otherwise noted).

Product can be ordered by case quantity or individually.

For more information on ordering ISO bath accessories or other Moen bath accessories, contact Moen Bath Accessory Customer Service at **800-882-0116**, contact your local Moen sales representative, or visit us at **www.moen.com**.



Single Robe Hook

DN0703



Towel Ring

DN0786



Pivoting Paper Holder

DN0708 | Ⓟ



Single-Post Paper Holder

DN0709



18" Towel Bar

DN0718



24" Double Towel Bar

DN0722

24" Towel Bar

DN0724



Drawer Knob

DN0705



Drawer Pull

DN0707



Towel Shelf

DN0794



Vanity Shelf

DN0790



Pivoting Mirror

DN0792 | Ⓟ

COORDINATING ACCESSORIES

KYVOS® Coordinating Bath Accessories

Moen® bath accessories CANNOT be combined with Moen faucet parts on a Purchase Order.

COORDINATING ACCESSORIES

Perfectly suited styles for a cohesive look. From robe hooks to towel bars, Moen offers a wide range of coordinating accessories to complete any room.

MODEL NUMBER	LIST EACH	DESCRIPTION	QTY
Chrome (CH)			
BP3703CH▲	29.85	Double Robe Hook	24
BP3708CH▲	43.35	Paper Holder	6
BP3718CH▲	56.85	18" Towel Bar	6
BP3724CH▲	59.45	24" Towel Bar	6
BP3786CH▲	46.05	Towel Ring	6
Brushed Nickel (BN)			
BP3703BN	33.65	Double Robe Hook	24
BP3708BN	48.75	Paper Holder	6
BP3718BN	63.90	18" Towel Bar	6
BP3724BN	69.55	24" Towel Bar	6
BP3786BN	51.75	Towel Ring	6



Double Robe Hook
BP3703



Towel Ring
BP3786



Paper Holder
BP3708



18" Towel Bar
BP3718
24" Towel Bar
BP3724

COORDINATING ACCESSORIES

▲ Retail Packaging

List price is per each (unless otherwise noted).

Product can be ordered by case quantity or individually.

For more information on ordering Kyvos bath accessories or other Moen bath accessories, contact Moen Bath Accessory Customer Service at **800-882-0116**, contact your local Moen sales representative, or visit us at www.moen.com.

LOUNGE™ Coordinating Bath Accessories

Moen® bath accessories CANNOT be combined with Moen faucet parts on a Purchase Order.

COORDINATING ACCESSORIES

Perfectly suited styles for a cohesive look. From robe hooks to towel bars, Moen offers a wide range of coordinating accessories to complete any room.

MODEL NUMBER	LIST EACH	DESCRIPTION	QTY
Chrome (CH)			
DN7703CH▲	15.55	Double Robe Hook	24
DN7708CH▲	28.85	European Paper Holder	3
DN7718CH▲	30.40	18" Towel Bar	3
DN7722CH▲	47.95	24" Double Towel Bar	3
DN7724CH▲	33.00	24" Towel Bar	3
DN7786CH▲	21.60	Towel Ring	3
DN7790CH▲	52.00	Vanity Shelf	3
Brushed Nickel (BN)			
DN7703BN▲	18.05	Double Robe Hook	24
DN7708BN▲	33.10	European Paper Holder	3
DN7718BN▲	34.95	18" Towel Bar	3
DN7722BN▲	55.10	24" Double Towel Bar	3
DN7724BN▲	38.00	24" Towel Bar	3
DN7786BN▲	24.80	Towel Ring	3
DN7790BN▲	59.85	Vanity Shelf	3

Product Details

5/8" Round Bar

30" Towel Bar options also available in select finishes.

See page 502 for details.

**Double Robe Hook**

DN7703

**Towel Ring**

DN7786

**European Paper Holder**

DN7708

**18" Towel Bar**

DN7718

24" Towel Bar

DN7724

**Double Towel Bar**

DN7722

**Vanity Shelf**

DN7790

**COORDINATING
ACCESSORIES**

▲ **Retail Packaging**

List price is per each (unless otherwise noted).

Product can be ordered by case quantity or individually.

For more information on ordering Lounge bath accessories or other Moen bath accessories, contact Moen Bath Accessory Customer Service at **800-882-0116**, contact your local Moen sales representative, or visit us at **www.moen.com**.

MADISON® Coordinating Bath Accessories

Moen® bath accessories CANNOT be combined with Moen faucet parts on a Purchase Order.

COORDINATING ACCESSORIES

Perfectly suited styles for a cohesive look. From robe hooks to towel bars, Moen offers a wide range of coordinating accessories to complete any room.

MODEL NUMBER	LIST EACH	DESCRIPTION	QTY
Chrome (CH)			
BP6903CH▲	12.30	Double Robe Hook	24
BP6908CH▲	27.15	Paper Holder	6
BP6918CH▲	28.40	18" Towel Bar	6
BP6924CH▲	31.30	24" Towel Bar	6
BP6980CH▲	22.80	European Paper Holder	6
BP6986CH▲	20.45	Towel Ring	6
Old World Bronze (OWB)			
BP6903OWB	18.65	Double Robe Hook	24
BP6908OWB	36.60	Paper Holder	6
BP6918OWB	35.50	18" Towel Bar	6
BP6924OWB	41.35	24" Towel Bar	6
BP6980OWB	27.60	European Paper Holder	6
BP6986OWB	25.60	Towel Ring	6
Pewter (PW)			
DN6903PW▲	18.50	Double Robe Hook	24
BP6908PW▲	36.65	Paper Holder	6
DN6918PW▲	34.50	18" Towel Bar	3
BP6924PW▲	41.35	24" Towel Bar	6
BP6986PW▲	25.55	Towel Ring	6

Product Details

3/4" Round Bar

**Double Robe Hook**

BP6903

DN6903

**Towel Ring**

BP6986

**Paper Holder**

BP6908

**European Paper Holder**

BP6980

**18" Towel Bar**

BP6918

DN6918

24" Towel Bar

BP6924

COORDINATING
ACCESSORIES

▲ Retail Packaging

List price is per each (unless otherwise noted).

Product can be ordered by case quantity or individually.

For more information on ordering Madison bath accessories or other Moen bath accessories, contact Moen Bath Accessory Customer Service at **800-882-0116**, contact your local Moen sales representative, or visit us at www.moen.com.

PRESTON™ Coordinating Bath Accessories

Moen® bath accessories CANNOT be combined with Moen faucet parts on a Purchase Order.

COORDINATING ACCESSORIES

Perfectly suited styles for a cohesive look. From robe hooks to towel bars, Moen offers a wide range of coordinating accessories to complete any room.

MODEL NUMBER	LIST EACH	DESCRIPTION	QTY
Chrome (CH)			
DN8403CH▲	9.05	Double Robe Hook	12
DN8408CH▲	19.30	European Paper Holder	3
DN8418CH▲	25.15	18" Towel Bar	3
DN8422CH▲	41.50	24" Double Towel Bar	3
DN8424CH▲	26.95	24" Towel Bar	1
DN8486CH▲	17.30	Towel Ring	3
DN8490CH▲	45.40	Vanity Shelf	3
Brushed Nickel (BN)			
DN8403BN▲	13.50	Double Robe Hook	12
DN8408BN▲	26.60	European Paper Holder	3
DN8418BN▲	31.15	18" Towel Bar	3
DN8424BN▲	33.20	24" Towel Bar	3
DN8486BN▲	22.35	Towel Ring	3
Matte Black (BL)			
DN8403BL▲	16.70	Double Robe Hook	12 NEW! Q3
DN8408BL▲	29.00	European Paper Holder	3 NEW! Q3
DN8418BL▲	33.95	18" Towel Bar	3 NEW! Q3
DN8424BL▲	36.20	24" Towel Bar	3 NEW! Q3
DN8486BL▲	24.35	Towel Ring	3 NEW! Q3

Product Details

3/4" Round Bar



Double Robe Hook

DN8403



Towel Ring

DN8486



European Paper Holder

DN8408



18" Towel Bar

DN8418

24" Towel Bar

DN8424



24" Double Towel Bar

(CH Only)

DN8422



Vanity Shelf

(CH Only)

DN8490

COORDINATING ACCESSORIES

▲ Retail Packaging

List price is per eachch (unless otherwise noted).

Product can be ordered by case quantity or individually.

For more information on ordering Preston bath accessories or other Moen bath accessories, contact Moen Bath Accessory Customer Service at **800-882-0116**, contact your local Moen sales representative, or visit us at www.moen.com.

ASPEN™ Coordinating Bath Accessories

Moen® bath accessories CANNOT be combined with Moen faucet parts on a Purchase Order.

COORDINATING ACCESSORIES

Perfectly suited styles for a cohesive look. From robe hooks to towel bars, Moen offers a wide range of coordinating accessories to complete any room.

MODEL NUMBER	LIST EACH	DESCRIPTION	QTY
Chrome (CH)			
5802CH	5.95	Single Robe Hook	24
5808CH	13.35	Spring Loaded Paper Holder	3
5818CH	15.65	18" Towel Bar	3
5824CH	17.95	24" Towel Bar	3
5886CH	10.50	Towel Ring	3
BP5808CH	14.40	Spring Loaded Paper Holder	6
BP5824CH	16.60	24" Towel Bar	6
BP5886CH	11.35	Towel Ring	6

Product Details
3/4" Round Bar



Single Robe Hook
5802



Towel Ring
5886
BP5886



Spring Loaded Paper Holder
5808
BP5808



18" Towel Bar
5818
24" Towel Bar
5824
BP5824

COORDINATING
ACCESSORIES

List price is per eachch (unless otherwise noted).
Product can be ordered by case quantity or individually.
For more information on ordering Aspen bath accessories or other Moen bath accessories, contact Moen Bath Accessory Customer Service at **800-882-0116**, contact your local Moen sales representative, or visit us at www.moen.com.

KINGSLEY® Coordinating Bath Accessories

Moen® bath accessories CANNOT be combined with Moen faucet parts on a Purchase Order.

COORDINATING ACCESSORIES

Perfectly suited styles for a cohesive look. From robe hooks to towel bars, Moen offers a wide range of coordinating accessories to complete any room.

MODEL NUMBER	LIST EACH	DESCRIPTION	QTY
Chrome (CH)			
YB5401CH	49.10	Tank Lever	24
YB5403CH	37.80	Double Robe Hook	24
YB5405CH	11.70	Drawer Knob	48
YB5407CH	23.25	Drawer Pull	48
Ⓟ YB5408CH	69.05	Pivoting Paper Holder	6
YB5418CH	74.15	18" Towel Bar	6
YB5422CH	99.35	24" Double Towel Bar	6
YB5424CH	76.60	24" Towel Bar	6
YB5486CH	52.05	Towel Ring	6
YB5490CH	98.60	Vanity Shelf	3
YB5494CH	268.45	Towel Shelf	2
Brushed Nickel (BN)			
YB5401BN	54.20	Tank Lever	24
YB5403BN	41.65	Double Robe Hook	24
YB5405BN	14.65	Drawer Knob	48
YB5407BN	28.95	Drawer Pull	48
Ⓟ YB5408BN	76.40	Pivoting Paper Holder	6
YB5418BN	81.60	18" Towel Bar	6
YB5422BN	107.15	24" Double Towel Bar	6
YB5424BN	84.50	24" Towel Bar	6
YB5486BN	57.00	Towel Ring	6
YB5490BN	106.00	Vanity Shelf	3
YB5494BN	295.90	Towel Shelf	2
Oil Rubbed Bronze (ORB)			
YB5401ORB	59.55	Tank Lever	24
YB5403ORB	45.70	Double Robe Hook	24
YB5405ORB	15.60	Drawer Knob	48
YB5407ORB	31.50	Drawer Pull	48
Ⓟ YB5408ORB	84.00	Pivoting Paper Holder	6
YB5418ORB	89.70	18" Towel Bar	6
YB5422ORB	117.90	24" Double Towel Bar	6
YB5424ORB	93.00	24" Towel Bar	6
YB5486ORB	62.70	Towel Ring	6
YB5490ORB	116.75	Vanity Shelf	3
YB5494ORB	325.45	Towel Shelf	2
Wrought Iron (WR)			
YB5401WR	59.55	Tank Lever	24
YB5403WR	45.70	Double Robe Hook	24
Ⓟ YB5408WR	84.00	Pivoting Paper Holder	6
YB5418WR	89.70	18" Towel Bar	6
YB5422WR	117.90	24" Double Towel Bar	6
YB5424WR	93.00	24" Towel Bar	6
YB5486WR	62.70	Towel Ring	6
YB5490WR	126.10	Vanity Shelf	3



Tank Lever
YB5401



Double Robe Hook
YB5403



Towel Ring
YB5486



Pivoting Paper Holder
YB5408 | Ⓟ



18" Towel Bar
YB5418



24" Double Towel Bar
YB5422



24" Towel Bar
YB5424



Drawer Knob
YB5405



Drawer Pull
YB5407



Towel Shelf
YB5494



Vanity Shelf
YB5490

Ⓟ Denotes pivoting paper holder and mirror

List price is per each (unless otherwise noted).
Product can be ordered by case quantity or individually.
For more information on ordering Kingsley bath accessories or other Moen bath accessories, contact Moen Bath Accessory Customer Service at **800-882-0116**, contact your local Moen sales representative, or visit us at **www.moen.com**.

COORDINATING ACCESSORIES

GILCREST® Coordinating Bath Accessories**Moen® bath accessories CANNOT be combined with Moen faucet parts on a Purchase Order.****COORDINATING ACCESSORIES**

Perfectly suited styles for a cohesive look. From robe hooks to towel bars, Moen offers a wide range of coordinating accessories to complete any room.

MODEL NUMBER	LIST EACH	DESCRIPTION	QTY
Oil Rubbed Bronze (ORB)			
Ⓟ DN0892ORBA	119.65	Pivoting Mirror	3

**Pivoting Mirror**

DN0892 | Ⓟ

COORDINATING
ACCESSORIES

Ⓟ Denotes pivoting paper holder and mirror

List price is per eachch (unless otherwise noted).

Product can be ordered by case quantity or individually.

For more information on ordering Gilcrest bath accessories or other Moen bath accessories, contact Moen Bath Accessory Customer Service at **800-882-0116**, contact your local Moen sales representative, or visit us at **www.moen.com**.**GLENSHIRE®** Coordinating Bath Accessories**Moen® bath accessories CANNOT be combined with Moen faucet parts on a Purchase Order.****COORDINATING ACCESSORIES**

Perfectly suited styles for a cohesive look. From robe hooks to towel bars, Moen offers a wide range of coordinating accessories to complete any room.

MODEL NUMBER	LIST EACH	DESCRIPTION	QTY
Chrome (CH)			
Ⓟ DN2692CHA	102.05	Pivoting Mirror	3
Brushed Nickel (BN)			
Ⓟ DN2692BNA	106.90	Pivoting Mirror	3

**Pivoting Mirror**

DN2692 | Ⓟ

▲ Retail Packaging

Ⓟ Denotes pivoting paper holder and mirror

List price is per eachch (unless otherwise noted).

Product can be ordered by case quantity or individually.

For more information on ordering Glenshire bath accessories or other Moen bath accessories, contact Moen Bath Accessory Customer Service at **800-882-0116**, contact your local Moen sales representative, or visit us at **www.moen.com**.

Donner™ Straight Shower Rod**ALUMINUM ROD WITH ADJUSTABLE FLANGES - 1" DIAMETER**

MODEL	LIST PRICE	DESCRIPTION	FINISH	QTY
52-5	11.90	5 ft. Shower Rod Set - Chrome Plated Flanges	Chrome	50
52-6	13.45	6 ft. Shower Rod Set - Chrome Plated Flanges	Chrome	50
54-5	8.50	5 ft. Shower Rod Set - Chrome Plated Poly Flanges	Chrome	50
54-6	10.10	6 ft. Shower Rod Set - Chrome Plated Poly Flanges	Chrome	50
52-5-OWB	27.45	5 ft. Shower Rod Set - Chrome Plated Flanges	Old World Bronze	10

ALUMINUM ROD WITH NON-ADJUSTABLE FLANGES - 1" DIAMETER

MODEL	LIST PRICE	DESCRIPTION	FINISH	QTY
63-5	11.70	5 ft. Shower Rod Set - Exposed Screw Chrome Plated Flanges	Chrome	50

Product Details

- Corrosion resistant
- Fits 72" x 72" shower curtains

HEAVY-DUTY STAINLESS STEEL RODS WITH ADJUSTABLE FLANGES - 1" DIAMETER

MODEL	LIST PRICE	DESCRIPTION	FINISH	QTY
52-5-SS	18.85	5 ft. Shower Rod Set - Chrome Plated Flanges	Stainless Steel	10
52-5-BN	41.10	6 ft. Shower Rod Set - Chrome Plated Flanges	Brushed Nickel	10

HEAVY-DUTY STAINLESS STEEL RODS WITH NON-ADJUSTABLE FLANGES - 1" DIAMETER

MODEL	LIST PRICE	DESCRIPTION	FINISH	QTY
55-5	48.80	5 ft. Shower Rod Set - Concealed Screw Brushed Stainless Steel Flanges	Polished Stainless	50
58-5	47.10	5 ft. Shower Rod Set - Exposed Screw Brushed Stainless Steel Flanges	Polished Stainless	50
61-5-SS	15.70	5 ft. Shower Rod Set - Concealed Screw Chrome Flanges	Stainless Steel	50
63-5-HD	42.35	5 ft. Fluted Shower Rod Set - Exposed Screw Chrome Flanges	Satin	50
63-5-SS	18.70	5 ft. Shower Rod Set - Exposed Screw Chrome Flanges	Satin	50

Product Details

- Corrosion resistant
- Fits 72" x 72" shower curtains
- 52-5, 55-5 and 61-5-SS: Decorative cover to conceal mounting hardware

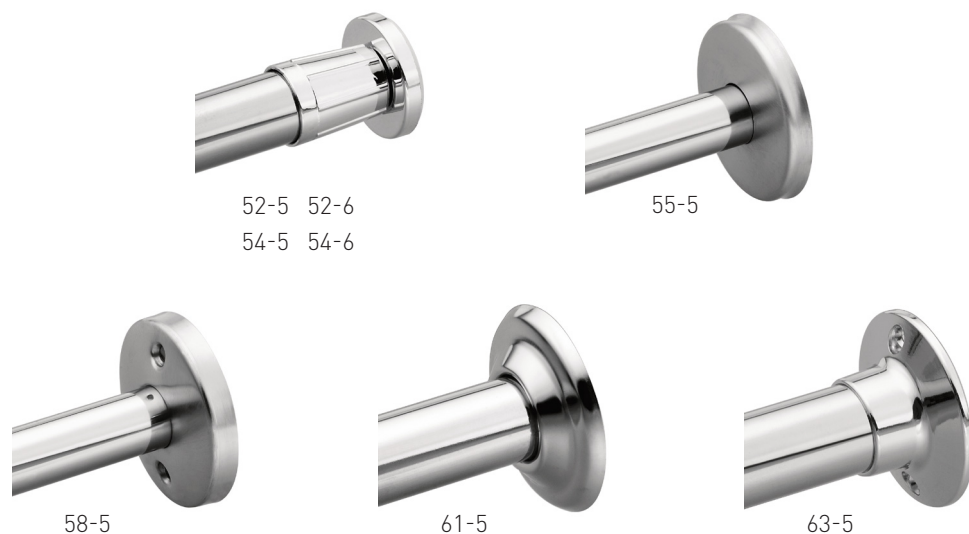

Donner™ Build-Your-Own Straight Shower Rod

STEP #1 : PICK YOUR ROD - ALUMINUM OR STAINLESS - 1" DIAMETER

MODEL	LIST PRICE	DESCRIPTION	FINISH	QTY
2-100-5A	6.95	5 ft. Shower Rod Only - Smooth Aluminum	Chrome	50
2-100-6A	8.70	6 ft. Shower Rod Only - Smooth Aluminum	Chrome	50
2-100-5SS	37.65	5 ft. Shower Rod Only - Polished Stainless Steel 0.35 guage	Stainless Steel	25
2-10155SS	14.10	5 ft. Shower Rod Only - Polished Stainless Steel 0.15 guage	Stainless Steel	25



Aluminum Rods



**Polished
Stainless Steel Rods**

COORDINATING ACCESSORIES

STEP #2 : PICK YOUR FLANGE

MODEL	LIST PRICE	DESCRIPTION	FINISH	QTY
52-F	4.85	Chrome-Plated Adjustable Flange	Chrome	200
54-F	1.45	Chrome-Plated Poly Adjustable Flange	Chrome	200
61-F	1.75	Concealed Screw Flange	Chrome	200
63-F	4.70	Exposed Screw Flange	Chrome	200
55-F	11.25	Concealed Screw Flange	Stainless	50
58-F	9.45	Exposed Screw Flange	Stainless	50



52-F
Chrome-Plated
Adjustable Flange
Shower Rod Flanges Only



54-F
Chrome-Plated
Poly Adjustable Flange
Shower Rod Flanges Only



61-F
Chrome Concealed Flange
Shower Rod Flanges Only



63-F
Chrome Exposed Flange
Shower Rod Flanges Only



55-F
Brushed Stainless Steel
Concealed Flange
Shower Rod Flanges Only



58-F
Brushed Stainless Steel
Exposed Flange
Shower Rod Flanges Only

Donner™ Contemporary

COORDINATING ACCESSORIES

DONNER CONTEMPORARY				
MODEL	LIST PRICE	DESCRIPTION	FINISH	QTY
3C	1.80	Chrome Finished Plastic Roller Only	Chrome	250
3CH	4.85	Chrome Finished Metal Roller Only	Chrome	200
3W	0.30	White Plastic Roller Only	Glacier	250
23418A	1.80	18" Aluminum Towel Bar Only	Chrome	50
23424A	2.25	24" Aluminum Towel Bar Only	Chrome	50
23430A	2.90	30" Aluminum Towel Bar Only	Chrome	50
P5030	2.60	Double Robe Hook	Chrome	100
P5050	5.15	Paper Holder with Chrome Roller	Chrome	100
P5080	4.35	Paper Holder with White Roller	Chrome	100
P5100	4.30	3/4" Chrome Towel Bar Posts for Square Bars (Pair)	Chrome	100
P5118	5.85	18" Towel Bar with Aluminum Bar	Chrome	50
P5124	6.60	24" Towel Bar with Aluminum Bar	Chrome	50
P5340	3.25	Wallmount Toothbrush Holder	Chrome	100
P5360	3.85	Wallmount Soap Holder	Chrome	100
P5500	4.55	Towel Ring / Lucite Ring	Chrome	100
P5860	5.40	Towel Ring / Lucite Ring	Chrome	100
P5030BN	5.10	Double Robe Hook	Brushed Nickel	100
P5050BN	11.70	Paper Holder with Chrome Roller	Brushed Nickel	100
P5080BN	9.60	Paper Holder with White Roller	Brushed Nickel	100
P5118BN	12.70	18" Towel Bar	Brushed Nickel	36
P5124BN	14.05	24" Towel Bar	Brushed Nickel	36
P5130BN	15.15	30" Towel Bar	Brushed Nickel	36
P5860BN	10.15	Towel Ring / Metal Ring	Brushed Nickel	100

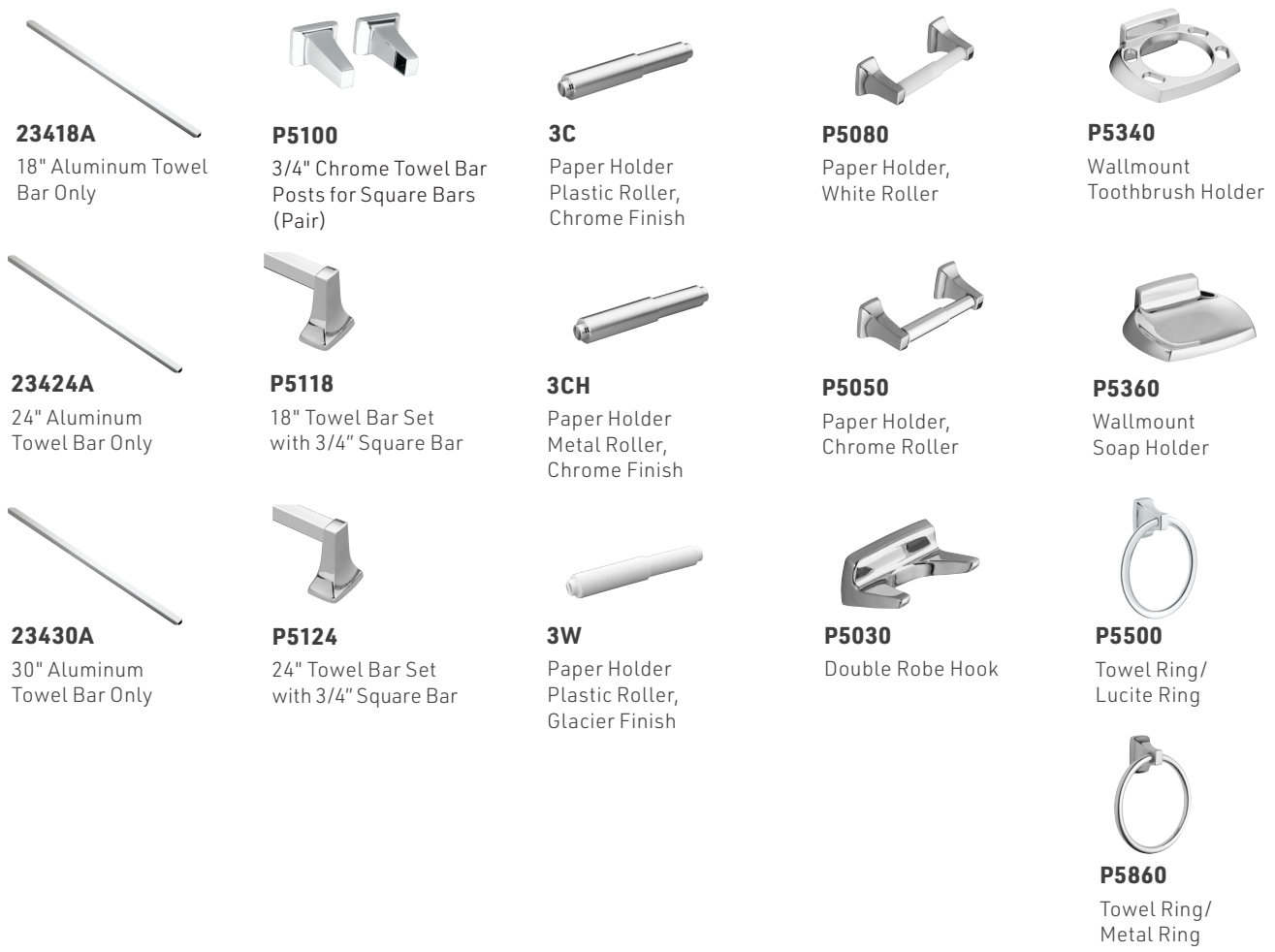

List price is per each (unless otherwise noted). Product can be ordered by case quantity or individually.

Donner™ Stainless Steel

DONNER STAINLESS STEEL				
MODEL	LIST PRICE	DESCRIPTION	FINISH	QTY
23418SS	3.35	18" Towel Bar Only	Stainless	50
23424SS	4.45	24" Towel Bar Only	Stainless	50
23430SS	5.80	30" Towel Bar Only	Stainless	50
P1700	15.70	3/4" Towel Bar Posts (Pair)	Stainless	100
P1703	7.25	Double Robe Hook	Stainless	100
P1718	18.35	18" Towel Bar	Stainless	50
P1724	19.20	24" Towel Bar	Stainless	50
P1780	16.40	Paper Holder with Plastic Roller	Stainless	50
P1786	12.55	Towel Ring	Stainless	100

COORDINATING ACCESSORIES



23418SS
18" Stainless Steel Bar Only

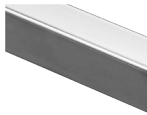

23424SS
24" Stainless Steel Bar Only



23430SS
30" Stainless Steel Bar Only

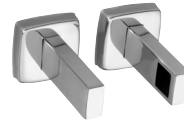

P1700
3/4" Stainless Steel Towel Bar Posts (Pair)



P1703
Double Robe Hook



P1718
18" Towel Bar Set



P1724
24" Towel Bar Set

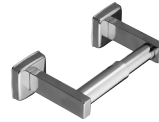

P1780
Paper Holder, Plastic Roller



P1786
Towel Ring

Donner™ Economy Metal

DONNER ECONOMY METAL				
MODEL	LIST PRICE	DESCRIPTION	FINISH	QTY
902	1.90	Single Robe Hook	Chrome	50
908	3.55	Paper Holder with White Roller	Chrome	100
910	3.30	5/8" Square Towel Bar Posts (Pairs)	Chrome	100
910A18	4.55	18" Towel Bar with Aluminum Bar	Chrome	24
910A24	5.10	24" Towel Bar with Aluminum Bar	Chrome	24
950	3.60	Towel Ring / Lucite Ring	Chrome	200
25818A	1.75	18" Aluminum Bar Only	Chrome	50
25824A	2.30	24" Aluminum Bar Only	Chrome	50



902
Single Robe Hook



908
Paper Holder with White Roller



910
5/8" Square Towel Bar Posts (Pair)



910A18
910A24
18" and 24" Towel Bar Set with Aluminum Bar



950
Towel Ring / Lucite Ring



25818A
25824A
18" Towel Bar Only
24" Towel Bar Only

COORDINATING ACCESSORIES

Donner™ Hotel/Motel

DONNER HOTEL/MOTEL				
MODEL	LIST PRICE	DESCRIPTION	FINISH	QTY
R5519	54.40	Stainless Steel 24" Towel Shelf with Extra Bar and Support Bracket (Towel Shelves have chrome-plated brackets with polished stainless steel rods)	Chrome	10
YB0275CH	80.10	Corner Shower Basket	Chrome	6
YB0275BN	88.15	Corner Shower Basket	Brushed Nickel	6
YB0275BL	97.45	Corner Shower Basket	Matte Black	6
RR5520SS	22.90	Recessed Facial Tissue Box, Chrome Finished Fits Wall Opening 10-1/2" x 5" x 2-1/4"	Stainless	24
5520NC	14.40	Recessed Coverless Facial Tissue Box, Fits Wall opening 10-1/2" x 5" x 2-1/4"	Chrome	24
5571	28.10	Recessed Paper Holder - Holds Extra Roll with White Roller, Overall Dimensions 6-1/4" x 6-1/4" - Wall Opening 5-1/4" x 5-1/4" x 4"	Chrome	20
5577	50.25	Recessed Double Paper Holder with Chrome Roller, Horizontal, Overall Dimensions 12-1/2" x 6-1/4" - Wall Opening 11-3/8" x 5-1/4" x 1-1/2"	Chrome	20
RR5506HD	27.45	Heavy Duty Retractable Clothesline, Length 7'6"	Chrome	60
RR5506HDOWB	32.65	Heavy Duty Retractable Clothesline, Length 7'6"	Old World Bronze	60

COORDINATING ACCESSORIES



R5519
24" Towel Shelf with
Extra Bar & Support Bracket



YB0275
Corner Shower Basket



5571
Extra Roll Recessed
Paper Holder

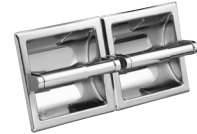

5577
Double Recessed
Paper Holder, Horizontal



RR5520SS
Recessed Tissue Box



5520NC
Recessed Coverless
Tissue Box

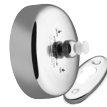

RR5506HD
Heavy-Duty Retractable
Clothesline - Polished
Stainless Steel

Donner™ Recessed Fixtures

DONNER RECESSED FIXTURES				
MODEL	LIST PRICE	DESCRIPTION	FINISH	QTY
575	35.10	Paper Holder with Chrome Roller*	Chrome	20
2565CH	19.45	Soap Holder and Utility Bar*	Chrome	36
2575	19.20	Recessed Paper Holder with Matching Roller*	Chrome	36
DN5075	23.55	Recessed Paper Holder - Includes 588 Installation Clamp	Chrome	3
1576SS	12.40	Paper Holder with White Roller*	Stainless	40
DN5075W	23.55	Recessed Paper Holder - Included 588 Installation Clamp	Glacier	3



575
Paper Holder,
Chrome Roller*



2565CH
Soap Holder
and Utility Bar*



2575
Recessed Paper
Holder,
Matching Roller*



DN5075
Recessed
Paper Holder



1576SS
Paper Holder,
White Roller,
Stainless Steel
Finish*



DN5075W
Recessed
Paper Holder

DONNER HARDWARE				
MODEL	LIST PRICE	DESCRIPTION	FINISH	QTY
588	4.15	C-Clamp (Boxed)	Chrome	80
BR587	4.90	Clamp with Retaining Spring (Box)	N/A	72



588
Installation
C-Clamp (Boxed)



BR587
Installation
Clamp with
Retaining
Spring (Boxed)

*Clamps must be ordered separately.

List price is per each (unless otherwise noted). Product can be ordered by case quantity or individually.

30" Towel Bars

Moen® bath accessories CANNOT be combined with Moen faucet parts on a Purchase Order.

COORDINATING ACCESSORIES

30" TOWEL BAR ONLY - 5/8" DIAMETER

MODEL NUMBER	LIST EACH	FINISH	QTY
DN9830CH	6.00	Chrome	50
DN9830BC	7.60	Brushed Chrome	50
DN9830SN	9.90	Satin Nickel	50
DN9830BN	10.55	Brushed Nickel	50
DN9830NL	15.00	Polished Nickel	50
DN9830ORB	11.45	Oil Rubbed Bronze	50
DN9830BL	9.00	Matte Black	50



30" Towel Bar Only

DN9830

Product Details

- To complete the 30" towel bar set, you must order both a 30" towel bar only and an 18" towel bar (or post only, if available)
- Constructed of aluminum

List price is per eachch (unless otherwise noted).

Product can be ordered by case quantity or individually.

For more information on ordering bath accessories or other Moen bath accessories, contact Moen Bath Accessory Customer Service at **800-882-0116**, contact your local Moen sales representative, or visit us at www.moen.com.

COORDINATING
ACCESSORIES



SHOWER RODS AND RINGS



Add an elegant and luxurious look while also creating a more comfortable experience in the bath with a choice of shower rods and rings. Moen rods and rings are available in several of today's most popular finishes. These rods are featured in straight and curved styles giving you the room you need in the shower.

Shower Rods and Rings

COORDINATING
ACCESSORIES

Double Curved
Adjustable Curved
Fixed Length
Tension Curved
Decorative Tension
Shower Rings

**ADJUSTABLE DOUBLE CURVED SHOWER RODS**

MODEL	LIST PRICE	FINISH	QTY
DN2141CH▲	83.80	Chrome	2
DN2141BN▲	84.50	Brushed Nickel	2
DN2141NL	176.05	Polished Nickel	6
DN2141OWB▲	106.30	Old World Bronze	2
DN2141BL	109.00	Matte Black	6



Double Curved Shower Rod
DN2141

Product Details

- 430 Stainless Steel
- Provides up to 5.5" more elbow room in the shower
- Adjusts from 57" to 60"
- Corrosion-resistant
- Drywall anchors included
- Works with standard 72" x 72" shower curtains

▲ Retail Packaging

Shower curtains and shower curtain rings are not included with shower curtain rods. Moen® shower curtain rings can be purchased separately. See page 508. List price is per each (unless otherwise noted). Product can be ordered by case quantity or individually.

Shower Rods and Rings

ADJUSTABLE CURVED SHOWER RODS

MODEL	LIST PRICE	FINISH	QTY
CSR2160CH	66.65	Chrome	10
CSR2160BN	67.90	Brushed Nickel	10
CSR2160BG	97.90	Brushed Gold	10
CSR2160NL	133.40	Polished Nickel	10
CSR2160OWB	83.85	Old World Bronze	10
CSR2160BL	100.05	Matte Black	10
CSR2164CH	68.15	Chrome	10
CSR2164BN	75.00	Brushed Nickel	10
CSR2164BG	104.90	Brushed Gold	10
CSR2164NL	136.40	Polished Nickel	10
CSR2164OWB	85.75	Old World Bronze	10
CSR2164BL	102.30	Matte Black	10

Product Details

- 304 Stainless Steel
- Adjusts between 54" to 72"
- Weight load capacity of 120 lbs. (based on independent lab testing)
- Mounting flange pivots 180 degrees for easy installation
- Corrosion-resistant
- Drywall anchors included
- No cutting required

**Adjustable Curved Shower Rod**

CSR2160

**Adjustable Curved Shower Rod**

CSR2164

ADJUSTABLE CURVED SHOWER RODS - LOW PROFILE

MODEL	LIST PRICE	FINISH	QTY
CSR2168CH	63.45	Chrome	10
CSR2168BN	69.90	Brushed Nickel	10
CSR2168BL	91.35	Matte Black	10

Product Details

- 304 Stainless Steel
- Adjusts between 54" to 60"
- Weight load capacity of 120 lbs. (based on independent lab testing)
- Mounting flange pivots 180 degrees for easy installation
- Corrosion-resistant
- Drywall anchors included
- No cutting required

**Low-Profile Adjustable Curved Shower Rod**

CSR2168

Shower Rods and Rings

FIXED-LENGTH DECORATIVE CURVED SHOWER ROD SET - PIVOTING

MODEL	LIST PRICE	DESCRIPTION	FINISH	QTY
CSR2165CH	52.70	5 ft. Shower Rod Set	Chrome	10
CSR2165BN	56.45	5 ft. Shower Rod Set	Brushed Nickel	10
CSR2165OWB	67.80	5 ft. Shower Rod Set	Old World Bronze	10
CSR2166CH	60.30	6 ft. Shower Rod Set	Chrome	10
CSR2166BN	64.85	6 ft. Shower Rod Set	Brushed Nickel	10



**Fixed-Length
Decorative Curved
Shower Rod –
Pivoting Flanges**
CSR2165 / CSR2166

FIXED-LENGTH DECORATIVE CURVED SHOWER ROD SET - NON-PIVOTING

MODEL	LIST PRICE	DESCRIPTION	FINISH	QTY
CSR2155CH	59.35	5 ft. Shower Rod Set	Chrome	10
CSR2155BN	63.35	5 ft. Shower Rod Set	Brushed Nickel	10
CSR2155OWB	74.85	5 ft. Shower Rod Set	Old World Bronze	10



**Fixed-Length
Decorative Curved
Shower Rod –
Non-Pivoting Flanges**
CSR2155

Product Details

- Provides extra elbow room in the shower
- Corrosion-resistant
- Drywall anchors included
- CSR2165 | CSR2166 : Mounting flange pivots 180 degrees for easy installation

FIXED-LENGTH LOW PROFILE SHOWER ROD SET - PIVOTING

MODEL	LIST PRICE	DESCRIPTION	FINISH	QTY
CSR2167CH	51.80	5 ft. Low-Profile Shower Rod Set	Chrome	10
CSR2167BN	60.45	5 ft. Low-Profile Shower Rod Set	Brushed Nickel	10
CSR2167BL	74.65	5 ft. Low-Profile Shower Rod Set	Matte Black	10



**Fixed-Length
Low-Profile Curved
Shower Rod – Pivoting**
CSR2167

FIXED-LENGTH LOW PROFILE SHOWER ROD SET - NON-PIVOTING

MODEL	LIST PRICE	DESCRIPTION	FINISH	QTY
CSR2145CH	54.40	5 ft. Low-Profile Shower Rod Set	Chrome	10
CSR2145BN	63.50	5 ft. Low-Profile Shower Rod Set	Brushed Nickel	10



**Fixed-Length
Low-Profile Curved
Shower Rod – Non-Pivoting**
CSR2145

Product Details

- Provides extra elbow room in the shower
- Corrosion-resistant
- Drywall anchors included

Shower Rods and Rings

COORDINATING ACCESSORIES

FIXED-LENGTH CURVED SHOWER ROD ONLY*

MODEL	LIST PRICE	DESCRIPTION	FINISH	QTY
2-102-5PS	27.80	5 ft. Rod Only	Polished Stainless	25
2-102-5BS	29.15	5 ft. Rod Only	Brushed Stainless	25



Fixed-Length Curved Shower Rod Only

2-102-5*

LOW-PROFILE FLANGE ONLY* - NON-PIVOTING

MODEL	LIST PRICE	DESCRIPTION	FINISH	QTY
65-F-BS	22.80	Flange Only	Brushed Stainless	25
65-F-PS	19.80	Flange Only	Polished Stainless	25



Low-Profile Non-Pivoting Flange

65-F

Product Details

- Shower rod provides extra elbow room in the shower
- Corrosion-resistant
- *For complete shower rod set, order both the curved shower rod and low profile flange kit.

TENSION CURVED SHOWER RODS

MODEL	LIST PRICE	DESCRIPTION	FINISH	QTY
CSR2172CH	61.70	Curved Shower Rod Set	Chrome	10
CSR2172BN	67.90	Curved Shower Rod Set	Brushed Nickel	10



Tension Curved Shower Rod

CSR2172

Product Details

- Adjusts between 57" to 60"
- Corrosion-resistant
- Works with standard 72" x 72" shower curtains
- Easy installation: expand the bar to the correct size, apply tension and snap on the decorative covers

DECORATIVE TENSION STRAIGHT SHOWER RODS

MODEL	LIST PRICE	DESCRIPTION	FINISH	QTY
TR1000CH▲	38.85	Straight Shower Rod Set	Chrome	3
TR1000BN▲	38.85	Straight Shower Rod Set	Brushed Nickel	3
TR1000WBA▲	38.85	Straight Shower Rod Set	Old World Bronze	3
TR1000BL▲	42.75	Straight Shower Rod Set	Matte Black	3
TR1032BN▲	54.65	Straight Shower Rod Set	Brushed Nickel	3

NEW! Q3

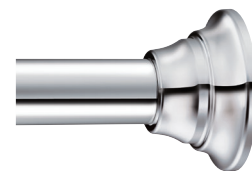

Tension Rod

TR1000

Product Details

- Adjusts between 44" to 72"
- Corrosion-resistant
- FastLock™ technology: no tools, no additional hardware, no long installation



Tension Rod

TR1032

▲ Retail Packaging

Shower curtains and shower curtain rings are not included with shower curtain rods. Moen shower curtain rings can be purchased separately. See page 508.

List price is per each (unless otherwise noted). Product can be ordered by case quantity or individually.

Shower Rods and Rings

DOUBLE SHOWER CURTAIN SHOWER RINGS

MODEL	LIST PRICE	DESCRIPTION	FINISH	QTY
SR2201CH▲	18.80	Double Shower Curtain Rings	Chrome	12
SR2201BN▲	21.70	Double Shower Curtain Rings	Brushed Nickel	12
SR2201NL	30.50	Double Shower Curtain Rings	Polished Nickel	24
SR2201OWBA	22.00	Double Shower Curtain Rings	Old World Bronze	12
SR2201BL	30.50	Double Shower Curtain Rings	Matte Black	24



**Double
Shower Rings**
SR2201

Product Details

- Smooth rolling ball bearings eliminates snagging, tugging and pulling
- Allows you to separate the shower curtain from the shower liner
- Corrosion resistant
- Fits most shower curtains and rod types

COORDINATING
ACCESSORIES

SINGLE SHOWER CURTAIN SHOWER RINGS

MODEL	LIST PRICE	DESCRIPTION	FINISH	QTY
SR2100CH	15.10	Single Shower Curtain Rings	Chrome	25
SR2100BN	17.30	Single Shower Curtain Rings	Brushed Nickel	25
SR2100WB	17.55	Single Shower Curtain Rings	Old World Bronze	25



**Single
Shower Rings**
SR2100

Product Details

- Smooth rolling ball bearings eliminates snagging, tugging and pulling
- Corrosion resistant
- Fits most shower curtains and rod types

▲ Retail Packaging

List price is per each (unless otherwise noted). Product can be ordered by case quantity or individually.

Flara™

Colinet™

90°®

Greenfield™

Belfield™

Voss™

Brantford®

Eva®

Iso™

Moen Lighting

Whether your tastes lean traditional, modern or somewhere in between, Moen offers a bath lighting choice that will fit your style. Our distinctive lighting options are designed to accent some of our leading faucets. With nine collections to choose from, it's never been easier to tie together the look of your bathroom. Built in the Moen tradition, our lighting offers quality, durability and style.



COORDINATING ACCESSORIES

FLARA™			
MODEL	LIST PRICE	DESCRIPTION	QTY
PREMIUM			
Chrome (CH)			
YB0361CH	232.80	One Globe Bath Light	2
YB0362CH	325.65	Two Globe Bath Light	2
YB0363CH	404.50	Three Globe Bath Light	2
YB0364CH	505.60	Four Globe Bath Light	2
Brushed Nickel (BN)			
YB0361BN	302.60	One Globe Bath Light	2
YB0362BN	423.35	Two Globe Bath Light	2
YB0363BN	525.80	Three Globe Bath Light	2
YB0364BN	657.30	Four Globe Bath Light	2
Brushed Gold (BG)			
YB0361BG	363.10	One Globe Bath Light	2
YB0362BG	508.10	Two Globe Bath Light	2
YB0363BG	630.95	Three Globe Bath Light	2
YB0364BG	788.60	Four Globe Bath Light	2
Polished Nickel (NL)			
YB0361NL	332.85	One Globe Bath Light	2
YB0362NL	465.75	Two Globe Bath Light	2
YB0363NL	578.35	Three Globe Bath Light	2
YB0364NL	722.95	Four Globe Bath Light	2
Replacement Globe			
YB0369	40.10	Replacement Globe	3



One Globe Bath Light
YB0361



Two Globe Bath Light
YB0362



Three Globe Bath Light
YB0363



Four Globe Bath Light
YB0364



Replacement Globe
YB0369



Bulbs not included.

All Flara lighting fixtures can be mounted with globes either facing upward or downward. List price is per each (unless otherwise noted). Product can be ordered by case quantity or individually.

Moen Lighting

COORDINATING ACCESSORIES

COLINET™

MODEL	LIST PRICE	DESCRIPTION	QTY
-------	------------	-------------	-----

PREMIUM

Chrome (CH)

YB0561CH	232.90	One Globe Bath Light	2
YB0562CH	325.90	Two Globe Bath Light	2
YB0563CH	404.70	Three Globe Bath Light	2
YB0564CH	505.80	Four Globe Bath Light	2

Brushed Nickel (BN)

YB0561BN	302.70	One Globe Bath Light	2
YB0562BN	423.65	Two Globe Bath Light	2
YB0563BN	526.05	Three Globe Bath Light	2
YB0564BN	657.55	Four Globe Bath Light	2

Brushed Gold (BG)

YB0561BG	349.35	One Globe Bath Light	2
YB0562BG	488.90	Two Globe Bath Light	2
YB0563BG	607.00	Three Globe Bath Light	2
YB0564BG	758.75	Four Globe Bath Light	2

Matte Black (BL)

YB0561BL	333.00	One Globe Bath Light	2
YB0562BL	466.00	Two Globe Bath Light	2
YB0563BL	578.65	Three Globe Bath Light	2
YB0564BL	723.30	Four Globe Bath Light	2

Replacement Globe

YB0569	41.95	Replacement Globe	3
--------	-------	-------------------	---



One Globe Bath Light

YB0561



Two Globe Bath Light

YB0562



Three Globe Bath Light

YB0563



Four Globe Bath Light

YB0564



Replacement Globe

YB0569

90°®

MODEL	LIST PRICE	DESCRIPTION	QTY
-------	------------	-------------	-----

PREMIUM

Chrome (CH)

YB8861CH	213.45	One Globe Bath Light	2
YB8862CH	298.60	Two Globe Bath Light	2
YB8863CH	370.85	Three Globe Bath Light	2
YB8864CH	475.05	Four Globe Bath Light	2

Brushed Nickel (BN)

YB8861BN	266.70	One Globe Bath Light	2
YB8862BN	373.35	Two Globe Bath Light	2
YB8863BN	463.85	Three Globe Bath Light	2
YB8864BN	593.75	Four Globe Bath Light	2

Matte Black (BL)

YB8861BL	290.70	One Globe Bath Light	2	NEW! Q3
YB8862BL	406.95	Two Globe Bath Light	2	NEW! Q3
YB8863BL	505.60	Three Globe Bath Light	2	NEW! Q3
YB8864BL	647.15	Four Globe Bath Light	2	NEW! Q3

Replacement Globe

YB8869	39.20	Replacement Globe	3
--------	-------	-------------------	---



One Globe Bath Light

YB8861



Two Globe Bath Light

YB8862



Three Globe Bath Light

YB8863



Four Globe Bath Light

YB8864



Replacement Globe

YB8869



Bulbs not included.

Moen Lighting

GREENFIELD™ **NEW!** Q3

MODEL	LIST PRICE	DESCRIPTION	QTY
Chrome (CH)			
YB1761CH	177.10	One Globe Bath Light	1 NEW! Q3
YB1762CH	247.80	Two Globe Bath Light	1 NEW! Q3
YB1763CH	307.80	Three Globe Bath Light	1 NEW! Q3
YB1764CH	394.10	Four Globe Bath Light	1 NEW! Q3
Brushed Nickel (BN)			
YB1761BN	221.45	One Globe Bath Light	1 NEW! Q3
YB1762BN	309.75	Two Globe Bath Light	1 NEW! Q3
YB1763BN	384.70	Three Globe Bath Light	1 NEW! Q3
YB1764BN	492.65	Four Globe Bath Light	1 NEW! Q3
Brushed Gold (BG)			
YB1761BG	265.80	One Globe Bath Light	1 NEW! Q3
YB1762BG	371.70	Two Globe Bath Light	1 NEW! Q3
YB1763BG	461.70	Three Globe Bath Light	1 NEW! Q3
YB1764BG	591.15	Four Globe Bath Light	1 NEW! Q3
Matte Black (BL)			
YB1761BL	241.40	One Globe Bath Light	1 NEW! Q3
YB1762BL	337.60	Two Globe Bath Light	1 NEW! Q3
YB1763BL	419.30	Three Globe Bath Light	1 NEW! Q3
YB1764BL	537.00	Four Globe Bath Light	1 NEW! Q3
Replacement Globe			
YB1769	32.45	Replacement Globe	3 NEW! Q3



One Globe Bath Light
YB1761



Two Globe Bath Light
YB1762



Three Globe Bath Light
YB1763



Four Globe Bath Light
YB1764



Replacement Globe
YB1769

COORDINATING ACCESSORIES

BELFIELD™

MODEL	LIST PRICE	DESCRIPTION	QTY
Chrome (CH)			
YB6461CH	177.90	One Globe Bath Light	1
YB6462CH	248.85	Two Globe Bath Light	1
YB6463CH	308.90	Three Globe Bath Light	1
YB6464CH	395.65	Four Globe Bath Light	1
Brushed Nickel (BN)			
YB6461BN	222.30	One Globe Bath Light	1
YB6462BN	311.00	Two Globe Bath Light	1
YB6463BN	386.20	Three Globe Bath Light	1
YB6464BN	494.60	Four Globe Bath Light	1
Polished Nickel (NL)			
YB6461NL	215.35	One Globe Bath Light	1
YB6462NL	301.35	Two Globe Bath Light	1
YB6463NL	386.20	Three Globe Bath Light	1
YB6464NL	513.60	Four Globe Bath Light	1
Oil Rubbed Bronze (ORB)			
YB6461ORB	222.30	One Globe Bath Light	1
YB6462ORB	311.00	Two Globe Bath Light	1
YB6463ORB	386.20	Three Globe Bath Light	1
YB6464ORB	494.60	Four Globe Bath Light	1
Matte Black (BL)			
YB6461BL	215.35	One Globe Bath Light	1
YB6462BL	301.35	Two Globe Bath Light	1
YB6463BL	402.10	Three Globe Bath Light	1
YB6464BL	513.60	Four Globe Bath Light	1
Replacement Globe			
YB6469	32.65	Replacement Globe	3



One Globe Bath Light
YB6461



Two Globe Bath Light
YB6462



Three Globe Bath Light
YB6463



Four Globe Bath Light
YB6464



Replacement Globe
YB6469

All Greenfield and Belfield lighting fixtures can be mounted with globes either facing upward or downward. Greenfield two globe bath lighting can be mounted either facing vertically or horizontally without the need to remove the rings.

List price is per each (unless otherwise noted). Product can be ordered by case quantity or individually.



Bulbs not included.

Moen Lighting

COORDINATING ACCESSORIES

VOSS™

MODEL	LIST PRICE	DESCRIPTION	QTY
-------	------------	-------------	-----

Chrome (CH)

YB5161CH	177.10	One Globe Bath Light	2
YB5162CH	247.80	Two Globe Bath Light	2
YB5163CH	307.80	Three Globe Bath Light	2
YB5164CH	394.10	Four Globe Bath Light	2

Brushed Nickel (BN)

YB5161BN	221.45	One Globe Bath Light	2
YB5162BN	309.75	Two Globe Bath Light	2
YB5163BN	384.70	Three Globe Bath Light	2
YB5164BN	492.65	Four Globe Bath Light	2

Brushed Gold (BG)

YB5161BG	265.80	One Globe Bath Light	2
YB5162BG	371.70	Two Globe Bath Light	2
YB5163BG	461.70	Three Globe Bath Light	2
YB5164BG	591.15	Four Globe Bath Light	2

Polished Nickel (NL)

YB5161NL	221.55	One Globe Bath Light	2
YB5162NL	322.55	Two Globe Bath Light	2
YB5163NL	415.90	Three Globe Bath Light	2
YB5164NL	532.65	Four Globe Bath Light	2

Oil Rubbed Bronze (ORB)

YB5161ORB	221.45	One Globe Bath Light	2
YB5162ORB	309.75	Two Globe Bath Light	2
YB5163ORB	384.70	Three Globe Bath Light	2
YB5164ORB	492.65	Four Globe Bath Light	2

Matte Black (BL)

YB5161BL	221.45	One Globe Bath Light	2	NEW! Q3
YB5162BL	309.75	Two Globe Bath Light	2	NEW! Q3
YB5163BL	384.70	Three Globe Bath Light	2	NEW! Q3
YB5164BL	492.65	Four Globe Bath Light	2	NEW! Q3

Replacement Globe

YB5169	32.45	Replacement Globe	3
--------	-------	-------------------	---



One Globe Bath Light
YB5161



Two Globe Bath Light
YB5162



Three Globe Bath Light
YB5163



Four Globe Bath Light
YB5164



Replacement Globe
YB5169

BRANTFORD®

MODEL	LIST PRICE	DESCRIPTION	QTY
-------	------------	-------------	-----

Chrome (CH)

YB2261CH	147.20	One Globe Bath Light	2
YB2262CH	206.10	Two Globe Bath Light	2
YB2263CH	255.90	Three Globe Bath Light	2
YB2264CH	327.80	Four Globe Bath Light	2

Brushed Nickel (BN)

YB2261BN	184.10	One Globe Bath Light	2
YB2262BN	257.70	Two Globe Bath Light	2
YB2263BN	319.95	Three Globe Bath Light	2
YB2264BN	409.65	Four Globe Bath Light	2

Oil Rubbed Bronze (ORB)

YB2261ORB	184.10	One Globe Bath Light	2
YB2262ORB	257.70	Two Globe Bath Light	2
YB2263ORB	319.95	Three Globe Bath Light	2
YB2264ORB	409.65	Four Globe Bath Light	2

Replacement Globe

YB2269	27.60	Replacement Globe	3
--------	-------	-------------------	---



One Globe Bath Light
YB2261



Two Globe Bath Light
YB2262



Three Globe Bath Light
YB2263



Four Globe Bath Light
YB2264



Replacement Globe
YB2269



Bulbs not included.

Moen Lighting

EVA®			
MODEL	LIST PRICE	DESCRIPTION	QTY
Chrome (CH)			
YB2861CH	147.20	One Globe Bath Light	2
YB2862CH	206.10	Two Globe Bath Light	2
YB2863CH	255.90	Three Globe Bath Light	2
YB2864CH	327.80	Four Globe Bath Light	2
Brushed Nickel (BN)			
YB2861BN	184.10	One Globe Bath Light	2
YB2862BN	257.70	Two Globe Bath Light	2
YB2863BN	319.95	Three Globe Bath Light	2
YB2864BN	409.65	Four Globe Bath Light	2
Oil Rubbed Bronze (ORB)			
YB2861ORB	184.10	One Globe Bath Light	2
YB2862ORB	257.70	Two Globe Bath Light	2
YB2863ORB	319.95	Three Globe Bath Light	2
YB2864ORB	409.65	Four Globe Bath Light	2
Replacement Globe			
YB2869	27.60	Replacement Globe	3



One Globe Bath Light
YB2861



Two Globe Bath Light
YB2862



Three Globe Bath Light
YB2863



Four Globe Bath Light
YB2864



Replacement Globe
YB2869

ISO™			
MODEL	LIST PRICE	DESCRIPTION	QTY
Chrome (CH)			
DN0761CH	146.85	One Globe Bath Light	2
DN0762CH	209.50	Two Globe Bath Light	2
DN0763CH	257.10	Three Globe Bath Light	2
DN0764CH	329.35	Four Globe Bath Light	2
Brushed Nickel (BN)			
DN0761BN	184.90	One Globe Bath Light	2
DN0762BN	258.90	Two Globe Bath Light	2
DN0763BN	321.45	Three Globe Bath Light	2
DN0764BN	411.55	Four Globe Bath Light	2
Brushed Gold (BG)			
DN0761BG	221.85	One Globe Bath Light	2
DN0762BG	310.60	Two Globe Bath Light	2
DN0763BG	385.70	Three Globe Bath Light	2
DN0764BG	493.85	Four Globe Bath Light	2
Matte Black (BL)			
DN0761BL	177.90	One Globe Bath Light	2
DN0762BL	253.75	Two Globe Bath Light	2
DN0763BL	311.35	Three Globe Bath Light	2
DN0764BL	398.85	Four Globe Bath Light	2
Replacement Globe			
DN0769	27.10	Replacement Globe	3



One Globe Bath Light
DN0761



Two Globe Bath Light
DN0762



Three Globe Bath Light
DN0763



Four Globe Bath Light
DN0764



Replacement Globe
DN0769

COORDINATING ACCESSORIES



Bulbs not included.

All Iso and Eva lighting fixtures can be mounted with globes either facing upward or downward. List price is per each (unless otherwise noted). Product can be ordered by case quantity or individually.

Moen Knobs & Pulls

COORDINATING ACCESSORIES

Weymouth®

Flara™

Colinet™

90°®

Kingsley®

Iso™

Moen Knobs and Pulls

With our distinctive collection of knobs and pulls, you can create a perfectly matched bath or kitchen and carry your style throughout the room.



WEYMOUTH®

MODEL	LIST PRICE	DESCRIPTION	QTY
-------	------------	-------------	-----

PREMIUM

Chrome (CH)

YB8405CH	22.35	Drawer Knob	48
YB8407CH	41.75	Drawer Pull	48

Brushed Nickel (BN)

YB8405BN	25.25	Drawer Knob	48
YB8407BN	44.60	Drawer Pull	48

Brushed Gold (BG)

YB8405BG	30.30	Drawer Knob	48
YB8407BG	53.55	Drawer Pull	48

Polished Nickel (NL)

YB8405NL	27.75	Drawer Knob	48
YB8407NL	49.05	Drawer Pull	48

Oil Rubbed Bronze (ORB)

YB8405ORB	27.75	Drawer Knob	48
YB8407ORB	49.05	Drawer Pull	48

Matte Black (BL)

YB8405BL	27.75	Drawer Knob	48
YB8407BL	48.85	Drawer Pull	48



Drawer Knob
YB8405



Drawer Pull
YB8407

FLARA™

MODEL	LIST PRICE	DESCRIPTION	QTY
-------	------------	-------------	-----

PREMIUM

Chrome (CH)

YB0305CH	18.25	Drawer Knob	48
YB0307CH	36.60	Drawer Pull	48

Brushed Nickel (BN)

YB0305BN	23.75	Drawer Knob	48
YB0307BN	47.65	Drawer Pull	48

Brushed Gold (BG)

YB0305BG	28.50	Drawer Knob	48
YB0307BG	57.20	Drawer Pull	48

Polished Nickel (NL)

YB0305NL	20.10	Drawer Knob	48
YB0307NL	52.40	Drawer Pull	48



Drawer Knob
YB0305



Drawer Pull
YB0307

Moen Knobs & Pulls

COLINET™

MODEL	LIST PRICE	DESCRIPTION	QTY
PREMIUM			
Chrome (CH)			
YB0505CH	18.25	Drawer Knob	48
YB0507CH	36.65	Drawer Pull	48
Brushed Nickel (BN)			
YB0505BN	23.75	Drawer Knob	48
YB0507BN	47.70	Drawer Pull	48
Brushed Gold (BG)			
YB0505BG	27.45	Drawer Knob	48
YB0507BG	55.05	Drawer Pull	48
Matte Black (BL)			
YB0505BL	26.20	Drawer Knob	48
YB0507BL	52.40	Drawer Pull	48



Drawer Knob
YB0505



Drawer Pull
YB0507

90°®

MODEL	LIST PRICE	DESCRIPTION	QTY
PREMIUM			
Chrome (CH)			
YB8805CH	16.80	Drawer Knob	48
YB8807CH	33.65	Drawer Pull	48
Brushed Nickel (BN)			
YB8805BN	19.40	Drawer Knob	48
YB8807BN	36.35	Drawer Pull	48
Matte Black (BL)			
YB8805BL	21.15	Drawer Knob	48 NEW! Q3
YB8807BL	39.60	Drawer Pull	48 NEW! Q3



Drawer Knob
YB8805



Drawer Pull
YB8807

**COORDINATING
ACCESSORIES**

Moen Knobs & Pulls

COORDINATING ACCESSORIES

KINGSLEY®

MODEL	LIST PRICE	DESCRIPTION	QTY
Chrome (CH)			
YB5405CH	11.70	Drawer Knob	48
YB5407CH	23.25	Drawer Pull	48
Brushed Nickel (BN)			
YB5405BN	14.65	Drawer Knob	48
YB5407BN	28.95	Drawer Pull	48
Oil Rubbed Bronze (ORB)			
YB5405ORB	15.60	Drawer Knob	48
YB5407ORB	31.50	Drawer Pull	48



Drawer Knob
YB5405



Drawer Pull
YB5407

ISO™

MODEL	LIST PRICE	DESCRIPTION	QTY
Chrome (CH)			
DN0705CH	10.95	Drawer Knob	48
DN0707CH	21.85	Drawer Pull	48
Brushed Nickel (BN)			
DN0705BN	12.80	Drawer Knob	48
DN0707BN	23.55	Drawer Pull	48
Brushed Gold (BG)			
DN0705BG	15.35	Drawer Knob	48
DN0707BG	28.20	Drawer Pull	48
Matte Black (BL)			
DN0705BL	13.30	Drawer Knob	48
DN0707BL	26.40	Drawer Pull	48



Drawer Knob
DN0705



Drawer Pull
DN0707

BATH SAFETY



While bath safety is often only considered for older adults, it should be for all stages of life. From babies to boomers, Moen offers a full range of products to make baths safe and stylish.

Grab Bar Guide

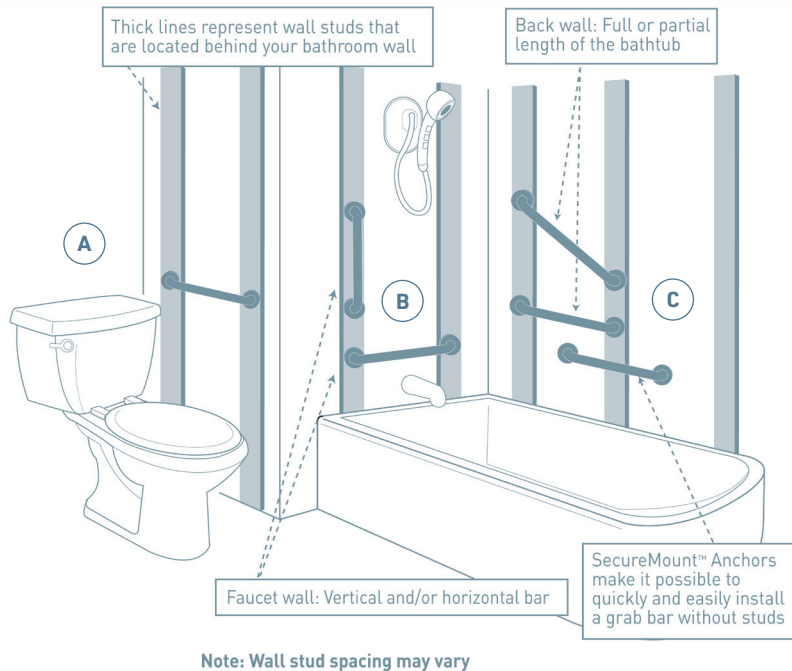

HOW MANY GRAB BARS DO I NEED AND WHERE SHOULD THEY BE INSTALLED?

Health professionals typically recommend three grab bars in a bathroom:

- A** At least one near the toilet
- B** At least one along the showerhead wall or whichever end of the tub/shower you use to enter/exit
- C** At least one along the back wall in the bathtub or shower

WHO SHOULD USE GRAB BARS?

Everyone! People of all ages and abilities can benefit from using grab bars.

WHAT CAN A GRAB BAR DO?

- Reduce risk of falling in the tub or shower
- Help steady yourself while getting into and out of the bathtub or shower
- Assist in safely lowering and raising from a seated position

THINGS TO CONSIDER WHEN SELECTING A GRAB BAR(S):

- **Length:** Select a grab bar that is the suitable length for your bath or shower area.
- **Weight Capacity:** Choose a grab bar that at least meets ADA requirements (250 lbs.); SecureMount™ Grab Bars have a 500-pound weight-pull capacity that exceeds ADA requirements (when securely installed into studs).
- **Installation:** Grab bars that feature SecureMount™ have a design that allows for secure installation into a stud or wood backing at any angle. When using SecureMount™ Anchors, there is no need for installation into a stud or wood backing.
- **Grip Surface:** Consider a grab bar with a textured surface or grip feature that provides a better hold in a wet bathroom environment.
- **Finish:** Consider a grab bar that matches your faucet and other fixtures.

SECUREMOUNT™ SYSTEM



SecureMount Anchors and Plates

1 Pair Pack SMA1000 |  10 Pair Pack SMA1001 | 

SecureMount System

The SecureMount System is the ultimate choice in easy, secure grab bar installation.

SecureMount Grab bars

The unique flange makes it easy to connect to the stud at multiple points, at any angle.

SecureMount Anchors

Precision-engineered for optimal bracing behind the wall, SecureMount Anchors allow for easy grab bar installation—with no studs required—anywhere on the wall.

16" grab bars can typically mount directly into studs because the standard stud size is 16" on center. 18", 24", 36" and 42" grab bars will often need an anchoring system when mounted into drywall, as an alternative to stud or wood-block installation.

FINISH OPTIONS

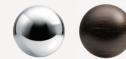

Chrome (C/CH), Old World Bronze (OWB)

Product Details:

- 300 lb. weight capacity when securely installed per instructions. Limited Lifetime Warranty. Independently tested by CSA and NAHB laboratories to exceed ADA, ASTM, ANSI and CSA standards.
- Mount securely to a variety of substrates*:
 - 1/2" or 5/8" drywall
 - 1/2" or 5/8" drywall with tile
 - 1/2" or 5/8" drywall with marble
 - 1/8" or 1/4" fiberglass tub surround

Not all platforms available in all finishes.

COORDINATING
ACCESSORIES

Grab Bars

COORDINATING ACCESSORIES

- Arris®
- Flara™
- 90°™
- Align®
- Voss™
- Belfield™
- Kingsley®
- Brantford®
- Eva®
- Genta™
- Iso™

Grab Bars

With our broad collection of grab bars and bath safety products, there's no need to sacrifice style for safety. Create a perfectly matched bath with grab bars in a variety of styles and finishes. Further enhance bath safety with a choice of products for the toilet, tub and shower.



ARRIS® GRAB BARS - 1 1/4" DIAMETER CONCEALED SCREW

MODEL	LIST PRICE	DESCRIPTION	FINISH	QTY
PREMIUM				
Chrome (CH)				
YG0812CH	202.20	12" Designer Grab Bar	Chrome	6
YG0818CH	211.25	18" Designer Grab Bar	Chrome	6
YG0824CH	220.75	24" Designer Grab Bar	Chrome	6
YG0836CH	251.25	36" Designer Grab Bar	Chrome	6
YG0842CH	351.65	42" Designer Grab Bar	Chrome	6
Matte Black (BL)				
YG0812BL	244.20	12" Designer Grab Bar	Matte Black	6
YG0818BL	255.20	18" Designer Grab Bar	Matte Black	6
YG0824BL	266.65	24" Designer Grab Bar	Matte Black	6
YG0836BL	303.65	36" Designer Grab Bar	Matte Black	6
YG0842BL	424.85	42" Designer Grab Bar	Matte Black	6



24" Designer Grab Bar

YG0824 | 

COORDINATING ACCESSORIES

FLARA™ GRAB BARS - 1 1/4" DIAMETER CONCEALED SCREW

MODEL	LIST PRICE	DESCRIPTION	FINISH	QTY
PREMIUM				
Chrome (CH)				
YG0312CH	210.00	12" Designer Grab Bar	Chrome	6
YG0318CH	219.45	18" Designer Grab Bar	Chrome	6
YG0324CH	229.30	24" Designer Grab Bar	Chrome	6
YG0336CH	261.00	36" Designer Grab Bar	Chrome	6
YG0342CH	384.05	42" Designer Grab Bar	Chrome	6
Brushed Nickel (BN)				
YG0312BN	272.95	12" Designer Grab Bar	Brushed Nickel	6
YG0318BN	285.25	18" Designer Grab Bar	Brushed Nickel	6
YG0324BN	297.95	24" Designer Grab Bar	Brushed Nickel	6
YG0336BN	339.30	36" Designer Grab Bar	Brushed Nickel	6
YG0342BN	499.25	42" Designer Grab Bar	Brushed Nickel	6
Brushed Gold (BG)				
YG0312BG	327.60	12" Designer Grab Bar	Brushed Gold	6
YG0318BG	342.25	18" Designer Grab Bar	Brushed Gold	6
YG0324BG	357.60	24" Designer Grab Bar	Brushed Gold	6
YG0336BG	407.15	36" Designer Grab Bar	Brushed Gold	6
YG0342BG	599.15	42" Designer Grab Bar	Brushed Gold	6
Polished Nickel (NL)				
YG0312NL	300.25	12" Designer Grab Bar	Polished Nickel	6
YG0318NL	313.80	18" Designer Grab Bar	Polished Nickel	6
YG0324NL	327.85	24" Designer Grab Bar	Polished Nickel	6
YG0336NL	373.20	36" Designer Grab Bar	Polished Nickel	6
YG0342NL	549.20	42" Designer Grab Bar	Polished Nickel	6



24" Designer Grab Bar
YG0324 |

90° GRAB BARS - 1 1/4" DIAMETER CONCEALED SCREW

MODEL	LIST PRICE	DESCRIPTION	FINISH	QTY
PREMIUM				
Chrome (CH)				
YG8812CH	192.55	12" Designer Grab Bar	Chrome	6
YG8818CH	201.20	18" Designer Grab Bar	Chrome	6
YG8824CH	210.20	24" Designer Grab Bar	Chrome	6
YG8836CH	239.25	36" Designer Grab Bar	Chrome	6
YG8842CH	352.20	42" Designer Grab Bar	Chrome	6
Brushed Nickel (BN)				
YG8812BN	208.10	12" Designer Grab Bar	Brushed Nickel	6
YG8818BN	218.10	18" Designer Grab Bar	Brushed Nickel	6
YG8824BN	235.40	24" Designer Grab Bar	Brushed Nickel	6
YG8836BN	265.05	36" Designer Grab Bar	Brushed Nickel	6
YG8842BN	389.35	42" Designer Grab Bar	Brushed Nickel	6
Matte Black (BL)				
YG8812BL	226.85	12" Designer Grab Bar	Matte Black	6 NEW! Q3
YG8818BL	237.75	18" Designer Grab Bar	Matte Black	6 NEW! Q3
YG8824BL	256.55	24" Designer Grab Bar	Matte Black	6 NEW! Q3
YG8836BL	288.90	36" Designer Grab Bar	Matte Black	6 NEW! Q3
YG8842BL	424.40	42" Designer Grab Bar	Matte Black	6 NEW! Q3



24" Designer Grab Bar
YG8824 |

ADA-Compliant

SecureMount™ for non-stud installation sold separately. See page 519 for details.
List price is per each (unless otherwise noted). Product can be ordered by case quantity or individually.

Grab Bars

ALIGN® GRAB BARS - 1 1/4" DIAMETER CONCEALED SCREW

MODEL	LIST PRICE	DESCRIPTION	FINISH	QTY
Chrome (CH)				
YG0412CH	128.75	12" Designer Grab Bar	Chrome	6
YG0418CH	134.50	18" Designer Grab Bar	Chrome	6
YG0424CH	140.50	24" Designer Grab Bar	Chrome	6
YG0436CH	159.95	36" Designer Grab Bar	Chrome	6
YG0442CH	234.70	42" Designer Grab Bar	Chrome	6

Brushed Nickel (BN)

YG0412BN	155.65	12" Designer Grab Bar	Brushed Nickel	6
YG0418BN	163.15	18" Designer Grab Bar	Brushed Nickel	6
YG0424BN	176.05	24" Designer Grab Bar	Brushed Nickel	6
YG0436BN	198.15	36" Designer Grab Bar	Brushed Nickel	6
YG0442BN	293.40	42" Designer Grab Bar	Brushed Nickel	6

Brushed Gold (BG)

YG0418BG	195.75	18" Designer Grab Bar	Brushed Gold	6
YG0424BG	211.20	24" Designer Grab Bar	Brushed Gold	6

VOSS™ GRAB BARS - 1 1/4" DIAMETER CONCEALED SCREW

MODEL	LIST PRICE	DESCRIPTION	FINISH	QTY
Chrome (CH)				
YG5112CH	123.55	12" Designer Grab Bar	Chrome	6
YG5118CH	129.10	18" Designer Grab Bar	Chrome	6
YG5124CH	134.90	24" Designer Grab Bar	Chrome	6

Brushed Nickel (BN)

YG5112BN	149.35	12" Designer Grab Bar	Brushed Nickel	6
YG5118BN	156.60	18" Designer Grab Bar	Brushed Nickel	6
YG5124BN	168.95	24" Designer Grab Bar	Brushed Nickel	6

Brushed Gold (BG)

YG5112BG	179.15	12" Designer Grab Bar	Brushed Gold	6
YG5118BG	187.85	18" Designer Grab Bar	Brushed Gold	6
YG5124BG	202.65	24" Designer Grab Bar	Brushed Gold	6

Polished Nickel (NL)

YG5112NL	166.60	12" Designer Grab Bar	Polished Nickel	6
YG5118NL	180.50	18" Designer Grab Bar	Polished Nickel	6
YG5124NL	202.00	24" Designer Grab Bar	Polished Nickel	6

Oil Rubbed Bronze (ORB)

YG5112ORB	164.20	12" Designer Grab Bar	Oil Rubbed Bronze	6
YG5118ORB	172.30	18" Designer Grab Bar	Oil Rubbed Bronze	6
YG5124ORB	185.90	24" Designer Grab Bar	Oil Rubbed Bronze	6

Matte Black (BL)

YG5112BL	164.20	12" Designer Grab Bar	Matte Black	6	NEW! Q3
YG5118BL	172.30	18" Designer Grab Bar	Matte Black	6	NEW! Q3
YG5124BL	185.90	24" Designer Grab Bar	Matte Black	6	NEW! Q3

**24" Designer Grab Bar**

YG0424 |

**24" Designer Grab Bar**

YG5124 |



SecureMount™ for non-stud installation sold separately. See page 519 for details.
List price is per each (unless otherwise noted). Product can be ordered by case quantity or individually.

BELFIELD™ GRAB BARS - 1 ¼" DIAMETER CONCEALED SCREW

MODEL	LIST PRICE	DESCRIPTION	FINISH	QTY
Chrome (CH)				
YG6412CH	124.10	12" Designer Grab Bar	Chrome	6
YG6418CH	129.65	18" Designer Grab Bar	Chrome	6
YG6424CH	135.40	24" Designer Grab Bar	Chrome	6
Brushed Nickel (BN)				
YG6412BN	149.90	12" Designer Grab Bar	Brushed Nickel	6
YG6418BN	157.20	18" Designer Grab Bar	Brushed Nickel	6
YG6424BN	169.55	24" Designer Grab Bar	Brushed Nickel	6
Polished Nickel (NL)				
YG6412NL	149.90	12" Designer Grab Bar	Polished Nickel	6
YG6418NL	156.65	18" Designer Grab Bar	Polished Nickel	6
YG6424NL	163.60	24" Designer Grab Bar	Polished Nickel	6
Oil Rubbed Bronze (ORB)				
YG6412ORB	164.95	12" Designer Grab Bar	Oil Rubbed Bronze	6
YG6418ORB	172.90	18" Designer Grab Bar	Oil Rubbed Bronze	6
YG6424ORB	186.60	24" Designer Grab Bar	Oil Rubbed Bronze	6
Matte Black (BL)				
YG6412BL	149.90	12" Designer Grab Bar	Matte Black	6
YG6418BL	156.65	18" Designer Grab Bar	Matte Black	6
YG6424BL	163.60	24" Designer Grab Bar	Matte Black	6

**24" Designer Grab Bar**YG6424 | **KINGSLEY® GRAB BARS - 1 ¼" DIAMETER CONCEALED SCREW**

MODEL	LIST PRICE	DESCRIPTION	FINISH	QTY
Chrome (CH)				
YG5412CH	134.35	12" Designer Grab Bar	Chrome	3
YG5418CH	140.40	18" Designer Grab Bar	Chrome	3
YG5424CH	146.60	24" Designer Grab Bar	Chrome	3
YG5430CH	156.85	30" Designer Grab Bar	Chrome	3
YG5436CH	166.90	36" Designer Grab Bar	Chrome	3
YG5442CH	244.95	42" Designer Grab Bar	Chrome	3
Brushed Nickel (BN)				
YG5412BN	162.45	12" Designer Grab Bar	Brushed Nickel	3
YG5418BN	170.20	18" Designer Grab Bar	Brushed Nickel	3
YG5424BN	183.75	24" Designer Grab Bar	Brushed Nickel	3
YG5430BN	191.40	30" Designer Grab Bar	Brushed Nickel	3
YG5436BN	206.75	36" Designer Grab Bar	Brushed Nickel	3
YG5442BN	306.25	42" Designer Grab Bar	Brushed Nickel	3
Oil Rubbed Bronze (ORB)				
YG5412ORB	178.65	12" Designer Grab Bar	Oil Rubbed Bronze	3
YG5418ORB	187.45	18" Designer Grab Bar	Oil Rubbed Bronze	3
YG5424ORB	202.25	24" Designer Grab Bar	Oil Rubbed Bronze	3

**24" Designer Grab Bar**YG5424 |  ADA-CompliantSecureMount™ for non-stud installation sold separately. See page 519 for details.
List price is per each (unless otherwise noted). Product can be ordered by case quantity or individually.

Grab Bars

BRANTFORD® GRAB BARS - 1 1/4" DIAMETER CONCEALED SCREW

MODEL	LIST PRICE	DESCRIPTION	FINISH	QTY
Chrome (CH)				
YG2212CH	109.65	12" Designer Grab Bar	Chrome	6
YG2218CH	115.90	18" Designer Grab Bar	Chrome	6
YG2224CH	121.40	24" Designer Grab Bar	Chrome	6
Brushed Nickel (BN)				
YG2212BN	133.75	12" Designer Grab Bar	Brushed Nickel	6
YG2218BN	140.50	18" Designer Grab Bar	Brushed Nickel	6
YG2224BN	152.05	24" Designer Grab Bar	Brushed Nickel	6
Oil Rubbed Bronze (ORB)				
YG2212ORB	146.25	12" Designer Grab Bar	Oil Rubbed Bronze	6
YG2218ORB	153.70	18" Designer Grab Bar	Oil Rubbed Bronze	6
YG2224ORB	169.65	24" Designer Grab Bar	Oil Rubbed Bronze	6

EVA® GRAB BARS - 1 1/4" DIAMETER CONCEALED SCREW

MODEL	LIST PRICE	DESCRIPTION	FINISH	QTY
Chrome (CH)				
YG2812CH	109.65	12" Designer Grab Bar	Chrome	6
YG2818CH	115.90	18" Designer Grab Bar	Chrome	6
YG2824CH	121.40	24" Designer Grab Bar	Chrome	6
Brushed Nickel (BN)				
YG2812BN	133.75	12" Designer Grab Bar	Brushed Nickel	6
YG2818BN	140.50	18" Designer Grab Bar	Brushed Nickel	6
YG2824BN	152.05	24" Designer Grab Bar	Brushed Nickel	6
Oil Rubbed Bronze (ORB)				
YG2812ORB	146.25	12" Designer Grab Bar	Oil Rubbed Bronze	6
YG2818ORB	153.70	18" Designer Grab Bar	Oil Rubbed Bronze	6
YG2824ORB	169.65	24" Designer Grab Bar	Oil Rubbed Bronze	6

**24" Designer Grab Bar**

YG2224 |

**24" Designer Grab Bar**

YG2824 |

ISO™ GRAB BARS - 1 1/4" DIAMETER CONCEALED SCREW

MODEL	LIST PRICE	DESCRIPTION	FINISH	QTY
Chrome (CH)				
YG0712CH	84.45	12" Designer Grab Bar	Chrome	6
YG0718CH	89.05	18" Designer Grab Bar	Chrome	6
YG0724CH	93.65	24" Designer Grab Bar	Chrome	6
YG0736CH	106.65	36" Designer Grab Bar	Chrome	6
YG0742CH	156.75	42" Designer Grab Bar	Chrome	6
Brushed Nickel (BN)				
YG0712BN	94.75	12" Designer Grab Bar	Brushed Nickel	6
YG0718BN	99.75	18" Designer Grab Bar	Brushed Nickel	6
YG0724BN	104.80	24" Designer Grab Bar	Brushed Nickel	6
YG0736BN	119.40	36" Designer Grab Bar	Brushed Nickel	6
YG0742BN	176.75	42" Designer Grab Bar	Brushed Nickel	6
Matte Black (BL)				
YG0712BL	102.05	12" Designer Grab Bar	Matte Black	6
YG0718BL	107.70	18" Designer Grab Bar	Matte Black	6
YG0724BL	113.20	24" Designer Grab Bar	Matte Black	6
YG0736BL	128.90	36" Designer Grab Bar	Matte Black	6
YG0742BL	189.40	42" Designer Grab Bar	Matte Black	6

**18" Designer Grab Bar**YG0718 | **GENTA™ LX GRAB BARS - 1 1/4" DIAMETER CONCEALED SCREW**

MODEL	LIST PRICE	DESCRIPTION	FINISH	QTY
Chrome (CH)				
MBHG3818CH	141.40	18" Designer Grab Bar	Chrome	3
Brushed Nickel (BN)				
MBHG3818BN	147.15	18" Designer Grab Bar	Brushed Nickel	3

**18" Designer Grab Bar**MBHG3818CH | 

Grab Bars

DESIGNER ELEGANCE WITH GRIP PADS - 1 1/4" DIAMETER CONCEALED SCREW

MODEL	LIST PRICE	DESCRIPTION	FINISH	QTY
Chrome (CH)				
R8716D1GCH	64.40	16" Designer Grab Bar	Chrome	3
LR8724D1GCH▲	69.65	24" Designer Grab Bar	Chrome	3
Brushed Nickel (BN)				
R8716D1GBN	69.65	16" Designer Grab Bar	Brushed Nickel	3
LR8724D1GBN▲	73.05	24" Designer Grab Bar	Brushed Nickel	3
RA8716D1GBN	79.60	16" Designer Grab Bar - ANGLED	Brushed Nickel	3
Old World Bronze (OWB)				
LR8724D1GOWB▲	86.85	24" Designer Grab Bar	Old World Bronze	3



Designer Elegance Grab Bar with Grip Pads
R8716D1G |



Designer Elegance Angled Grab Bar with Grip Pads
RA8716D1G |

DESIGNER ULTIMA - 1 1/4" DIAMETER CONCEALED SCREW

MODEL	LIST PRICE	DESCRIPTION	FINISH	QTY
Chrome (CH)				
LR8716D3CH▲	39.90	16" Designer Grab Bar	Chrome	3
LR8724D3CH▲	46.95	24" Designer Grab Bar	Chrome	3
Brushed Nickel (BN)				
LR8716D3BN▲	44.75	16" Designer Grab Bar	Brushed Nickel	3
LR8724D3BN▲	52.15	24" Designer Grab Bar	Brushed Nickel	3



Designer Ultima Grab Bar
LR8716D3 |

DESIGNER ELITE - 1 1/4" DIAMETER CONCEALED SCREW

MODEL	LIST PRICE	DESCRIPTION	FINISH	QTY
Chrome (CH)				
LR8724D2CH▲	46.90	24" Designer Grab Bar	Chrome	3
Brushed Nickel (BN)				
LR8724D2BN▲	52.20	24" Designer Grab Bar	Brushed Nickel	3



Designer Elite Grab Bar
LR8724D2 |

COORDINATING ACCESSORIES

▲ Retail Packaging

ADA-Compliant

SecureMount™ for non-stud installation sold separately. See page 519 for details.
List price is per each (unless otherwise noted). Product can be ordered by case quantity or individually.

DESIGNER ULTIMA WITH CURL GRIP - 1 1/4" DIAMETER CONCEALED SCREW

MODEL	LIST PRICE	DESCRIPTION	FINISH	QTY
Chrome (CH)				
R8712D3GCH	57.25	12" Designer Grab Bar	Chrome	6
LR8716D3GCH▲	63.00	16" Designer Grab Bar	Chrome	3
R8718D3GCH	62.75	18" Designer Grab Bar	Chrome	6
LR8724D3GCH▲	69.00	24" Designer Grab Bar	Chrome	3
R8736D3GCH	104.55	36" Designer Grab Bar	Chrome	6
R8742D3GCH	126.70	42" Designer Grab Bar	Chrome	6
R8748D3GCH	144.40	48" Designer Grab Bar	Chrome	6
Brushed Nickel (BN)				
R8712D3GBN	62.70	12" Designer Grab Bar	Brushed Nickel	6
LR8716D3GBN▲	64.40	16" Designer Grab Bar	Brushed Nickel	3
R8718D3GBN	71.25	18" Designer Grab Bar	Brushed Nickel	6
LR8724D3GBN▲	75.20	24" Designer Grab Bar	Brushed Nickel	3
R8736D3GBN	105.55	36" Designer Grab Bar	Brushed Nickel	6
R8742D3GBN	127.95	42" Designer Grab Bar	Brushed Nickel	6
R8748D3GBN	146.55	48" Designer Grab Bar	Brushed Nickel	6
Old World Bronze (OWB)				
R8712D3GOWB	75.20	12" Designer Grab Bar	Old World Bronze	6
LR8716D3GOWB▲	76.20	16" Designer Grab Bar	Old World Bronze	3
R8718D3GOWB	83.95	18" Designer Grab Bar	Old World Bronze	6
LR8724D3GOWB▲	89.10	24" Designer Grab Bar	Old World Bronze	3
R8736D3GOWB	124.85	36" Designer Grab Bar	Old World Bronze	6
R8742D3GOWB	149.95	42" Designer Grab Bar	Old World Bronze	6
R8748D3GOWB	170.85	48" Designer Grab Bar	Old World Bronze	6



**Designer
Ultima Grab Bar
with Curl Grips**
R8718D3G | 

**COORDINATING
ACCESSORIES**

▲ Retail Packaging

 ADA-Compliant

SecureMount™ for non-stud installation sold separately. See page 519 for details.

List price is per each (unless otherwise noted). Product can be ordered by case quantity or individually.

Grab Bars

1 1/4" DIAMETER CONCEALED SCREW

MODEL	LIST PRICE	DESCRIPTION	FINISH	QTY
Stainless (SS)				
DN8712	29.60	12" Grab Bar	Stainless	6
8716	33.00	16" Grab Bar	Stainless	6
8718	34.20	18" Grab Bar	Stainless	6
8724	35.35	24" Grab Bar	Stainless	6
8730	39.90	30" Grab Bar	Stainless	6
8732	41.95	32" Grab Bar	Stainless	6
8736	46.70	36" Grab Bar	Stainless	6
8742	50.55	42" Grab Bar	Stainless	6
8748	55.55	48" Grab Bar	Stainless	6
Polished Stainless (PS)				
R8718PS	42.45	18" Grab Bar	Polished Stainless	6
LR8724PS	50.85	24" Grab Bar	Polished Stainless	3
R8724PS	46.50	24" Grab Bar	Polished Stainless	6
R8736PS	54.85	36" Grab Bar	Polished Stainless	6
R8742PS	67.10	42" Grab Bar	Polished Stainless	6
Polished Brass (PB)				
R8718PB	83.40	18" Grab Bar	Polished Brass	6
R8724PB	99.70	24" Grab Bar	Polished Brass	6
Glacier (W)				
R8712W	39.10	12" Grab Bar	Glacier	6
R8716W	45.05	16" Grab Bar	Glacier	6
R8718W	47.25	18" Grab Bar	Glacier	6
R8724W	51.30	24" Grab Bar	Glacier	6
R8730W	56.45	30" Grab Bar	Glacier	6
R8732W	58.15	32" Grab Bar	Glacier	6
R8736W	62.95	36" Grab Bar	Glacier	6
R8742W	69.30	42" Grab Bar	Glacier	6
R8748W	70.75	48" Grab Bar	Glacier	6
Peened (P)				
R8712P	27.95	12" Grab Bar	Peened	6
R8716P	31.20	16" Grab Bar	Peened	6
R8718P	32.95	18" Grab Bar	Peened	6
R8724P	37.55	24" Grab Bar	Peened	6
R8730P	44.45	30" Grab Bar	Peened	6
R8732P	42.45	32" Grab Bar	Peened	6
R8736P	50.35	36" Grab Bar	Peened	6
R8742P	54.10	42" Grab Bar	Peened	6
R8748P	63.95	48" Grab Bar	Peened	6



**1 1/4" Diameter
Concealed Screw
Grab Bar**
8716 | 



**1 1/4" Diameter
Concealed Screw
Peened Grab Bar**
R8724P | 

COORDINATING ACCESSORIES

1 1/2" DIAMETER CONCEALED SCREW

MODEL	LIST PRICE	DESCRIPTION	FINISH	QTY
Stainless (SS)				
R8912	31.60	12" Grab Bar	Stainless	6
R8916	34.15	16" Grab Bar	Stainless	6
R8918	37.55	18" Grab Bar	Stainless	6
R8924	42.45	24" Grab Bar	Stainless	6
R8930	45.75	30" Grab Bar	Stainless	6
R8932	49.35	32" Grab Bar	Stainless	6
R8936	52.05	36" Grab Bar	Stainless	6
R8942	56.95	42" Grab Bar	Stainless	6
DN8948	64.50	48" Grab Bar	Stainless	6
Glacier (W)				
R8912W	48.75	12" Grab Bar	Glacier	6
R8918W	59.85	18" Grab Bar	Glacier	6
R8924W	64.85	24" Grab Bar	Glacier	6
R8930W	70.05	30" Grab Bar	Glacier	6
R8932W	75.65	32" Grab Bar	Glacier	6
R8936W	79.95	36" Grab Bar	Glacier	6
R8942W	86.30	42" Grab Bar	Glacier	6
R8948W	88.95	48" Grab Bar	Glacier	6
Peened (P)				
R8912P	32.50	12" Grab Bar	Peened	6
R8916P	32.95	16" Grab Bar	Peened	6
R8918P	39.20	18" Grab Bar	Peened	6
R8924P	44.45	24" Grab Bar	Peened	6
R8930P	48.15	30" Grab Bar	Peened	6
R8932P	52.05	32" Grab Bar	Peened	6
R8936P	55.30	36" Grab Bar	Peened	6
R8942P	59.55	42" Grab Bar	Peened	6
R8948P	61.35	48" Grab Bar	Peened	6
8992	110.40	16" x 32" L-shaped Grab Bar	Peened	3
8994	111.25	24" x 36" L-shaped Grab Bar	Peened	3
8996	118.65	24" x 48" L-shaped Grab Bar	Peened	3



1 1/2" Diameter Concealed Screw Grab Bar
R8916 |



1 1/2" Diameter Concealed Screw Grab Bar - Peened
R8916P |



1 1/2" Diameter Concealed Screw Grab Bar - Glacier
R8918W |



24" x 36" L-Shaped Grab Bar - Peened
8994 |

ADA-Compliant

SecureMount™ for non-stud installation sold separately. See page 519 for details.
List price is per each (unless otherwise noted). Product can be ordered by case quantity or individually.

Grab Bars

1 1/4" DIAMETER EXPOSED SCREW

MODEL	LIST PRICE	DESCRIPTION	FINISH	QTY
Stainless (SS)				
7412	24.20	12" Grab Bar	Stainless	6
R7418	22.25	18" Grab Bar	Stainless	6
R7424	25.30	24" Grab Bar	Stainless	6
R7436	35.25	36" Grab Bar	Stainless	6
R7442	38.15	42" Grab Bar	Stainless	6



1 1/4" Diameter Exposed Screw Grab Bar - Stainless
7412 |

1 1/2" DIAMETER EXPOSED SCREW

MODEL	LIST PRICE	DESCRIPTION	FINISH	QTY
Stainless (SS)				
LR7518▲	29.60	18" Grab Bar	Stainless	3
LR7524▲	33.75	24" Grab Bar	Stainless	3
LR7536▲	42.65	36" Grab Bar	Stainless	3
LR7542▲	47.45	42" Grab Bar	Stainless	3



1 1/2" Diameter Exposed Screw Grab Bar - Stainless
LR7518 |

FLIP UP GRAB BARS

MODEL	LIST PRICE	DESCRIPTION	FINISH	QTY
Peened (FD)				
R8960FD	177.35	30" Flip Up Grab Bar	Peened	2
R8962FD	202.95	30" Flip Up Grab Bar with Paper Holder	Peened	2
Glacier (W)				
R8960FDW	173.90	30" Flip Up Grab Bar	Glacier	2
R8962FDW	192.70	30" Flip Up Grab Bar with Paper Holder	Glacier	2



Flip-Up Grab Bar
R8960FD |

COORDINATING ACCESSORIES

▲ Retail Packaging

ADA-Compliant

SecureMount™ for non-stud installation sold separately. See page 519 for details.
List price is per each (unless otherwise noted). Product can be ordered by case quantity or individually.

COORDINATING ACCESSORIES

GRAB BARS WITH ACCESSORIES

MODEL	LIST PRICE	DESCRIPTION	FINISH	QTY
Chrome (CH)				
LR2350DCH▲	71.95	24" Grab Bar With Towel Bar	Chrome	3
LR2352DCH▲	71.95	8" Grab Bar With Paper Holder	Chrome	3
LR2354DCH▲	71.95	9" Grab Bar With Corner Shelf	Chrome	3
LR2356DCH▲	71.95	16" Grab Bar With Shelf	Chrome	3
Brushed Nickel (BN)				
LR2350DBN	74.80	24" Grab Bar With Towel Bar	Brushed Nickel	3
LR2352DBN	69.20	8" Grab Bar With Paper Holder	Brushed Nickel	3
LR2354DBN	74.80	9" Grab Bar With Corner Shelf	Brushed Nickel	3
R2356DBN	77.05	16" Grab Bar With Shelf	Brushed Nickel	3



24" Grab Bar with Towel Bar
LR2350D | ♿



8" Grab Bar with Paper Holder
LR2352D | ♿



9" Grab Bar with Corner Shelf
LR2354D | ♿



16" Grab Bar with Shelf
LR2356D/R2356D | ♿

SECUREMOUNT™ ANCHORS

MODEL	LIST PRICE	DESCRIPTION	FINISH	QTY
Chrome (CH)				
SMA1000CH	39.35	SecureMount™ Anchors and Plate - One Pair	Chrome	24
SMA1001CH	37.70	SecureMount™ Anchors and Plates - 10 Pairs	Chrome	10
Old World Bronze (OWB)				
SMA1000OWB	42.50	SecureMount™ Anchor and Plate - 1 Pair	Old World Bronze	24



SecureMount™ - One Pair
SMA1000CH



SecureMount™ - ProPak of 10 Pairs
SMA1001

HAND GRIPS WITH EXPOSED SCREW

MODEL	LIST PRICE	DESCRIPTION	FINISH	QTY
Chrome (CH)				
LR2250DCH▲	26.70	9" Designer Hand Grip	Chrome	3
R2250	18.80	9" Hand Grip	Chrome	6
R2260	22.65	16" Hand Grip	Chrome	6
R2270	26.85	24" Hand Grip	Chrome	6



Designer Hand Grip
LR2250DCH



Hand Grip
R2250

▲ Retail Packaging

♿ ADA-Compliant

SecureMount™ for non-stud installation sold separately. See page 519 for details.
List price is per each (unless otherwise noted). Product can be ordered by case quantity or individually.

Bath Safety

TUB/SHOWER CHAIRS, SEATS, TRANSFER BENCHES				
MODEL	LIST PRICE	DESCRIPTION	FINISH	QTY
DN7110	477.65	Fold-Down Teak Shower Seat	Wood/Stainless Steel	2
DN71100WB	554.15	Fold-Down Teak Shower Seat	Wood/Old World Bronze	2
DN7060▲	102.00	Adjustable Tool-Free Tub and Shower Chair	Glacier	2
DN7025▲	61.20	Adjustable Tub and Shower Seat	Glacier	2
DN7030▲	78.00	Adjustable Shower Chair	Glacier	2
DN7100▲	137.30	Mesh Shower Chair	Glacier	2
DN7105▲	176.55	Transfer Bench	Glacier	2

COORDINATING ACCESSORIES



Teak Shower Seat*
DN7110 | ♿



Adjustable Tub and Shower Chair
DN7060 | ♿



Adjustable Tub and Shower Seat
DN7025 | ♿



Adjustable Shower Chair
DN7030 | ♿



Mesh Shower Chair
DN7100 | ♿



Transfer Bench
DN7105 | ♿

*The natural properties of Teak allow for the wood to weather over time in the environment. If you desire to keep the current look of the wood, treat the teak with a certified Teak oil.

▲ Retail Packaging

♿ ADA-Compliant

SecureMount™ for non-stud installation sold separately. See page 519 for details. List price is per each (unless otherwise noted). Product can be ordered by case quantity or individually.

COORDINATING ACCESSORIES

TUB/SHOWER CHAIRS, SEATS, TRANSFER BENCHES				
MODEL	LIST PRICE	DESCRIPTION	FINISH	QTY
DN7020▲	42.70	Elevated Toilet Seat	Glacier	2
DN7015▲	45.05	Toilet Safety Rails	Glacier	2
DN7175▲	72.15	SecureLock™ Tub Grip	Glacier	2
DN7075▲	102.30	Locking Dual Tub Grip	Glacier	2
DN7005▲	46.10	Multi-Grip Tub Safety Bar	Glacier	2
DN7010▲	37.30	Low-Profile Tub Safety Bar	Glacier	2
DN7050▲	19.45	Bath Mat	Glacier	24



Elevated Toilet Seat
DN7020 |



Toilet Safety Rails
DN7015 |



Tub Grip
DN7175 |



Tub Grip
DN7075 |



Tub Safety Bar
DN7005 |



Tub Safety Bar
DN7010 |



Bath Mat
DN7050

HANDHELD SHOWERS				
MODEL	LIST PRICE	DESCRIPTION	FINISH	QTY
DN8001CH▲	63.45	Pause Control Handheld Shower	Chrome	3
DN8001W▲	57.25	Pause Control Handheld Shower	Glacier	3



Handheld Shower
DN8001CH |



Handheld Shower
DN8001W |

▲ Retail Packaging

ADA-Compliant

SecureMount™ for non-stud installation sold separately. See page 519 for details.
List price is per each (unless otherwise noted). Product can be ordered by case quantity or individually.

PRICE BAND IDENTIFICATION

Matching Accessories

PREMIUM / BEST

- Weymouth** – Traditional
- Arris** – Modern
- Flara** – Transitional
- Colinet** – Traditional
- 90°** – Modern
- Doux** – Modern

2ND UPGRADE / BETTER

- Wynford** – Traditional
- Align** – Modern
- Belfield** – Traditional
- Voss** – Transitional

1ST UPGRADE / GOOD

- Dartmoor** – Traditional
- Glyde** – Transitional
- Brantford** – Traditional
- Eva** – Transitional
- Genta** – Modern

Coordinating Accessories

1ST UPGRADE / GOOD

- Arlys** – Modern
- Triva** – Modern

CORE

- Retreat** – Traditional
- Sage** – Transitional
- Iso** – Modern
- Kyvos** – Modern
- Lounge** – Transitional
- Madison** – Traditional
- Preston** – Traditional
- Madison** – Traditional
- Aspen** – Modern
- Kingsley** – Traditional

Mirror Only

- Gilcrest** – Traditional
- Glenshire** – Traditional

SPEC

- Mason** – Transitional

COORDINATING ACCESSORIES



Moen® Genuine Replacement Parts



Please see [moen.com/customer-support/warranty](https://www.moen.com/customer-support/warranty) for complete product warranty information.

All Brushed Nickel, Brushed Gold and Polished Brass faucet components feature the LifeShine® Non-Tarnish Finish.

Single-Family Repair and Replace Toolbox

Moen® products are built to last. The real-world testing that goes into all Moen products ensures they are built for the most demanding environments, where heavy use and abuse must be met with exceptional durability and performance. But if they do need repair, we've made that fast and easy as well with stocked toolboxes (#28974), filled with the most commonly used Moen repair and replacement parts. That's over \$600 worth of product for when you need it most.

Please reach out to your Moen rep to purchase this exclusive toolbox. This toolbox is not part of a replenishment program. Purchase of this toolbox is a one-time purchase and not eligible for no-charge parts replenishment on-going.



Toolbox pictured above.
Parts may vary. SKU# 28974

Moen Plumber Connection

Your online toolbox for all things Moen. This site is built for professional plumbers and plumbing business owners of all skill levels to advance knowledge and support you in the field with on-the-job resources.



BUILDING SKILLS

Build your skills and knowledge with online training that's accessible 24/7.



LEARN AND EARN

Earn points to redeem rewards which include gear from brands like YETI®, Carhartt® and more.



TOOLS AND RESOURCES









Extensive lineup of product literature, parts guides, how-to video and more all in one location.

Scan the QR code below or visit moen.com/plumber to register and take advantage of these valuable resources and on-the-job support.



MOEN® | PLUMBER
CONNECTION

Merchandising Solutions

		MODEL	LIST	FINISH/CONNECT	CASE QTY
CARDED PARTS - SHOWERING					
	<ul style="list-style-type: none"> • 6" shower arm and flange • connection size: 1/2" • connection type: IPS 	CL10154	36.80	Chrome	12
		CL10154BN	74.35	Brushed Nickel	12
	<ul style="list-style-type: none"> • 8" shower arm and flange • connection size: 1/2" • connection type: IPS 	CL123815	46.05	Chrome	12
		CL123815BN	86.90	Brushed Nickel	12
	<ul style="list-style-type: none"> • handshower wall bracket • integral handshower cradle: included • pivots to adjust angle of handshower 	CL155694	30.35	Chrome	12
		CL155694BN	43.85	Brushed Nickel	12
	<ul style="list-style-type: none"> • handshower hose • connection size: 1/2" • connection type: IPS • hose length: 59" • metal construction: yes 	CL155748	46.90	Chrome	12
		CL155748BN	68.05	Brushed Nickel	12
	<ul style="list-style-type: none"> • replacement handshower • showerhead functions: one-function • showerhead type: eco-performance handshower • showerhead size: 4" diameter spray head • type of function: full spray • double check valve: included 	CL155747	78.55	Chrome	6
		CL155747BN	113.90	Brushed Nickel	6
	<ul style="list-style-type: none"> • replacement handshower • showerhead functions: four-function • showerhead type: eco-performance handshower • showerhead size: 4" diameter spray head • type of function: combination; full spray; invigorating spray; targeted massage • double check valve: included 	CL164928	93.80	Chrome	6
		CL164928BN	136.05	Brushed Nickel	6
	<ul style="list-style-type: none"> • showerhead functions: five-function • connection size: 1/2" • connection type: IPS • showerhead type: standard, eco-performance • showerhead size: 4" diameter spray head • type of function: energizing spray; invigorating spray; refreshing spray; relaxing spray; targeted massage 	CL26500	67.60	Chrome	12
		CL26500BN	110.30	Brushed Nickel	12
	<ul style="list-style-type: none"> • showerhead functions: one-function • connection size: 1/2" • connection type: IPS • showerhead type: standard, eco-performance • showerhead size: 4-3/8" diameter spray head • type of function: full spray 	CL6302	114.75	Chrome	12
		CL6302BN	179.10	Brushed Nickel	12
		Flow Rate:	1.75 gpm (6.65 L/min) max		
		CL26500EP	67.60	Chrome	12
		CL26500EPBN	110.30	Brushed Nickel	12
		Flow Rate:	2.5 gpm (9.5 L/min) max		
		CL6302EP	114.75	Chrome	12
		CL6302EPBN	179.10	Brushed Nickel	12

GENUINE PARTS

Merchandising Solutions

		MODEL	LIST	FINISH/CONNECT	CASE QTY
CARDER PARTS - SHOWERING (CONTINUED)					
 <ul style="list-style-type: none"> • showerhead functions: one-function • connection size: 1/2" • connection type: IPS • showerhead type: standard, eco-performance • showerhead size: 3-1/2" diameter spray head • type of function: full spray 		Flow Rate:	2.5 gpm (9.5 L/min) max		
		CL6303	63.45	Chrome	12
		CL6303BN	97.20	Brushed Nickel	12
		Flow Rate:	1.75 gpm (6.65 L/min) max		
		CL6303EP	63.45	Chrome	12
	CL6303EPBN	97.20	Brushed Nickel	12	
 <ul style="list-style-type: none"> • shower arm diverter • connection size: 1/2" • connection type: IPS • type of function: two independent, one shared • metal construction: yes 		CL703	104.95	Chrome	12
		CL703BN	152.10	Brushed Nickel	12
		CL703ORB	167.40	Oil Rubbed Bronze	12
		CL703BL	167.40	Matte Black	12
 <ul style="list-style-type: none"> • shower arm diverter • connection size: 1/2" • connection type: IPS • type of function: two independent, one shared • integral handshower cradle: included • metal construction: yes • pivots to adjust angle of handshower 		CL707	142.50	Chrome	12
		CL707BN	206.55	Brushed Nickel	12
		CL707ORB	227.25	Oil Rubbed Bronze	12
		CL707BL	227.25	Matte Black	12
 <ul style="list-style-type: none"> • shower arm cradle • connection size: 1/2" • connection type: IPS • integral handshower cradle: included • metal construction: yes • pivots to adjust angle of handshower 		CLA701	61.60	Chrome	12
		CLA701BN	89.10	Brushed Nickel	12
CARDER PARTS - MOEN® GENUINE REPLACEMENT CARTRIDGES					
 <ul style="list-style-type: none"> • 1200® cartridge • single-handle replacement cartridge, brass 		1200	52.90	Carded	36
	 <ul style="list-style-type: none"> • 1225® cartridge • single-handle replacement cartridge 		1225	33.35	Carded
 <ul style="list-style-type: none"> • 1224® cartridge • two-handle replacement cartridge (hot or cold) 			1224	17.35	Carded
	 <ul style="list-style-type: none"> • 1215® cartridge • single-handle replacement cartridge for high-flow wallmount tub filler 		1215	110.00	Carded
 <ul style="list-style-type: none"> • 1248® cartridge • two-handle replacement cartridge for high-flow roman tubs (hot or cold) 			1248	17.35	Carded

GENUINE PARTS

Merchandising Solutions

		MODEL	LIST	FINISH/CONNECT	CASE QTY
CARDED PARTS - MOEN GENUINE REPLACEMENT CARTRIDGES (CONTINUED)					
	<ul style="list-style-type: none"> • 1234® cartridge • two-handle Duralast® cartridge for two-handle lavatory and kitchen faucets (hot or cold) 	1234	16.80	Carded	18
	<ul style="list-style-type: none"> • 1258® cartridge • two-handle Duralast® cartridge for two-handle roman tub faucets (hot or cold) 	1258	17.40	Carded	18
	<ul style="list-style-type: none"> • 1222® cartridge • single-handle replacement cartridge, Posi-Temp® 	1222	88.30	Carded	18
	<ul style="list-style-type: none"> • 1255® cartridge • single-handle Duralast® cartridge • includes plastic retaining nut 	1255	34.15	Carded	72
	<ul style="list-style-type: none"> • 1214® cartridge • thermostatic replacement cartridge for M-CORE® 4-Series 	1214	389.00	Carded	12
	<ul style="list-style-type: none"> • 1213® cartridge • single-handle replacement cartridge, M-CORE® 3 Series 	1213	110.00	Carded	12
	<ul style="list-style-type: none"> • 1212® cartridge • single-handle replacement cartridge, M-CORE® 2-Series 	1212	85.00	Carded	12
	<ul style="list-style-type: none"> • cartridge repair kit for 1222® /1222B® Posi-Temp® single-handle tub/shower 	98040	17.90	Carded	18
	<ul style="list-style-type: none"> • retainer clips for 1200® and 1225® single-handle cartridges 	96365	10.10	Carded	36
	<ul style="list-style-type: none"> • cartridge puller for 1200®, 1222® & 1225® single-handle cartridges 	104421	56.45	Carded	36
	<ul style="list-style-type: none"> • spout o-ring kit • order in multiples of 12 	96778 117	10.65 7.10	Carded Bulk (12 pcs)	36 72

Merchandising Solutions











		MODEL	LIST	FINISH/CONNECT	CASE QTY
CARDED PARTS - HANDLES					
	• handle kit with cap for Chateau® single-handle lav with 1225® cartridge	96782	33.05	Carded	18
	• handle kit, Chateau® single-handle tub/shower, clear knob with cap	98039	33.05	Carded	18
	• handle cap, Chateau® single-handle lav and non-pressure-balancing shower	98032	13.00	Carded	18
	• handle kit, Posi-Temp® single-handle tub/shower with cap	100710	24.45	Carded	18
	• handle kit, Chateau® two-handle lav, kitchen, and tub/shower, clear handles with caps, quantity 2	98026	38.35	Carded	12
	• handle caps, Touch Control two-handle lav, kitchen, bar, and tub/shower	101205	12.70	Carded	18
	• handle insert for two-handle Monticello bath faucet	97557	67.50	Carded	36
CARDED PARTS - AERATORS					
	• aerator, 2.2 gpm, male thread	3919	16.60	Chrome (Carded)	18
	• aerator, 2.2 gpm, female thread	3924	16.60	Chrome (Carded)	18
	• aerator, Swing-n-Spray®, 2.2 gpm	20200	57.15	Chrome (Carded)	18

Merchandising Solutions









		MODEL	LIST	FINISH/CONNECT	CASE QTY
MOEN® GENUINE REPLACEMENT CARTRIDGES					
	<ul style="list-style-type: none"> • 1200° cartridge • single-handle replacement cartridge, brass, order in multiples of 12 	1200	52.90	Carded	36
		1200B	52.90	Bulk (12 pcs.)	144
	<ul style="list-style-type: none"> • 1225° cartridge • single-handle replacement cartridge, order in multiples of 12 	1225	33.35	Carded	36
		1225B	33.35	Bulk (12 pcs.)	144
	<ul style="list-style-type: none"> • 1224° cartridge • two-handle replacement cartridge (hot or cold), order in multiples of 12 • two-handle replacement cartridge, for 4997 valve prior to 6/00 	1224	17.35	Carded	36
		1224B	17.35	Bulk (12 pcs.)	144
		14891	21.15	-	60
	<ul style="list-style-type: none"> • 1215° cartridge • single-handle replacement cartridge for high-flow wallmount tub filler 	1215	110.00	Carded	12
	<ul style="list-style-type: none"> • 1248™ cartridge • two-handle replacement cartridge for high-flow roman tubs, order in multiples of 12 	1248	17.35	Carded	18
		1248B	17.35	Bulk (12 pcs.)	144
	<ul style="list-style-type: none"> • 1234° cartridge • two-handle Duralast® cartridge for two-handle lavatory and kitchen faucets (hot or cold) 	1234	16.80	Carded	18
	<ul style="list-style-type: none"> • 1258° cartridge • two-handle Duralast® cartridge for two-handle roman tub faucets (hot or cold) 	1258	17.40	Carded	18
	<ul style="list-style-type: none"> • 1222° cartridge • single-handle replacement cartridge, Posi-Temp®, order in multiples of 6 • repair kit 96988 	1222	88.30	Carded	18
		1222B	88.30	Bulk (6 pcs.)	72
	<ul style="list-style-type: none"> • brass Posi-Temp® cartridge • single-handle replacement cartridge • graphite composite pressure-balancing spool design 	1222HD	107.15	-	18
	<ul style="list-style-type: none"> • 1255° cartridge • single-handle Duralast® cartridge • includes plastic retaining nut 	1255	34.15	Carded	72

GENUINE PARTS



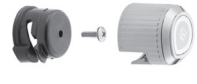



Merchandising Solutions

		MODEL	LIST	FINISH/CONNECT	CASE QTY
MOEN® GENUINE REPLACEMENT CARTRIDGES (CONTINUED)					
	<ul style="list-style-type: none"> • 1214® cartridge • thermostatic replacement cartridge for M-CORE® 4-Series 	1214	389.00	Carded	12
	<ul style="list-style-type: none"> • 1213® cartridge • single-handle replacement cartridge, M-CORE® 3-Series 	1213	110.00	Carded	18
	<ul style="list-style-type: none"> • 1212® cartridge • single-handle replacement cartridge, M-CORE® 2-Series 	1212	85.00	Carded	12
	<ul style="list-style-type: none"> • single-handle Duralast® cartridge • includes plastic retaining nut • brass nut • use with 90° kitchen faucets 	150257	46.95	Bulk	50
CARTRIDGE REPAIR KIT					
	<ul style="list-style-type: none"> • cartridge repair kit for 1222/1222B Posi-Temp® single-handle tub/shower 	98040	17.90	Carded	18
		96988	20.80	-	100
	<ul style="list-style-type: none"> • Moen® silicone oil for Posi-Temp® balancing spools • Moen® silicone grease for cartridges and o-rings • order in multiples of 12 	140676	6.50	-	96
		99915	0.25	-	2500
CARTRIDGE RETAINER CLIPS					
	<ul style="list-style-type: none"> • retainer clips for 1200® and 1225® single-handle cartridges 	96365	10.10	Carded	36
	<ul style="list-style-type: none"> • retainer clips for Posi-Temp® single-handle tub/shower 	96914	6.90	-	500
TOOLS					
	<ul style="list-style-type: none"> • cartridge puller for 1200®, 1222® & 1225® single-handle cartridges 	104421	56.45	Carded	36
	<ul style="list-style-type: none"> • cartridge retainer removal tool for 1224®, 1234®, 1248® & 1258® two-handle cartridge 	14272	7.55	-	150
O-RING KIT					
	<ul style="list-style-type: none"> • spout o-ring kit • order in multiples of 12 	96778	10.65	Carded	36
		117	7.10	Bulk (12 pcs)	72

Merchandising Solutions

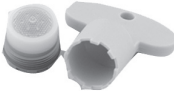
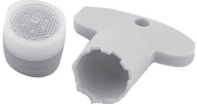
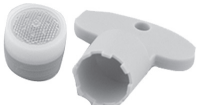
		MODEL	LIST	FINISH/CONNECT	CASE QTY
REPLACEMENT HANDLES AND CAPS					
	• handle kit with cap for Chateau® single handle-lav with 1225 cartridge	96782	33.05	Carded	18
		96791	33.05	-	150
	• handle kit, Chateau® single-handle tub/shower	98039	33.05	Carded	18
	• handle kit, Chateau® single-handle lav with Duralast™	96797	34.25	-	150
	• handle kit with cap for Chateau® single-handle lav with 1234® Duralast™ cartridge	150627	34.25	-	50
	• handle cap kit, Chateau® single-handle lav and non-pressure-balancing shower	98032	13.00	Carded	18
	• handle cap kit, Chateau® single-handle pressure-balanced tub/shower	91751	13.00	-	1,000
	• handle kit, Posi-Temp® single-handle tub/shower with cap	100710	24.45	Carded	18
	• handle kit, less cap, Posi-Temp® single-handle tub/shower	94514	13.50	-	150
	• handle kit, Chateau® two-handle lav, kitchen, and tub/shower, clear handles with caps, quantity 2	98026	38.35	Carded	12
	• lever handle cap, Chateau® single-handle kitchen	96790	34.25	Chrome	250
	• handle caps, Chateau® two-handle lav, kitchen, bar, and tub/shower	13382	12.70	-	300
	• handle caps, Touch Control® two-handle lav, kitchen, bar, and tub/shower	101205	12.70	Carded	18
	• handle insert for two-handle Monticello bath faucet	97557	67.50	Carded	36

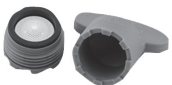

Merchandising Solutions

		MODEL	LIST	FINISH/CONNECT	CASE QTY
ECO-PERFORMANCE AERATOR INSERTS					
	<ul style="list-style-type: none"> • aerator flow restrictor: 1.2 gpm • aerated flow • fits: Flara®, Colinet™, Voss™, Brantford®, Eva®, Belfield™, and Rothbury® 	180158	11.10	-	20
	<ul style="list-style-type: none"> • aerator flow restrictor, 1.5 gpm • aerated flow • fits Chateau®, Castleby®, Villeta®, Eva®, Brantford®, Level™, Monticello®, Kingsley®, Waterhill® and Vestige® lavatory or kitchen faucets 	116711	8.20	-	500
	<ul style="list-style-type: none"> • aerator flow restrictor, 1.0 gpm • aerated flow • fits Chateau®, Castleby®, Villeta®, Eva®, Brantford®, Level™, Monticello®, Kingsley®, Waterhill® and Vestige® lavatory or kitchen faucets 	216721	8.25	-	700
	<ul style="list-style-type: none"> • aerator flow restrictor, 1.5 gpm • laminar flow • for use on all Icon™ and Divine™ lavatory faucets 	316711	8.25	-	350
	<ul style="list-style-type: none"> • aerator flow restrictor, 0.5 gpm • laminar flow • for use on Arris®, Align®, Gibson™ and Icon™ lavatory faucets 	175083	8.25	-	200
	<ul style="list-style-type: none"> • aerator flow restrictor, 1.0 gpm • laminar flow • for use on Arris®, Align® and Icon™ lavatory faucets 	175084	8.25	-	350
	<ul style="list-style-type: none"> • aerator flow restrictor, 1.5 gpm • laminar flow • for use on Felicity™, Savvy™, Organic™, Waterhill® and Tres Chic™ lavatory faucets 	416711	8.25	-	200
	<ul style="list-style-type: none"> • aerator flow restrictor, 0.5 gpm • rosetta spray • fits Chateau®, Castleby®, Villeta®, Eva®, Brantford®, Level™, Monticello®, Kingsley®, and Vestige® lavatory or kitchen faucets 	516711	8.25	-	500
	<ul style="list-style-type: none"> • aerator flow restrictor, 0.5 gpm • vandal proof • fits Chateau® lavs • removal tool included 	52016	22.45	-	24
	<ul style="list-style-type: none"> • aerator flow restrictor, 1.5 gpm • aerated flow • fits Weymouth® lavatory faucets 	154289	8.55	-	20
	<ul style="list-style-type: none"> • aerator Jr., 0.5 gpm • aerated flow • fits Rothbury™ wallmount, Eva®, Brantford™, Danika™, Zarina™ and Method™ single-handle, and Method™ lavatory faucets 	154364	8.25	-	100

GENUINE PARTS

Merchandising Solutions

		MODEL	LIST	FINISH/CONNECT	CASE QTY
ECO-PERFORMANCE AERATOR INSERTS (CONTINUED)					
	<ul style="list-style-type: none"> aerator flow restrictor, 1.0 gpm aerated flow fits Rothbury™ wallmount, Eva®, Brantford®, Danika™ and Zarina™ single-handle, and Method™ lavatory faucets 	163847	12.30	-	100
	<ul style="list-style-type: none"> aerator flow restrictor, 1.5 gpm aerated flow fits Rothbury™ wallmount, Eva® and Brantford® single-handle, and Method™ lavatory faucets 	143326	14.55	-	100
	<ul style="list-style-type: none"> aerator flow restrictor, 0.5 gpm aerated flow fits Rothbury™ single-handle, two-handle and widespreads, and Voss™ lavatory faucets 	165018	8.25	-	12
	<ul style="list-style-type: none"> aerator flow restrictor, 1.5 gpm aerated flow fits Rothbury™ single-handle, two-handle and widespreads, and Voss™ lavatory faucets 	137401	15.70	-	12
	<ul style="list-style-type: none"> aerator flow restrictor, 1.0 gpm aerated flow fits Rothbury™ single-handle, two-handle and widespreads, Rizon®, Glyde™, Dartmoor™ and Voss™ lavatory faucets 	316721	12.30	-	100
AERATORS					
	<ul style="list-style-type: none"> aerator, 2.2 gpm, male thread 	3919	16.60	Chrome (Carded)	18
	<ul style="list-style-type: none"> aerator, 2.2 gpm, female thread 	3924	16.60	Chrome (Carded)	18
SWIVEL-SPRAY AERATORS					
	<ul style="list-style-type: none"> aerator, Swing-n-Spray®, 2.2 gpm 	20200	57.15	Chrome (Carded)	18
PULLOUT/PULLDOWN HOSE MANAGEMENT SYSTEM					
	<ul style="list-style-type: none"> pullout/pulldown hose management system system helps prevent hose and weight from getting caught on under sink obstructions easy to install ships fully assembled sleeve can be cut to accommodate different cabinet sizes compatible with all Moen® kitchen pulldown and pullout single-handle sidemount SKUs (excludes Aberdeen™) 	159060	22.20	Chrome	6











		MODEL	LIST	FINISH/CONNECT	CASE QTY
SIDE SPRAY SERVICE AND ADAPTER KITS					
	<ul style="list-style-type: none"> • side spray plug service kit • plug hose outlet to eliminate quick connect system kitchen side spray 	143530	10.60	-	144
	<ul style="list-style-type: none"> • side spray adapter kit • for faucets with external threads • converts side spray outlet to quick-connect 	168665	32.30	-	50
	<ul style="list-style-type: none"> • side spray adapter kit • for faucets with internal threads • converts side spray outlet to quick-connect 	168666	20.50	-	50









MOEN® AQUASUITE®					
	<ul style="list-style-type: none"> • use with: 77100 series 	9001	110.80	-	6









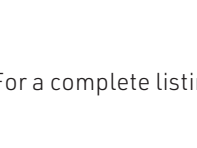

MOEN® CHOICEFLO™ CARBON WATER FILTRATION REPLACEMENT FILTERS					
	<ul style="list-style-type: none"> • use with: PureTouch™ classic series 	601	43.15	-	12

DRAIN PLUG & SEAT					
	<ul style="list-style-type: none"> • lavatory drain plug and threaded seat assembly • non-metallic • works with metal drain body 10790 only 	10709	14.85	Chrome	84
		10709BC	20.75	Brushed Chrome	20
		10709BN	46.35	Brushed Nickel	20
		10709BG	46.35	Brushed Gold	20
		10709NL	50.95	Polished Nickel	20
		10709ORB	51.05	Oil Rubbed Bronze	20
		10709BL	51.05	Matte Black	20
	10709WR	51.05	Wrought Iron	50	
	99596	43.35	Polished Brass	1	













GENUINE PARTS

		MODEL	LIST	FINISH/CONNECT	CASE QTY
EXTENSION KITS					
	<ul style="list-style-type: none"> thick deck extension kit for widespread valve bodies, model 9000/69000 	175709	127.20	-	12
	<ul style="list-style-type: none"> thick deck extension kit for valves with 1/2" threaded mounting shanks 	100818 100817	39.90 37.25	-	20 100
	<ul style="list-style-type: none"> low profile mounting nut fits 1/2" threaded shanks 2 per kit 	145665	5.75	-	120
	<ul style="list-style-type: none"> deck extension kit, single-handle kitchen with quick connect system does not work with current pullout faucets that have hose through mounting shank 	137114	48.15	-	20
	<ul style="list-style-type: none"> 1/2" single-handle shower escutcheon extension fits all single-handle tub/shower with 7" escutcheon 	162	115.10	-	6
M-CORE® TRANSFER VALVE HANDLE EXTENSION KITS					
	<ul style="list-style-type: none"> 1" handle extension kit includes handle extension, set screw and 3/32" hex wrench 	200760	62.90	Chrome	12
M-CORE® HANDLE EXTENSION KITS					
	<ul style="list-style-type: none"> 1" handle extension kits for M-CORE® tub/shower valves round modern for use with Align™, Arris®, Doux®, Colinet®, Flara®, Via®, Greenfield™, Genta™ LX, Gibson™, Vichy®, Eva®, Brantford®, Glyde™, Dartmoor® 	200755	45.25	Chrome	15
		200755BN	73.70	Brushed Nickel	15
		200755BG	73.70	Brushed Gold	15
		200755NL	73.70	Polished Nickel	15
		200755BL	80.90	Matte Black	15
	<ul style="list-style-type: none"> 1" handle extension kits for M-CORE® tub/shower valves round traditional for use with Belfield®, Commercial®, Legend™, Rizon®, Weymouth®, Wynford®, Chateau® 	200779	45.25	Chrome	15
		200779BN	73.70	Brushed Nickel	15
		200779BG	73.70	Brushed Gold	15
		200779NL	73.70	Polished Nickel	15
		200779ORB	81.00	Oil Rubbed Bronze	15
200779BL	81.00	Matte Black	15		
	<ul style="list-style-type: none"> 1" handle extension kits for M-CORE® tub/shower valves square modern for use with 90 Degree® 	200780	45.25	Chrome	15
		200780BN	73.70	Brushed Nickel	15
	<ul style="list-style-type: none"> 1" handle extension kits for M-CORE® tub/shower valves soft square transitional for use with Voss™ 	200781	45.25	Chrome	15
		200781BN	73.70	Brushed Nickel	15
		200781BG	73.70	Brushed Gold	15
		200781NL	73.70	Polished Nickel	15
		200781ORB	81.00	Oil Rubbed Bronze	15











	MODEL	LIST	FINISH/CONNECT	CASE QTY
HANDLE EXTENSION KITS (CONTINUED)				
 <ul style="list-style-type: none"> • 1" handle extension kit, Posi-Temp® single-handle tub/shower 	96945	42.95	Chrome	100
	96945BN	61.45	Brushed Nickel	9
	96945WR	67.55	Wrought Iron*	9
	96945BG	61.45	Brushed Gold	9
	96858	61.35	Polished Brass	1
 <ul style="list-style-type: none"> • 2" handle extension kit, Posi-Temp® single-handle tub/shower • 2" handle extension kit to correct deep rough-in 	96955	52.20	Chrome	1
	96868	75.30	Polished Brass	1
 <ul style="list-style-type: none"> • 1" handle extension kit, Moentrol® single-handle tub/shower <p><i>*Wrought Iron can be used with Oil Rubbed Bronze finish</i></p>	137347	45.25	Chrome	9
	137347NL	53.75	Polished Nickel	9
	137347P	72.15	Polished Brass	9
	137347BN	73.70	Brushed Nickel	9
	137347BG	73.70	Brushed Gold	9
	137347WR	81.00	Wrought Iron*	9
 <ul style="list-style-type: none"> • 1" handle extension kit, Legend® & Chateau® single-handle tub/shower 	10399	42.45	Chrome	36
 <ul style="list-style-type: none"> • roman tub stem extension • adapts to all 3-hole roman tub valves 	106378	22.50	Chrome	250
 <ul style="list-style-type: none"> • body spray extension kit • fits TS1320, TS1322, TS1420 and TS1422 body sprays • 1" extensions 	155656	41.90	-	1
 <ul style="list-style-type: none"> • large volume control escutcheon ring • cover holes up to 2-1/2" diameter • to be used with volume control trim 	129102	42.50	Chrome	12
	129102BN	62.65	Brushed Nickel	12
	129102ORB	68.95	Oil Rubbed Bronze	12
	129102WR	68.95	Wrought Iron	12
	129102NL	62.65	Polished Nickel	12
	129102BG	62.65	Brushed Gold	12
 <ul style="list-style-type: none"> • handle extension kit for ExactTemp® shallow wall installation (thicker ring) • 3/4" extension • to be used with volume control trim 	130153	42.25	Chrome	12
	130153BN	64.85	Brushed Nickel	12
	130153NL	70.80	Polished Nickel	12
	130153ORB	71.30	Oil Rubbed Bronze	12
	130153WR	71.30	Wrought Iron	12
	130153BG	62.55	Brushed Gold	12
ONE HANDLE WALLMOUNT TUB FILLER MANIFOLD				
 <ul style="list-style-type: none"> • Spout manifold for wallmount tub filler • Required for 10" tub filler spout installation 	MANCIS	58.55	-	12
	MANCXS	58.55	-	12
	MANXS	58.55	-	12

		MODEL	LIST	FINISH/CONNECT	CASE QTY
HANDLE EXTENSION KITS (CONTINUED)					
	<ul style="list-style-type: none"> • handle extension kits for models after July 2007 • 1" handle extension kit, 3-function transfer valve • <i>*wrought Iron can be used with Oil Rubbed Bronze</i> 	135167	58.70	Chrome	9
		135167BN	107.05	Brushed Nickel	9
		135167WR	117.95	Wrought Iron*	9
	<ul style="list-style-type: none"> • thread adapter and extension • for S3371 after September 2009; 3/4" extension 	147206	108.05	-	12
	<ul style="list-style-type: none"> • 1" handle control extension kit • for use with volume control trim 	147212	40.60	-	12
	<ul style="list-style-type: none"> • 1" extension kit • for use with transfer valve trim (three-function transfer valve trim kit) 	148479	32.50	Chrome	25
		148479BN	60.80	Brushed Nickel	25
		148479WR	61.20	Wrought Iron*	25
CROSS FLOW PLUG KIT					
	<ul style="list-style-type: none"> • cross flow plug and two rubber check valves • for M-CORE® mixing valve 	200763	5.75	-	12
ADJUSTABLE TEMPERATURE LIMIT STOPS					
	<ul style="list-style-type: none"> • Legend® or Chateau® • stop tube with adjustable temperature limit stop 	10510	29.10	Chrome	30
	<ul style="list-style-type: none"> • Moentrol® • stop tube with adjustable temperature limit stop 	10066	29.10	Chrome	125
		10066BN	41.10	Brushed Nickel	20
		10066NL	41.75	Polished Nickel	20
		10066WR	45.40	Wrought Iron*	20
<i>*Wrought Iron can be used with Oil Rubbed Bronze finish</i>					
	<ul style="list-style-type: none"> • Posi-Temp® • adjustable temperature limit stop 	96987	11.30	Chrome	20
		96987BN	15.95	Brushed Nickel	20
		96987NL	16.05	Polished Nickel	20
		96987BG	15.95	Brushed Gold	20
		96987WR	17.05	Wrought Iron*	20
<i>*Wrought Iron can be used with Oil Rubbed Bronze finish</i>					
	<ul style="list-style-type: none"> • temperature limit stop kit, Posi-Temp® single-handle tub/shower 	106479	5.45	-	300
SHOWER VALVE PUSH-BUTTON DIVERTER PLUG					
	<ul style="list-style-type: none"> • push-button diverter plug 	101100	36.35	-	100





Moentrol® and Legacy Transfer Valve Trim







		MODEL	LIST	FINISH/CONNECT	CASE QTY
MOENTROL® VALVE ONLY TRIM - ALIGN					
 <ul style="list-style-type: none"> • valve sold separately 		T3291	197.55	Chrome	3
		T3291BN	420.80	Brushed Nickel	3
		T3291BG	420.80	Brushed Gold	3
MOENTROL® VALVE ONLY TRIM - VOSS					
 <ul style="list-style-type: none"> • valve sold separately 		T3691	189.60	Chrome	3
		T3691BN	403.80	Brushed Nickel	3
		T3691BG	403.80	Brushed Gold	3
		T3691NL	403.80	Polished Nickel	3
		Q3 NEW! T3691BL	417.05	Matte Black	3
		T3691ORB	444.40	Oil Rubbed Bronze	3
MOENTROL® VALVE ONLY TRIM - KINGSLEY					
 <ul style="list-style-type: none"> • valve sold separately 		T3111	184.40	Chrome	3
		T3111BN	430.30	Brushed Nickel	3
		T3111ORB	473.40	Oil Rubbed Bronze	3
MOENTROL® WITH INTEGRATED TRANSFER VALVE TRIM - ROTHBURY					
 <ul style="list-style-type: none"> • valve sold separately 		TS4211	362.35	Chrome	3
		TS4211BN	496.15	Brushed Nickel	3
		TS4211ORB	522.65	Oil Rubbed Bronze	3
MOENTROL® WITH INTEGRATED TRANSFER VALVE TRIM - ALIGN					
 <ul style="list-style-type: none"> • valve sold separately 		T3290	229.60	Chrome	3
		T3290BN	308.40	Brushed Nickel	3
		T3290BL	339.25	Matte Black	3
MOENTROL® WITH INTEGRATED TRANSFER VALVE TRIM - KINGSLEY					
 <ul style="list-style-type: none"> • valve sold separately 		T4111	239.10	Chrome	3
		T4111BN	321.15	Brushed Nickel	3
		T4111ORB	353.20	Oil Rubbed Bronze	3
MOENTROL® TRIM CONVERSION KIT					
 <ul style="list-style-type: none"> • adapter for standard single-handle tub/shower valves to use Moentrol® trim • attaches to standard valves to fit today's Moentrol® trim 		145058	21.05	-	50

GENUINE PARTS

		MODEL	LIST	FINISH/CONNECT	CASE QTY
3 INDEPENDENT FUNCTION TRANSFER VALVE ONLY TRIM - ALIGN					
 <ul style="list-style-type: none"> • use with 3362 transfer valve • valve sold separately 		T4192	151.75	Chrome	12
		T4192BN	205.65	Brushed Nickel	12
		T4192BG	205.65	Brushed Gold	12
		T4192BL	226.20	Matte Black	12
2/3 FUNCTION TRANSFER VALVE ONLY TRIM - ALIGN					
 <ul style="list-style-type: none"> • use with 3372 or 3375 transfer valve • valve sold separately 		T4191	153.05	Chrome	12
		T4191BN	205.65	Brushed Nickel	12
		T4191BG	205.65	Brushed Gold	12
		T4191BL	226.20	Matte Black	12
3 INDEPENDENT FUNCTION TRANSFER VALVE ONLY TRIM - VOSS					
 <ul style="list-style-type: none"> • use with 3362 transfer valve • valve sold separately 		T4612	146.90	Chrome	12
		T4612BN	197.35	Brushed Nickel	12
		T4612BG	197.35	Brushed Gold	12
		T4612NL	197.35	Polished Nickel	12
		T4612BL	205.65	Matte Black	12
		T4612ORB	217.05	Oil Rubbed Bronze	12
2/3 FUNCTION TRANSFER VALVE ONLY TRIM - VOSS					
 <ul style="list-style-type: none"> • use with 3372 or 3375 transfer valve • valve sold separately 		T4611	146.90	Chrome	12
		T4611BN	197.35	Brushed Nickel	12
		T4611BG	197.35	Brushed Gold	12
		T4611NL	197.35	Polished Nickel	12
		T4611BL	205.65	Matte Black	12
		T4611ORB	217.05	Oil Rubbed Bronze	12
2/3 FUNCTION TRANSFER VALVE ONLY TRIM - KINGSLEY					
 <ul style="list-style-type: none"> • use with 3372 or 3375 transfer valve • valve sold separately 		T4311	159.70	Chrome	6
		T4311BN	214.70	Brushed Nickel	6
		T4311ORB	236.05	Oil Rubbed Bronze	6

GENUINE PARTS

		MODEL	LIST	FINISH/CONNECT	CASE QTY
COVER PLATES FOR THE BATH					
	<ul style="list-style-type: none"> remodeling cover plate, for two- and three-handle tub/showers fits all single-handle tub/showers with 7" escutcheon 	1920	73.15	Chrome	6
		1920BN	106.20	Brushed Nickel	6
		1920ORB	130.35	Oil Rubbed Bronze	6
	<ul style="list-style-type: none"> remodel cover plate, for two and three-handle tub/showers fits Posi-Temp® valves 	178755	81.65	Chrome	8
		178755BN	118.40	Brushed Nickel	8
		178755ORB	125.70	Oil Rubbed Bronze	8
	<ul style="list-style-type: none"> Moenique® service kit, single-handle tub/shower with 3960 tub spout handle not included 	14292	251.00	Chrome	1
LAVATORY CONVERSION KIT - KNOB TO LEVER HANDLE					
	<ul style="list-style-type: none"> handle conversion kit, knob to lever, Chateau® single-handle lav - Models prior to April 2003 	100679	68.70	Chrome	12
TUB/SHOWER CONVERSION KITS - KNOB TO LEVER HANDLE					
	<ul style="list-style-type: none"> lever handle kit, Moentrol® single-handle tub/shower 	100224	23.25	Chrome	45

		MODEL	LIST	FINISH/CONNECT	CASE QTY
LAVATORY WASTE ASSEMBLIES					
	<ul style="list-style-type: none"> • lavatory drain assembly • all metal 	10790	134.10	Chrome	12
	<ul style="list-style-type: none"> • lavatory drain assembly • spring loaded push button • with overflow 	131553 131553BN 131553BG 131553NL 131553ORB 131553BL	86.45 117.95 129.55 117.95 128.20 132.70	Chrome Brushed Nickel Brushed Gold Polished Nickel Oil Rubbed Bronze Matte Black	12 12 12 12 12 12
	<ul style="list-style-type: none"> • lavatory drain assembly • ideal for vessel sinks • spring loaded push button • without overflow 	140780 140780BN 140780BG 140780NL 140780ORB 140780BL	76.80 107.05 107.05 107.05 128.75 120.90	Chrome Brushed Nickel Brushed Gold Polished Nickel Oil Rubbed Bronze Matte Black	12 12 12 12 12 12
	<ul style="list-style-type: none"> • grid drain without overflow 	123816 123816BN 123816ORB 123816BL	60.80 85.15 94.00 94.00	Chrome Brushed Nickel Oil Rubbed Bronze Matte Black	12 12 12 12
	<ul style="list-style-type: none"> • lavatory drain assembly, non-metallic • lavatory drain assembly, non-metallic plug, metal seat • lavatory drain assembly, non-metallic plug, metal seat 	14526 96497 96107	14.95 25.75 19.55	Chrome Chrome Chrome (Carded)	1 12 18
	<ul style="list-style-type: none"> • pivot rod extension linkage • designed to bridge gap between faucet lift rod and sink drain assembly • adjustable • wing nuts to allow for simple setting of desired range • pivot rod and perforated strap are not included 	98085	7.10		225
DRAIN PLUG & SEAT					
	<ul style="list-style-type: none"> • lavatory drain plug and threaded seat assembly • non-metallic • works with metal drain body 10790 only 	10709 10709BC 10709BN 10709BG 10709NL 10709ORB 10709BL 10709WR 99596	14.85 20.75 46.35 46.35 50.95 51.05 51.05 51.05 43.35	Chrome Brushed Chrome Brushed Nickel Brushed Gold Polished Nickel Oil Rubbed Bronze Matte Black Wrought Iron Polished Brass	84 20 20 20 20 20 20 20 1

GENUINE PARTS

Moen Genuine Parts

Listed in numerical order

Part Number	List	Finish	Description	Part Number	List	Finish	Description
221	63.90	Chrome	ESCT CHT/CNTX/LGD TS 1H CHR	12689	18.25	N/A or Unfinished	PR&CLPASSYBRASS LAVWA
441	67.20	Chrome	ESCT MNT 1HTS CHR	12694	9.80	Chrome	LIFT ROD LAV MWS/ WS/1H/2H CHR
739	137.50	Chrome	SPT 9 CHT KD 7500 SR & 67503	12715	43.05	N/A or Unfinished	HDW MTG CHT/CNTX/TRAD WSLAV
785	22.70	N/A or Unfinished	HDW LGD/CHT LAV 1H	13291	62.05	Chrome	HDL EZG RPLCMNT MNT TS
883	4.55	N/A or Unfinished	RTNR CLP KNB HDL LAV&TS	13393	61.45	Chrome	HDL EZG RPLCMNT CHT LAV
1039	44.90	N/A or Unfinished	UNIVERSAL MOUNT SINK FLANGE KIT	13401	13.55	N/A or Unfinished	CRTRGE,NUT CHT WS LAV/ RTDM-2
1041	450.05	N/A or Unfinished	DISP UNJAM WRENCH - 100 UNIT BULK PACK	13462	10.30	N/A or Unfinished	ADPT HDL CHT WS RDMTF HI-F
1185	12.65	N/A or Unfinished	WASTE SEAT LAV CHR	13463	13.40	N/A or Unfinished	STM EXT CHT WS RDMTF HI-F
1198	57.00	N/A or Unfinished	PBD MN MNT SHR STANDARD	13499	45.05	Chrome	HDL EZG RPLCMNT MN CHT TS
1207	8.55	Chrome	ST TUBE LGD,CHT&BTQ 1H LAV CHR	13678	10.35	N/A or Unfinished	HDW MN KD/LAV/BAR 2H
1306	28.15	Chrome	HDL CVR MN KD LRLAV	13769	38.45	Chrome	ESCT CHT/MNII/TC TS2&3H/ WSRND CHR 1
1371	116.30	N/A or Unfinished	ATD MTCL VLV WS LAV HOT	13774	14.75	Chrome	WALL TUBE 2H TS CHR 1
1373	121.95	N/A or Unfinished	ATD MTCL VLV WS LAV COLD	13797	18.25	N/A or Unfinished	CRTRGE,NUT MN 2H TS
1380	375.50	Chrome	RDMTF CHT 12 SF CHR	13805	21.90	N/A or Unfinished	HDW LGD KD 7300 SR
1381	325.40	Chrome	RDMTF CHT 7 SF CHR	13903	5.30	N/A or Unfinished	ATD SCRW 10-24 UNC 1.00 HEXST BG
1394	56.55	Chrome	PBD EXT 1.000 2400 & 3250 SR	14187	21.35	N/A or Unfinished	GRTR SPRING ONLY KD RISER
1411	25.15	Chrome	ESCT UNIVERSAL HHH DKMT CHR	14289	13.30	N/A or Unfinished	HDW PACK CHAL 2H KNB
1417	60.05	Chrome	INTL SHR ELBOW HHH DKMT CHR	14290	80.30	Chrome	HDL ASSY ONLY #7345
1423	120.70	N/A or Unfinished	BALSPL MNT TS	14291	8.75	N/A or Unfinished	NSRT HDL CVR OR SPT LGD KD RISER
1512	10.25	Chrome	PLUG BUTTON WS RDMTF CHR	14349	25.30	Chrome	ESCT CHT/SANI BDT/LAV/TS WS CHR
1694	73.80	Chrome	P-OS COLLAR & NUT KIT CHR	14369	12.25	N/A or Unfinished	HDL KNB MNII 2H CHR CAN 1
1883	19.30	N/A or Unfinished	RTNR CLP KD LR (6 PER PACK)	14373	19.75	N/A or Unfinished	HOSE CHT WS LAV
1931	108.55	Chrome	SPT RCPTLR LGD/TC KD P-OS CHR	14582	39.45	Chrome	ESCT BTQ TS WS RDMTF CHR
1933	28.75	Chrome	ESC LGD/TC P-OS VBSGLMT CHR	14666	118.25	Chrome	HDL HUB TRAD LR H CHR 1
1935	32.20	Chrome	ESCT LGD/TC P-OS VB CHR	14671	118.25	Chrome	HDL HUB TRAD LR C CHR 1
2011	20.30	Chrome	LIFT ROD LAV WACHR	14699	8.70	N/A or Unfinished	RTNR PVT NUT LH SGL HDL KD
2021	122.50	Chrome	HDL ASSY LGD KD 7300 SR	14705	62.35	Chrome	HDL TRAD LR NSRT CHR CRD 2
2060	142.70	N/A or Unfinished	CRTRGE 5FXFER VLV	14725	42.50	Chrome	HDL TRAD LR NSRT (1) CHR
2186	16.85	Chrome	STRM-F ASSY MTCL MALE CHR (1)	14732	31.70	Chrome	LR MTCL KIT CHT POSI TS CHR
2187	24.30	Chrome	ESCT MTCL RDMTF CHR	14855	12.65	N/A or Unfinished	HOSE, KD RISER
2197	213.90	Chrome	RDMTF MTCL 10 SF CHR	14913	16.30	Chrome	STRM-F ASSY TRAD MALE CHR
2198	16.80	Chrome	ESCT MTCL BDT/LAV/KD/TS 2H&WS HDL CHR	14960	19.70	N/A or Unfinished	D SRVC KIT CHT/TC 2H KD
3830	75.30	Chrome	DIVERTER TUB SPOUT, IPS CHR	14986	8.35	N/A or Unfinished	CRTRGE,NUT CHT 2H
4000	13.00	N/A or Unfinished	KEROX VLV CARTRIDGE KIT	15528	12.45	Chrome	ESCT SCRW LGD/MNT/CHT TS CHR 2
10048	20.35	N/A or Unfinished	LIQUID DISPENSER BOTTLE	16015	7.20	N/A or Unfinished	PIVOT SEAT LAV WASTE
10089	11.95	Chrome	STOP TUBE SHWR STNL STL DGRSD	16090	40.75	Chrome	ESCT CHT TS 1H CHR
10099	4.85	N/A or Unfinished	D CHT/MTCL/TRAD 2H WS TS	16331	51.85	N/A or Unfinished	HDW MTG MTCL MWS SPT
10116	4.95	Chrome	ESCT PLUG LAV CHR	22526	19.40	N/A or Unfinished	TEMPLATE/INST SHT UMT SINK G18252
10644	19.05	N/A or Unfinished	REPAIR KIT ABS TUB SPT	54035	37.65	Chrome	4" LEVER SMOOTH
10927	47.80	Chrome	HDL LR LGD/SANI KD 1H CHR	90274	16.75	N/A or Unfinished	ADPT WS WH SRVC KIT - 2
11854	12.75	N/A or Unfinished	HDW MTG TRAD HUB	90276	4.55	N/A or Unfinished	ADPT FOR MN WS RDMTF
11926	43.05	N/A or Unfinished	HDW MTG CHT LAV MWS	90462	34.15	Chrome	TW FACE PLATE TRIP LEVER W/SCREWS CHR
11977	5.30	Chrome	PLUG BUTTON TRAD POSI/M&WS CHR	90467	17.15	Chrome	TW COVER GRID W/SCREW CHR
11985	7.55	N/A or Unfinished	PIVOT ROD ASSY, BIDET NM WA (SK)	90471	27.10	Chrome	TW FACE PLATE 1 HOLE W/ SCREW CHR
11997	5.50	N/A or Unfinished	HDW MTG 50/50 WA	90478	11.50	Chrome	TW MTG SCREW FACE PLATE 2 CHR
12314	24.05	Chrome	WASTE PLUG ASSY NON-MET LIC WA	90481	16.90	N/A or Unfinished	TW GASKET ALL MODELS
12318	50.25	N/A or Unfinished	CKST MNT TS	90483	28.50	N/A or Unfinished	TW LIFT ASSY BRASS TP-LR
12343	10.35	Chrome	STM EXT CHT WS RDMTF (1)	91110	68.15	Chrome	HDL EXT 1.000 CHT TSWING HANDLE
12536	4.55	N/A or Unfinished	SCRW, 10-32 UNF .38 CAP HD SS BAG	91192	33.75	N/A or Unfinished	D SRVC KIT LR KD
12539	11.20	N/A or Unfinished	NUT ESCT 2H BAR/KD/LAV/LDRY DOM	91194	98.40	Chrome	SPT 9 LGD KD 7300 SR & 67300
12550	17.40	N/A or Unfinished	HDW MTG RMDLG CVR PLT CHR	91244	32.90	N/A or Unfinished	HDL KNB KIT 3179 SPECIAL
12570	19.05	N/A or Unfinished	HDW MTG RDMTF HI-F	91888	66.25	Chrome	ACC PUL SHR HH VOLUME CONTROL VLV
12573	8.75	N/A or Unfinished	ATD LD BUSHING RING (1)	91992	72.30	Chrome	SPT CHT 2H LDRY CHR
12574	11.30	N/A or Unfinished	ATD PLSTR GRND POSI ALL VLV(1)	92309	24.80	N/A or Unfinished	RTNR PVT NUT SGL HDL KD
12639	13.30	N/A or Unfinished	HDW SRVC KIT POSI STOP VLV	92451	8.60	N/A or Unfinished	H-P CART SERV KIT
12648	4.20	N/A or Unfinished	HDW PACK 2H KNOB SCREWS (2)	92455	9.40	N/A or Unfinished	EXT & SCREW ASSY DRAIN ROD

Moen Genuine Parts

Listed in numerical order

Part Number	List	Finish	Description	Part Number	List	Finish	Description
93944	36.80	Chrome	HDLHUBMNII CHR2	97547	44.50	Chrome	ESCTMTCLMWSHDLCHR (1)
93959	15.85	N/A or Unfinished	HDWMTGCHT/MN/MNR/ MTCL KD 1H	97556	26.80	N/A or Unfinished	HDLADPTMTCLMWS/2H H & C
93960	18.10	N/A or Unfinished	VALUERTNR PVT NUT KD 1H	97559	77.15	Porcelain/Chrome	HDLMTCLLRNSRT SMPOR/C CRD2
93964	26.95	N/A or Unfinished	HDWPACKVALUEPLT&GSKT	97564	5.35	N/A or Unfinished	GSKTDECKMTCL2HLAV
93970	10.20	Chrome	HDLCAPMN/MNR1HKDCHR	97565	65.15	N/A or Unfinished	MTGHDWMTCLWSLAV
93971	80.50	Chrome	HDLASSYVALUE1HKDCHR	97577	62.95	Chrome	ESCTMTCL1HTSCHR
93973	87.80	Chrome	SPT 9 VALUEKD1HCHR	97800	8.55	N/A or Unfinished	PLASTERGROUNDCHT1H TSBAG
93980	34.75	N/A or Unfinished	HDLHDWGOODKD1H	97996	10.60	N/A or Unfinished	POSITSDECAL (1 PACKAGE OF 10)
93988	103.30	Chrome	SPT 9 SOFT-D KD 1HCHR	98035	32.00	N/A or Unfinished	HDLKNBTC LAV1HCLW/C CRD
93989	82.40	Chrome	LRGOODKD1HCHR	98036	13.50	N/A or Unfinished	NSRTKNBTC LAV/TS1H W/C CRD
93990	15.95	Chrome	HDLDOME SM KD 1HCHR	98037	32.00	N/A or Unfinished	HDLKNBTC TS1HCLW/C CRD
93995	60.00	Chrome	ESCTCHT/TC KD 1HRDCHR	98079	29.65	N/A or Unfinished	HDWMTGCHTBDTLIFT ROD ESCT
94146	11.80	N/A or Unfinished	CRTRGE,NUTCHT2HTS	98082	49.10	N/A or Unfinished	PRASSYBDTWA
94435	42.95	Chrome	ESCTRNGCHT/MN/MTCL1H KDCHR	98213	6.30	N/A or Unfinished	GSKTDECKKD1HCHT/LGD
94543	31.60	N/A or Unfinished	TMEXTCHT3VTSCTR (1)	98430	14.90	N/A or Unfinished	GSKT,ESCTLGD/TC KD P-OS
94740	37.80	Chrome	HDLASSYCHT/MNT/POSI LRCHR	98576	26.20	Chrome	ESCTMTCLTUBSPTCHR
94746	11.80	N/A or Unfinished	ADPTHDLMNT/CHT1HLVR T/S	99479	22.60	N/A or Unfinished	HDWMTGCHTBDTDVRTR
94750	16.30	Chrome	HDL COLLAR CHT/TC 1HLR LAV/CHR	99712	13.40	Chrome	HDL CAPCHT KD 1HLCHR1
94770	6.70	Chrome	PLUGBUTTON & SET SCREW	99892	8.20	N/A or Unfinished	SCRW,5/16-18UNCHEXSET BAG
94773	28.00	N/A or Unfinished	STMEXTMNT1HLR HDL TS	100000	12.20	N/A or Unfinished	SPT O-RING KIT CATH 1H KD
94786	4.95	N/A or Unfinished	HDWMTG SCRW&WSHRMNT 1HLR	100008	21.85	N/A or Unfinished	DWMTGMTCLVLVKD1H CATH
94791	5.40	N/A or Unfinished	HDLADPT SCRW1HT/S	100009	190.05	Chrome	SPT10MTCLCATHKD1HCHR
94794	46.95	N/A or Unfinished	HDWRMNTG DECKPOST,DVRTRVLV	100011	31.60	Chrome	ESCTRNGKD1H SGLMTCHR
94831	82.90	N/A or Unfinished	DSRVC KIT BDT	100012	44.50	Chrome	HDL MN/MTCL/PTKD1H SOLID CHR
94854	56.55	N/A or Unfinished	CRTRGE DVRTRVLV	100014	23.60	Chrome	HDL DOME LRG KD 1H CHR
94873	22.45	N/A or Unfinished	CHECKVALVE P-OS	100016	97.80	Chrome	SPT 10MTCL KD 1H CHR
94996	4.95	N/A or Unfinished	O-RING BAGGED (3)	100021	19.35	Chrome	Hdl Cap CHT MN KD 1H CHR
94998	60.65	N/A or Unfinished	HOSE,LEADER,RT DVRTR	100023	38.35	Chrome	DL CAPCHT/MN KD 1H PORCELAIN CHR/GLC
95606	29.75	Chrome	HDLHUBMTCL POSI KIT CHR 1	100024	11.65	N/A or Unfinished	TL MNT TS 3F CHR
95612	43.05	Chrome	ONEPC HUBMTCL MNT KIT CHR	100112	18.80	Chrome	FRAMALE THRD MTCL LG 2.2 GPM CHR CRD
95626	43.05	Chrome	ONEPC HDL HUBMTCL POSI KIT CHR	100113	22.90	Chrome	FRAMALE THD MTCL SM 2.0GPM CHR
96217	55.05	Chrome	WALLTUBECHT3VTSCHR (1)	100119	52.85	N/A or Unfinished	HOSE SUPPLY SPT CATH 1HKD
96469	86.00	Chrome	LD PUMP & NOZZLE ASSY CHR	100131	18.80	Chrome	LIFT ROD VIL MWS/WS CHR
96792	34.05	N/A or Unfinished	CHTLAV1HCLW/G	100138	42.45	N/A or Unfinished	KNBADPT KIT XFER 5F
96798	34.05	N/A or Unfinished	HDLKNBCHT TS 1HCLW/G	100140	22.70	N/A or Unfinished	HDL GRIP RING XFER 5F
96804	10.80	N/A or Unfinished	HDWKNBLAV1HALL MODELS	100150	53.40	Chrome	HDL LR NOVA LOOP CHR
96806	10.80	N/A or Unfinished	HDWKNB TS 1HALL MODELS	100151	31.35	Chrome	ESCTNOVA KD 1H SGLMTCHR
96884	34.30	N/A or Unfinished	HDLKNBKIT HOTEL 1H POSI CL	100154	54.85	Chrome	HDL NOVA TRAD 1HKD CHR
96885	53.40	Chrome	ESCTCHT/TC TS 1H POSI CHR	100155	20.40	Chrome	HDL CAPNOVA KD 1H P-OS CHR
97274	5.60	N/A or Unfinished	NSRT KIT MTCL RED&BLUE LR HDL	100202	13.30	N/A or Unfinished	KNBADPT KIT XFER 3F MTCL MNT
97344	14.55	N/A or Unfinished	STMEXTMTCL2HTS (2)	100205	9.75	N/A or Unfinished	SET SCREW KIT 8-32 X .370
97361	10.80	Chrome	ESCTMTCL2HTS CHR (1)	100214	20.25	N/A or Unfinished	HDLADPT/BRAKE LR VIL MNT 1HTS
97371	7.75	N/A or Unfinished	HDLADPT KIT MTCL 2HTS WSLAV 1	100216	16.90	N/A or Unfinished	CRTRGE CAP&NUT KIT METERING CHR
97372	65.35	Chrome	HDLMTCLLRNSRT LRG CHR CRD2	100223	9.00	N/A or Unfinished	HDLADPT&BRAKE KIT LR CHT/MNT
97373	75.30	Polished Brass	HDLMTCLLRNSRT LRG PB CRD2	100226	44.45	Chrome	HDLASSY KD 1H CHR
97376	88.50	Porcelain/Chrome	HDLMTCLLRNSRT LRG POR/C CRD2	100227	89.25	Chrome	SPT ASSY KD 1H CHR
97434	140.15	Porcelain/Chrome	HDLMTCLCXNSRT LRG POR/C2	100230	65.35	Chrome	SPT ASSY HARC KD 2H
97446	131.35	Chrome	HDLMTCLCXNSRT LRG CHR 2	100232	46.35	Chrome	HDL HUBLVR C CHR
97462	44.70	Chrome	HDLMTCLLRNSRT LRG CHR CRD 1	100233	47.65	Chrome	HDL HUBLVR H CHR
97463	51.40	Polished Brass	HDLMTCLLRNSRT LRG PB BGD	100242	7.60	N/A or Unfinished	HDL LVR KIT CHR
97466	51.40	Porcelain/Chrome	HDLMTCLLRNSRT LRG POR/C CRD 1	100250	16.55	Chrome	CAP, SPOUT KD 2H CHR
97479	23.40	N/A or Unfinished	STEMEXT MTCL WSLAV HOT & COLD	100251	3.30	N/A or Unfinished	WSHR, BEARING KD 2H
97491	65.15	Chrome	ESCTMTCL 1H POSITS CHR	100254	77.05	Chrome	SPOUT ASSY KD 2H CHR
97535	5.40	N/A or Unfinished	CRTRGE,NUT MTCL MWS LAV (2)	100255	22.60	N/A or Unfinished	DSRVC KIT 2H KD
				100263	12.50	N/A or Unfinished	KNBINSRT KD 2H
				100265	22.50	N/A or Unfinished	HDLKNB2H SML CL
				100270	6.30	N/A or Unfinished	HDL CONN 1H LR LAV/TS

GENUINE PARTS

Moen Genuine Parts

Listed in numerical order

Part Number	List	Finish	Description
100283	2.05	N/A or Unfinished	GASKET, DECK2H
100429	7.60	N/A or Unfinished	ADPT/CONN HDL PT/SHARK
100439	16.30	Chrome	DOME CLND/EXTA/PT/ SALORA 1HKD LR CHR
100440	34.40	N/A or Unfinished	HDW MTG PT HDL KD 1H
100538	9.35	N/A or Unfinished	BRASS TEST PLUG RT
100539	15.35	N/A or Unfinished	MOUNTING WASHERS
100541	30.70	N/A or Unfinished	HDLADPTR H&C L4720
100552	98.75	Chrome	HDL, MTCL MWS 2H LVR COLD CHR
100553	98.75	Chrome	HDL, MTCL MWS 2H LVR HOT CHR
100556	40.20	Chrome	HDL, MTCL WS 2H LVR LAV & BDT CHR
100557	46.45	Chrome	HDL, MTCL WS 2H CX LAV & BDT CHR
100558	46.15	Chrome	HDL, MTCL WS 2H LVR TS & KD CHR
100559	52.35	Chrome	HDL, MTCL WS 2H CX TS & KD CHR
100561	13.65	N/A or Unfinished	HDLADPTR KIT MTCL MWS 2H HOT & COLD
100562	5.35	N/A or Unfinished	HDLADPTR KIT MTCL WS 2H LAV & BDT
100563	5.30	N/A or Unfinished	HDLADPTR KIT MTCL WS 2H TS & KD
100566	14.75	N/A or Unfinished	SMALL CHASSIS, MTCL
100593	138.75	N/A or Unfinished	HOSE & VAC BRKR CONVERSION KIT
100602	129.85	N/A or Unfinished	VACUUM BREAKER CONVERSION KIT
100615	37.65	Chrome	ESC, KD, CHR
100616	63.30	Chrome	SPT KIT, KD, CHR
100617	21.85	Chrome	HDL, INSRT, H&C, SK
100621	67.35	Chrome	LEVER HDL KIT, CHR, COLD
100624	67.35	Chrome	LEVER HDL KIT, CHR, HOT
100625	32.00	Chrome	ESCT, BAR, CHR, SK
100626	46.25	Chrome	SPT, ASSY, BAR, CHR, SK
100649	147.70	Chrome	SPT, WS, CHR, SK
100650	15.00	Chrome	ESC, WS, CHR, SK
100652	169.15	Chrome	SPT, RT, CHR, SK
100655	39.20	Chrome	LIFT ROD, DVRTR, CHR, SK
100656	143.70	Chrome	PT, GT, CHR, SK
100657	29.75	Chrome	HDL TC POSI 1H TS LR CHR
100665	41.25	Polished Brass	SPT, LDRY, ASSY
100667	147.70	Chrome	SPT, WS, ASSY, W/O LR
100675	162.00	Polished Brass	SPT, ASSY, GT, W/ENDFORM
100676	45.45	N/A or Unfinished	CHT ITT WS VALVE BODY
100683	6.85	N/A or Unfinished	GSKT DECK CHT/SANI 2H LAV
100695	43.95	N/A or Unfinished	KNOB KIT, H & C
100702	37.15	N/A or Unfinished	WIDESPREAD SPOUT SHANK FOR HYDROLOCK
100742	49.80	N/A or Unfinished	WIDESPREAD VALVE FOR HYDROLOCK, HOT
100743	49.80	N/A or Unfinished	WIDESPREAD VALVE FOR HYDROLOCK, COLD
100746	25.65	Chrome	SIP TRANSITIONAL HANDLE KIT CHR
100816	29.15	N/A or Unfinished	SIDE SPRAY EXTENSION KIT
100820	83.55	Chrome	SIP MODERN SPOUT KIT CHR
100895	29.10	Chrome	SIP MODERN HANDLE KIT CHR
100896	88.50	Chrome	SIP TRADITIONAL SPOUT KIT CHR
100928	29.75	Chrome	SIP TRADITIONAL HANDLE KIT CHR
100957	27.55	Chrome	SIP ESCUTCHEON W/LED INDICATOR CHR
100961	147.80	Chrome	SIP TRANSITIONAL SPOUT KIT CHR
100998	16.10	Chrome	ESC, T/S KIT
101010	17.15	Chrome	MALE THREAD 1.5GPM AERATOR
101029	18.50	Chrome	FEMALE THREAD 1.5GPM AERATOR
101039	15.35	N/A or Unfinished	HDW MTG ROUGHIN HI-FT/S
101048	22.40	Chrome	5GPM AERATOR, MALE THREAD CHR

Part Number	List	Finish	Description
101076	6.20	Chrome	FRA FEMALE THRD 1.5GPM CHR CRD
101077	15.45	Chrome	FRA FEMALE THRD 1.5GPM CHR
101099	7.55	N/A or Unfinished	HDL CONN 1H KD LGD
101140	37.50	Chrome	1H LAV HANDLE KIT, LEVER CHR
101146	17.15	Chrome	MALE THREAD 1.0GPM AERATOR
101199	8.10	N/A or Unfinished	SCREEN WSHR KD P-OS 0 X 60 MESH
101209	41.05	Chrome	HDL LR CHT/MNT CHR MRKD
101237	9.40	N/A or Unfinished	CUP SEAL/DVRTR GATE 3800 SPOUT
101246	97.95	Chrome	SPT RCPTR LGD/TC KD P-OS CHR
101249	19.05	Chrome	HDL COLLAR & NUT P-OS 1H KD CHR
101257	17.15	Chrome	AERATOR BODY P-OS MALE THRD CHR
101310	24.30	Chrome	HDW HDL CHT LAV 1H LR
101412	33.25	Chrome	HDL WS CHR
101484	108.55	Chrome	SPT RCPTR LGD/TC KD P-OS CHR
101652	37.80	Chrome	TW DRAIN TOUCH DRAIN 1.50 CHR
101653	37.15	Chrome	TW DRAIN LIFT-N-DRAIN 1.50 CHR
101707	21.35	N/A or Unfinished	EXTAVB HUB ASSY
101708	82.70	N/A or Unfinished	HOSE ASSY 59 SPIRAL KD P-OS BAG CHR
101869	28.65	N/A or Unfinished	HDW MTG HDL LVW/ATLS
101879	7.95	N/A or Unfinished	HDW PACK SPOUT RETAINERS
101951	21.75	N/A or Unfinished	DVRTR ROD RMN TUB CHR
101952	27.95	N/A or Unfinished	HDR DVRTR KIT ROMAN TUB
101964	26.15	Chrome	FRA FEMALE THRD 2.2GPM CHR
101965	7.60	N/A or Unfinished	DECK GSKT
101975	5.45	N/A or Unfinished	POSI FLUSHING PLUG KIT
102562	13.95	Chrome	2T TUBE VIL T/S CHR
102564	63.65	Chrome	HDL LR VIL 1H TS CHR
102565	46.15	Chrome	HDL LR VIL 1H LAV CHR
102566	9.80	Chrome	HDL COLLAR VIL 1H LAV LR CHR
102567	5.45	Chrome	HDL STOP VIL LR 1H LAV CHR
102568	19.80	N/A or Unfinished	VIL LAV LR ST
102570	40.10	Chrome	LIFT ROD VIL 1H LAV CHR
103432	6.50	N/A or Unfinished	HDW PACK SPT 2H KD TRAD
103433	111.90	Chrome	SPT 2H KD CHR
103437	6.70	N/A or Unfinished	CONN 1H KD
103454	82.50	Chrome	HDL KNB MTCL BDT DVRTR CHR
103455	84.40	Chrome	SPRYNZL SHRHD & AER MTCL BDT CHR
103456	29.40	N/A or Unfinished	HDW PACK HDLADPT MTCL TS MWS
103460	10.65	N/A or Unfinished	MPACT DRAIN PLUG O-RING
103462	12.30	N/A or Unfinished	MTCL MWS & WS INSTALL TOOL
103463	42.30	Chrome	MTCL SPT ESCT WS LAV CHR
103464	23.25	Chrome	LIFT ROD & KNB WS CHR
103465	8.55	N/A or Unfinished	SET SCRW LIFT ROD
103466	6.50	N/A or Unfinished	MTCL SPT O-RNG WS LAV CHR
103468	167.05	Chrome	MTCL SPT WS LAV CHR
103469	61.00	N/A or Unfinished	MTCL SPLY HOSE WS LAV
103674	300.15	N/A or Unfinished	THR MSTC CRTRGEXTMP
103675	41.60	Chrome	THR MSTC LOWER SHELL CHR
103678	23.20	Chrome	ESCT RNG MTCL CHR
103685	38.20	N/A or Unfinished	TEMP RTNG NUT XTMP
103686	22.60	N/A or Unfinished	CHECK-STOP XTMP
103687	72.35	N/A or Unfinished	CHECK STOP ASSY XTMP
103688	32.45	N/A or Unfinished	THR MSTC CRTRG PARTS XTMP
103689	35.10	N/A or Unfinished	TEMP STOP XTMP
103690	19.10	N/A or Unfinished	SPINDLE XTMP
103691	4.90	N/A or Unfinished	SPINDLE SCRW XTMP
103692	28.10	N/A or Unfinished	FLOW RTNG NUT XTMP

Moen Genuine Parts

Listed in numerical order

Part Number	List	Finish	Description	Part Number	List	Finish	Description
103745	72.25	Chrome	ESCT MWS HDL BGD CHR	115010	70.95	N/A or Unfinished	SPT BASE KIT MTCL 1H CATH KD
103759	11.95	N/A or Unfinished	CLP ESCT & MTG WSHR WS HDL	115012	278.15	N/A or Unfinished	CABLE ASSY SENSOR EYE 8' WALL MNT KIT
104212	13.55	N/A or Unfinished	TOOL AERATOR DRIVER ASCR WSLAV	115023	7.85	Chrome	HDL CAP & TEMPERATURE IND 1H LAV CHR
104215	29.20	Chrome	LIFT ROD ASCR MWS CHR	115026	16.15	N/A or Unfinished	HDL STOP KIT
104217	11.00	Chrome	FRA MALE ASCR MWS CHR	115029	21.75	Chrome	HDL HUB 2H LAV & KD
104224	11.75	N/A or Unfinished	HDL ADPT ASCR MWS LAV HOT & COLD	115030	28.05	Chrome	LVR HDL HOT 2H LAV & KD
104225	12.05	N/A or Unfinished	LIFT ROD GUIDE ASCR LAV	115033	21.30	N/A or Unfinished	CERAMIC HDL TRIM 2H LAV & KD (1 ONLY)
104228	17.30	Chrome	FRA MALE THRD 2.2GPM ASCR HARC CHR	115034	13.40	Chrome	HDL CAP KIT 2H LAV & KD
104233	8.10	N/A or Unfinished	HDL ADPT ASCR WSLAV	115035	8.60	Chrome	HDL HUB 2H LAV & KD
104235	19.50	Chrome	ESCT PROTEGEW/HOSE GUIDE CHR	115036	28.25	Chrome	LVR HDL HOT 2H LAV & KD
104247	8.20	N/A or Unfinished	SHR ESCT RTNR SCRWS ASCR	115037	12.20	Chrome	SPT CAP 2H KD
104248	8.40	N/A or Unfinished	HDL CPLG ASCR MNT	115039	63.55	Chrome	SPT KIT 2H KD
104407	17.65	N/A or Unfinished	HDL HSG ASCR POSI	115043	58.60	Chrome	SPT 2H KD
104409	5.65	N/A or Unfinished	VLV STEM CPLG ASCR POSI	115045	10.30	Chrome	FRA FEMALE THRD 2.2GPM BNBY 2H KD CHR
104411	4.85	N/A or Unfinished	SET SCR W ASCR POSI HDL	115046	45.05	Chrome	HDL, 1H KD
104419	8.20	N/A or Unfinished	PLUG BTN & SET SCR WR MN TS ASCR	115047	64.80	Chrome	SPT, 1H KD
104635	165.35	N/A or Unfinished	0.125GPF SENSOR AND BRACKET	115051	32.30	Chrome	HDL HUB CHR
104636	165.35	N/A or Unfinished	0.5GPF SENSOR AND BRACKET	115055	13.30	Chrome	HDL CAP, SCR W CHR
104637	165.35	N/A or Unfinished	1.0GPF SENSOR AND BRACKET	115056	27.70	Chrome	LVR HDL, COLD, 2H LAV & KD
104638	165.35	N/A or Unfinished	1.0/1.6GPF SENSOR AND BRACKET	115057	5.95	Chrome	DECK GSKT, 2H LAV
104639	165.35	N/A or Unfinished	1.28GPF SENSOR AND BRACKET	115060	29.30	Chrome	HDL CSBY KD/LAV 2H LVR COLD BOX
104640	165.35	N/A or Unfinished	1.6GPF SENSOR AND BRACKET	115061	8.75	N/A or Unfinished	BEARING WSHR KIT, 1H KD
104641	165.35	N/A or Unfinished	3.5GPF SENSOR AND BRACKET	115062	5.45	N/A or Unfinished	GASKET, DECK KD 2H CSBY BK 20
106322	12.60	N/A or Unfinished	WST MNTG, METAL	115063	48.00	Chrome	LVR HDL, H & C CHR
106324	32.50	N/A or Unfinished	T-CONNCTR MTCL CATH KITCHENS	115066	8.60	Chrome	HDL ACCENT CHR
106376	25.35	Chrome	SHR BRKT 4-8 FNCTN CHR	115073	13.55	N/A or Unfinished	BACKING PLATE KIT -2708 THIN WALL
110307	5.85	N/A or Unfinished	AUQACR TRGE NUT	115077	88.15	Chrome	VACUUM BREAKER KIT CHR
110317	109.70	Chrome	HDL EXT 1.0003FXFERVLV CHR	116379	33.90	N/A or Unfinished	ONE TOUCH RETROFIT BRASS SPOUT NUT KIT
111881	29.20	Chrome	LVR HDL CHR	116618	18.50	Chrome	FRA FEMALE THRD 2.2GPM CHR
113173	11.55	N/A or Unfinished	MOUNTING HARDWARE SERVICE KIT	116620	27.25	Chrome	SPT HUB, 1H LAV CHR
113957	6.50	Chrome	PLUG BTN	116623	20.75	N/A or Unfinished	LOCKING RING, ROMAN TUB SPOUT
113958	6.90	N/A or Unfinished	GASKET, DECK LAV 1H CHT & TC BK 50	116626	74.00	Chrome	SPT KIT, WSLAV CHR
113959	8.75	Chrome	DOME CHT 1H LAV LR CHR	116628	16.85	Chrome	LVR HDL, WSLAV CHR
113973	25.30	Chrome	MINI BLADE HNDLS HOT & COLD	116629	58.15	Chrome	HDL HUB, WSLAV CHR
114295	20.35	N/A or Unfinished	HDW KIT, 7590 SERIES	116630	138.35	Chrome	SPT CAP, RT CHR
114299	39.85	N/A or Unfinished	HOSE KIT, 7592 SERIES CHR	116632	49.00	Chrome	BODY AERATOR FEMALE THRD RMN TUB CHR BK
114303	8.60	N/A or Unfinished	CRTRGE, NUT 7592 SERIES	116641	74.45	Chrome	SPT KIT, 1H KD CHR
114304	44.75	Chrome	HDL KIT 7590 SERIES CHR	116648	21.75	Chrome	LIFT ROD KIT
114306	21.35	N/A or Unfinished	HDW KIT ADPT HOSE QUICK CONNECT	116649	32.40	Chrome	SPT CAP, 2H LAV CHR
114307	24.75	N/A or Unfinished	DURALOCK KITCHEN/BAR QUICK CONN HOSE KIT	116653	8.10	N/A or Unfinished	HDL ADPT POSI TEMPT/S
114308	15.10	N/A or Unfinished	STEM EXT KIT, 7592 SERIES	116664	171.30	Chrome	SPT KIT, T6125 CHR
114311	9.25	N/A or Unfinished	SCREEN WSHR 7590 & 7592 SERIES	116665	290.00	Chrome	RT SPT KIT T920 SERIES CHR
114324	22.20	Chrome	HDL CAPS, HOT & COLD CHR	116671	72.90	Chrome	HDL HUB WTHL 2H LR LAV/ BAR COLD CHR
114331	20.90	Chrome	HDL HUB KGSY 2H LAV CHR 1	116673	94.60	Chrome	SIDE SPRAY ESC.
114332	16.10	Chrome	FRA MALE THRD KGSY 2.2 GPM CHR	116696	63.00	Chrome	HOSE ASSY 7FT
114334	18.10	Chrome	LIFT ROD KIT CHR	116698	29.50	N/A or Unfinished	ROMAN TUB HARDWARE KIT
114336	11.60	Chrome	LGE HDL NSRT CHR	116712	9.70	N/A or Unfinished	SHWR HD FLWR STRCTR 1.75 GPM (25)
114337	77.00	Chrome	HDL ASSY KGSY LR WS CHR	116713	53.75	Chrome	HDL KIT CHR
114343	17.80	N/A or Unfinished	HDL CAPS & SCR W CHR	116716	24.15	Chrome	HNDL KIT, H & C, CHR
114344	28.60	Chrome	HDL HUB, CHR	116719	38.95	N/A or Unfinished	CARTRIDGE 3F DVRTR
114346	31.35	Chrome	HDL ASSY KGSY THTS POSI CHR	116728	43.50	Chrome	HANDLE KIT, 87780, 87790
114384	7.95	N/A or Unfinished	RT RTNR CLIPS	116730	52.85	N/A or Unfinished	HARDWARE KIT
114385	20.35	N/A or Unfinished	BOTTLE, 16 OZ	116731	8.25	N/A or Unfinished	BEARING WASHER KIT
115000	33.65	N/A or Unfinished	HDL KIT 1HT/SCL	116953	48.45	Chrome	HDL KIT, HOT
				116954	48.45	Chrome	HDL KIT, COLD CHR
				117000	4.95	N/A or Unfinished	HDL H/C CHR
				117658	62.50	Chrome	SPT KIT CHR
				117659	12.90	Chrome	FRA FEMALE THRD 2.2GPM TRAD MORK CHR
				117660	43.90	Chrome	HDL KIT, 87440 & 87444

Moen Genuine Parts

Listed in numerical order

Part Number	List	Finish	Description
117947	32.75	Chrome	HDWR PACK HNDL LAV 1H LVR ADLER CHR
117948	43.20	Chrome	SHR LVR
118230	11.70	Chrome	HDL SLEEVE SERVICE KIT
118231	32.45	Chrome	HOT HDLE SERVICE KIT
118239	20.40	Chrome	FR MALE THRD 2.2GPM MTCL CHR
118240	10.60	Chrome	HDL CAP, 6102 CHR
118241	10.65	Chrome	HDL CAP W/ H & C 6102 CHR
118244	19.90	Chrome	LIFT ROD 6102 CHR
118245	11.75	N/A or Unfinished	HDWR KIT 6102
118297	13.55	N/A or Unfinished	HNDL HDWR KIT
118303	25.40	N/A or Unfinished	HDWR KIT, ABDN
118305	14.70	N/A or Unfinished	INSTALL KIT, ABDN
118306	4.65	N/A or Unfinished	INDICATORS, HOT & COLD
118882	21.70	Chrome	SINGLE MOUNT ESCUTCHEON, 6102
122556	6.70	N/A or Unfinished	O-RING KIT
122560	22.40	Chrome	STRM-F MALE THRD 2.2GPM WS LAV CHR
122566	16.60	N/A or Unfinished	HANDLE ADAPTER, POSI-TEMP
122569	17.40	N/A or Unfinished	HANDLE SCREW KIT, MOENTROL
123244	45.70	Chrome	DECK PLATE KIT CHR
123245	54.65	Chrome	DECK KIT WITH HOSE GUIDE
123247	104.20	Chrome	SPT TRAD BAR 2H CHR
123249	34.90	Chrome	HANDLE KIT, 1 HANDLE KITCHEN
123250	13.25	Chrome	DOVE, 1 HANDLE KITCHEN
123342	8.40	N/A or Unfinished	DECK GASKET, 2H KITCHEN
123663	8.70	N/A or Unfinished	DECK GASKET, 2H LAV
123799	13.95	Chrome	HANDLE CAP & SCREWS KIT
123804	29.15	Chrome	LIFT ROD KIT, WIDESPREAD
123807	19.50	Chrome	STREAM STRAIGHTENER KIT
124660	43.45	Chrome	SPOUT HUB, CHR
124662	81.15	N/A or Unfinished	HOSE KIT
124664	105.00	Chrome	WAND KIT, 7545, CHR
124665	9.85	N/A or Unfinished	BEARING WASHER, 7545
124737	41.00	Chrome	HANDLE KIT 1H KITCHEN
124738	92.05	Chrome	WAND KIT CHROME
124823	71.55	Chrome	SPOUT RECEPTOR CHR
124854	35.10	Chrome	HANDLE KIT 1H KITCHEN CHR
125752	40.05	Chrome	GRID DRAIN COVER, CHR
125753	100.75	Chrome	DIVERTER TUB SPOUT 1/2" CC
125754	46.65	Chrome	HANDLE KIT, POSI-TEMP
125756	98.00	Chrome	HANDLE KIT, WIDESPREAD LAV
125795	29.75	Chrome	CHT LEVER HANDLE RED/BLUE INDICATORS
125796	11.80	N/A or Unfinished	VESTIGES HEX WRENCH
125857	105.95	Chrome	SPT RCPT RLGD/TC KD P-OS CHR
125979	41.60	N/A or Unfinished	RED/BLUE INDICATORS (QTY 42)
125989	17.85	N/A or Unfinished	METAL HOSE WEIGHT
125999	6.95	N/A or Unfinished	HOT/COLD INDICATOR VSTG SHOWER
126956	20.20	Chrome	HOSE GUIDE KIT CHR
126964	12.90	Chrome	DOVE SERVICE KIT - CHR
126970	94.50	Chrome	SPT CHT KD 2H CHR
126971	38.95	Chrome	HANDLE SERVICE KIT - CHR
127683	47.55	N/A or Unfinished	FILTER MANIFOLD KIT
127685	54.85	N/A or Unfinished	FILTER MOUNTING BRACKET KIT
127686	8.35	N/A or Unfinished	BRACKET MOUNTING SCREW KIT
127689	15.55	N/A or Unfinished	SPOUT O-RING KIT
127690	7.95	N/A or Unfinished	FILTER AERATOR KIT
127691	16.05	N/A or Unfinished	DIVERTER KIT
128865	24.85	Chrome	LIFT ROD KIT CHR
128866	59.60	Chrome	HNDL ASSY H/C CHR
128867	61.00	Chrome	HNDL ASSY, HOT CHR
128868	61.00	Chrome	HNDL ASSY, COLD CHR

Part Number	List	Finish	Description
128869	8.35	N/A or Unfinished	DECK GSKT CHR
128870	56.80	Chrome	ESCT CHR
128871	55.40	Chrome	HNDL KIT CHR
128873	36.35	Chrome	LIFT ROD KIT CHR
128878	20.40	Chrome	AERATOR CHR
128879	132.65	Chrome	SPOUT KIT CHR
128880	75.10	Chrome	HNDL ASSY CHR
128883	189.00	Chrome	SPT KIT CHR
128884	22.45	Chrome	STREAM STRAIGHTENER CHR
128885	19.45	Chrome	LIFT ROD KIT CHR
128886	251.20	Chrome	SPOUT KIT CHR
129666	24.70	N/A or Unfinished	COLD ONLY SERVICE KIT
129706	29.45	N/A or Unfinished	TEMP RING KIT EVAWS
129707	28.25	N/A or Unfinished	TEMP RING KIT EVA CSET
129709	42.45	Chrome	LOOP HANDLE KIT
129830	400.10	Chrome	SPOUT KIT CHR
129831	6.75	N/A or Unfinished	BEARING WASHER KIT CHR
129908	46.90	Chrome	WAND 1H KD P-OS CHR BAG
130142	24.05	N/A or Unfinished	SPLINE ADAPTER & SCREW KIT
130143	80.10	N/A or Unfinished	THREAD ADAPTER & EXTENSION
130146	21.75	N/A or Unfinished	SPLINE ADAPTER & SCREW KIT
130147	9.25	Chrome	TEMPERATURE OVERRIDE KIT CHR
130148	55.30	Chrome	ESCUT ASSY T/S 1H DNPR BR SCHR
130149	120.90	Chrome	HANDLE KIT - VOLUME CONTROL
130150	26.20	Chrome	HANDLE CAP CHR
130151	122.20	Chrome	HANDLE KIT - THERMOSTATIC VALVE
130152	28.75	Chrome	HDL ESCT, SHORT CHR
130153	42.25	Chrome	HDL ESCT, TALL CHR
130155	27.45	Chrome	VOLUME CONTROL HANDLE EXTENSION KIT
130156	264.10	N/A or Unfinished	THERMOSTATIC CARTRIDGE REPLACEMENT KIT
130157	60.95	N/A or Unfinished	VOLUME CONTROL CARTRIDGE REPLACEMENT KIT
130158	20.20	N/A or Unfinished	CHECK STOP REPLACEMENT KIT
130525	89.80	Chrome	HDL, MTCL MWS 2H LVR COLD
130526	89.80	Chrome	HDL, MTCL MWS 2H LVR HOT
130965	55.30	Chrome	HANDLE HUB CHR
130966	13.55	Chrome	HINGE PIN CAP CHR
130967	27.70	Chrome	HINGE PIN ASSEMBLY
130968	45.50	Chrome	WALL ESCUTCHEON CHR
130969	32.10	Chrome	MOUNTING BRACKET
130970	25.25	Chrome	AERATOR ASSEMBLY CHR
130976	9.20	Chrome	HNDL CAP KIT CHR, 1H KD P-OS
130998	145.30	Chrome	LOW ARC SPOUT KIT CHR
131097	72.90	Chrome	HDL KIT - HOT CHR
131098	72.90	Chrome	HDL KIT - COLD CHR
131099	6.90	Chrome	HDL CAP CHR
131100	19.45	Chrome	LIFT ROD CHR
131101	84.15	Chrome	HDL KIT - HOT OR COLD CHR
131104	214.70	Chrome	SPT KIT CHR
131107	24.10	Chrome	LIFT ROD KIT CHR
131109	65.35	Chrome	SHR HDL KIT CHR
131191	144.85	Chrome	VOLUME CNTRL HDL KIT WTHL CHR
131195	146.20	Chrome	THERMOSTATIC HDL KIT WTHL CHR
131380	97.00	Chrome	PULLDOWN WAND CHR
131381	55.75	Chrome	PULLDOWN HOSE
131384	20.35	Chrome	DOVE CHR
132152	9.00	N/A or Unfinished	KIT SPOUT O-RING
132320	24.75	Chrome	TSTAT HDL CAP, SERVICE KIT, CHR
132596	44.10	N/A or Unfinished	FILTRATION CONNECTION HOSE KIT
132597	24.80	N/A or Unfinished	HARDWARE KIT

Moen Genuine Parts

Listed in numerical order

Part Number	List	Finish	Description	Part Number	List	Finish	Description
134122	538.70	Chrome	INFRARED SENSOR CONTROL BOX CHR	140379	90.70	Chrome	WAND CLND KD 1H P-OS CHR
134402	84.95	Chrome	HANDLE KIT CHR	140392	90.10	Chrome	WAND SLRAKD 1H P-OS CHR
134404	30.90	Chrome	BIDET LIFT ROD CHR	140706	10.15	N/A or Unfinished	MOUNTING HARDWARE
134742	105.70	Chrome	WAND KIT CHR	140708	12.20	N/A or Unfinished	MOUNTING WASHERS
135149	98.50	Chrome	3F ESCUTCHEON, NEUTRAL	140709	6.75	N/A or Unfinished	HOT/COLD HANDLE ADAPTERS
135150	33.75	Chrome	3F DIVERTER LEVER KIT, NEUTRAL CHR	140710	5.90	N/A or Unfinished	CARTRIDGE NUT KIT (2)
135151	10.80	Chrome	TOP TUBE W/O SCREW KIT 135152	140712	24.35	N/A or Unfinished	SHANK KIT
135152	5.65	N/A or Unfinished	DIVERTER HANDLE SPACER KIT	140713	27.70	N/A or Unfinished	QUICK CONNECT HOSE KIT - 4993
136101	29.30	N/A or Unfinished	HOSE ADAPTER	140714	19.50	N/A or Unfinished	CPVC TRANSITION FITTINGS (2) & CLIPS
136102	14.45	N/A or Unfinished	HOSE SPRAY KIT	140716	6.40	N/A or Unfinished	O-RING KIT (4)
136103	45.10	Black	HS KD, FEMALE BLK	140718	6.10	N/A or Unfinished	SHANK O-RING KIT
136104	87.65	Chrome	SIDE SPRAY, HOSE & HOSE GUIDE CHR	140719	38.90	N/A or Unfinished	QUICK CONNECT HOSE KIT - 9993
136106	90.30	Chrome	HOSE & SPRAY CHR	140720	28.45	N/A or Unfinished	HARDWARE KIT 9992/9993
136109	48.40	Black	SIDE SPRAY REPLACEMENT CHR	140721	9.30	N/A or Unfinished	QUICK CONNECT CLIPS (5)
136123	29.45	N/A or Unfinished	HDWSRVK KIT POSI STOP OVRMLD	140777	8.20	N/A or Unfinished	1.50 SHOWERING RESTRICTOR
136196	43.20	Chrome	ICON MOENTROL HANDLE AND ADAPTER KIT CHR	140779	8.20	N/A or Unfinished	2.0 SHOWERING RESTRICTOR
136197	7.55	Chrome	3F PLUG BUTTON AND SCREW KIT CHR	140899	8.05	N/A or Unfinished	SIDING WEDGE
136304	9.30	N/A or Unfinished	DVRTR KIT, 2H SHWR	140900	11.50	N/A or Unfinished	VACUUM BREAKER KIT
136331	10.30	N/A or Unfinished	SERVICE KIT, RT SPT PLUG SEAL	140901	7.35	N/A or Unfinished	TEMPERATURE INDICATOR
136640	55.20	Chrome	HDLKGSY3F KIT, CHR	140902	7.65	N/A or Unfinished	SILLCOCK TEMPERATURE LIMIT STOP
136829	64.90	Chrome	WAND EXTA 1H KD P-OS, CHR	140903	18.50	N/A or Unfinished	SILLCOCK HANDLE KIT
137001	12.30	N/A or Unfinished	SPOUT DOCKING COLLAR - ABERDEEN	140904	14.75	N/A or Unfinished	SILLCOCK RETAINING NUT
137028	51.85	N/A or Unfinished	HOSE KIT	140995	71.90	Chrome	WAND KIT CHR
137034	24.20	Chrome	SLIDER FOR SLIDEBAR	140997	13.65	Chrome	DOME KIT CHR
137035	11.45	N/A or Unfinished	SLIDEBAR MOUNTING HARDWARE KIT	140998	13.40	Chrome	CARTRIDGE NUT CHR
137388	79.15	Chrome	WS HANDLE KIT, HOT OR COLD, CHR	140999	6.85	Chrome	GASKET KIT
137390	173.55	Chrome	WS SPT KIT, CHR	141003	16.45	N/A or Unfinished	INSTALLATION TOOL KIT
137391	235.50	Chrome	RT SPT KIT, CHR	141006	41.60	Chrome	SIDE SPRY & HOSE ASSY CHR
137392	243.40	Chrome	ROMAN TUB DIVERTER SPOUT, CHR	141007	14.65	Chrome	HOSE GUIDE CHR
137393	25.80	Chrome	ROMAN TUB LIFT ROD, CHR	141008	23.75	Chrome	AERATOR AND RETAINER KIT, CHR
137394	74.00	Chrome	ESCT POSI 1H TS, CHR	141025	13.60	N/A or Unfinished	WAND SCREEN & O-RING KIT
137395	79.85	Chrome	ESCT MNT 1H TS, CHR	141044	116.95	Chrome	WAND & HOSE KIT CHR
137396	55.75	Chrome	HDL LR 1H TS, CHR	141797	38.90	Chrome	DOME KIT, CHR
137402	20.05	N/A or Unfinished	STRM-FASSY	141798	60.05	Chrome	ROMAN TUB ELBOW, CHR
137403	5.60	N/A or Unfinished	PLUG BUTTON KIT	141941	8.20	N/A or Unfinished	1.75 SHOWER FLOW RESTRICTOR (25 QTY)
137511	5.65	Chrome	HANDLE, LVR SERVICE KIT	142980	13.00	N/A or Unfinished	CHATEAU RT STEM EXT KIT
137512	8.05	N/A or Unfinished	HANDLE DOME SK	142981	6.70	N/A or Unfinished	ESCUTCHEON ADJUSTER KIT
137513	4.95	Chrome	CRTRG NUT CHR	143002	11.75	N/A or Unfinished	HANDLE ADAPTER
137514	13.40	Chrome	AERATOR CHR	143200	8.05	N/A or Unfinished	DECK GASKET & O-RING KIT
137515	1.40	Chrome	O-RING CHR	143321	32.45	Chrome	HANDLE KIT CH BRNTFRD
137516	11.60	Chrome	ESCT, CHR (6100)	143322	29.50	Chrome	HANDLE KIT CH EVA
137520	8.60	Chrome	AERATOR CHR	143323	29.10	Chrome	3H ESC CH BRNTFRD
137522	1.55	Chrome	SPT RNG CHR	143324	30.85	Chrome	3H ESC CH EVA
137526	4.65	Chrome	AERATOR CHR	143325	7.10	N/A or Unfinished	GASKET FOR 3H ESCT
137527	43.15	Chrome	HDL ASSY CHR	143327	7.55	N/A or Unfinished	MOUNTING SHANK
137532	12.70	Chrome	ESCT (T914) CHR	144266	6.45	N/A or Unfinished	CARTRIDGE NUT SERVICE KIT
137533	17.75	Chrome	LIFT ROD CHR	144450	17.40	Chrome	LEVER HANDLE KIT, COLD, CHR
137536	23.70	Chrome	HDL ASSY CHR	144451	17.40	Chrome	LEVER HANDLE KIT, HOT, CHR
137538	1.55	Chrome	PLUG BTN CHR	144454	21.40	Chrome	ESCUTCHEON KIT, CHROME
137540	51.85	Chrome	ESCT (T2701) CHR	144455	2.50	Chrome	GASKET CHR
138765	19.30	N/A or Unfinished	HDWR KIT, ABDN	146190	7.30	N/A or Unfinished	MOUNTING HARDWARE
139221	17.65	N/A or Unfinished	SOAP DISP PUMP ONLY SK	146194	4.45	N/A or Unfinished	CARTRIDGE NUT
139260	3.40	N/A or Unfinished	IO MOUNTING SCREWS	146210	35.75	Chrome	HANDLE KIT CHR
139769	40.60	Chrome	HANDLE ADAPTER	146211	14.75	Chrome	DOME CHR
139885	87.60	Chrome	HDL SRV KIT, THRMSTC DVRTR CHR	146213	6.30	N/A or Unfinished	O-RING
139968	64.55	N/A or Unfinished	HARDWARE KIT	146214	37.50	Chrome	HANDLE KIT CHR
140028	27.30	Chrome	SIDE SPRAY SERVICE KIT	146217	15.15	Chrome	DOME CHR
140251	16.20	Chrome	DECK GASKET & O-RING KIT	146220	41.10	Chrome	HANDLE KIT CHR
140325	39.85	N/A or Unfinished	SHANK & DIVERTER KIT 9992/9993	146221	83.70	Chrome	RECEPTOR CHR
				146670	6.80	Chrome	SLIDEBAR ESC CAP CHR
				146778	35.30	Chrome	ESCT 1H CHATEAU KD CHR
				146779	34.55	Chrome	ESCT 1H CHATEAU SPRAY IN DECK CHR
				146780	46.25	Chrome	HDL 1H CASTLEBY KD CHR
				146781	31.80	Chrome	HDL 1H CHATEAU KD CHR

Moen Genuine Parts

Listed in numerical order

Part Number	List	Finish	Description
146782	32.45	Chrome	HDL 1H LOOP CHATEAU KD CHR
146783	12.00	Chrome	1H KITCHEN DOME CHR
146784	197.70	Chrome	1H KITCHEN SPOUT CAMERIST CHR
146786	66.90	Chrome	1H KITCHEN SPOUT CHATEAU CHR
146787	7.70	N/A or Unfinished	BEARING WASHER CAMERIST 1H KITCHEN
146788	38.90	Chrome	SGL MT ESC CHATEAU KITCHEN CHR
146789	7.55	N/A or Unfinished	O-RING KIT, 1H KITCHEN
146790	16.15	N/A or Unfinished	MOUNTING HARDWARE 1H KITCHEN
146851	40.60	Chrome	HANDLE KIT, CHROME
146926	6.50	N/A or Unfinished	O-RING KIT, 1H KITCHEN
146927	11.65	N/A or Unfinished	MOUNTING HARDWARE 1H PULLOUTS
146928	33.85	Chrome	HANDLE KIT 1H KITCHEN CHR
146936	5.95	N/A or Unfinished	THIN DECK SPACER KIT
147207	32.50	N/A or Unfinished	SPLINE ADAPTER & SCREW KIT
147208	173.55	N/A or Unfinished	THERMOSTATIC CARTRIDGE REPLACEMENT KIT
147209	48.65	N/A or Unfinished	CHECK STOP REPLACEMENT KIT
147210	40.60	N/A or Unfinished	VOLUME CONTROL CARTRIDGE REPLACEMENT KIT
147211	24.30	N/A or Unfinished	SPLINE ADAPTER & SCREW KIT
147213	13.00	N/A or Unfinished	VOLUME CONTROL MOUNTING PLATE
147539	37.75	Chrome	KITCHEN ESCUTCHEON CHR
147540	12.00	Chrome	SPOUT SCREW CHR
147541	38.30	Chrome	HANDLE HUB CHR
147542	24.70	Chrome	HANDLE LEVER CHR
147543	238.90	Chrome	SPOUT CHR
147544	13.60	N/A or Unfinished	SPOUT O-RING CHR
147548	25.10	N/A or Unfinished	FILTER SCREEN FITTING 3/8"
147549	18.10	Chrome	LAV ESCUTCHEON CHR
147550	19.30	Chrome	LIFT ROD CHR
147552	38.30	Chrome	HANDLE HUB CHR
147554	11.30	Chrome	SLOT PLUG CHR
147555	46.25	Chrome	VESSEL EXT 5" CHR
147557	40.05	Chrome	HANDLE ASSY CHR
147558	9.30	N/A or Unfinished	HDWR PACK
147559	29.90	N/A or Unfinished	HANDLE IMPACT ASSY CHR
147562	12.30	Chrome	SPOUT ESCT CHR
147563	13.20	Chrome	HANDLE ESCT CHR
147564	29.10	Chrome	LIFT ROD CHR
147565	382.30	Chrome	ROMAN TUB SPOUT CHR
147566	36.25	Chrome	SPOUT ESCT CHR
147567	67.70	Chrome	HANDHELD ESCT CHR
147568	421.70	Chrome	ROMAN TUB SPOUT CHR
147569	49.80	Chrome	LIFT ROD CHR
147570	6.60	N/A or Unfinished	LIFT ROD BEARING CHR
147571	29.75	N/A or Unfinished	VESSEL EXT. STUD CHR
147573	36.00	Chrome	HANDLE KIT CHR
147574	71.05	Chrome	ESCT CHR
147575	6.45	N/A or Unfinished	HH ESCT SET SCREW & PLUG BTN CHR
147576	74.50	Chrome	ESCT CHR
148282	8.20	Chrome	1.75 FLOW RESTRICTOR
148478	6.50	Chrome	3FDVTR VLV PLASTER GROUND
148479	32.50	Chrome	3FDVTR VLV 1" EXT KIT
148480	32.50	Chrome	3FDVTR VLV ESCUT
148521	13.00	N/A or Unfinished	SUPPORT PLATE
148606	12.20	N/A or Unfinished	POSI CPVC ADPT SERVICE KIT
148820	32.50	Chrome	HANDLE KIT KD PULLDOWN CHR
148821	6.45	N/A or Unfinished	GASKET KIT KD
148974	3.65	Chrome	DECK GASKET, SOLIDAD
149088	9.50	N/A or Unfinished	DVRTR KIT
149111	36.00	Chrome	1H LAV HANDLE KIT CHR

Part Number	List	Finish	Description
149112	21.90	Chrome	1 HANDLE LAV LIFT ROD CHR
149113	55.70	Chrome	2H LAV HANDLE KIT CHR
149114	255.35	Chrome	SPT, WS CHR
149115	18.45	Chrome	LIFT ROD, WS CHR
149116	333.45	Chrome	3HOLE RT SPT CHR
149117	15.70	N/A or Unfinished	RT AERATOR
149118	361.30	Chrome	4H RT SPT CHR
149119	25.65	Chrome	LIFT ROD, RT CHR
149121	6.15	N/A or Unfinished	RED/BLUE HANDLE INDICATOR RINGS
149122	40.60	Chrome	POSI SHR HDL CHR
149123	66.85	Chrome	ESCT, POSI CHR
149381	9.80	N/A or Unfinished	MOENTROL PLASTER GROUND FOR 3F KIT
149509	45.20	Chrome	WAND KIT, CHR
149570	40.05	Chrome	HANDLE LEVER KIT, CHROME
149571	45.50	Chrome	ESCUTCHEON, CHROME
149748	16.00	Chrome	PLUG BUTTON KIT CHR
150036	26.00	Chrome	SCREW AND CAP KIT CHR
150259	41.30	N/A or Unfinished	HOSE KIT
150288	235.20	Chrome	SPOUT 1H KIT CHR
150313	10.60	N/A or Unfinished	INSTALLATION TOOL, 3/8" SQUARE
150625	29.20	Chrome	LVR HDL CHR
150626	29.75	Chrome	LVR HDL CHR
150628	8.75	Chrome	DOME CHR
150662	32.20	Chrome	HANDLE KIT CHR
150663	60.00	Chrome	ESCT BAR/KD 1 HNDL RING CHR
150665	45.45	Chrome	HANDLE KIT, 1 HANDLE BAR CHR
150666	12.20	Chrome	DOME, 1 HANDLE KITCHEN CHR
150667	45.45	Chrome	ESCT BAR/KD 1 HNDL RING CHR
150671	33.85	Chrome	HANDLE KIT, 1 HANDLE BAR CHR
150672	130.95	Chrome	SPOUT KIT 1H BAR
150883	4.50	N/A or Unfinished	COLOR INDICATORS
151189	36.05	Chrome	WAND KIT BAR/PREP CHR
151644	1.65	N/A or Unfinished	RED/BLUE 1H PLUG BUTTON MOD
151813	26.35	Chrome	3 HOLE LAV ESCT CHR
152859	5.90	Chrome	1255 PLUG BUTTON CHR
153206	9.25	Chrome	HANDLE DOME CHR
153641	60.00	Chrome	HNDL DOME WTHL 1H KD/ BAR CHR
153977	53.75	Chrome	PULLDOWN WAND CHR
153978	35.10	Chrome	HANDLE KIT KD PULLDOWN CHR
153983	5.40	N/A or Unfinished	GASKET KIT KD
154285	69.35	Chrome	HDL CAPS, ENGLISH & FRENCH
154286	204.20	Chrome	WEYMOUTH WS LAV SPT KIT
154287	24.15	Chrome	WEYMOUTH WS LIFT ROD KIT
154288	26.80	Chrome	WEYMOUTH LAVAER SHELL & INSERT
154290	257.60	Chrome	WEYMOUTH 3H RT SPT
154291	280.20	Chrome	WEYMOUTH 4H RT SPT
154292	16.85	Chrome	WEYMOUTH 4H RT LIFT ROD KIT
154293	446.20	Chrome	WEYMOUTH WLMT LAV SPT KIT
154294	29.30	Chrome	WEYMOUTH 1H LAV HDL KIT
154295	39.85	Chrome	WEYMOUTH RTAER SHELL & INSRT
154297	10.35	Chrome	TRAD SLIDE BAR END CAP CHR
154298	18.80	Chrome	WEYMOUTH EXT MP HDL INSRT CHR
154299	68.35	Chrome	WEYMOUTH EXT MP ESCT KIT CHR
154302	56.35	Chrome	WEYMOUTH POSI HDL KIT CHR
154306	16.85	Chrome	DIVERTER PLUG KIT CHR
155023	5.90	N/A or Unfinished	SINGLE HANDLE SET SCREW

Listed in numerical order

Part Number	List	Finish	Description
155649	50.00	Chrome	SQUARE ESCUTCHEON RING W/GASKET CHR
155650	44.55	Chrome	ROUND ESCUTCHEON RING W/GASKET CHR
155651	20.05	N/A or Unfinished	HOUSING NUT
155652	7.70	N/A or Unfinished	SET SCREW KIT
155654	5.30	N/A or Unfinished	O-RING KIT
155655	1.60	N/A or Unfinished	SCREEN FILTER
155658	17.85	N/A or Unfinished	SET SCREW, TEST PLUG & CAP KIT
155759	9.75	N/A or Unfinished	BRACKET SCREWS
156723	18.80	Chrome	CHATEAU KNOB HANDLE KIT, CHR
156724	54.15	Chrome	CHATEAU LEVER HANDLE KIT, CHR
157131	34.15	Chrome	ESCT POSI-TEMP CHR
157328	50.70	Chrome	ESCUTCHEON & GASKET KIT CHR
158080	17.30	Chrome	90 DEGREE WLM T SPT ESCT CHR
158376	41.45	Chrome	SHOWER ARM & FLANGE KIT CHR
158378	66.10	Chrome	TUB SPOUT KIT
158380	44.15	Chrome	HANDLE KIT CHR
158494	35.00	Chrome	ICON 1H HC HANDLE CHR
158495	40.10	Chrome	BRANTFORD 1H HC HANDLE CHR
158550	5.60	N/A or Unfinished	1.5GPM KITCHEN SCREEN KIT
159014	47.20	Chrome	ESCUTCHEON KIT ICON CHR
159018	84.95	Chrome	THERMOSTATIC HDL KIT ROTHBURY CHR
159019	84.80	Chrome	THERMOSTATIC HDL KIT 90 DEGREE CHR
159020	85.35	Chrome	VOLUME HDL KIT ICON CHR
159023	71.20	Chrome	ESCT KIT 90 DEGREE CHR
159024	84.50	Chrome	THERMOSTATIC HDL KIT ICON CHR
159028	85.70	Chrome	VOLUME HDL KIT 90 DEGREE CHR
159029	85.75	Chrome	VOLUME HDL KIT ROTHBURY CHR
159107	41.40	Chrome	HDL, MTCLS WS 2H HDL LAV & BDT CHR
159264	40.60	Chrome	3F DVTR VLV ESCUT, CHR
159266	42.15	Chrome	3F DVTR LEVER KIT, CHR
159299	0.50	N/A or Unfinished	O-RING KIT
159465	0.30	N/A or Unfinished	PLUNGER KIT
159466	0.05	N/A or Unfinished	CARTRIDGE NUT KIT
159467	1.40	N/A or Unfinished	2H DURALAST CARTRIDGE KIT
159559	15.85	N/A or Unfinished	PULLOUT KITCHEN WEIGHT
159560	40.10	N/A or Unfinished	PULLOUT KITCHEN HOSE
159561	63.80	Chrome	WAND KIT CHR
159582	20.25	N/A or Unfinished	TRANSFER HOSE KIT TC/SAE
160660	8.80	Chrome	HANDLE DOME KIT, CHR
161143	64.90	Chrome	WAND EXTA 1H KD P-OS, CHR 1.5GPM
161148	71.90	Chrome	WAND KIT CHR 1.5GPM
161149	105.70	Chrome	WAND KIT CHR 1.5GPM
161150	97.00	Chrome	PULLDOWN WAND CHR 1.5GPM
161153	43.65	Chrome	WAND KIT 1.5GPM
161156	62.70	Chrome	WAND KIT BAR/PREP CHR 1.5GPM
161157	53.75	Chrome	PULLDOWN WAND CHR 1.5GPM
161756	29.05	N/A or Unfinished	MOUNTING HARDWARE KIT
161757	8.75	N/A or Unfinished	CARTRIDGE NUTS (2)
161758	30.85	N/A or Unfinished	HOT/COLD STEM EXTENSIONS
161759	6.30	N/A or Unfinished	MUD CAPS (2)
161760	7.65	N/A or Unfinished	SPOUT SHANK CLIP
161761	44.00	N/A or Unfinished	ADJUSTABLE SPOUT SHANK
161762	28.40	N/A or Unfinished	MOUNTING BRACKETS KIT
161771	11.00	N/A or Unfinished	MOUNTING HARDWARE KIT
161772	40.90	N/A or Unfinished	ROMAN TUB DIVERTER KIT
161773	23.55	N/A or Unfinished	DIVERTER NUT REMOVAL TOOL

Part Number	List	Finish	Description
161774	11.55	N/A or Unfinished	HANDLE ADAPTER (2)
161909	33.35	Chrome	1H 1H HANDLE KIT CHR
161917	17.80	Chrome	1H 1H LIFT ROD CHR
161942	70.00	Chrome	WIDESPREAD HANDLE KIT CHR
161944	163.30	Chrome	WIDESPREAD SPOUT KIT CHR
161945	46.95	Chrome	CENTER SET HANDLE KIT CHR
161947	347.25	Chrome	NON DIVERTING RT SPOUT CHR
161949	379.40	Chrome	DIVERTING RT SPOUT CHR
161950	18.80	Chrome	ROMAN TUB LIFT ROD CHR
161952	54.25	Chrome	POSI SHOWERING ESCUTCHEON CHR
161953	40.60	Chrome	MOENTROL SHOWERING ESCUTCHEON CHR
161954	49.80	Chrome	SHOWERING HANDLE CHR
161956	7.55	Chrome	TEMP IND RINGS CHR
162105	13.00	N/A or Unfinished	NSRT KNB CHT LAV
162154	32.65	N/A or Unfinished	2F DIVERTER CARTRIDGE
162378	11.70	N/A or Unfinished	1.5 GPM KITCHEN CHECK VALVE
162379	11.70	N/A or Unfinished	1.5 GPM KITCHEN CHECK VALVE
163053	219.65	Chrome	WALL MOUNT SPOUT KIT, CHR
163138	46.95	Chrome	HANDLE KIT COLD CHR
163153	33.50	Chrome	TRANSFER VALVE ESCUTCHEON CH
163244	69.95	Chrome	1.5 GPM WAND KIT CHR
163245	202.05	Chrome	SPOUT KIT CHR
163247	66.25	Chrome	RECEPTOR KIT CHR
163248	70.00	Chrome	1.5 GPM WAND KIT CHR
163710	7.60	N/A or Unfinished	HOSE GUIDE
163711	14.55	N/A or Unfinished	BATTERY PACK
163714	236.65	N/A or Unfinished	ELECTRONICS BOX
163716	15.00	N/A or Unfinished	FILTER SCREEN HOSE
163717	15.10	N/A or Unfinished	FILTER SCREEN CONTROL BOX
163718	30.45	N/A or Unfinished	OUTLET HOSE
163792	4.30	Chrome	CAP, CHR
163793	5.15	N/A or Unfinished	HARDWARE KIT
163949	4.75	Chrome	RUBBER LIFT ROD PLUG BUTTON GREY
164486	14.35	Chrome	SIDESPRAY CHR
164487	29.90	Chrome	WEYMOUTH KITCHEN HANDLE KIT CHR
164488	47.70	Chrome	AERATOR SHELL AND INSERT CHR
165010	43.25	Chrome	HANDLE KIT CHR
165011	13.85	Chrome	HANDLE ESCT KIT CHR
165193	44.10	Chrome	WIDESPREAD HANDLE KIT CHR
165572	3.70	N/A or Unfinished	LIFT ROD GUIDE KIT
165901	42.30	Chrome	MOENTROL SHR ESCT R/B MARKINGS
165903	27.45	Chrome	1H1H HANDLE KIT CHR
165904	30.85	Chrome	1H1H HANDLE DOME KIT CHR
165905	59.15	Chrome	LAVATORY HANDLE KIT CHR
165906	301.40	Chrome	WIDESPREAD SPOUT KIT CHR
165907	6.40	N/A or Unfinished	TEMP INDICATOR RINGS
165908	270.50	Chrome	ROMAN TUB NON-DIVERTING TUB SPOUT CHR
165909	462.95	Chrome	ROMAN TUB DIVERTING TUB SPOUT CHR
165910	61.55	Chrome	ROMAN TUB LIFT ROD CHR
165913	40.60	Chrome	POSI-TEMP SHOWER HANDLE KIT CHR
165916	80.10	Chrome	THERMOSTATIC HANDLE KIT CHR
165917	79.60	Chrome	VOLUME CONTROL HANDLE KIT CHR
165922	24.40	Porcelain	PORCELAIN DIVERTER HANDLE CAP KIT CHR
165998	31.80	Chrome	WEYMOUTH KITCHEN SPOUT FINIAL
166471	2.60	N/A or Unfinished	S-SPOUT O-RING KIT
168492	106.00	Chrome	WAND KIT CHROME
168494	27.70	Chrome	HANDLE CHR

GENUINE PARTS

Moen Genuine Parts

Listed in numerical order

Part Number	List	Finish	Description
168495	170.60	Chrome	KITCHEN SPOUT CHR
168496	37.45	Chrome	SIDESPRAYKIT CHR
168497	109.90	Chrome	BAR SPOUT CHR
168498	6.45	N/A or Unfinished	GASKET
168499	9.50	Chrome	AERATOR KIT
168500	105.95	N/A or Unfinished	WAND KIT
168501	183.40	Chrome	SPOUT KIT CHR
168502	32.40	Chrome	HANDLE KIT CHR
168503	164.55	Chrome	SPOUT KIT CHR
168504	6.45	N/A or Unfinished	GASKET
168682	281.65	Chrome	WALL MOUNT SPOUT KIT
168683	82.45	Chrome	3/4 THERMOSTATIC SHOWER ESCUTCHEON
168994	7.20	N/A or Unfinished	O-RING KIT
169252	40.45	Chrome	ESCUTCHEON & GASKET KIT, CHR
169507	18.25	Chrome	AERATOR EXTENSION KIT
170145	396.65	Chrome	VESTIGE SPOUT KIT CHR
170190	54.50	Chrome	DIVERTER TUB SPOUT KIT, CHR
170206	7.35	N/A or Unfinished	DURALAST UPPER BEARING(CA) KIT
171325	9.70	N/A or Unfinished	SHROUD COVER KIT
172654	42.65	Chrome	SHOWER HANDLE KIT
172655	39.80	Chrome	TRANSFER TRIM ESCUTCHEON
172658	47.55	Chrome	ROMAN TUB LIFT ROD
172659	289.95	Chrome	4H ROMAN TUB SPOUT
172660	285.00	Chrome	3H ROMAN TUB SPOUT TUB KIT
172661	42.45	Chrome	WIDESPREAD LIFT ROD
172662	24.20	Chrome	WIDESPREAD SPOUT KIT
172663	55.90	Chrome	HANDLE KIT
172665	34.35	Chrome	SINGLE HOLE HANDLE KIT WITH RED/BLUE
172667	12.50	Chrome	SINGLE HANDLE LOW PROFILE LAV LIFT ROD K
172668	13.95	Chrome	SINGLE HANDLE SINGLE HOLE ESCUTCHEON KIT
172669	59.45	Chrome	MOENTROL SHOWER ESCUTCHEON KIT
173717	35.60	N/A or Unfinished	FILTER PLUG
173720	3.70	N/A or Unfinished	WAND SCREEN & O-RING KIT (1.5GPM)
173816	40.50	Chrome	WAND KIT CHR
173988	91.90	Chrome	WAND KIT CHR
174290	23.40	N/A or Unfinished	2H DURALAST STEM EXT. KIT
174291	46.95	N/A or Unfinished	DURALAST VALVE BODY KIT COLD
174292	46.95	N/A or Unfinished	DURALAST VALVE BODY KIT HOT
174329	10.35	N/A or Unfinished	HANDLE ADAPTER KIT
174333	51.85	Chrome	POSI ESCUTCHEON RED/BLUE
174836	5.40	N/A or Unfinished	DIVERTER RETAINER CLIP
175376	41.85	Chrome	HANDLE KIT CHR
175377	55.15	Chrome	ESCUTCHEON KIT CHR
175378	37.95	Chrome	LIFT ROD CHR
175379	54.40	Chrome	LEVER HANDLE KIT CHR
175380	69.20	Chrome	CROSS HANDLE KIT CHR
175381	178.50	Chrome	WIDESPREAD SPOUT KIT CHR
175382	343.30	Chrome	3H ROMAN TUB SPOUT CHR
175383	55.15	Chrome	ESCUTCHEON CHR
175394	79.60	N/A or Unfinished	PISTON, BULK KIT
175983	177.60	Chrome	KITCHEN SPOUT KIT CHR
175985	30.35	Chrome	KITCHEN HANDLE KIT CHR
175991	5.05	N/A or Unfinished	DECK GASKET
176077	94.00	Chrome	FLANGELESS SPOUT KIT 173888 CH
176078	104.35	Chrome	FLANGELESS SPOUT KIT 173890 CH
176079	100.90	Chrome	FLANGELESS SPOUT KIT 173892 CH
176081	107.35	Chrome	FLANGELESS SPOUT KIT 173895 CH

Part Number	List	Finish	Description
176086	108.65	Chrome	FLANGELESS SPOUT KIT 172905 CH
176101	29.00	Chrome	1H LAV HDL KIT, H/C IND, CHR
176261	74.70	Chrome	SPOUT KIT, BAR CHR
176633	38.30	Chrome	DIVERTER RING CHR
177049	25.40	N/A or Unfinished	O-RING KIT 4.5 X 1.78MM
177054	0.10	N/A or Unfinished	O-RING KIT 9.19 X 2.62MM
177056	0.15	N/A or Unfinished	O-RING KIT 18.72 X 2.62MM
177057	164.20	N/A or Unfinished	WASHER KIT (2000 per box)
177138	43.95	Chrome	HANDLE KIT HOT/COLD CHR
177167	43.20	Chrome	1H LAV ESCUTCHEON PLATE CHR
177567	17.80	N/A or Unfinished	BATTERY HOLDER & HARDWARE PACK
177568	126.85	N/A or Unfinished	ELECTRONICS BOX ONLY
177569	240.85	N/A or Unfinished	CONTROL BOX ONLY
177570	12.50	N/A or Unfinished	MOUNTING HARDWARE
177572	29.20	N/A or Unfinished	SUPPLY HOSE ASSEMBLY
177573	459.05	Chrome	SPOUT KIT, CH
177574	484.20	Chrome	SPOUT KIT, CH
177575	438.65	Chrome	SPOUT KIT, CH
177576	504.00	Chrome	SPOUT KIT, CH
177701	44.00	Chrome	KNOB, BDT DVRTR CHR
177702	39.10	Chrome	ESCUT, BDT DVRTR CHR
177703	302.15	N/A or Unfinished	DVTR VALVE, VCM BRKR
177705	68.65	N/A or Unfinished	SPRAY NOZZLE CHR
177706	16.50	N/A or Unfinished	CARTRIDGE NUT
178216	36.45	Chrome	1H KITCHEN HANDLE AND SET SCREW KIT CHR
178217	14.25	Chrome	1H KITCHEN HANDLE DOME KIT CHR
178218	95.70	Chrome	1H KITCHEN SPOUT KIT CHR
178219	40.55	Chrome	1H KITCHEN SPOUT HUB KIT CHR
178231	20.20	Chrome	2H KITCHEN SPOUT CAP CHR
178232	43.15	Chrome	2H KITCHEN HOT HANDLE KIT CHR
178233	86.80	Chrome	2H KITCHEN SPOUT HUB KIT CHR
178234	39.40	Chrome	ESCUTCHEON CHR
178294	39.65	N/A or Unfinished	BLACK STEM EXTENSION
178462	40.25	Chrome	LEVER HANDLE KIT CHR
178466	49.40	Chrome	3F TRANSFER VALVE HANDLE CHR
178467	81.80	Chrome	3F TRANSFER VALVE ESCUTCHEON KIT CHR
178888	209.40	Chrome	SPOUT KIT, CHR
178890	205.35	Chrome	SPOUT KIT, CHR
178892	225.95	Chrome	SPOUT KIT, CHR
178894	276.00	Chrome	SPOUT KIT, CHR
178896	290.55	Chrome	SPOUT KIT, CHR
179084	43.15	Chrome	2H KITCHEN COLD HANDLE KIT CHR
179085	100.55	Chrome	2H KITCHEN SPOUT KIT CHR
179086	55.85	Chrome	TRADITIONAL SIDE SPRAY/WPOI CHR
179100	34.25	Chrome	POSI HANDLE CHR
179354	221.95	Chrome	LIFT ROD KIT CHR
179572	98.25	N/A or Unfinished	DATA CABLE
179574	48.65	Chrome	WAND KIT CHR
179639	15.60	N/A or Unfinished	FILTER & O-RING KIT
179655	36.35	Chrome	HANDLE KIT, CHR
179656	53.65	Chrome	WAND KIT, CHR
179657	163.70	Chrome	RECEPTOR KIT, CHR
179675	20.05	Chrome	HANDLE KIT HOT, CHR
179781	17.85	Chrome	CS LIFT ROD KIT CHR
179782	52.85	Chrome	CENTERSET HANDLE KIT CHR
179783	25.10	N/A or Unfinished	GASKET
179784	67.50	Chrome	WIDESPREAD HANDLE KIT CHR
179785	262.40	Chrome	NON DIVERGING RT SPOUT CHR
179786	43.35	Chrome	WIDESPREAD LIFT ROD KIT CHR
179787	156.50	Chrome	WIDESPREAD SPOUT KIT CHR

Moen Genuine Parts

Listed in numerical order

Part Number	List	Finish	Description	Part Number	List	Finish	Description
179790	34.90	Chrome	ESCUTCHEON CHR	184085	146.05	Chrome	WIDESPREAD SPOUT KIT
179792	58.60	Chrome	HANDLE KIT CHR	184086	169.95	Chrome	ROMAN TUB SPOUT KIT CHR
179793	24.35	Chrome	SIDESPRAYHOSE GUIDE CHR	184450	39.65	Chrome	HNDLASSYKIT CHR
179827	30.65	Chrome	HANDLE KIT 1H CHR	184597	56.35	Chrome	HANDLE KIT, CHR
179828	8.30	Chrome	LIFT ROD CHR	184611	18.10	Chrome	HANDLE KIT, CHR
179830	39.25	Chrome	HANDLE KIT CHR	184613	17.75	Chrome	LIFT ROD KIT, CHR
179831	250.15	Chrome	SPOUT KIT CHR	185807	46.40	Chrome	1H HANDLE KIT CHR
179832	13.45	Chrome	HANDLE ADAPTER CHR	185808	18.15	Chrome	1H LIFT ROD KIT CHR
179833	14.60	Chrome	HANDLE ESCUTCHEON CHR	185809	9.05	N/A or Unfinished	O-RING
179836	46.85	Chrome	SHOWER ESCUTCHEON CHR	185810	46.45	Chrome	1H ESCUTCHEON CHR
179837	37.15	Chrome	SHOWER HANDLE KIT CHR	185811	43.75	Chrome	CS LEVER HANDLE KIT CHR
179877	9.60	N/A or Unfinished	BEARING WASHER & O-RING KIT	185812	19.35	Chrome	CS LIFT ROD KIT CHR
179878	6.00	N/A or Unfinished	DECK GASKET	185813	19.25	Chrome	WS SPOUT CAP CHR
179879	20.95	N/A or Unfinished	WATERWARY & O-RING KIT	185814	20.40	Chrome	LIFT ROD KIT CHR
180059	98.95	N/A or Unfinished	WAND KIT	185815	51.25	Chrome	HANDLE KIT CHR
180073	45.45	Chrome	DIVERTER LIFT ROD CHR	185816	163.40	Chrome	WS SPOUT KIT CHR
180157	9.05	N/A or Unfinished	AERATOR	185817	274.10	Chrome	3H RT SPOUT KIT CHR
180823	6.25	N/A or Unfinished	WASHER KIT	185818	254.65	Chrome	4H RT SPOUT KIT CHR
181007	13.75	N/A or Unfinished	AERATOR .5GPM	185819	23.85	Chrome	RT DIVERTER LIFT ROD KIT CHR
181066	7.45	Chrome	MALE THREAD 1.2GPM AERATOR	185821	36.20	Chrome	SHOWER HANDLE KIT CHR
181085	11.30	N/A or Unfinished	INSRT AERATOR FLOW RESTRICTOR 1.2 GPM	185823	31.90	Chrome	T VALVE ESCUTCHEON CHR
181089	43.65	Chrome	AERATOR ASM KIT	185834	33.45	Chrome	MOENTROLESCUTCHEON CHR
181106	67.35	Chrome	HANDLE KIT COLD, CHR	185910	38.15	N/A or Unfinished	AERATOR KIT 1.0GPM
181107	67.35	Chrome	HANDLE KIT HOT, CHR	186948	12.30	N/A or Unfinished	ANCHOR SERVICE KIT
181502	32.05	Chrome	3F DVTR VLVESCUT, CHR	187053	51.25	Chrome	MAGNETIX DOCKING CRADLE, CHR
181600	89.40	Chrome	3F DVTR LEVER KIT, CHR	187073	54.65	Chrome	INTEGRATED DECKPLATE CHR
181602	45.55	Chrome	3F DVTR LEVER KIT, CHR	187728	44.05	Chrome	WAND KIT CHR
181603	101.80	Chrome	3F DVTR LEVER KIT, CHR	187729	30.65	Chrome	HANDLE KIT CHR
181929	176.10	Chrome	SWING ARMAND COLLAR KIT	188029	28.40	Chrome	WAND KIT CHR
181930	92.25	Chrome	SPRING AND BEARING KIT	188030	29.45	Chrome	HANDLE KIT CHR
182074	442.05	Chrome	4H ROMAN TUB SPOUT CHR	188612	70.60	Chrome	CNOUT HUB KIT, CHR
182191	6.95	N/A or Unfinished	INSRT AERATOR FLOW RESTRICTOR 1.2 GPM	188613	104.20	Chrome	HANDLE KIT, HOT, CHR
182212	139.60	Chrome	BRANTFORD WS SPOUT KIT	188614	104.20	Chrome	HANDLE KIT, COLD, CHR
182213	135.45	Chrome	EVAWS SPOUT KIT CH	190102	48.10	Chrome	HANDLE KIT CHR
182244	42.35	Chrome	HANDLE KIT HOT/COLD, CHR	190112	40.10	Chrome	LIFT ROD CHR
182496	39.95	Chrome	HANDLE KIT HOT/COLD, CHR	190202	56.60	Chrome	LEVER HANDLE KIT CHR
182500	13.65	N/A or Unfinished	DURALAST HOT/COLD STEM EXT	190322	311.60	Chrome	RT SPOUT KIT CHR
182624	32.00	N/A or Unfinished	ELBOW ADAPTER W/O-RINGS	190330	35.35	Chrome	DECK PLATE KIT
182843	18.50	Chrome	LIFT ROD KIT, WIDESPREAD CH	190444	31.15	Chrome	POSI ESCUTCHEON CHR
182862	66.85	Chrome	POSI ESCUTCHEON RED/BLUE	190503	61.75	Chrome	SHOWER HANDLE KIT CHR
183245	14.25	N/A or Unfinished	AERATOR	190843	9.85	Chrome	AERATOR KIT
183296	68.25	Chrome	HANDLE KIT CHR	190844	21.40	Chrome	LIFT ROD KIT CHR
183297	104.65	Chrome	WAND KIT CHR	190845	42.10	Chrome	HANDLE LEVER KIT CHR
183298	36.90	Chrome	RECEPTOR KIT CHR	190846	58.85	Chrome	HANDLE KIT HOT CHR
183570	36.80	Chrome	SLIDER KIT FOR ANNEX	190847	58.85	Chrome	HANDLE KIT COLD CHR
183598	24.30	Chrome	HANDLE KIT CHR	190848	276.30	Chrome	WS SPOUT KIT CHR
183599	5.85	N/A or Unfinished	WEYMOUTH TUB FILLER SCREW KIT	190850	306.40	Chrome	3H RT SPOUT KIT CHR
183732	14.55	N/A or Unfinished	AERATOR 1.2 GPM KIT	190851	36.90	Chrome	DIVERTER LIFT ROD CHR
183810	54.35	Chrome	GENTA POSI HANDLE KIT CHR	190852	492.65	Chrome	4H RT SPOUT KIT CHR
183961	39.30	N/A or Unfinished	3/4" INLET NIPPLE, NUT & O-RING KIT	190853	45.85	Chrome	ESCUTCHEON CHR
183962	34.05	N/A or Unfinished	FILTER SCREEN, FILTER CAP & O-RING KIT	190854	48.50	Chrome	POSI/MOENTROL ESCUTCHEON CHR
183963	16.90	N/A or Unfinished	CONTROLLER MOUNTING HARDWARE KIT	190856	59.10	Chrome	2FTV ESCUTCHEON CHR
183964	37.15	N/A or Unfinished	1/2" INLET NIPPLE, NUT & O-RING KIT	190857	64.80	Chrome	3FTV ESCUTCHEON CHR
183965	38.85	N/A or Unfinished	1/2" OUTLET NIPPLE, NUT & O-RING KIT	190858	63.10	Chrome	HANDLE ESCUTCHEON KIT CHR
183966	130.35	N/A or Unfinished	DATA CABLE ADAPTERS KIT	190859	74.00	Chrome	POSI HANDLE KIT CHR
183969	19.20	N/A or Unfinished	CONTROLLER MTG BRACKET & HARDWARE KIT	190860	75.70	Chrome	MOENTROL HANDLE KIT CHR
183972	49.10	N/A or Unfinished	AC ADAPTER	190861	72.80	Chrome	2FTV HANDLE KIT CHR
184081	42.65	Chrome	1H HANDLE KIT	190862	68.35	Chrome	3FTV HANDLE KIT CHR
184082	11.60	N/A or Unfinished	1.0GPM AERATOR KIT	191000	193.45	Chrome	ARBOR WAVE FAUCET ASSEMBLY KIT CHR
184083	12.30	N/A or Unfinished	.5GPM AERATOR KIT	191001	201.50	Chrome	SLEEK WAVE FAUCET ASSEMBLY KIT CHR
184084	6.60	N/A or Unfinished	TEMP INDICATOR RING KIT	191002	266.15	Chrome	ALIGN SPRING WAVE FAUCET ASSEMBLY KIT CH
				191004	50.35	Chrome	ARBOR POWER BOOST WAND KIT CHR
				191005	48.90	Chrome	BRANTFORD POWER BOOST WAND KIT CHR

GENUINE PARTS

Moen Genuine Parts

Listed in numerical order

Part Number	List	Finish	Description
192155	9.75	N/A or Unfinished	MOUNTING HARDWARE KIT
192555	8.20	N/A or Unfinished	1.75 SHOWERING RESTRICTOR
192731	38.50	N/A or Unfinished	TOOL, RT DURALAST CARTRIDGE
192799	17.15	N/A or Unfinished	1" EXTENSION KIT
192842	20.25	N/A or Unfinished	HDWR PACK, MTG THIN WALL, POSI
192995	14.65	N/A or Unfinished	1" EXTENSION KIT
193089	74.20	Chrome	2FTVESCUTCHEON KIT, CH
193090	80.00	Chrome	POSI HANDLE KIT, CHR
193091	80.00	Chrome	MOENTROL HANDLE KIT,
193092	80.40	Chrome	2FT TRANSFER VALVE HANDLE KIT, CHR
193093	75.35	Chrome	3FT TRANSFER VALVE HANDLE KIT, CHR
193094	99.30	Chrome	SHOWER ESCUTCHEON KIT, CH
193095	69.95	Chrome	2FTVESCUTCHEON KIT, CH
193096	71.10	Chrome	3FTVESCUTCHEON KIT, CH
193097	59.25	Chrome	HANDLE HUB ESCUTCHEON KIT, CH
193098	63.45	Chrome	POSI HANDLE KIT, CHR
193099	65.90	Chrome	MOENTROL HANDLE KIT, CHR
193100	63.85	Chrome	2FT TRANSFER VALVE HANDLE KIT, CHR
193101	59.10	Chrome	3FT TRANSFER VALVE HANDLE KIT, CHR
193102	7.00	N/A or Unfinished	HANDLE HUB SCREW KIT
193103	29.20	N/A or Unfinished	MOUNTING HARDWARE KIT, POSI
193104	38.90	N/A or Unfinished	MOUNTING HARDWARE KIT, MOENTROL
193105	39.90	N/A or Unfinished	MOUNTING HARDWARE KIT, 2F
193112	20.70	N/A or Unfinished	HANDLE EXTENSION KIT, MOENTROL
193113	20.85	N/A or Unfinished	HANDLE EXTENSION KIT, 2F
193114	21.15	N/A or Unfinished	HANDLE EXTENSION KIT, POSI/3F
193115	11.75	N/A or Unfinished	STANDOFF SCREW KIT, MOENTROL
193116	12.65	N/A or Unfinished	STANDOFF SCREW KIT, 2F
193117	16.20	N/A or Unfinished	STANDOFF SCREW KIT, POSI & 3F
193163	30.00	N/A or Unfinished	MOUNTING HARDWARE KIT, 3F
193193	118.20	Chrome	DIVERter KIT CHR
193194	44.80	Chrome	DIVERter KNOB KIT CHR
193195	45.70	Chrome	HANDSHOWER CRADLE KIT CHR
193196	84.30	Chrome	HANDLE KIT CHR
193197	13.90	N/A or Unfinished	CARTRIDGE NUT
193244	83.40	Chrome	EXTMP ESCUTCHEON KIT ALIGN CHR
193245	73.25	Chrome	THERMOSTATIC HDL KIT ALIGN CHR
193246	74.05	Chrome	VOLUME HDL KIT ALIGN CHR
193247	71.85	Chrome	EXTMP ESCUTCHEON KIT BELFIELD CHR
193248	71.45	Chrome	THERMOSTATIC HDL KIT BELFIELD CHR
193249	72.25	Chrome	VOLUME HDL KIT BELFIELD CHR
193250	137.10	Chrome	EXTMP ESCUTCHEON KIT WYNFORD CHR
193251	74.15	Chrome	THERMOSTATIC HDL KIT WYNFORD CHR
193252	74.95	Chrome	VOLUME HDL KIT WYNFORD CHR
193253	92.60	Chrome	EXTMP ESCUTCHEON KIT VOSS CHR
193254	72.25	Chrome	THERMOSTATIC HDL KIT VOSS CHR
193255	73.05	Chrome	VOLUME HDL KIT VOSS CHR
193256	134.85	Chrome	EXTMP ESCUTCHEON KIT VIA CHR
193257	78.45	Chrome	THERMOSTATIC HDL KIT VIA CHR

Part Number	List	Finish	Description
193258	79.30	Chrome	VOLUME HDL KIT VIA CHR
193499	295.40	Chrome	BRANTFORD WAVE KIT CHR
193753	48.40	N/A or Unfinished	SEAMLESS POSI SHALLOW WALL KIT
193800	10.00	N/A or Unfinished	MOEN DISPOSAL SNAP RING AND SIMPLE SNAP
193900	19.35	N/A or Unfinished	MOEN DISPOSAL UNFINISHED FLANGE KIT
194149	32.45	N/A or Unfinished	2 FUNCTION DIVERter
194993	23.60	Chrome	VIA PROTRUDED AERATOR SHELL KIT, CH
194994	23.60	Chrome	RIZON PROTRUDED AERATOR SHELL KIT, CH
194995	23.60	Chrome	PROTRUDED AERATOR SHELL KIT, CH
195173	207.85	Chrome	SPOUT KIT CHROME
195345	68.50	Chrome	ET ESCUTCHEON KIT CHR
195346	94.10	Chrome	THERMOSTATIC HANDLE KIT CHR
195347	51.45	Chrome	ET SHORT RING ESC KIT CHR
195349	93.25	Chrome	VOLUME HANDLE KIT CHR
195356	28.05	Chrome	LEVER HANDLE - CHR
195357	67.20	Chrome	METAL WAND KIT - CHR
195358	39.95	Chrome	WHEEL HANDLE KIT - CHR
195359	78.20	Chrome	SPOUT KIT BAR
195360	58.50	Chrome	METAL BAR WAND KIT - CHR
195361	30.40	N/A or Unfinished	LARGE PULLDOWN HOSE WEIGHT
195362	4.70	Chrome	DECK GASKET CHR
195363	64.15	Chrome	KITCHEN PULLDOWN SPOUT KIT CHR
195365	15.70	Chrome	BAR PULLDOWN SPOUT KIT CHR
195366	6.85	Glacier	DECORATIVE HANDLE CAP
195367	33.05	Chrome	FINISHED HANDLE CAP CHR
195369	31.55	Chrome	LEVER HANDLE KIT CHR
195370	19.10	Chrome	KITCHEN PULLDOWN METAL WAND KIT CHR
195383	15.20	Chrome	BAR PULLDOWN METAL WAND KIT CHR
195709	55.40	Chrome	HAND SHOWER CRADLE CHR
195710	81.05	Chrome	HANDLE KIT CHR
195711	44.10	Chrome	DIVERter KNOB KIT CHR
195712	147.10	Chrome	DIVERter KIT CHR
195809	18.55	N/A or Unfinished	CARTRIDGE NUT
196252	65.00	Chrome	LEVER HANDLE KIT CHR
196253	80.15	Chrome	CROSS HANDLE KIT CHR
196267	46.45	Chrome	HANDLE KIT CHR
196268	181.95	Chrome	SPOUT KIT CHR
196270	386.50	Chrome	SPOUT KIT CHR
196271	324.85	Chrome	SPOUT KIT CHR
196445	52.15	Chrome	HANDSHOWER CRADLE KIT, CHR
196446	47.70	Chrome	HANDSHOWER CRADLE KIT, CHR
196447	55.45	Oil Rubbed Bronze	HANDSHOWER CRADLE KIT, CH
196448	46.50	Oil Rubbed Bronze	HANDSHOWER CRADLE KIT, CH
196449	71.65	Chrome	HANDLE KIT, CHR
196450	73.65	Chrome	HANDLE KIT, CHR
196451	81.95	Chrome	HANDLE KIT, CHR
196452	35.90	Chrome	DIVERter KNOB KIT, CHR
196453	146.20	Chrome	DIVERter KIT, CHR
196454	37.65	Chrome	DIVERter KNOB KIT, CHR
196455	147.10	Chrome	DIVERter KIT, CHR
196456	34.30	Chrome	DIVERter KNOB KIT, CHR
196457	159.00	Chrome	DIVERter KIT, CH
196458	36.85	Chrome	DIVERter KNOB KIT, CHR
196459	160.60	Chrome	DIVERter KIT, CH
197000	4.80	N/A or Unfinished	WLMTVLV MOUNTING SCREWS (3)
197001	37.00	N/A or Unfinished	ADJUSTABLE WLMT LAV SHANK KIT
197002	22.30	N/A or Unfinished	WLMT LAV HANDLE STEM EXTENSION KITS

Moen Genuine Parts

Listed in numerical order

Part Number	List	Finish	Description	Part Number	List	Finish	Description
197003	23.30	N/A or Unfinished	ADJUSTABLE WLMT LAV HANDLE ADAPTORS	198107	20.95	Chrome	TWOPIECE LIFT ROD KIT, CH
197004	18.00	N/A or Unfinished	CUTABLE WLMT VALVE STEM EXTENDERS	198172	17.75	N/A or Unfinished	DIVERTER STEM EXTENSION KIT
197171	16.75	N/A or Unfinished	FILTER KIT	198173	11.80	N/A or Unfinished	DIVERTER CLIP KIT
197584	22.45	Chrome	WS LIFT ROD KIT CH	198279	106.20	Chrome	WAND KIT CHR
197585	257.90	Chrome	WSSPOUT KIT	198280	108.10	Chrome	WAND KIT CHR
197586	61.35	Chrome	LEVER HANDLE KIT CH	198288	77.50	Chrome	SPOUT KIT CHR
197587	80.15	Chrome	CROSS HANDLE KIT CH	198289	23.45	Chrome	HANDLE KIT CHR
197588	310.85	Chrome	RT SPOUT KIT CH	198490	237.75	Chrome	ROMAN TUB SPOUT CHR
197590	318.85	Chrome	4H RT SPOUT KIT CH	198880	47.60	Chrome	2H KITCHEN H/C HANDLE CHR
197591	74.25	Chrome	SHOWER ESCUTCHEON KIT CH	198881	43.25	Chrome	ESC KIT CHR
197592	78.00	Chrome	POSI HANDLE KIT CH	198921	90.85	Chrome	WAND KIT, CHR
197593	79.35	Chrome	MOENTROL HANDLE KIT CH	198951	44.90	Chrome	POSI HANDLE KIT CHR
197594	94.35	Chrome	THERMOSTATIC HANDLE KIT CH	199097	84.75	Chrome	SPRING & BEARING KIT CH
197595	93.50	Chrome	VOLUME HANDLE KIT CH	199098	90.60	Chrome	SWING ARM & COLLAR KIT CH
197596	52.40	Chrome	2/3F TV ESCUTCHEON CH	199477	211.20	Chrome	NON DIVERTING RT SPOUT KIT CHR
197597	77.00	Chrome	2/3F TV HANDLE CH	199490	282.10	Chrome	ROMAN TUB SPOUT CH
197598	52.70	Chrome	3F TV ESCUTCHEON CH	199754	5.45	N/A or Unfinished	BRAKE AND TLS - POSI
197599	72.40	Chrome	3F TV HANDLE ASSEMBLY CH	200001	455.00	Chrome	ARRISSPOUT CHR
197600	62.85	Chrome	HANDSHOWER CRADLE KIT CH	200007	13.25	N/A or Unfinished	MANIFOLD MOUNTING HARDWARE
197601	79.40	Chrome	TUB FILLER HANDLE KIT CH	200008	85.20	N/A or Unfinished	SINGLE RISER MANIFOLD MOUNTING PLATE
197857	12.20	N/A or Unfinished	HARDWARE KIT	200009	69.45	N/A or Unfinished	DOUBLE RISER MANIFOLD MOUNTING PLATE
197869	331.40	Chrome	SPOUT KIT CHR	200010	124.80	N/A or Unfinished	SINGLE RISER BRACKET EXTENSION ARM
197870	342.65	Chrome	SPOUT KIT	200011	101.15	N/A or Unfinished	DOUBLE RISER BRACKET EXTENSION ARM
197872	35.60	Chrome	HANDLE KIT, CHR	200012	30.95	N/A or Unfinished	SINGLE RISER MUD COVER
197883	158.40	Chrome	SWING ARM AND DOCKING COLLAR KIT	200013	27.10	N/A or Unfinished	DOUBLE RISER MUD COVER
197884	75.75	Chrome	SPRING & DOCKING COLLAR CHR	200014	63.45	Chrome	WAND KIT CHR
197929	62.55	N/A or Unfinished	2 FUNCTION DIVERTER	200101	0.20	Chrome	PLUG BUTTON KIT, CHR
197930	32.45	N/A or Unfinished	3 FUNCTION DIVERTER	200711	20.15	Chrome	M-CORE DIVERTER BACKING PLATE KIT
197931	111.55	Chrome	ESCUTCHEON CHR	200712	8.45	Chrome	M-CORE DIVERTER SCREW KIT
197932	90.65	Chrome	ESCUTCHEON CHR	200713	8.30	Chrome	M-CORE DIVERTER HANDLE ADAPTOR KIT
197933	114.40	Chrome	ESCUTCHEON CHR	200714	27.80	Chrome	HANDLE KIT, CHR
197934	79.10	Chrome	ESCUTCHEON CHR	200715	31.40	Chrome	M-CORE DIVERTER ESCUTCHEON KIT, CHR
197935	85.75	Chrome	ESCUTCHEON CHR	200716	29.30	Chrome	HANDLE KIT, CHR
197936	90.35	Chrome	ESCUTCHEON CHR	200717	33.45	Chrome	M-CORE DIVERTER ESCUTCHEON KIT, CHR
197937	109.20	Chrome	ESCUTCHEON CHR	200718	30.60	Chrome	HANDLE KIT, CHR
197938	112.75	Chrome	ESCUTCHEON CHR	200719	33.45	Chrome	M-CORE DIVERTER ESCUTCHEON KIT, CHR
197939	112.65	Chrome	ESCUTCHEON CHR	200720	35.30	Chrome	HANDLE KIT, CHR
197940	112.65	Chrome	ESCUTCHEON CHR	200721	65.05	Chrome	M-CORE DIVERTER ESCUTCHEON KIT, CHR
197941	81.10	Chrome	ESCUTCHEON CHR	200722	27.70	Chrome	HANDLE KIT, CHR
197942	29.40	Chrome	HANDLE CHR	200723	30.45	Chrome	M-CORE DIVERTER ESCUTCHEON KIT, CHR
197943	25.85	Chrome	HANDLE CHR	200724	27.95	Chrome	HANDLE KIT, CHR
197944	28.50	Chrome	HANDLE CHR	200726	28.60	Chrome	HANDLE KIT, CHR
197945	28.05	Chrome	HANDLE CHR	200727	29.00	Chrome	M-CORE DIVERTER ESCUTCHEON KIT KIT, CHR
197946	29.05	Chrome	HANDLE CH	200728	27.50	Chrome	HANDLE KIT, CHR
197947	31.90	Chrome	HANDLE CHR	200729	28.60	Chrome	M-CORE DIVERTER ESCUTCHEON KIT KIT, CHR
197948	34.80	Chrome	HANDLE CHR	200730	21.25	Chrome	HANDLE KIT, CHR
197949	32.20	Chrome	HANDLE CHR	200731	24.45	Chrome	M-CORE DIVERTER ESCUTCHEON KIT KIT, CHR
197950	34.55	Chrome	HANDLE HUB CHR	200732	33.35	Chrome	HANDLE KIT, CHR
197951	30.15	Chrome	HANDLE CHR	200733	33.45	Chrome	M-CORE DIVERTER ESCUTCHEON KIT KIT, CHR
197952	27.50	Chrome	HANDLE CHR	200734	30.45	Chrome	HANDLE KIT, CHR
197953	18.45	Chrome	HANDLE ADAPTER KIT	200735	34.30	Chrome	M-CORE DIVERTER ESCUTCHEON KIT KIT, CHR
197954	15.95	Chrome	HANDLE ADAPTER KIT	200736	34.40	Chrome	HANDLE KIT, CHR
198018	35.75	Chrome	SLIDER CHR	200737	35.80	Chrome	M-CORE DIVERTER ESCUTCHEON KIT KIT, CHR
198019	8.65	Chrome	PLUG BUTTON CHR	200738	30.35	Chrome	HANDLE KIT, CHR
198027	32.35	Chrome	DIVERTER VALVE ESCUT, CHR	200739	29.55	Chrome	M-CORE DIVERTER ESCUTCHEON KIT KIT, CHR
198028	44.45	Chrome	DIVERTER VALVE ESCUT, CHR				
198029	50.70	Chrome	DIVERTER VALVE ESCUT, CHR				
198030	41.35	Chrome	DIVERTER VALVE ESCUT, CHR				
198031	48.00	Chrome	DIVERTER VALVE ESCUT, CHR				
198032	41.00	Chrome	DIVERTER VALVE ESCUT, CHR				
198033	42.25	Chrome	DIVERTER VALVE ESCUT, CHR				
198036	72.30	N/A or Unfinished	3F TV ESCUTCHEON KIT, CH				
198038	95.30	Chrome	SHOWER ESCUTCHEON KIT, CH				
198040	52.50	Chrome	HANDLE HUB ESCUTCHEON KIT, CH				

Moen Genuine Parts

Listed in numerical order

Part Number	List	Finish	Description	Part Number	List	Finish	Description
200740	29.00	Chrome	HANDLE KIT, CHR	200794	28.50	Chrome	M-CORE HANDLE KIT, CHR
200741	44.65	Chrome	M-CORE DIVERTER ESCUTCHEON KIT KIT, CHR	200795	45.85	Chrome	M-CORE ESCUTCHEON KIT, CHR
200742	31.50	Chrome	HANDLE KIT, CHR	200796	42.00	Chrome	M-CORE HANDLE KIT, CHR
200743	30.10	Chrome	M-CORE DIVERTER ESCUTCHEON KIT KIT, CHR	200797	62.00	Chrome	M-CORE ESCUTCHEON KIT, CHR
200744	27.50	Chrome	HANDLE KIT, CHR	200798	27.10	Chrome	M-CORE HANDLE KIT, CHR
200745	29.55	Chrome	M-CORE DIVERTER ESCUTCHEON KIT, CHR	200799	39.70	Chrome	M-CORE ESCUTCHEON KIT, CHR
200746	32.90	Chrome	HANDLE KIT, CHR	200800	27.60	Chrome	M-CORE HANDLE KIT, CHR
200747	28.40	Chrome	M-CORE DIVERTER ESCUTCHEON KIT KIT, CHR	200801	57.80	Chrome	M-CORE ESCUTCHEON KIT, CHR
200748	27.25	Chrome	HANDLE KIT, CHR	200802	30.60	Chrome	M-CORE HANDLE KIT, CHR
200749	29.30	Chrome	M-CORE DIVERTER ESCUTCHEON KIT, CHR	200803	62.00	Chrome	M-CORE ESCUTCHEON KIT, CHR
200750	29.00	Chrome	HANDLE KIT, CHR	200804	36.15	Chrome	M-CORE HANDLE KIT, CHR
200751	3.45	N/A or Unfinished	M-CORE FLUSH PLUG WITH NUT KIT	200805	80.80	Chrome	M-CORE ESCUTCHEON KIT, CHR
200752	7.25	N/A or Unfinished	M-CORE CONTROL PLASTER GROUND KIT	200806	33.65	Chrome	M-CORE HANDLE KIT, CHR
200753	9.70	N/A or Unfinished	M-CORE STACKED PLASTER GROUND KIT	200807	69.90	Chrome	M-CORE ESCUTCHEON KIT, CHR
200754	7.35	N/A or Unfinished	M-CORE DIVERTER PLASTER GROUND KIT	200808	31.85	Chrome	M-CORE ESCUTCHEON KIT, CHR
200757	9.70	N/A or Unfinished	M-CORE DIVERTER CARTRIDGE NUT KIT	200809	71.30	Chrome	M-CORE ESCUTCHEON KIT, CHR
200758	32.65	N/A or Unfinished	M-CORE DISCRETE DIVERTER CARTRIDGE KIT	200810	83.35	Chrome	M-CORE ESCUTCHEON KIT, CHR
200759	38.95	N/A or Unfinished	M-CORE SHARED DIVERTER CARTRIDGE KIT	200811	43.35	Chrome	M-CORE ESCUTCHEON KIT, CHR
200761	4.00	Chrome	M-CORE DIVERTER LIMIT AND CLIP	200812	87.15	Chrome	M-CORE ESCUTCHEON KIT, CHR
200762	17.15	N/A or Unfinished	M-CORE CARTRIDGE NUT KIT	200813	113.65	Chrome	M-CORE ESCUTCHEON KIT, CHR
200764	9.35	Chrome	M-CORE CONTROL VALVE HARDWARE KIT	200814	92.75	Chrome	M-CORE ESCUTCHEON KIT, CHR
200765	14.45	Chrome	M-CORE STACKED VALVE HARDWARE KIT	200815	136.20	Chrome	M-CORE ESCUTCHEON KIT, CHR
200766	22.30	Chrome	M-CORE CONTROL BACKING PLATE KIT, ROUND	200816	72.90	Chrome	M-CORE ESCUTCHEON KIT, CHR
200767	22.30	Chrome	M-CORE CONTROL BACKING PLATE KIT, SQUARE	200817	109.60	Chrome	M-CORE ESCUTCHEON KIT, CHR
200768	22.30	Chrome	M-CORE CONTROL BACKING PLATE KIT, VOSS	200818	41.65	Chrome	M-CORE ESCUTCHEON KIT, CHR
200769	33.25	Chrome	M-CORE STACKED BACKING PLATE KIT, ROUND	200819	68.80	Chrome	M-CORE ESCUTCHEON KIT, CHR
200770	33.25	Chrome	M-CORE STACKED BACKING PLATE KIT, SQUARE	200820	33.65	Chrome	M-CORE HANDLE HUB KIT, CHR
200771	33.25	Chrome	M-CORE STACKED BACKING PLATE KIT, VOSS	200821	34.05	Chrome	M-CORE HANDLE HUB KIT, CHR
200772	7.65	Chrome	M-CORE ROUND SNAPPING KIT	201203	66.85	Chrome	COLINET LVR HDL KIT CHR
200773	15.55	Chrome	M-CORE SQUARE SNAP RING KIT	201204	67.25	Chrome	COLINET CROSS HDL KIT CHR
200774	15.45	Chrome	M-CORE VOSS SNAPPING KIT	201205	220.25	Chrome	COLINET WLMT LAVSPT KIT CHR
200775	13.85	Chrome	M-CORE SLEEVE KIT, ROUND MODERN, CHR	201206	48.10	Chrome	WS LIFT ROD KIT CHR
200776	12.70	Chrome	M-CORE SLEEVE KIT, ROUND TRADITIONAL, CHR	201207	169.65	Chrome	WS SPOUT KIT CHR
200777	14.55	Chrome	M-CORE SLEEVE KIT, SQUARE, CHR	201208	420.15	Chrome	RT SPOUT KIT CHR
200778	14.55	Chrome	M-CORE SLEEVE KIT, VOSS, CHR	201209	455.65	Chrome	4HRT SPOUT KIT CHR
200782	25.85	Chrome	M-CORE HANDLE KIT, CHR	201211	97.75	Chrome	SHOWER ESCUTCHEON KIT CHR
200783	50.90	Chrome	M-CORE ESCUTCHEON KIT, CHR	201212	56.35	Chrome	POSI HANDLE KIT CHR
200784	41.00	Chrome	M-CORE HANDLE KIT, CHR	201213	99.10	Chrome	THERMOSTATIC HANDLE KIT CHR
200785	50.15	Chrome	M-CORE ESCUTCHEON KIT, CHR	201214	98.05	Chrome	VOLUME HANDLE KIT CHR
200786	29.10	Chrome	M-CORE HANDLE KIT, CHR	201215	88.60	Chrome	HANDSHOWER CRADLE KIT CHR
200787	33.95	Chrome	M-CORE ESCUTCHEON KIT, CHR	201216	83.75	Chrome	TUBFILLER HANDLE KIT CHR
200788	30.45	Chrome	M-CORE HANDLE KIT, CHR	201217	44.25	Chrome	DIVERTER KNOB KIT, CHR
200789	45.85	Chrome	M-CORE ESCUTCHEON KIT, CHR	201218	165.15	Chrome	DIVERTER KIT, CHR
200790	41.40	Chrome	M-CORE HANDLE KIT, CHR	201309	39.25	N/A or Unfinished	SMART FAUCET - BATTERY PACK/MOUNTING KIT
200791	28.60	Chrome	M-CORE HANDLE KIT, CHR	201310	7.85	N/A or Unfinished	U BY MOEN SMART FAUCET MOUNTING HRDW
200792	31.05	Chrome	M-CORE HANDLE KIT, CHR	201311	673.50	N/A or Unfinished	U BY MOEN SMART FAUCET CONTROL BOX
200793	62.10	Chrome	M-CORE ESCUTCHEON KIT, CHR	201899	38.70	Chrome	ESCUTCHEON KIT CHROME
				201900	32.90	Chrome	1H LAV HANDLE KIT CHROME
				201901	145.60	Chrome	2H WS SPOUT KIT CHROME
				201902	49.30	Chrome	2H WS HANDLE KIT CHROME
				201903	224.65	Chrome	3HRT SPOUT KIT CHROME

Moen Genuine Parts

Listed in numerical order

Part Number	List	Finish	Description	Part Number	List	Finish	Description
201905	69.60	Chrome	TF HANDLE KIT CHROME	210564	15.30	N/A or Unfinished	CARTRIDGE NUT KIT, SQ
201906	49.30	Chrome	TF HAND SHOWER CRADLE KIT CHROME	210565	20.20	N/A or Unfinished	CONTROL BACKING PLATE KIT, RND
201907	25.10	Chrome	TRANSFER VALVE HANDLE KIT CHROME	210566	20.20	N/A or Unfinished	CONTROL BACKING PLATE KIT, SQ
201908	28.20	Chrome	CONTROL HANDLE KIT CHROME	210567	20.20	N/A or Unfinished	CONTROL BACKING PLATE KIT, SOFT SQ
201909	70.15	Chrome	THERMOSTATIC HDL KIT CHROME	210568	13.30	N/A or Unfinished	SNAP RING KIT, RD
201910	70.00	Chrome	VOLUME HDL KIT CHROME	210569	13.30	N/A or Unfinished	SNAP RING KIT, SQ
201911	115.40	Chrome	TUB SPOUT KIT CHROME	210570	13.30	N/A or Unfinished	SNAP RING KIT, SOFT SQ
201912	43.15	Chrome	SHOWER HANDLE KIT CHROME	210571	1.10	N/A or Unfinished	TEST PLUG, WMTF
201913	10.70	Chrome	2HWS HDL ESCT KIT CHROME	210573	61.00	Chrome	WMTF EXT KIT, SQ, CH
201914	12.15	Chrome	2HWS SPOUT ESCT KIT CHROME	210574	60.70	Chrome	WMTF EXT KIT, SOFT SQ, CH
201915	12.15	Chrome	3H RT HDL ESCT KIT CHROME	210575	33.00	Chrome	90 DEG WMTF ESCUTCHEON KIT, CHR
201916	15.70	Chrome	3H RT SPOUT ESCT KIT CHROME	210576	32.10	Chrome	ALIGN WMTF ESCUTCHEON KIT, CHR
201992	323.70	Chrome	SPOUT KIT	210577	31.60	Chrome	TRADITIONAL WMTF ESCUTCHEON KIT, CHR
201993	43.50	Matte Black	WAND KIT	210578	31.90	Chrome	CIA WMTF ESCUTCHEON KIT, CHR
201994	47.35	Chrome	WAND KIT	210579	61.90	Chrome	COLINET WMTF ESCUTCHEON KIT, CHR
204687	24.80	Chrome	HANDLE KIT CH	210580	34.70	Chrome	DOUX WMTF ESCUTCHEON KIT, CHR
204688	26.15	Chrome	HANDLE HUB	210581	60.60	Chrome	FLARA WMTF ESCUTCHEON KIT, CHR
204772	152.70	Chrome	SPOUT, PULLDOWN	210582	33.50	Chrome	GENTA WMTF ESCUTCHEON KIT, CHR
204773	177.05	Chrome	SPOUT, BAR	210583	28.60	Chrome	GIBSON WMTF ESCUTCHEON KIT, CHR
204774	708.15	Chrome	U BY MOEN SPOUT	210584	33.10	Chrome	GLYDE WMTF ESCUTCHEON KIT, CHR
204775	73.85	Chrome	POWER BOOST WAND KIT	210585	35.10	Chrome	VOSS WMTF ESCUTCHEON KIT, CHR
204776	70.95	Chrome	WAND KIT	210586	6.80	N/A or Unfinished	WMTF PLASTER GROUND KIT
204777	69.05	Chrome	WAND KIT, BAR	210843	25.05	Chrome	M-CORE HANDLE KIT, CHR
204778	29.30	Chrome	HANDLE KIT, SIP	216711	8.25	N/A or Unfinished	NSRT AERATOR FLOW RESTRICTOR 1.5 GPM
204779	5.45	N/A or Unfinished	GASKET KIT	221641	86.00	Chrome	WEYMOUTH LVR HDL KIT CHR
205845	38.80	Chrome	HANDLE KIT CHR	221642	86.00	Chrome	WEYMOUTH CROSS HDL KIT CHR
205846	78.45	Chrome	WAND KIT CHR	222220	34.60	N/A or Unfinished	AC ADAPTER KIT
205847	50.90	Chrome	POWER BOOST WAND KIT CHR	252001	37.30	Chrome	HANDLE KIT, CHR
205848	475.20	Chrome	FAUCET ASSEMBLY KIT CHR	252002	36.55	Chrome	HANDSHOWER CRADLE KIT, CHR
205850	48.75	Chrome	HANDLE KIT CHR	252005	27.15	N/A or Unfinished	CARTRIDGE KIT, 1H
205883	17.30	N/A or Unfinished	DECK GASKET KIT	252006	51.30	N/A or Unfinished	CARTRIDGE SLEEVE
206288	25.65	Chrome	FINISHED H/C INDICATORS, CH	252007	54.45	N/A or Unfinished	CARTRIDGE NUT
206289	72.25	Chrome	ESCUTCHEON, CH	252008	182.70	N/A or Unfinished	SINGLE POST MOUNTING BRACKET
206290	24.95	Porcelain/Chrome	PORCELAIN H/C HANDLE CAP	252009	237.45	N/A or Unfinished	MANIFOLD W/STOPS, SINGLE RISER
206291	76.70	Chrome	ESCUTCHEON, CH	252010	146.50	Chrome	DIVERTER KIT CHR
206292	31.90	Chrome	HANDLE, CH	259416	151.60	Chrome	RISER ELBOW KIT, CH
206293	43.50	Chrome	ESCUTCHEON, CH	259417	61.45	N/A or Unfinished	MOUNTING SCREW KIT
206294	23.65	Chrome	HANDLE, CH	259418	47.85	N/A or Unfinished	LEVELING SCREW KIT
206295	48.80	Chrome	ESCUTCHEON, CH	259420	10.00	N/A or Unfinished	CONCRETE ROUGH IN SCREWS
206296	48.30	Chrome	ESCUTCHEON, CH	259421	196.90	N/A or Unfinished	SINGLE MANIFOLD MOUNTING BRACKET
206297	34.70	Chrome	HANDLE, CH	259422	198.75	N/A or Unfinished	DOUBLE MANIFOLD MOUNTING BRACKET
206301	40.50	Chrome	ESCUTCHEON, CH	259423	278.30	Chrome	RISER KIT, CH
206302	23.80	Chrome	HANDLE, CH	259424	6.10	N/A or Unfinished	O-RING KIT
206303	53.95	Chrome	ESCUTCHEON, CH	262000	126.90	Chrome	HANDLE KIT CROSS, CHR
206305	27.30	Chrome	HANDLE, CH	262001	39.15	Chrome	HANDLE KIT LEVER, CHR
206306	59.20	Chrome	ESCUTCHEON, CH	262002	58.60	Chrome	HANDLE HUB, CHR
206307	49.40	Chrome	ESCUTCHEON, CH	262003	90.00	N/A or Unfinished	HANDLE ADAPTOR KIT
206308	28.90	Chrome	HANDLE, CH	262004	63.35	Chrome	WALL ESCUTCHEON, CHR
206309	67.00	Chrome	ESCUTCHEON, CH	262005	322.45	Chrome	HANDSHOWER CRADLE, CHR
206320	42.15	Chrome	ESCUTCHEON, CH	262006	35.40	Chrome	ESCUTCHEON FLOOR, CHR
206321	25.10	Chrome	HANDLE, CH	262007	171.45	N/A or Unfinished	MANIFOLD W/STOPS, DOUBLE RISER
206322	51.85	Chrome	ESCUTCHEON, CH	262008	151.75	N/A or Unfinished	DOUBLE POST MOUNTING BRACKET
206323	28.10	Chrome	HANDLE, CH	262955	111.90	N/A or Unfinished	WALL MOUNT SHANKS
206324	62.70	Chrome	ESCUTCHEON, CH				
206325	81.75	Chrome	ESCUTCHEON, CH				
206327	28.10	Chrome	HANDLE, CH				
206328	67.00	Chrome	ESCUTCHEON, CH				
206329	28.10	Chrome	HANDLE, CH				
206330	67.00	Chrome	ESCUTCHEON, CH				
207669	14.00	N/A or Unfinished	M-CORE CARTRIDGE NUT KIT, BRASS				
209251	94.30	Satin Stainless	GRID KIT, FOR 216003 BUNDLE				
210492	55.40	Chrome	WMTF EXT KIT, ROUND MODERN, CH				
210563	11.60	N/A or Unfinished	CARTRIDGE NUT KIT, RND				

Moen Genuine Parts

Listed in numerical order

Part Number	List	Finish	Description
262956	1.50	N/A or Unfinished	HANDLE BRAKE KIT (BULK)
344111	21.05	Chrome	UNDER DECK PARTS (3942)
344112	89.15	Chrome	HEAD AND SPOUT KIT (3942) CHR
344113	21.05	Chrome	UNDER DECK PARTS (3944)
344114	89.15	Chrome	HEAD AND SPOUT KIT (3944) CHR
716711	8.20	N/A or Unfinished	AERATOR FLOW RESTRICTOR 1.5GPM
100005SLP	23.60	Brushed Platinum	ESCT PTCL KD 1H HOSE GUIDE SLP
100009SL	275.45	Stainless	SPTX CATH KD 1H SL
100011SL	43.80	Stainless	ESCT RNG KD 1H SGLMT SL
100012SL	64.55	Stainless	HDL MN/MTCL/PT KD 1H SOLID SL
100014SL	32.65	Stainless	HDL DOME LRG KD 1H SL
100021SLP	21.70	Brushed Platinum	HDL CAP CHT/MN KD 1H SLP
100021W	22.10	Glacier	HDL CAP CHT/MN KD 1H GLC
100024BN	19.75	Brushed Nickel	TL MNT TS 3F BN
100080BG	82.10	Brushed Gold	MOUNTING SLEEVE BG
100080BL	90.30	Black	MOUNTING SLEEVE BL
100080BN	82.10	Brushed Nickel	MOUNTING SLEEVE BN
100080NL	82.10	Polished Nickel	MOUNTING SLEEVE NL
100109WBL	14.75	N/A or Unfinished	HDW PACK KD 1H SOLID/ LOOP
100112P	45.60	Polished Brass	FRA MALE THRD MTCL LG 2.2 GPM PBCRD
100150BL	77.45	Matte Black	HDL LR NOVA LOOP BL
100150CSL	159.00	Classic Stainless	HDL LR NOVA LOOP CSL
100150SL	77.45	Stainless	HDL LR NOVA LOOP SL
100154SL	79.65	Stainless	HDL KIT, NOVA 1H KD, SL
100155SL	29.60	Stainless	HDL CAP, NOVA 1H KD, SL
100439W	17.80	Glacier	DOME CLND/EXTA/PT/ SALORA 1H KD LR GLC
100556BN	58.25	Brushed Nickel	HANDLE HUB & ELBOW BN
100558SL	66.90	Stainless	HDL, MTCL WS 2H LVR TS & KD SL
100621BC	80.85	Brushed Chrome	LEVER HDL KIT, BC, COLD
100621CBN	58.75	Classic Brushed Nickel	LEVER HDL KIT, CBN, COLD
100624BC	80.85	Brushed Chrome	LEVER HDL KIT, BC, HOT
100624CBN	58.75	Classic Brushed Nickel	LEVER HDL KIT, CBN, HOT
100649CBN	173.50	Classic Brushed Nickel	SPT, WS, CBN, SK
100650CBN	21.75	Classic Brushed Nickel	ESC, WS, CBN, SK
100657BC	35.60	Brushed Chrome	HDL TC POSI 1H TS LR BC
100746BG	31.80	Brushed Gold	HANDLE KIT BG
100746BL	87.25	Matte Black	SIP TRANSITIONAL HANDLE KIT
100746BLS	94.15	Black/Stainless Steel	HANDLE BLS
100746ORB	37.80	Oil Rubbed Bronze	SIP TRANSITIONAL HANDLE KIT ORB
100746SRS	31.80	Spot Resist Stainless	SIP TRANSITIONAL HANDLE KIT SRS
100820BG	105.00	Brushed Gold	SPOUT KIT BG
100820BL	83.55	Matte Black	SIP MODERN SPOUT KIT BL
100820BLS	115.45	Black/Stainless Steel	SPOUT KIT BLS
100820SRS	105.00	Spot Resist Stainless	SIP MODERN SPOUT KIT SRS
100895BG	36.45	Brushed Gold	HANDLE KIT BG
100895BL	159.55	Matte Black	SIP MODERN HANDLE KIT, BL
100895BLS	102.45	Black/Stainless Steel	HANDLE BLS
100895SRS	36.45	Spot Resist Stainless	SIP MODERN HANDLE KIT SRS
100896BG	116.45	Brushed Gold	SPOUT KIT BG
100896BL	56.10	Matte Black	SIP TRADITIONAL SPOUT KIT, BL
100896NL	184.15	Polished Nickel	SIP TRADITIONAL SPOUT KIT
100896ORB	143.10	Oil Rubbed Bronze	SIP TRADITIONAL SPOUT KIT ORB
100896SRS	116.45	Spot Resist Stainless	SIP TRADITIONAL SPOUT KIT SRS
100928BG	37.40	Brushed Gold	HANDLE KIT BG
100928BL	148.05	Matte Black	SIP TRADITIONAL HANDLE KIT, BL
100928NL	58.70	Polished Nickel	SIP TRADITIONAL HANDLE KIT
100928ORB	45.25	Oil Rubbed Bronze	SIP TRADITIONAL HANDLE KIT ORB
100928SRS	37.40	Spot Resist Stainless	SIP TRADITIONAL HANDLE KIT SRS

Part Number	List	Finish	Description
100957BG	31.70	Brushed Gold	SPOUT ESCUTCHEON BG
100957BL	73.10	Matte Black	SIP ESCUTCHEON W/LED INDICATOR, BL
100957BLS	43.45	Black/Stainless Steel	SPOUT ESCUT BLS
100957NL	41.40	Polished Nickel	SIP ESCUTCHEON W/LED INDICATOR
100957ORB	35.90	Oil Rubbed Bronze	SPOUT ESCUTCHEON W/LED INDICATOR ORB
100957SRS	31.70	Spot Resist Stainless	SPOUT ESCUTCHEON W/LED INDICATOR SRS
100961BG	183.90	Brushed Gold	SPOUT KIT BG
100961BL	46.10	Matte Black	SIP TRANSITIONAL SPOUT KIT, BL
100961BLS	269.90	Black/Stainless Steel	SPOUT KIT BLS
100961ORB	219.75	Oil Rubbed Bronze	SIP TRANSITIONAL SPOUT KIT ORB
100961SRS	183.90	Spot Resist Stainless	SIP TRANSITIONAL SPOUT KIT SRS
101010ORB	26.75	Oil Rubbed Bronze	MALE THREAD 1.5GPM AERATOR
101029ORB	30.55	Oil Rubbed Bronze	FEMALE THREAD 1.5GPM AERATOR
101029SRS	26.05	Spot Resist Stainless	AERATOR SRS 1.5GPM
101029WR	30.55	Wrought Iron	FEMALE THREAD 1.5GPM AERATOR
101077SRS	18.30	Spot Resist Stainless	AERATOR SRS 1.5GPM
101120ORB	35.85	Oil Rubbed Bronze	AERATOR KIT 1.5 GPM ORB
101120SRS	32.60	Spot Resist Stainless	AERATOR KIT 1.5GPM SRS
101140BN	52.50	Brushed Nickel	1H LAV HANDLE KIT, LEVER BN
101140NL	52.50	Polished Nickel	1H LAV HANDLE KIT, LEVER NL
101140ORB	57.75	Oil Rubbed Bronze	1H LAV HANDLE KIT, LEVER ORB
10116CBN	5.55	Classic Brushed Nickel	ESCT PLUG LAV CBN
101246SL	107.70	Stainless	SPT RCPTR LGD/TC KD P-OS SL
101249S	29.20	Sand	HDL COLLAR & NUT P-OS 1H KD SND
101249SL	27.55	Stainless	HDL COLLAR & NUT P-OS 1H KD SL
101249V	29.20	Ivory	HDL COLLAR & NUT P-OS 1H KD IVY
101249W	29.20	Glacier	DL COLLAR & NUT P-OS 1H KD GLC
101964BN	37.95	Brushed Nickel	FRA FEMALE THRD 2.2GPM BN
101964ORB	41.75	Oil Rubbed Bronze	FRA FEMALE THRD 2.2GPM ORB
101964SRS	16.60	Spot Resist Stainless	FRA FEMALE THRD 2.2GPM SRS
102562WR	24.75	Wrought Iron	ST TUBE VILT/SWR
103455BN	117.90	Brushed Nickel	SPRY NZZL SHRD & AER MTCL BDT BN
103455ORB	125.10	Oil Rubbed Bronze	SPRY NZZL SHRD & AER MTCL BDT ORB
104235ORB	30.75	Oil Rubbed Bronze	HOSE GUIDE
1047AMC	9.65	N/A or Unfinished	3 BOLT HUSH CUSHION
1055AMC	11.50	N/A or Unfinished	QUICK AND HOT TUBE KIT
114304CSL	64.95	Classic Stainless	HDL KIT 7590 SERIES CSL
114304ORB	92.60	Oil Rubbed Bronze	HDL KIT 7590 SERIES ORB
114304SL	64.95	Stainless	HDL KIT 7590 SERIES SL
114305CSL	25.35	Classic Stainless	HDL HUB 7590 SERIES CSL
114305ORB	45.20	Oil Rubbed Bronze	HDL HUB 7590 SERIES, ORB
114324BN	32.05	Brushed Nickel	TWO HANDLE LAV
114324ORB	35.10	Oil Rubbed Bronze	HDL CAPS, HOT & COLD ORB
114324W	5.15	Glacier/Chrome	HDL CAPS, HOT & COLD WHITE
114324WR	35.10	Wrought Iron	HDL CAPS, HOT & COLD WR
114331BN	29.55	Brushed Nickel	HDL HUB KGSY 2H LAV BN 1
114331ORB	32.50	Oil Rubbed Bronze	HDL HUB KGSY 2H LAV ORB 1
114331WR	32.50	Wrought Iron	HDL HUB KGSY 2H LAV WR 1
114332ORB	25.40	Oil Rubbed Bronze	FRA MALE THRD KGSY 2.2 GPM ORB
114334BN	26.35	Brushed Nickel	LIFT ROD KIT BN
114334ORB	28.05	Oil Rubbed Bronze	LIFT ROD KIT ORB
114334WR	28.05	Wrought Iron	LIFT ROD KIT WR
114336BG	24.15	Brushed Gold	HANDLE LEVER BG
114336NL	72.60	Polished Nickel	LEVER HANDLE

Moen Genuine Parts

Listed in numerical order

Part Number	List	Finish	Description	Part Number	List	Finish	Description
114336ORB	22.90	Oil Rubbed Bronze	LEVER HANDLE ORB	116673WR	150.90	Wrought Iron	SIDE SPRAY ESC.
114336SRS	24.15	Spot Resist Stainless	LEVER HANDLE SRS	116713BRB	96.20	Mediterranean Bronze	HDL KIT BRB
114337BN	111.80	Brushed Nickel	HDLASSYKGSYLRWSBN	116728ORB	69.15	Oil Rubbed Bronze	HANDLE KIT
114337ORB	122.95	Oil Rubbed Bronze	HDLASSYKGSYLRWSORB	116728SL	63.00	Stainless	HANDLE KIT, 87780SL, 87790SL
114337WR	122.95	Wrought Iron	HDLASSYKGSYLRWSWR	116953BN	74.50	Brushed Nickel	HDL KIT, HOT BN
114343BN	25.80	Brushed Nickel	HDL CAPS & SCRWB	116953ORB	81.95	Oil Rubbed Bronze	HDL KIT, HOT
114343ORB	28.40	Oil Rubbed Bronze	HDL CAPS & SCRWORB	116953WR	81.95	Wrought Iron	HDL KIT, HOT WR
114343WR	28.40	Wrought Iron	HDL CAPS & SCRWW	116954BN	74.50	Brushed Nickel	HDL KIT, COLD BN
114344BN	41.50	Brushed Nickel	HDL HUB, T3111, T3112, T3113 BN	116954ORB	81.95	Oil Rubbed Bronze	HDL KIT, COLD ORB
114344ORB	45.70	Oil Rubbed Bronze	HDL HUB, T3111, T3112, T3113 ORB	116954WR	81.95	Wrought Iron	HDL KIT, COLD WR
114346BN	45.65	Brushed Nickel	HDLASSYKGSYT 1HTS POSI BN	118239BN	29.55	Brushed Nickel	THRD 2.2GPM MTCL BN
114346NL	48.65	Polished Nickel	HDLASSYKGSY 1HTS POSI NL	118239WR	32.50	Wrought Iron	FRMALE THRD 2.2GPM MTCL WR
114346ORB	50.10	Oil Rubbed Bronze	HDLASSYKGSYT 1HTS POSI ORB	118243BN	13.60	Brushed Nickel	PLUG BUTTON 6102 BN
114346WR	50.10	Wrought Iron	HDLASSYKGSYT 1HTS POSI WR	118243ORB	14.90	Oil Rubbed Bronze	PLUG BUTTON, 6102 ORB
114348BG	167.25	Brushed Gold	HH SHR BRKT BG	118244BN	29.05	Brushed Nickel	LIFT ROD 6102 BN
115030SLP	30.70	Brushed Platinum	LVR HDL HOT 2H LAV & KD SLP	118244ORB	31.80	Oil Rubbed Bronze	LIFT ROD, 6102 ORB
115034BC	16.10	Brushed Chrome	HDL CAP KIT 2H LAV & KD	118244WR	31.80	Wrought Iron	LIFT ROD 6102 WR
115034BN	19.35	Brushed Nickel	HDL CAP KIT 2H LAV & KD BN	118882BN	32.45	Brushed Nickel	SINGLE MOUNT ESCUTCHEON, 6102 BN
115045SL	16.10	Stainless	FRA FEMALE THRD 2.2GPM BNBY 2H KD SL	118882ORB	35.60	Oil Rubbed Bronze	SINGLE MOUNT ESCUTCHEON, 6102 ORB
115055BN	18.50	Brushed Nickel	HDL CAP, SCRWB	118882WR	35.60	Wrought Iron	SINGLE MOUNT ESCUTCHEON, 6102 WR
115055CBN	9.80	Classic Brushed Nickel	HDL CAP, SCRWCBN	1193BN	72.55	Brushed Nickel	ESCT ASCR/CSBY/KGSY/VIL BDT BASE BN
115060SLP	32.00	Brushed Platinum	HDL CSBY KD/LAV 2H LVR COLD BOX SLP	1193NL	77.25	Polished Nickel	ESCT ASCR/CSBY/KGSY/VIL BDT BASE NL
115063BN	74.45	Brushed Nickel	LVR HDL, H & C BN	1193WR	79.85	Wrought Iron	ESCT ASCR/CSBY/KGSY/VIL BDT BASE WR
116606ORB	70.60	Oil Rubbed Bronze	ESCT, POSI SHR ORB	1225M	35.25	N/A or Unfinished	CRTGR MAGNUM WITH C-CLIP BULK
116618BN	27.70	Brushed Nickel	FRA FEMALE THRD 2.2GPM BN	123247CSL	151.20	Classic Stainless	SPT TRAD BAR 2H CSL
116618CSL	27.70	Classic Stainless	FRA FEMALE THRD 2.2GPM CSL	123247ORB	166.30	Oil Rubbed Bronze	BAR SPOUT KIT
116618ORB	30.55	Oil Rubbed Bronze	FRA FEMALE THRD 2.2GPM ORB	123247SRS	151.20	Spot Resist Stainless	BAR SPOUT KIT SRS
116618SRS	26.80	Spot Resist Stainless	AERATOR SRS	123250W	18.30	Glacier	DOMES, 1 HANDLE KITCHEN, GLC
116620NL	39.65	Polished Nickel	SPT HUB, 1H LAV NL	123804BL	34.15	Matte Black	LIFT ROD KIT, WIDESPREAD BL
116626ORB	116.15	Oil Rubbed Bronze	SPT KIT, WSLAV ORB	123804BN	44.80	Brushed Nickel	LIFT ROD KIT, WIDESPREAD BN
116628BN	24.30	Brushed Nickel	LVR HDL, WSLAV BN	123807BG	16.85	Brushed Gold	STREAM STRAIGHTNER BG
116628ORB	26.85	Oil Rubbed Bronze	LVR HDL, WSLAV ORB	123807BL	135.80	Matte Black	STREAM STRAIGHTNER KIT
116628WR	26.85	Wrought Iron	LVR HDL, WSLAV WR	123807BLS	18.85	Black/Stainless Steel	STREAM STRAIGHTNER KIT
116629BN	111.15	Brushed Nickel	HDL HUB, WSLAV BN	123807SRS	16.85	Spot Resist Stainless	STREAM STRAIGHTNER, SRS
116629ORB	120.55	Oil Rubbed Bronze	HDL HUB, WSLAV ORB	124660SRS	64.40	Spot Resist Stainless	SPOUT HUB KIT SRS
116629WR	120.55	Wrought Iron	HDL HUB, WSLAV WR	124664CSL	172.50	Classic Stainless	WAND KIT, 7545 CSL
116630BN	200.65	Brushed Nickel	SPT CAP, RT BN	124664ORB	184.20	Oil Rubbed Bronze	PULL-OUT WAND, ORB
116632NL	78.25	Polished Nickel	BODY AERATOR FEMALE THRD RMN TUB NLBK	124664SL	167.45	Stainless	WAND KIT, 7545, SL
116640WR	146.60	Wrought Iron	SPT KIT, 1HKD WR	124738CSL	60.50	Classic Stainless	WAND KIT CSL
116641ORB	132.85	Oil Rubbed Bronze	SPT KIT, 1HKD ORB	124738SL	141.45	Stainless	WAND KIT STAINLESS
116641WR	132.85	Wrought Iron	SPT KIT, 1HKD WR	124738W	128.65	Glacier	WAND KIT GLACIER
116648ORB	46.90	Oil Rubbed Bronze	LIFT ROD KIT, 2H LAV ORB	124823SL	110.25	Stainless	SPOUT RECEPTOR SL
116649ORB	50.85	Oil Rubbed Bronze	SPT CAP, 2H LAV ORB	124823W	100.30	Glacier	SPOUT RECEPTOR GLC
116664BN	248.35	Brushed Nickel	SPT KIT, T6125 BN	125752BN	61.05	Brushed Nickel	GRID DRAIN COVER BN
116664ORB	263.80	Oil Rubbed Bronze	SPT KIT, T6125 ORB	125754ORB	81.35	Oil Rubbed Bronze	HANDLE KIT, POSI-TEMP
116664WR	263.80	Wrought Iron	SPT KIT, T6125 WR	125756BN	152.15	Brushed Nickel	HANDLE KIT, WIDESPREAD LAV
116665BN	420.45	Brushed Nickel	RT SPT KIT T920 SERIES BN	125756ORB	167.25	Oil Rubbed Bronze	HANDLE KIT, WIDESPREAD LAV
116665ORB	446.55	Oil Rubbed Bronze	RT SPT KIT T9	12694BC	14.75	Brushed Chrome	LIFT ROD LAV MWS/ WS/1H/2H BC
116667ORB	28.75	Oil Rubbed Bronze	UPPER DVRTR ROD T922 SERIES ORB	12694BN	23.45	Brushed Nickel	CHATEAU 1H LIFT ROD BN
116670ORB	107.00	Oil Rubbed Bronze	HDL HUB WTHL 2H LRLAV/ BAR HOT ORB	126964W	49.45	Glacier	DOMES SERVICE KIT - GLC
116670SRS	97.40	Spot Resist Stainless	HDL HUB WTHL 2H LRLAV/ BAR HOT SRS	128865BN	38.35	Brushed Nickel	LIFT ROD KIT BN
116671ORB	107.00	Oil Rubbed Bronze	HDL HUB WTHL 2H LRLAV/ BAR ORB	128865ORB	42.35	Oil Rubbed Bronze	LIFT ROD KIT ORB
116671SRS	97.40	Spot Resist Stainless	HDL HUB WTHL 2H LRLAV/ BAR COLD SRS	128866BN	91.45	Brushed Nickel	HNDLASSY H/C BN
116672ORB	46.90	Oil Rubbed Bronze	HANDLE ESCUTCHEON, S713ORB ORB	128866ORB	100.65	Oil Rubbed Bronze	HNDLASSY H/C ORB
116672SRS	39.30	Spot Resist Stainless	HANDLE ESCUTCHEON, SRS	128867BN	93.45	Brushed Nickel	HNDLASSY, HOT BN
116672WR	46.90	Wrought Iron	HANDLE ESCUTCHEON, S713WR	128867ORB	102.95	Oil Rubbed Bronze	HNDLASSY, HOT ORB
116673ORB	150.90	Oil Rubbed Bronze	SIDE SPRAY ESC ORB	128868BN	93.45	Brushed Nickel	HNDLASSY, COLD BN
116673SRS	126.20	Spot Resist Stainless	SIDE SPRAY SRS	128868ORB	102.95	Oil Rubbed Bronze	HNDLASSY, COLD ORB
				128870BN	84.20	Brushed Nickel	ESCT BN
				128870ORB	92.65	Oil Rubbed Bronze	ESCT ORB

Moen Genuine Parts

Listed in numerical order

Part Number	List	Finish	Description
128871BN	85.45	Brushed Nickel	HNDL KIT BN
128871ORB	94.05	Oil Rubbed Bronze	HNDL KIT ORB
128873BN	54.10	Brushed Nickel	LIFT ROD KIT BN
128873ORB	59.50	Oil Rubbed Bronze	LIFT ROD KIT ORB
128879BN	211.75	Brushed Nickel	SPOUT KIT BN
128880BN	111.35	Brushed Nickel	HNDLASSYBN
128883BN	273.90	Brushed Nickel	SPT KIT BN
128885BN	28.65	Brushed Nickel	LIFT ROD KIT BN
128886BN	364.20	Brushed Nickel	SPOUT KIT BN
130147BG	14.90	Brushed Gold	VERRIDE SCREW KIT BG
130147BN	14.90	Brushed Nickel	TEMPERATURE OVERRIDE KIT BN
130147NL	15.40	Polished Nickel	TEMPERATURE OVERRIDE KIT NL
130147ORB	16.45	Oil Rubbed Bronze	TEMPERATURE OVERRIDE KIT ORB
130147WR	16.45	Wrought Iron	TEMPERATURE OVERRIDE KIT WR
130148BN	118.75	Brushed Nickel	ESCUT ASSYT/SH DNPR BRS BN
130148ORB	130.55	Oil Rubbed Bronze	ESCUT ASSYT/SH DNPR BRS ORB
130149BN	186.25	Brushed Nickel	HANDLE KIT - VOLUME CONTROL
130149ORB	204.85	Oil Rubbed Bronze	HANDLE KIT - VOLUME CONTROL
130150BG	38.70	Brushed Gold	VOLUME HANDLE CAP KIT BG
130150BN	38.70	Brushed Nickel	HANDLE CAP
130150NL	40.10	Polished Nickel	HANDLE CAP NL
130150ORB	42.70	Oil Rubbed Bronze	HANDLE CAP
130150WR	42.70	Wrought Iron	HANDLE CAP
130151BN	188.20	Brushed Nickel	HANDLE KIT - THERMOSTATIC VALVE
130151NL	92.65	Polished Nickel	3/4" THERMOSTATIC HDL KIT NL
130151ORB	207.05	Oil Rubbed Bronze	HANDLE KIT - THERMOSTATIC VALVE
130152BG	57.80	Brushed Gold	SHORT RING ESCUTCHEON KIT BG
130152BN	57.80	Brushed Nickel	SHORT HANDLE ESCUTCHEON
130152NL	48.40	Polished Nickel	HDL ESCT, SHORT NL
130152ORB	63.55	Oil Rubbed Bronze	SHORT HANDLE ESCUTCHEON
130152WR	63.55	Wrought Iron	SHORT HANDLE ESCUTCHEON
130965BG	66.55	Brushed Gold	HANDLE KIT BG
130965BL	23.10	Matte Black	HANDLE HUB BL
130965NL	66.55	Polished Nickel	HANDLE HUB
130965ORB	107.80	Oil Rubbed Bronze	HANDLE HUB ORB
130965SRS	66.55	Spot Resist Stainless	HANDLE HUB SRS
130966BG	14.75	Brushed Gold	HINGE CAP BG
130966BL	52.15	Matte Black	HINGE PIN CAP BL
130966BLS	38.60	Black/Stainless Steel	HINGE PIN CAP BLS
130966NL	61.15	Polished Nickel	HINGE PIN CAP
130966ORB	13.60	Oil Rubbed Bronze	HINGE PIN CAP ORB
130966SRS	14.75	Spot Resist Stainless	HINGE PIN CAP SRS
130968BG	60.60	Brushed Gold	ESCUTCHEON BG
130968BL	66.65	Matte Black	WALL ESCUTCHEON BL
130968NL	92.20	Polished Nickel	WALL ESCUTCHEON
130968ORB	49.50	Oil Rubbed Bronze	WALL ESCUTCHEON ORB
130968SRS	60.60	Spot Resist Stainless	WALL ESCUTCHEON SRS
130970BG	25.15	Brushed Gold	STREAM STRAIGHTNER BG
130970BL	138.05	Matte Black	AERATOR ASSEMBLY BL
130970NL	52.20	Polished Nickel	AERATOR ASSEMBLY
130970ORB	27.50	Oil Rubbed Bronze	STREAM STRAIGHTNER ORB
130970SRS	25.15	Spot Resist Stainless	STREAM STRAIGHTNER SRS
130976CSL	26.30	Classic Stainless	HNDL CAP KIT CHR, 1H KD CSL
130976SL	26.30	Stainless	HNDL CAP KIT SL, 1H KD P-OS
130998BN	223.65	Brushed Nickel	LOW ARC SPOUT KIT BN
131097BN	106.00	Brushed Nickel	HDL KIT - HOT BN
131097ORB	116.55	Oil Rubbed Bronze	HDL KIT - HOT ORB
131098BN	106.00	Brushed Nickel	HDL KIT - COLD BN
131098ORB	116.55	Oil Rubbed Bronze	HDL KIT - COLD ORB
131099BN	10.10	Brushed Nickel	HDL CAP BN

Part Number	List	Finish	Description
131099ORB	11.20	Oil Rubbed Bronze	HDL CAP ORB
131100BN	28.05	Brushed Nickel	LIFT ROD BN
131100NL	62.40	Polished Nickel	LIFT ROD KIT NL
131100ORB	30.85	Oil Rubbed Bronze	LIFT ROD ORB
131101BN	122.15	Brushed Nickel	HDL KIT - HOT OR COLD BN
131101ORB	134.25	Oil Rubbed Bronze	HDL KIT - HOT OR COLD ORB
131107BN	34.90	Brushed Nickel	LIFT ROD KIT BN
131107ORB	38.30	Oil Rubbed Bronze	LIFT ROD KIT ORB
131109BN	94.85	Brushed Nickel	SHR HDL KIT BN
131109ORB	104.25	Oil Rubbed Bronze	SHR HDL KIT ORB
131191BG	223.00	Brushed Gold	VOLUME HANDLE KIT BG
131191BN	223.00	Brushed Nickel	VOLUME CNTRL HDL KIT WTHL BN
131191NL	223.00	Polished Nickel	VOLUME CNTRL HDL KIT WTHL NL
131191ORB	245.20	Oil Rubbed Bronze	VOLUME CNTRL HDL KIT WTHL ORB
131191WR	245.20	Wrought Iron	VOLUME CNTRL HDL KIT WTHL WR
131195BG	224.80	Brushed Gold	THERMOSTATIC HANDLE KIT BG
131195BN	224.80	Brushed Nickel	THERMOSTATIC HDL KIT WTHL BN
131195NL	224.80	Polished Nickel	THERMOSTATIC HDL KIT WTHL NL
131195ORB	247.30	Oil Rubbed Bronze	THERMOSTATIC HDL KIT WTHL ORB
131195WR	247.30	Wrought Iron	THERMOSTATIC HDL KIT WTHL WR
131380BL	95.60	Matte Black	PULLDOWN WAND BL
131380CSL	117.30	Classic Stainless	PULLDOWN WAND CSL
131380ORB	120.55	Oil Rubbed Bronze	PULLDOWN WAND ORB
131380SL	114.00	Stainless	PULLDOWN WAND SL
131380SRS	44.50	Spot Resist Stainless	PULLDOWN WAND SRS
132320BG	41.80	Brushed Gold	THERMOSTATIC HANDLE CAP BG
132320BN	41.80	Brushed Nickel	TSTAT HDL CAP, SERVICE KIT, BN
132320ORB	46.05	Oil Rubbed Bronze	TSTAT HDL CAP, SERVICE KIT, ORB
132448BG	22.20	Brushed Gold	ADJUSTABLE TEMPERATURE LIMIT STOP BG
133022BN	20.90	Brushed Nickel	WS LIFT ROD ASSY KIT BN
133025BN	69.10	Brushed Nickel	TUB SPOUT ASSY KIT BN
134402BN	139.05	Brushed Nickel	HANDLE KIT BN
134404BN	74.35	Brushed Nickel	BIDET LIFT ROD BN
134404ORB	74.35	Oil Rubbed Bronze	BIDET LIFT ROD ORB
134413CSL	61.15	Classic Stainless	HDL ESCT KIT CSL
134413SL	61.95	Stainless	HDL ESCT KIT SL
134418CSL	69.00	Classic Stainless	SPT ESCT CSL
134418SL	69.00	Stainless	SPT ESCT SL
134742CSL	130.95	Classic Stainless	WAND KIT CSL
134742ORB	137.50	Oil Rubbed Bronze	WAND KIT ORB
134742SL	130.95	Stainless	WAND KIT SL
134742SRS	126.60	Spot Resist Stainless	WAND KIT SRS 2.2GPM
134938ORB	96.75	Oil Rubbed Bronze	VESTIGE LEVER HANDLE KIT, ORB
135149BN	138.25	Brushed Nickel	3F ESCUTCHEON KIT, NEUTRAL, BN
135149NL	138.00	Polished Nickel	3F ESCUTCHEON KIT, NEUTRAL, NL
135149ORB	164.50	Oil Rubbed Bronze	3F ESCUTCHEON KIT, NEUTRAL, ORB
135149WR	164.50	Wrought Iron	3F ESCUTCHEON KIT, NEUTRAL, WR
135150BN	54.85	Brushed Nickel	3F DIVERTER LEVER KIT, NEUTRAL, BN
135150ORB	60.45	Oil Rubbed Bronze	3F DIVERTER LEVER KIT, NEUTRAL, ORB
135150WR	60.45	Wrought Iron	3F DIVERTER LEVER KIT, NEUTRAL, WR
135151BG	15.85	Brushed Gold	STOP TUBE KIT W/O SCREW BG
135151BL	17.25	Matte Black	STOP TUBE W/O SCREW KIT, BL
135151BN	15.85	Brushed Nickel	STOP TUBE W/O SCREW KIT, BN

Listed in numerical order

Part Number	List	Finish	Description
135151WR	17.25	Wrought Iron	STOPTUBE/WO SCREW KIT, WR
136103C	45.10	Chrome	SPRAYHEAD & HOSE ASSY CHR
136103ORB	104.55	Oil Rubbed Bronze	HSKD, FEMALE ORB
136103SL	62.40	Stainless	SPRAYHEAD & HOSE ASSY SL
136103SLP	62.40	Brushed Platinum	SPRAYHEAD & HOSE ASSY SLP
136103V	45.10	Ivory	SPRAYHEAD & HOSE ASSY IVY
136103W	45.10	Glacier	SPRAYHEAD & HOSE ASSY GLC
136104CSL	149.75	Classic Stainless	WTHLSS HD, HOSE & HOSE GUIDE CSL
136104ORB	164.70	Oil Rubbed Bronze	WTHLSS HD, HOSE & HOSE GUIDE ORB
136104SRS	253.95	Spot Resist Stainless	SIDESPRAY AND HOSE SRS
136104WR	164.70	Wrought Iron	SIDE SPRAY, HOSE & HOSE GUIDE WR
136106CSL	90.30	Classic Stainless	HOSE & SPRAY CSL
136106ORB	109.15	Oil Rubbed Bronze	HOSE & SPRAY ORB
136106SL	90.30	Stainless	HOSE & SPRAY SL
136106SRS	90.30	Spot Resist Stainless	SIDE SPRAYS SRS
136197BN	19.10	Brushed Nickel	3F PLUG BUTTON AND SCREW KIT, BN
136197NL	11.05	Polished Nickel	3F PLUG BUTTON AND SCREW KIT NL
136197ORB	20.85	Oil Rubbed Bronze	3F PLUG BUTTON AND SCREW KIT, ORB
136197WR	20.85	Wrought Iron	3F PLUG BUTTON AND SCREW KIT WR
136640BN	74.15	Brushed Nickel	HDL KGSY3F KIT, BN
136640ORB	81.65	Oil Rubbed Bronze	HDL KGSY3F KIT, ORB
136829BL	62.15	Matte Black	WAND EXTA 1H KD P-OS, BL
136829SL	78.25	Stainless	WAND EXTA 1H KD P-OS, SL
136829V	62.15	Ivory	WAND EXTA 1H KD P-OS, V
136829WG	62.15	Glacier/Pebble	WAND EXTA 1H KD P-OS, WG
137034BG	34.45	Brushed Gold	SLIDER FOR SLIDEBAR BG
137034BN	64.85	Brushed Nickel	SLIDER FOR SLIDEBAR, BN
137034BRB	37.25	Mediterranean Bronze	SLIDER FOR SLIDEBAR BRB
137034NL	64.85	Polished Nickel	SLIDER FOR SLIDEBAR NL
137034ORB	71.30	Oil Rubbed Bronze	SLIDER FOR SLIDEBAR, ORB
137034SRN	34.45	Spot Resist Brushed Nickel	SLIDER FOR SLIDEBAR SRN
137034WR	71.30	Wrought Iron	SLIDER FOR SLIDEBAR, WR
137388BN	114.80	Brushed Nickel	WS HANDLE KIT, HOT OR COLD, BN
137388ORB	126.25	Oil Rubbed Bronze	WS HANDLE KIT, HOT OR COLD, ORB
137390BN	257.35	Brushed Nickel	WS SPT KIT, BN
137391BN	341.45	Brushed Nickel	RT SPT KIT, BN
137392BN	352.75	Brushed Nickel	ROMAN TUB DIVERTER SPOUT, BN
137393BN	37.50	Brushed Nickel	ROMAN TUB LIFT ROD, BN
137394BN	107.05	Brushed Nickel	ESCT POSI 1H TS, BN
137395BN	115.75	Brushed Nickel	ESCT MNT 1H TS, BN
137395ORB	127.30	Oil Rubbed Bronze	ESCT MNT 1H TS, ORB
137396BN	80.85	Brushed Nickel	HDL LR 1H TS, BN
137396ORB	88.90	Oil Rubbed Bronze	HDL LR 1H TS, ORB
137511BN	24.35	Brushed Nickel	HDL SERVICE KIT BN
137516BN	25.35	Brushed Nickel	ESCT SERVICE KIT (6100BN) BN
137527BN	114.45	Brushed Nickel	HDL ASSY BN
137532BG	30.10	Brushed Gold	ESCUTCHEON BG
137532BL	33.10	Matte Black	ESCUTCHEON KIT, BL
137532BN	30.10	Brushed Nickel	ESCT (T914BN) BN
137534BN	31.40	Brushed Nickel	SPT CAP ASSY BN
137537BN	24.70	Brushed Nickel	HDL SERVICE KIT BN
140028CSL	35.95	Classic Stainless	HOSE & SPRAY CSL
140028ORB	45.20	Oil Rubbed Bronze	HOSE & SPRAY ORB
140245SRS	65.90	Spot Resist Stainless	WAND KIT SRS
140379CSL	123.45	Classic Stainless	WAND CLND KD 1HP-OS CSL
140392BL	80.50	Matte Black	WAND SLRAKD 1HP-OS BL
140392CSL	80.50	Classic Stainless	WAND SLRAKD 1HP-OS CSL
140392S	80.50	Sand	WAND SLRAKD 1HP-OS SND
140392SL	101.75	Stainless	WAND SLRAKD 1HP-OS SL

Part Number	List	Finish	Description
140392V	80.50	Ivory	WAND SLRAKD 1HP-OS IVY
140392W	80.50	Glacier	WAND SLRAKD 1HP-OS GLC
140995CSL	82.45	Classic Stainless	WAND KIT CSL
140996CSL	43.05	Classic Stainless	LEVER HANDLE KIT CSL
140997CSL	19.45	Classic Stainless	DOME KIT CSL
140997ORB	28.10	Oil Rubbed Bronze	DOME KIT ORB
141002CSL	70.30	Classic Stainless	ESCT KIT CSL
141007BL	20.35	Matte Black	HOSE GUIDE KIT, BL
141007SRS	21.30	Spot Resist Stainless	HOSE GUIDE
141008CSL	26.80	Classic Stainless	AERATOR AND RETAINER KIT CSL
141044ORB	180.20	Oil Rubbed Bronze	WAND & HOSE KIT ORB
141044SL	169.60	Stainless	WAND & HOSE KIT SL
141044W	180.20	Glacier/Chrome	WAND & HOSE KIT GLC
1411BG	29.05	Brushed Gold	ESCUTCHEON BG
1411BN	29.05	Brushed Nickel	ESCT UNIVERSAL HHH DKMT BN
1411NL	38.65	Polished Nickel	ESCT UNIVERSAL HHH DKMT NL
1411ORB	38.65	Oil Rubbed Bronze	ESCT UNIVERSAL HHH DKMT ORB
1411WR	38.65	Wrought Iron	ESCT UNIVERSAL HHH DKMT WR
141797CSL	64.90	Classic Stainless	DOME KIT, CSL
141797SRS	27.65	Spot Resist Stainless	DOME KIT SRS
141798BL	94.00	Matte Black	ROMAN TUB ELBOW, BL
141798BN	85.45	Brushed Nickel	ROMAN TUB ELBOW, BN
1417BG	85.45	Brushed Gold	SHR ELBOW HHH DKMT BG
1417BN	85.45	Brushed Nickel	INTL SHR ELBOW HHH DKMT BN
1417NL	123.70	Polished Nickel	INTL SHR ELBOW HHH DKMT NL
1417ORB	94.05	Oil Rubbed Bronze	INTL SHR ELBOW HHH DKMT ORB
1417WR	94.05	Wrought Iron	INTL SHR ELBOW HHH DKMT WR
143321BN	40.35	Brushed Nickel	HANDLE KIT BN BRNTFRD
143321ORB	50.75	Oil Rubbed Bronze	HANDLE KIT ORB BRNTFRD
143322BN	40.55	Brushed Nickel	HANDLE KIT BN EVA
143322ORB	45.65	Oil Rubbed Bronze	HANDLE KIT ORB EVA
143323BN	44.70	Brushed Nickel	3H ESC BN BRNTFRD
143323ORB	49.10	Oil Rubbed Bronze	3H ESC ORB BRNTFRD
143324BN	41.80	Brushed Nickel	3H ESC BN EVA
143324ORB	46.05	Oil Rubbed Bronze	3H ESC ORB EVA
146211BL	20.70	Matte Black	DOME BL
146211W	20.70	Glacier	DOME GLC
146214ORB	59.80	Oil Rubbed Bronze	HANDLE KIT ORB
146214SRS	54.45	Spot Resist Stainless	HANDLE KIT SRS
146217W	21.30	Glacier	DOME GLC
146220CSL	59.80	Classic Stainless	HANDLE KIT CSL
146220SRS	59.80	Spot Resist Stainless	HANDLE KIT SRS
146221SRS	121.20	Spot Resist Stainless	RECEPTOR KIT SRS
146670BG	14.60	Brushed Gold	PLUG BUTTON BG
146670BN	14.90	Brushed Nickel	SLIDEBAR ESC CAP BN
146670NL	30.85	Brushed Nickel	SLIDEBAR ESC CAP NL
146670ORB	16.40	Oil Rubbed Bronze	SLIDEBAR ESC CAP ORB
146670WR	17.45	Wrought Iron	SLIDEBAR ESC CAP WR
146781SRS	40.45	Spot Resist Stainless	1H HANDLE KIT SRS
146783SRS	14.70	Spot Resist Stainless	1H HANDLE DOME KIT SRS
146784SRS	286.60	Spot Resist Stainless	SPOUT KIT SRS
146786BC	87.15	Brushed Chrome	1H KITCHEN SPOUT CHATEAU BC
146786SRS	84.50	Spot Resist Stainless	1H SPOUT KIT SRS
146851SRS	62.70	Spot Resist Stainless	HANDLE KIT SRS
14732CBN	34.90	Classic Brushed Nickel	LR MTL KIT CHT POSI TS CBN
147539SRS	56.20	Spot Resist Stainless	ESCUTCHEON KIT SRS
147540SRS	18.45	Spot Resist Stainless	SET SCREW KIT SRS
147541CSL	58.80	Classic Stainless	HANDLE HUB CSL
147541SRS	56.90	Spot Resist Stainless	HANDLE HUB SRS
147542BN	36.35	Brushed Nickel	HANDLE LEVER BN
147542SRS	36.70	Spot Resist Stainless	HANDLE KIT SRS
147543SRS	355.25	Spot Resist Stainless	SPOUT KIT SRS
147546CSL	105.15	Classic Stainless	WAND CSL

GENUINE PARTS

Moen Genuine Parts

Listed in numerical order

Part Number	List	Finish	Description
147549BN	26.75	Brushed Nickel	LAVESCT BN
147550BN	28.10	Brushed Nickel	LIFT ROD BN
147552BN	56.25	Brushed Nickel	HDLHUBBN
147554BN	16.45	Brushed Nickel	SLOT PLUG BN
147555BN	67.90	Brushed Nickel	VESSEL EXT 5" BN
147557BN	58.70	Brushed Nickel	HDLASSYBN
147558BL	15.35	Matte Black	HARDWARE PACK, MATTE BLACK
147562BN	17.40	Brushed Nickel	SPT ESCT BN
147563BN	19.30	Brushed Nickel	HDL ESCT BN
147564BN	42.60	Brushed Nickel	LIFT ROD BN
147565BN	560.55	Brushed Nickel	RTSPT BN
147566BN	53.15	Brushed Nickel	SPT ESCT BN
147567BN	99.00	Brushed Nickel	HH ESCT BN
147568BN	618.00	Brushed Nickel	RTSPT BN
147569BN	72.80	Brushed Nickel	LIFT ROD BN
147573BN	52.90	Brushed Nickel	HDL KIT BN
147574BN	104.15	Brushed Nickel	ESCT BN
147576BN	109.20	Brushed Nickel	ESCT BN
148479BG	60.80	Brushed Gold	1" HANDLE EXTENSION KIT BG
148479BL	61.20	Matte Black	3FDVTRVLV1" EXT KIT BL
148479BN	60.80	Brushed Nickel	3FDVTRVLV1" EXT KIT BN
148479WR	61.20	Wrought Iron	3FDVTRVLV1" EXT KIT WR
148480BN	40.60	Chrome	3FDVTRVLVESCUT BN
148480ORB	44.70	Oil Rubbed Bronze	3FDVTRVLVESCUT ORB
148820BL	47.70	Matte Black	HDL KIT BL
148820CSL	42.45	Classic Stainless	HANDLE KIT KD PULLDOWN, CSL
148820ORB	46.95	Oil Rubbed Bronze	HANDLE KIT KD PULLDOWN ORB
148820SRS	42.45	Spot Resist Stainless	HANDLE KIT KD PULLDOWN SRS
149111BN	48.35	Brushed Nickel	1H LAV HANDLE KIT BN
149112BN	26.95	Brushed Nickel	1 HANDLE LAV LIFT ROD BN
149113BN	76.75	Brushed Nickel	2H LAV HANDLE KIT BN
149114BN	346.65	Brushed Nickel	SPT, WS BN
149115BN	23.60	Brushed Nickel	LIFT ROD, WS BN
149116BN	447.85	Brushed Nickel	3HOLE RT SPT BN
149118BN	477.00	Brushed Nickel	4HRT SPT BN
149119BN	32.00	Brushed Nickel	LIFT ROD, RT BN
149122BN	53.40	Brushed Nickel	POSI SHR HDL BN
14913BN	22.95	Brushed Nickel	STRM-F ASSY MALE BN
14913BRB	16.45	Mediterranean Bronze	STRM-F ASSY TRAD MALE ORB
14913ORB	25.35	Oil Rubbed Bronze	STRM-F ASSY TRAD MALE ORB
149570BG	82.45	Brushed Gold	HANDLE LEVER & O-RING BG
149570BL	222.65	Matte Black	HANDLE LEVER KIT, BL
149570BLS	54.20	Black/Stainless Steel	HANDLE LEVER KIT, BLS
149570SRS	82.45	Spot Resist Stainless	HANDLE LEVER KIT SRS
149571BG	79.70	Brushed Gold	ESCUTCHEON BG
149571BL	32.80	Matte Black	ESCUTCHEON, BL
149571BLS	61.50	Black/Stainless Steel	ESCUTCHEON, BLS
149571SRS	79.70	Spot Resist Stainless	ESCUTCHEON SRS
149748BG	31.00	Brushed Gold	PLUG BUTTON KIT BG
149748BN	23.15	Brushed Nickel	PLUG BTN KIT BN
149748BRB	34.15	Mediterranean Bronze	PLUG BUTTON KIT BRB
149748NL	33.75	Brushed Nickel	PLUG BUTTON KIT, NL
149748ORB	34.15	Oil Rubbed Bronze	PLUG BUTTON KIT ORB
149748SRN	31.00	Spot Resist Brushed Nickel	PLUG BUTTON KIT SRN
150288SRS	291.75	Spot Resist Stainless	SPOUT KIT SRS
150568BL	32.50	Matte Black	ESCUTCHEON BL
150568BN	29.55	Brushed Nickel	ESCUTCHEON BN
150625BC	35.05	Brushed Chrome	LVR HDL BC
150628BC	10.65	Brushed Chrome	DOME BC
150662ORB	51.25	Oil Rubbed Bronze	HANDLE KIT ORB
150662SRS	42.95	Spot Resist Stainless	HANDLE KIT, SRS
150663ORB	95.65	Oil Rubbed Bronze	ESCT BAR/KD 1 HNDLRING ORB
150663SRS	80.05	Spot Resist Stainless	ESCT BAR/KD 1 HNDLRING SRS
150664CSL	54.75	Classic Stainless	HDL KIT, 1H KD CSL
150664ORB	60.25	Oil Rubbed Bronze	HDL KIT, 1H KD ORB

Part Number	List	Finish	Description
150665ORB	72.35	Oil Rubbed Bronze	HANDLE KIT, 1 HANDLE BAR ORB
150665SRS	65.80	Spot Resist Stainless	HANDLE KIT SRS
150666ORB	27.65	Oil Rubbed Bronze	DOME, 1 HANDLE KITCHEN ORB
150666SRS	15.35	Spot Resist Stainless	DOME SRS
150667ORB	72.35	Oil Rubbed Bronze	ESCT BAR/KD 1 HNDLRING ORB
150667SRS	65.80	Spot Resist Stainless	HANDLE ESCUTCHEON SRS
151018CSL	35.30	Classic Stainless	WASTE ASSEMBLY KIT
151189BL	63.00	Matte Black	PULLDOWN BAR WAND BL
151189ORB	52.65	Oil Rubbed Bronze	WAND KIT BAR/PREP ORB
1512BC	12.00	Brushed Chrome	PLUG BUTTON WS RDMTF BC
1512BG	14.45	Brushed Gold	PLUG BUTTON BG
1512BN	14.45	Brushed Nickel	PLUG BTN WS RDMTF BN
1512NL	15.95	Polished Nickel	PLUG BTN WS RDMTF NL
1512ORB	15.95	Oil Rubbed Bronze	PLUG BUTTON WS RDMTF ORB
1512WR	15.95	Wrought Iron	PLUG BTN WS RDMTF WR
151813BN	35.30	Brushed Nickel	3 HOLE LAV ESCT BN
152027SRN	93.60	Spot Resist Brushed Nickel	TUB SPOUT KIT SRN
152859BG	6.40	Brushed Gold	PLUG BUTTON KIT BG
152859BL	6.90	Black	1255 PLUG BUTTON BL
152859BLS	7.70	Black/Stainless Steel	PLUG BUTTON BLS
152859CSL	6.90	Classic Stainless	1255 PLUG BUTTON CSL
152859NL	6.90	Polished Nickel	1255 PLUG BUTTON NL
152859ORB	6.90	Oil Rubbed Bronze	1255 PLUG BUTTON ORB
152859W	5.65	Glacier	1255 PLUG BUTTON GLC
153641ORB	95.65	Oil Rubbed Bronze	HNDL DOME WTHL 1H KD/ BAR ORB
153641SRS	80.05	Spot Resist Stainless	HNDL DOME WTHL 1H KD/ BAR SRS
153977CSL	65.35	Classic Stainless	PULLDOWN WAND CSL
153977ORB	101.05	Oil Rubbed Bronze	PULLDOWN WAND ORB
153978ORB	57.00	Oil Rubbed Bronze	HANDLE KIT KD PULLDOWN ORB
153978SRS	43.50	Spot Resist Stainless	HANDLE KIT, SRS
154286BG	305.10	Brushed Gold	SPOUT KIT BG
154286BL	384.25	Matte Black	WS LAV SPOUT KIT, BL
154286BN	305.10	Brushed Nickel	WEYMOUTH WS LAV SPT KIT
154286NL	335.75	Polished Nickel	WS LAV SPT KIT NL
154286ORB	335.75	Oil Rubbed Bronze	WEYMOUTH WS LAV SPT KIT
154287BG	30.90	Brushed Gold	LIFT ROD KIT BG
154287BL	84.85	Matte Black	WS LIFT ROD KIT, BL
154287BN	30.90	Brushed Nickel	WEYMOUTH WS LIFT ROD KIT
154287NL	34.05	Polished Nickel	WS LIFT ROD KIT NL
154287ORB	34.05	Oil Rubbed Bronze	WEYMOUTH WS LIFT ROD KIT
154288BG	38.60	Brushed Gold	AERATOR KIT BG
154288BL	27.90	Matte Black	AERATOR SHELL AND INSERT BL
154288ORB	41.25	Oil Rubbed Bronze	WEYMOUTH LAVAER SHELL & INSERT
154288SRS	38.60	Spot Resist Stainless	AERATOR SHELL AND INSERT SRS
154290BG	373.65	Brushed Gold	SPOUT KIT BG
154290BL	396.75	Matte Black	WEYMOUTH 3HRT SPOUT KIT, BL
154290BN	373.65	Brushed Nickel	WEYMOUTH 3HRT SPT
154290NL	396.75	Polished Nickel	3HRT SPT NL
154290ORB	396.75	Oil Rubbed Bronze	WEYMOUTH 3HRT SPT
154291BG	406.25	Brushed Gold	SPOUT KIT BG
154291BL	422.40	Matte Black	4H ROMAN TUB SPOUT KIT, BL
154291BN	406.25	Brushed Nickel	WEYMOUTH 4HRT SPT
154291NL	422.40	Polished Nickel	4HRT SPT NL
154291ORB	422.40	Oil Rubbed Bronze	WEYMOUTH 4HRT SPT
154292BG	25.10	Brushed Gold	LIFT ROD BG
154292BL	63.15	Matte Black	4H ROMAN TUB LIFT ROD KIT, BL
154292BN	25.10	Brushed Nickel	WEYMOUTH 4HRT LIFT ROD KIT
154292NL	27.60	Polished Nickel	4HRT LIFT ROD KIT NL
154292ORB	27.60	Oil Rubbed Bronze	WEYMOUTH 4HRT LIFT ROD KIT
154293BG	649.00	Brushed Gold	SPOUT KIT BG
154293BL	687.10	Matte Black	WALL MOUNT SPOUT KIT, BL

Moen Genuine Parts

Listed in numerical order

Part Number	List	Finish	Description	Part Number	List	Finish	Description
154293BN	649.00	Brushed Nickel	WEYMOUTH WLMT LAVSPT KIT	159014BN	62.35	Brushed Nickel	ESCUTCHEON KIT ICON BN
154293NL	687.10	Polished Nickel	WLMT LAVSPT NL	159018BN	114.80	Brushed Nickel	THERMOSTATIC HDL KIT ROTHBURY BN
154293ORB	687.10	Oil Rubbed Bronze	WEYMOUTH WLMT LAVSPT KIT	159019BN	110.95	Brushed Nickel	THERMOSTATIC HDL KIT 90 DEGREE BN
154294BG	42.45	Brushed Gold	HANDLE LEVER, SCREW & PLUG BUTTON BG	159020BN	116.30	Brushed Nickel	VOLUME HDL KIT ICON BN
154294BL	45.05	Matte Black	WEYMOUTH 1H HDL KIT, BL	159023BN	96.75	Brushed Nickel	ESCT KIT 90 DEGREE BN
154294BN	42.45	Brushed Nickel	WEYMOUTH 1H LAV HDL KIT	159024BN	114.20	Brushed Nickel	THERMOSTATIC HDL KIT ICON BN
154294NL	45.05	Polished Nickel	1H LAV HDL KIT NL	159028BN	112.90	Brushed Nickel	VOLUME HDL KIT 90 DEGREE BN
154294ORB	45.05	Oil Rubbed Bronze	WEYMOUTH 1H LAV HDL KIT	159029BN	116.80	Brushed Nickel	VOLUME HDL KIT ROTHBURY BN
154294SRS	42.45	Spot Resist Stainless	WEYMOUTH 1H HDL KIT	159029ORB	125.05	Oil Rubbed Bronze	VOLUME HDL KIT ROTHBURY ORB
154295BG	59.80	Brushed Gold	STREAM STRAIGHTENER BG	159107BN	60.65	Brushed Nickel	HDL, MTCL WS 2H HDL LAV & BDT BN
154295BL	65.80	Matte Black	WEYMOUTH RT AER SHELL, BL	159264BN	50.85	Brushed Nickel	3F DVTR VLV ESCUT, BN
154295BN	59.80	Brushed Nickel	WEYMOUTH RT AER SHELL & INSRT	159266BN	61.55	Brushed Nickel	3F DVTR LEVER KIT, BN
154295NL	65.80	Polished Nickel	RT AER SHELL & INSERT NL	159561BL	62.85	Matte Black	WAND KIT BL
154295ORB	65.80	Oil Rubbed Bronze	WEYMOUTH RT AER SHELL & INSRT	159561SRS	74.45	Spot Resist Stainless	WAND KIT SRS
154297BG	16.05	Brushed Gold	TRAD SLIDE BAR END CAP BG	160660BG	15.20	Brushed Gold	HANDLE DOME KIT, BG
154297BN	16.35	Brushed Nickel	TRAD SLIDE BAR END CAP BN	160660BL	17.40	Matte Black	HANDLE DOME KIT BL
154297NL	18.00	Polished Nickel	TRAD SLIDE BAR END CAP NL	160660BLS	18.15	Black/Stainless Steel	DOME BLS
154297ORB	18.00	Oil Rubbed Bronze	TRAD SLIDE BAR END CAP ORB	160660BN	9.40	Brushed Nickel	HANDLE DOME, KIT, BN
154298BG	27.05	Brushed Gold	HANDLE INSERT KIT BG	160660BRB	34.00	N/A or Unfinished	DOME KIT
154298BL	29.75	Matte Black	WEYMOUTH EXTMP HDL, BL	160660ORB	10.20	Oil Rubbed Bronze	HANDLE DOME, KIT, ORB
154298BN	27.05	Brushed Nickel	WEYMOUTH EXTMP HDL INSRT BN	160660SRS	17.95	Spot Resist Stainless	DOME SRS
154298NL	27.05	Polished Nickel	EX-TMP HDL INSRT NL	160997SRS	34.30	Spot Resist Stainless	AERATOR KIT 2.0 GPM
154298ORB	29.75	Oil Rubbed Bronze	WEYMOUTH EXTMP HDL INSRT ORB	160998SRS	60.90	Spot Resist Stainless	WAND KIT 1.5 GPM
154299BG	105.35	Brushed Gold	ESCUTCHEON KIT BG	161143SRS	67.40	Spot Resist Stainless	WAND EXTA 1H KD P-OS, BL 1.5GPM
154299BL	203.00	Matte Black	ESCUTCHEON KIT, BL	161143V	47.45	Ivory	WAND EXTA 1H KD P-OS, CHR 1.5GPM IVY
154299BN	105.35	Brushed Nickel	WEYMOUTH EXTMP ESCT KIT BN	161143WG	62.15	Glacier/Pebble	WAND EXTA 1H KD P-OS, WG 1.5GPM
154299NL	115.90	Polished Nickel	EX-TMP ESCT KIT NL	161144SRS	85.45	Spot Resist Stainless	WAND KIT 1.5GPM SRS
154299ORB	115.90	Oil Rubbed Bronze	WEYMOUTH EXTMP ESCT KIT ORB	161147ORB	184.20	Oil Rubbed Bronze	WAND KIT, 7545, ORB 1.5GPM
154302BG	66.25	Brushed Gold	HANDLE HUB & SCREW KIT BG	161148CSL	82.45	Classic Stainless	WAND KIT CSL 1.5GPM
154302BN	66.25	Brushed Nickel	WEYMOUTH POSI HDL KIT BN	161149CSL	113.60	Classic Stainless	WAND KIT CSL 1.5GPM
154302ORB	68.85	Oil Rubbed Bronze	WEYMOUTH POSI HDL KIT ORB	161149ORB	137.50	Oil Rubbed Bronze	WAND KIT ORB 1.5GPM
154306BG	24.30	Brushed Gold	DIVERTER PLUG KIT BG	161149SRS	126.60	Spot Resist Stainless	WAND KIT SRS 1.5GPM
154306BL	44.50	Matte Black	DIVERTER PLUG KIT, BL	161150BL	95.60	Black	PULLDOWN WAND 1.5GPM BL
154306BN	24.30	Brushed Nickel	DIVERTER PLUG KIT BN	161150CSL	117.30	Chrome	PULLDOWN WAND CSL 1.5GPM
154306NL	26.85	Polished Nickel	DIVERTER PLUG KIT NL	161150ORB	120.55	Chrome	PULLDOWN WAND ORB 1.5GPM
154306ORB	26.85	Oil Rubbed Bronze	DIVERTER PLUG KIT ORB	161152SRS	133.20	Spot Resist Stainless	WAND KIT SRS 1.5GPM
155649BN	72.45	Brushed Nickel	SQUARE ESCUTCHEON RING W/GASKET BN	161154SRS	141.10	Spot Resist Stainless	WAND KIT SRS 1.5GPM
155649NL	72.45	Polished Nickel	SQUARE ESCUTCHEON RING W/GASKET NL	161156ORB	77.85	Oil Rubbed Bronze	WAND KIT BAR/PREP ORB 1.5GPM
155649ORB	79.70	Oil Rubbed Bronze	SQUARE ESCUTCHEON RING W/GASKET ORB	161156SRS	74.50	Spot Resist Stainless	WAND KIT 1.5GPM SRS
155650BG	64.65	Brushed Gold	ROUND ESCUTCHEON RING W/GASKET BG	161157ORB	101.05	Oil Rubbed Bronze	PULLDOWN WAND ORB 1.5GPM
155650BL	176.35	Matte Black	ROUND ESCUTCHEON RING, BL	161157SRS	65.35	Spot Resist Stainless	WAND KIT 1.5GPM SRS
155650BN	64.65	Brushed Nickel	ROUND ESCUTCHEON RING W/GASKET BN	161909BG	45.55	Brushed Gold	HANDLE KIT BG
155650NL	64.65	Polished Nickel	ROUND ESCUTCHEON RING W/GASKET NL	161909BN	45.55	Brushed Nickel	1H 1H HANDLE KIT BN
155650ORB	71.15	Oil Rubbed Bronze	ROUND ESCUTCHEON RING W/GASKET ORB	161909NL	70.95	Brushed Nickel	1H 1H HANDLE KIT, NL
156270SRS	74.35	Spot Resist Stainless	1H SPOUT KIT SRS	161909ORB	51.35	Oil Rubbed Bronze	1H 1H HANDLE KIT ORB
157131BC	59.50	Brushed Chrome	ESCT POSI-TEMP BC	161917BG	21.65	Brushed Gold	LIFT ROD BG
157276BG	69.30	Brushed Gold	HAND SHOWER (1.75 GPM) BG	161917BN	21.65	Brushed Nickel	1H 1H LIFT ROD BN
157328BL	64.10	Matte Black	ESCUTCHEON KIT BL	161917ORB	22.00	Oil Rubbed Bronze	1H 1H LIFT ROD ORB
157328ORB	64.10	Oil Rubbed Bronze	KITCHEN DECK PLATE ORB	161919ORB	46.85	Oil Rubbed Bronze	1H 1H DECK PLATE ORB
157328SRS	58.25	Spot Resist Stainless	ESCUTCHEON & GASKET KIT SRS	161942BG	95.65	Brushed Gold	WIDESPREAD HANDLE KIT BG
158080BN	20.35	Brushed Nickel	90 DEGREE WLMT SPT ESCT BN	161942BN	95.65	Brushed Nickel	WIDESPREAD HANDLE KIT BN
158198SRS	89.65	Spot Resist Stainless	REFLEX SPOUT SRVC KT, SRS	161942NL	95.65	Brushed Nickel	WIDESPREAD HANDLE KIT, NL
158493BN	33.35	Brushed Nickel	FINA 1H HC HANDLE BN	161942ORB	109.10	Oil Rubbed Bronze	WIDESPREAD HANDLE KIT ORB
158532ORB	14.15	Oil Rubbed Bronze	HANDLE DOME KIT ORB	161944BG	216.30	Brushed Gold	WIDESPREAD SPOUT KIT BG
				161944BN	216.30	Brushed Nickel	WIDESPREAD SPOUT KIT BN
				161944NL	216.30	Brushed Nickel	WIDESPREAD SPOUT KIT, NL
				161944ORB	247.90	Oil Rubbed Bronze	WIDESPREAD SPOUT KIT ORB
				161945BN	57.90	Brushed Nickel	CENTERSET HANDLE KIT BN
				161945ORB	77.35	Oil Rubbed Bronze	CENTERSET HANDLE KIT ORB
				161947BG	471.30	Brushed Gold	SPOUT KIT BG

Moen Genuine Parts

Listed in numerical order

Part Number	List	Finish	Description
161947BN	471.30	Brushed Nickel	NON-DIVERTING RT SPOUT BN
161947NL	471.30	Brushed Nickel	NON-DIVERTING RT SPOUT, NL
161947ORB	445.55	Oil Rubbed Bronze	NON-DIVERTING RT SPOUT ORB
161949BG	498.40	Brushed Gold	ROMAN TUB SPOUT BG
161949BN	498.40	Brushed Nickel	DIVERTING RT SPOUT BN
161949NL	498.40	Brushed Nickel	DIVERTING RT SPOUT, NL
161949ORB	480.30	Oil Rubbed Bronze	DIVERTING RT SPOUT ORB
161950BG	23.00	Brushed Gold	DIVERTER LIFT ROD BG
161950BN	23.00	Brushed Nickel	ROMAN TUB LIFT ROD BN
161950NL	23.00	Brushed Nickel	ROMAN TUB LIFT ROD, NL
161950ORB	23.80	Oil Rubbed Bronze	ROMAN TUB LIFT ROD ORB
161952BG	99.35	Brushed Gold	ESCUTCHEON BG
161952BN	99.35	Brushed Nickel	POSI SHOWERING ESCUTCHEON BN
161952NL	99.35	Brushed Nickel	POSI SHOWERING ESCT, NL
161952ORB	77.90	Oil Rubbed Bronze	POSI SHOWERING ESCUTCHEON ORB
161953BG	85.40	Brushed Gold	ESCUTCHEON BG
161953BN	85.40	Brushed Nickel	MOENTROL SHOWERING ESCUTCHEON BN
161953NL	85.40	Brushed Nickel	MOENTROL ESCT, NL
161953ORB	59.10	Oil Rubbed Bronze	MOENTROL SHOWERING ESCUTCHEON ORB
161954BG	57.90	Brushed Gold	HANDLE KIT BG
161954BN	66.50	Brushed Nickel	SHOWERING HANDLE BN
161954NL	66.50	Brushed Nickel	SHOWERING HANDLE, NL
161954ORB	71.95	Oil Rubbed Bronze	SHOWERING HANDLE ORB
162BN	159.80	Brushed Nickel	ESCUTCHEON EXTENSION BN
162ORB	175.85	Oil Rubbed Bronze	ESCUTCHEON EXTENSION ORB
163053BG	281.55	Brushed Gold	WALLMOUNT SPOUT KIT BG
163053BN	281.55	Brushed Nickel	WALLMOUNT SPOUT KIT, BN
163053NL	281.55	Brushed Nickel	WALLMOUNT SPOUT KIT, NL
163053ORB	327.05	Oil Rubbed Bronze	WALLMOUNT SPOUT KIT, ORB
163138BN	57.90	Brushed Nickel	HANDLE KIT COLD BN
163153BG	40.65	Brushed Gold	ESCUTCHEON BG
163153BN	40.65	Brushed Nickel	TRANSFER VALVE ESCUTCHEON BN
163153NL	40.65	Brushed Nickel	TRANSFER VALVE ESCT, NL
163153ORB	49.10	Oil Rubbed Bronze	TRANSFER VALVE ESCUTCHEON ORB
163153SRN	48.65	Spot Resist Brushed Nickel	DIVERTER VALVE ESCUTCHEON SRN
163244SRS	80.35	Spot Resist Stainless	WAND KIT SRS 1.5GPM
163245SRS	244.70	Spot Resist Stainless	SPOUT KIT SRS
163246CSL	80.60	Classic Stainless	1.5 GPM WAND KKIT CSL
163248CSL	81.10	Classic Stainless	1.5 GPM WAND KIT CSL
163248ORB	143.65	Oil Rubbed Bronze	1.5 GPM WAND KIT ORB
163248SRS	81.10	Spot Resist Stainless	PULL OUT WAND 1.5GPM SRS
163248W	62.15	Glacier	1.5 GPM WAND KIT GLC
163249ORB	124.40	Oil Rubbed Bronze	RECEPTOR KIT ORB
163792BN	6.95	Brushed Nickel	CAP, BN
163792ORB	7.80	Oil Rubbed Bronze	CAP, ORB
163866BRB	28.35	Mediterranean Bronze	LIFT ROD KIT BRB
163949BN	4.85	Brushed Nickel	RUBBER LIFT ROD PLUG BUTTON WARM GREY
163949ORB	5.15	Oil Rubbed Bronze	RUBBER LIFT ROD PLUG BUTTON BROWN
163BG	17.75	Brushed Gold	ESCUTCHEON SCREWS (2) BG
163BL	19.50	Matte Black	ESCUT SCREW LGD/MNT/CHT TS BL
163BN	17.75	Brushed Nickel	ESCUT SCREW LGD/MNT/CHT TS BN
163WR	19.50	Wrought Iron	ESCT SCR W LGD/MNT/CHT TSWR
164486BG	19.30	Brushed Gold	SIDE SPRAY BG
164486BL	109.45	Matte Black	SIDE SPRAY BL
164486NL	32.55	Polished Nickel	SIDE SPRAY NL
164486ORB	67.80	Oil Rubbed Bronze	SIDE SPRAY ORB
164486SRS	19.30	Spot Resist Stainless	SIDE SPRAY SRS
164487BG	40.05	Brushed Gold	HANDLE KIT BG
164487BL	33.00	Matte Black	WEYMOUTH KITCHEN HANDLE KIT BL

Part Number	List	Finish	Description
164487NL	39.60	Polished Nickel	WEYMOUTH KITCHEN HANDLE KIT NL
164487ORB	46.60	Oil Rubbed Bronze	WEYMOUTH KITCHEN HANDLE KIT ORB
164487SRS	40.05	Spot Resist Stainless	WEYMOUTH KITCHEN HANDLE KIT SRS
164488BG	50.75	Brushed Gold	AERATOR KIT BG
164488NL	50.75	Polished Nickel	AERATOR SHELL AND INSERT NL
164488ORB	57.80	Oil Rubbed Bronze	AERATOR SHELL AND INSERT ORB
164488SRS	50.75	Spot Resist Stainless	AERATOR SHELL AND INSERT SRS
165003BG	33.35	Brushed Gold	LIFT ROD BG
165003BL	46.00	Matte Black	1H LAV LIFT ROD KIT BL
165193BL	104.55	Matte Black	WIDESPREAD HANDLE KIT BL
165193BN	72.60	Brushed Nickel	WIDESPREAD HANDLE KIT BN
165212BG	113.90	Brushed Gold	HANDSHOWER BG
165903BL	39.80	Matte Black	1H1H HANDLE KIT, BL
165903BN	36.20	Brushed Nickel	1H1H HANDLE KIT BN
165904BL	43.65	Matte Black	1H1H HANDLE DOME KIT BL
165904BN	39.75	Brushed Nickel	1H1H HANDLE DOME KIT BN
165905BL	89.35	Brushed Nickel	ARRIS LEVER HANDLE KIT BL
165905BN	81.15	Brushed Nickel	LAVATORY HANDLE KIT BN
165906BL	429.50	Matte Black	WIDESPREAD SPOUT KIT BL
165906BN	390.40	Brushed Nickel	WIDESPREAD SPOUT KIT BN
165908BL	412.10	Matte Black	ROMAN TUB NON-DIVERTING SPOUT, BL
165908BN	374.60	Brushed Nickel	ROMAN TUB NON-DIVERTING TUB SPOUT BN
165909BL	580.15	Matte Black	ROMAN TUB DIVERTING SPOUT, BL
165909BN	527.40	Brushed Nickel	ROMAN TUB DIVERTING TUB SPOUT BN
165910BL	93.70	Matte Black	ROMAN TUB LIFT ROD, BL
165910BN	85.20	Brushed Nickel	ROMAN TUB LIFT ROD BN
165913BN	55.55	Brushed Nickel	POSI-TEMP SHOWER HANDLE KIT BN
165916BL	122.25	Matte Black	THERMOSTATIC HANDLE KIT BL
165916BN	111.15	Brushed Nickel	THERMOSTATIC HANDLE KIT BN
165917BL	121.40	Matte Black	VOLUME CONTROL HANDLE KIT BL
165917BN	110.40	Brushed Nickel	VOLUME CONTROL HANDLE KIT BN
165998BG	39.90	Brushed Gold	SPOUT CAP BG
165998BL	32.90	Matte Black	WEYMOUTH KITCHEN SPOUT CAP BL
165998NL	25.10	Polished Nickel	WEYMOUTH KITCHEN SPOUT FINIAL
165998ORB	39.90	Oil Rubbed Bronze	WEYMOUTH KITCHEN SPOUT FINIAL
165998SRS	39.90	Spot Resist Stainless	WEYMOUTH KITCHEN SPOUT FINIAL
168492BG	153.55	Brushed Gold	WAND KIT BG
168492BL	153.55	Matte Black	WAND KIT BL
168492BLS	168.85	Black/Stainless Steel	WAND KIT BLS
168492SRS	153.55	Spot Resist Stainless	WAND KIT SRS
168493BG	171.25	Brushed Gold	SPOUT KIT BG
168493BL	170.00	Matte Black	SPOUT KIT BL
168493BLS	188.40	Black/Stainless Steel	SPOUT BLS
168493MSRS	149.60	Spot Resist Stainless Microban	FLANGLESS SPOUT KIT
168494BG	40.15	Brushed Gold	HANDLE KIT BG
168494BL	40.15	Matte Black	HANDLE KIT BL
168494BLS	44.15	Black/Stainless Steel	HANDLE BLS
168494SRS	40.15	Spot Resist Stainless	HANDLE SRS
168495SRS	247.30	Spot Resist Stainless	KITCHEN SPOUT SRS
168496BL	93.25	Matte Black	SIDE SPRAY KIT, BL
168496SRS	54.30	Spot Resist Stainless	SIDE SPRAY KIT SRS
168497BG	159.20	Brushed Gold	SPOUT KIT BG
168497BL	136.60	Matte Black	BAR SPOUT BL
168497BLS	175.20	Black/Stainless Steel	SPOUT BLS
168497SRS	159.20	Spot Resist Stainless	BAR SPOUT SRS
168501BG	265.95	Brushed Gold	SPOUT KIT BG
168501BL	256.80	Black	SPOUT KIT BL

Listed in numerical order

Part Number	List	Finish	Description
168501SRS	265.95	Spot Resist Stainless	SPOUT KIT SRS
168502BG	46.85	Brushed Gold	HANDLE KIT BG
168502BL	45.40	Black	HANDLE KIT BL
168502BLC	295.60	Matte Black/Chrome	HANDLE KIT BLC
168502SRS	46.85	Spot Resist Stainless	HANDLE SRS
168503BG	238.80	Brushed Gold	SPOUT KIT BG
168503BL	230.45	Black	SPOUT KIT BL
168503SRS	238.80	Spot Resist Stainless	SPOUT KIT SRS
168682BL	381.05	Brushed Nickel	ARRISWALLMOUNT SPOUT KIT BL
168682BN	346.45	Brushed Nickel	WALL MOUNT SPOUT KIT BN
168683BL	124.05	Matte Black	3/4 THERMOSTATIC SHOWER ESCUTCHEON
168683BN	124.05	Brushed Nickel	3/4 THERMOSTATIC SHOWER ESCUTCHEON BN
169245ORB	13.75	Oil Rubbed Bronze	DOME KIT, ORB
169250ORB	84.25	Oil Rubbed Bronze	WAND KIT ORB
169252ORB	55.75	Oil Rubbed Bronze	ESCUTCHEON & GASKET KIT, ORB
170145ORB	531.40	Oil Rubbed Bronze	VESTIGE SPOUT KIT ORB
170145SRS	496.30	Spot Resist Stainless	VESTIGE SPOUT KIT SRS
172654BG	52.80	Brushed Gold	SHOWER HANDLE KIT BG
172654BL	52.75	Matte Black	SHOWER HANDLE KIT BL
172654BN	52.80	Brushed Nickel	SHOWER HANDLE KIT
172655BG	49.30	Brushed Gold	TRANSFER TRIM ESCUTCHEON BG
172655BL	58.80	Matte Black	TRANSFER TRIM ESCUTCHEON BL
172655BN	49.30	Brushed Nickel	TRANSFER TRIM ESCUTCHEON BN
172658BG	67.70	Brushed Gold	DIVERter LIFT ROD BG
172658BN	67.70	Brushed Nickel	ROMAN TUB LIFT ROD
172659BG	391.90	Brushed Gold	ROMAN TUB SPOUT BG
172659BN	391.90	Brushed Nickel	4H ROMAN TUB SPOUT KIT
172660BG	394.30	Brushed Gold	3H ROMAN TUB SPOUT KIT BG
172660BL	433.75	Brushed Nickel	ALIGN ROMAN TUB SPOUT KIT BL
172660BN	394.30	Brushed Nickel	3H ROMAN TUB SPOUT KIT
172661BG	60.00	Brushed Gold	WIDESPREAD LIFT ROD KIT BG
172661BL	52.85	Matte Black	WIDESPREAD LIFT ROD KIT BL
172661BN	60.00	Brushed Nickel	WIDESPREAD LIFT ROD
172662BG	33.40	Brushed Gold	WIDESPREAD SPOUT KIT BG
172662BL	190.20	Matte Black	WIDESPREAD SPOUT KIT BL
172662BN	33.40	Brushed Nickel	WIDESPREAD SPOUT KIT
172663BG	77.25	Brushed Gold	HANDLE KIT BG
172663BL	76.60	Matte Black	HANDLE KIT BL
172663BN	77.25	Brushed Nickel	HANDLE KIT
172665BG	38.15	Brushed Gold	HANDLE KIT WITH RED/BLUE BG
172665BL	64.65	Matte Black	SINGLE HOLE HANDLE KIT WITH RED/BLUE BL
172665BN	40.35	Brushed Nickel	SINGLE HOLE HANDLE KIT WITH RED/BLUE BN
172666SRN	19.10	Chrome	3HOLE ESCUTCHEON KIT SRN
172667BG	16.10	Brushed Gold	LIFT ROD BG
172667BL	24.55	Matte Black	SINGLE HNDL LOW PROFILE LAV LIFT ROD BL
172667BN	16.10	Brushed Nickel	SINGLE HANDLE LOW PROFILE LAV LIFT ROD K
172668BG	17.05	Brushed Gold	SINGLE HANDLE SINGLE HOLE ESCUTCHEON BG
172668BL	24.80	Matte Black	SINGLE HNDL SINGLE HOLE ESCUTCHEON BL
172668BN	17.05	Brushed Nickel	SINGLE HANDLE SINGLE HOLE ESCUTCHEON BN
172669BG	78.45	Brushed Gold	ESCUTCHEON BG
172669BN	78.45	Brushed Nickel	MOENTROL SHOWER ESCUTCHEON KIT
173488BL	14.60	Black	TRAD/TRANS PUMP KNOB KIT BL
173816BG	86.60	Brushed Gold	WAND KIT
173816BL	59.75	Matte Black	WAND KIT BL
173816BLS	59.90	Black/Stainless Steel	WAND KIT BLS
173816SRS	46.10	Spot Resist Stainless	WAND KIT SRS
173988SRS	111.90	Spot Resist Stainless	WAND KIT SRS

Part Number	List	Finish	Description
174333BG	74.45	Brushed Gold	POSIESCUTCHEON RED/BLUE BG
174333BL	56.90	Matte Black	POSIESCUTCHEON RED/BLUE BL
174333BN	74.45	Brushed Nickel	POSIESCUTCHEON RED/BLUE
174948MBRB	138.85	Mediterranean Brz Microban	FLANGELESS SPOUT KIT 173889 MBRB
175376BN	58.60	Brushed Nickel	ANDLE KIT BN
175376NL	58.60	Polished Nickel	HANDLE KIT NL
175376ORB	64.50	Oil Rubbed Bronze	HANDLE KIT ORB
175377BN	77.35	Brushed Nickel	ESCUTCHEON KIT BN
175377NL	77.35	Polished Nickel	ESCUTCHEON KIT NL
175377ORB	85.05	Oil Rubbed Bronze	ESCUTCHEON KIT ORB
175378BN	53.05	Brushed Nickel	LIFT ROD BN
175378NL	53.05	Polished Nickel	LIFT ROD NL
175378ORB	58.35	Oil Rubbed Bronze	LIFT ROD ORB
175379BN	76.10	Brushed Nickel	LEVER HANDLE KIT BN
175379NL	76.10	Polished Nickel	LEVER HANDLE KIT NL
175379ORB	83.70	Oil Rubbed Bronze	LEVER HANDLE KIT ORB
175380BN	96.85	Brushed Nickel	CROSS HANDLE KIT BN
175380NL	96.85	Polished Nickel	CROSS HANDLE KIT NL
175380ORB	106.60	Oil Rubbed Bronze	CROSS HANDLE KIT ORB
175381BN	249.85	Brushed Nickel	WIDESPREAD SPOUT KIT BN
175381NL	249.85	Polished Nickel	WIDESPREAD SPOUT KIT NL
175381ORB	274.85	Oil Rubbed Bronze	WIDESPREAD SPOUT KIT ORB
175382BN	480.75	Brushed Nickel	3H ROMAN TUB SPOUT BN
175382NL	480.75	Polished Nickel	3H ROMAN TUB SPOUT NL
175382ORB	528.85	Oil Rubbed Bronze	3H ROMAN TUB SPOUT ORB
175383BN	77.25	Brushed Nickel	ESCUTCHEON BN
175383NL	77.25	Polished Nickel	ESCUTCHEON NL
175383ORB	85.05	Oil Rubbed Bronze	ESCUTCHEON ORB
175983ORB	267.25	Oil Rubbed Bronze	KITCHEN SPOUT KIT ORB
175983SRS	219.05	Spot Resist Stainless	KITCHEN SPOUT KIT SRS
175985ORB	43.90	Oil Rubbed Bronze	KITCHEN HANDLE KIT ORB
175985SRS	38.00	Spot Resist Stainless	KITCHEN HANDLE KIT SRS
176077BL	120.85	Black	FLANGELESS SPOUT KIT 173888 BL
176077BRB	146.25	Mediterranean Bronze	FLANGELESS SPOUT KIT 173888 BRB
176077MSRS	119.25	Spot Resist Stainless Microban	FLANGELESS SPOUT KIT 173888 MSRS
176077ORB	146.25	Oil Rubbed Bronze	FLANGELESS SPOUT KIT
176078BL	79.30	Matte Black	FLANGELESS SPOUT KIT BL
176078BRB	150.60	Mediterranean Bronze	FLANGELESS SPOUT KIT 173890 BRB
176078ORB	150.60	Oil Rubbed Bronze	FLANGELESS SPOUT KIT
176078SRS	114.25	Spot Resist Stainless	FLANGELESS SPOUT KIT 173890 SRS
176079BL	126.25	Black	FLANGELESS SPOUT KIT 173892 BL
176079ORB	153.25	Oil Rubbed Bronze	FLANGELESS SPOUT KIT
176079SRS	135.65	Spot Resist Stainless	FLANGELESS SPOUT KIT 173892 SRS
176081SRS	151.60	Spot Resist Stainless	FLANGELESS SPOUT KIT 173895 SRS
176086SRS	146.60	Spot Resist Stainless	FLANGELESS SPOUT KIT 172905 SRS
176101BL	47.20	Matte Black	HANDLE KIT H/C BL
176101BN	42.95	Brushed Nickel	1H LAV/HDL KIT BN
176261ORB	98.45	Oil Rubbed Bronze	FLANGELESS SPOUT KIT 173893 ORB
176633BG	53.70	Brushed Gold	DIVERter RING BG
176633BL	59.05	Matte Black	DIVERter RING, BL
176633BN	53.70	Brushed Nickel	DIVERter RING BN
176633NL	53.70	Polished Nickel	DIVERter RING NL
176633ORB	59.00	Oil Rubbed Bronze	DIVERter RING ORB
177138BN	61.50	Brushed Nickel	HANDLE KIT HOT/COLD BN
177138ORB	67.75	Oil Rubbed Bronze	HANDLE KIT HOT/COLD ORB
177167BN	60.60	Brushed Nickel	1H LAV ESCUTCHEON PLATE BN
177167NL	60.60	Polished Nickel	1H LAV ESCUTCHEON PLATE NL
177167ORB	66.50	Oil Rubbed Bronze	1H LAV ESCUTCHEON PLATE ORB

GENUINE PARTS

Moen Genuine Parts

Listed in numerical order

Part Number	List	Finish	Description
177573ORB	509.65	Oil Rubbed Bronze	SPOUT KIT, ORB
177573SRS	485.00	Spot Resist Stainless	SPOUT KIT, SRS
177574ORB	532.45	Oil Rubbed Bronze	SPOUT KIT, ORB
177574SRS	511.50	Spot Resist Stainless	SPOUT KIT, SRS
177575SRS	466.25	Spot Resist Stainless	SPOUT KIT, SRS
177576SRS	558.85	Spot Resist Stainless	SPOUT KIT, SRS
177701BN	61.65	Brushed Nickel	KNOB, BDT DVRTR BN
177701ORB	67.80	Oil Rubbed Bronze	KNOB, BDT DVRTR ORB
177702BN	54.65	Brushed Nickel	ESCUT, BDT DVRTR BN
177702ORB	60.05	Oil Rubbed Bronze	ESCUT, BDT DVRTR ORB
178216ORB	51.45	Oil Rubbed Bronze	1H KITCHEN HANDLE AND SET SCREW KIT ORB
178216SRS	45.65	Spot Resist Stainless	1H KITCHEN HANDLE AND SET SCREW KIT SRS
178217ORB	23.40	Oil Rubbed Bronze	1H KITCHEN HANDLE DOME KIT ORB
178217SRS	19.95	Spot Resist Stainless	1H KITCHEN HANDLE DOME KIT SRS
178218ORB	155.10	Oil Rubbed Bronze	1H KITCHEN SPOUT KIT ORB
178218SRS	173.55	Spot Resist Stainless	1H KITCHEN SPOUT KIT SRS
178219ORB	68.45	Oil Rubbed Bronze	1H KITCHEN SPOUT HUB KIT ORB
178219SRS	51.75	Spot Resist Stainless	1H KITCHEN SPOUT HUB KIT SRS
178231ORB	28.05	Oil Rubbed Bronze	2H KITCHEN SPOUT CAP ORB
178231SRS	36.95	Spot Resist Stainless	2H KITCHEN SPOUT CAP SRS
178232ORB	66.25	Oil Rubbed Bronze	2H KITCHEN HOT HANDLE KIT ORB
178232SRS	55.90	Spot Resist Stainless	2H KITCHEN HOT HANDLE KIT SRS
178233ORB	122.15	Oil Rubbed Bronze	2H KITCHEN SPOUT HUB KIT ORB
178233SRS	111.05	Spot Resist Stainless	2H KITCHEN SPOUT HUB KIT SRS
178234ORB	60.65	Oil Rubbed Bronze	ESCUTCHEON ORB
178234SRS	49.50	Spot Resist Stainless	ESCUTCHEON SRS
178462BN	56.35	Brushed Nickel	LEVER HANDLE KIT BN
178462NL	56.35	Polished Nickel	LEVER HANDLE KIT NL
178462ORB	62.05	Oil Rubbed Bronze	LEVER HANDLE KIT ORB
178467BG	44.90	Brushed Gold	3F TRANSFER VALVE ESCUTCHEON KIT BG
178467BL	49.35	Matte Black	DIVERTER VALVE ESCUTCHEON BL
178467BN	44.90	Brushed Nickel	DIVERTER VALVE ESCUTCHEON BN
178888BN	303.65	Brushed Nickel	SPOUT KIT, BN
178888ORB	334.05	Oil Rubbed Bronze	SPOUT KIT, ORB
178890BN	297.80	Brushed Nickel	SPOUT KIT, BN
178890ORB	327.50	Oil Rubbed Bronze	SPOUT KIT, ORB
178892BN	327.60	Brushed Nickel	SPOUT KIT, BN
178892ORB	360.40	Oil Rubbed Bronze	SPOUT KIT, ORB
178894BN	400.25	Brushed Nickel	SPOUT KIT, BN
178894ORB	440.15	Oil Rubbed Bronze	SPOUT KIT, ORB
178896BN	421.35	Brushed Nickel	SPOUT KIT, BN
178896ORB	463.45	Oil Rubbed Bronze	SPOUT KIT, ORB
179084ORB	66.25	Oil Rubbed Bronze	2H KITCHEN COLD HANDLE KIT ORB
179084SRS	55.90	Spot Resist Stainless	2H KITCHEN COLD HANDLE KIT SRS
179085ORB	164.75	Oil Rubbed Bronze	2H KITCHEN SPOUT KIT ORB
179085SRS	189.35	Spot Resist Stainless	2H KITCHEN SPOUT KIT SRS
179086ORB	76.10	Oil Rubbed Bronze	TRADITIONAL SIDE SPRAY W/ POI SRS
179086SRS	64.55	Spot Resist Stainless	TRADITIONAL SIDE SPRAY W/ POI SRS
179353SRS	21.05	Spot Resist Stainless	AERATOR KIT 1.5GPM SRS
179354BN	310.65	Brushed Nickel	LIFT ROD KIT BN
179354NL	310.65	Polished Nickel	LIFT ROD KIT NL
179354ORB	341.75	Oil Rubbed Bronze	LIFT ROD KIT ORB
179655ORB	50.15	Oil Rubbed Bronze	HANDLE KIT, OBR
179655SRS	47.40	Spot Resist Stainless	HANDLE KIT, SRS
179656ORB	74.00	Oil Rubbed Bronze	WAND KIT, ORB
179656SRS	69.65	Spot Resist Stainless	WAND KIT, SRS
179657ORB	212.85	Oil Rubbed Bronze	RECEPTOR KIT, OBR
179657SRS	225.90	Spot Resist Stainless	RECEPTOR KIT, SRS
179675SRN	28.05	Spot Resist Brushed Nickel	HANDLE KIT HOT, SRN

Part Number	List	Finish	Description
179781BL	25.85	Matte Black	CS LIFT ROD KIT BL
179781BN	23.45	Brushed Nickel	CS LIFT ROD KIT BN
179782BL	66.95	Matte Black	CENTERSET HANDLE KIT BL
179782BN	60.90	Brushed Nickel	CENTERSET HANDLE KIT BN
179784BL	89.00	Matte Black	WIDESPREAD HANDLE KIT BL
179784BN	80.90	Brushed Nickel	WIDESPREAD HANDLE KIT BN
179785BN	310.35	Brushed Nickel	NON DIVERTING RT SPOUT BN
179786BL	50.85	Matte Black	WIDESPREAD LIFT ROD KIT BL
179786BN	46.20	Brushed Nickel	WIDESPREAD LIFT ROD KIT BN
179787BL	228.70	Matte Black	WIDESPREAD SPOUT KIT BL
179787BN	207.90	Brushed Nickel	WIDESPREAD SPOUT KIT BN
179790BL	64.05	Matte Black	ESCUTCHEON BL
179790BN	58.20	Brushed Nickel	ESCUTCHEON BN
179792BL	75.70	Matte Black	HANDLE KIT BL
179792BN	68.85	Brushed Nickel	HANDLE KIT BN
179793ORB	28.55	Oil Rubbed Bronze	SIDESPRAY HOSE GUIDE ORB
179793SRS	33.65	Spot Resist Stainless	SIDESPRAY HOSE GUIDE SRS
179827BLC	355.35	Matte Black/Chrome	1H LAV HANDLE KIT, BLC
179828BL	45.10	Matte Black	LIFT ROD KIT, BL
179830BLC	339.30	Matte Black/Chrome	WS HANDLE KIT, BLC
179831BLC	308.45	Matte Black/Chrome	1H LAV SPOUT KIT, BLC
180059BL	104.60	Matte Black	WAND KIT 1.0GPM BL
180059SRS	104.60	Spot Resist Stainless	WAND KIT 1.0GPM
180073BN	63.55	Brushed Nickel	DIVERTER LIFT ROD BN
180073NL	63.55	Polished Nickel	DIVERTER LIFT ROD NL
180073ORB	69.85	Oil Rubbed Bronze	DIVERTER LIFT ROD ORB
181066BN	10.35	Brushed Nickel	MALE THREAD 1.2GPM AERATOR BN
181080BG	36.70	Brushed Gold	LAVAER SHELL & INSERT BG
181087BN	19.25	Brushed Nickel	KIT AER CHR 1.2GPM
181106BC	80.85	Brushed Chrome	HANDLE KIT COLD, BC
181107BC	80.85	Brushed Chrome	HANDLE KIT HOT, BC
181502BN	43.25	Brushed Nickel	3F DVTR VLV ESCUT, BN
181502ORB	47.70	Oil Rubbed Bronze	3F DVTR VLV ESCUT, ORB
181602BN	61.40	Brushed Nickel	3F DVTR LEVER KIT, BN
181602NL	61.40	Polished Nickel	3F DVTR LEVER KIT, NL
181602ORB	67.60	Oil Rubbed Bronze	3F DVTR LEVER KIT, ORB
181603BN	137.50	Brushed Nickel	3F DVTR LEVER KIT, BN
181603ORB	151.25	Oil Rubbed Bronze	3F DVTR LEVER KIT, ORB
181929BG	288.50	Brushed Gold	SWING ARM KIT
181929BL	220.05	Matte Black	SWING ARM BL
181929BLS	246.20	Black/Stainless Steel	SWING ARM & COLLAR BLS
181929SRS	223.85	Spot Resist Stainless	SWING ARM AND COLLAR KIT
181930BG	176.85	Brushed Gold	SPRING AND BEARING KIT
181930BL	115.30	Matte Black	SPRING SPOUT AND BEARING BL
181930BLS	138.65	Black/Stainless Steel	SPRING & BEARING KIT BLS
181930SRS	126.05	Spot Resist Stainless	SPRING AND BEARING KIT
182074BN	618.75	Brushed Nickel	4H ROMAN TUB SPOUT BN
182074ORB	680.65	Oil Rubbed Bronze	4H ROMAN TUB SPOUT ORB
182212BN	188.25	Brushed Nickel	BRANTFORD WS SPOUT KIT
182212ORB	206.55	Oil Rubbed Bronze	BRANTFORD WS SPOUT KIT
182213BN	167.65	Brushed Nickel	EVAWS SPOUT KIT BN
182213ORB	203.80	Oil Rubbed Bronze	EVAWS SPOUT KIT ORB
182244BN	59.25	Brushed Nickel	HANDLE KIT HOT/COLD, BN
182244ORB	65.15	Oil Rubbed Bronze	HANDLE KIT HOT/COLD, ORB
182496BN	55.90	Brushed Nickel	HANDLE KIT HOT/COLD, BN
182496NL	55.90	Polished Nickel	HANDLE KIT HOT/COLD, NL
182496ORB	61.50	Oil Rubbed Bronze	HANDLE KIT HOT/COLD, ORB
182632BG	38.10	Brushed Gold	ESCUTCHEON BRUSHED GOLD
182632BL	39.30	Matte Black	UPPER/LOWER ESCUTCHEON W/SET SCREW BL
182632BN	38.10	Brushed Nickel	UPPER/LOWER ESCUTCHEON W/SET SCREW BN
182632ORB	39.30	Oil Rubbed Bronze	UPPER/LOWER ESCUTCHEON W/SET SCREW ORB
182633BL	85.20	Matte Black	ELBOW W/CHECK VALVE BL
182633BN	82.30	Brushed Nickel	ELBOW W/CHECK VALVE BN
182633ORB	85.20	Oil Rubbed Bronze	ELBOW W/CHECK VALVE ORB
182636BL	8.60	Matte Black	DIVERTER HANDLE CAP BL
182636BN	8.30	Brushed Nickel	DIVERTER HANDLE CAP BN

Moen Genuine Parts

Listed in numerical order

Part Number	List	Finish	Description	Part Number	List	Finish	Description
182636ORB	8.60	Oil Rubbed Bronze	DIVERTER HANDLE CAP ORB	185823BN	39.70	Brushed Nickel	T VALVE ESCUTCHEON BN
182637BL	41.55	Matte Black	DIVERTER HANDLE KIT BL	185823NL	39.70	Brushed Nickel	TRANSFER VALVE ESCUTCHEON, NL
182637BN	40.15	Brushed Nickel	DIVERTER HANDLE KIT BN	185823ORB	41.70	Oil Rubbed Bronze	T VALVE ESCUTCHEON ORB
182637ORB	41.55	Oil Rubbed Bronze	DIVERTER HANDLE KIT ORB	185834BN	64.55	Brushed Nickel	MOENTROLESCUTCHEON BN
182843BL	24.25	Matte Black	LIFT ROD KIT, WS, BL	185834NL	64.55	Brushed Nickel	MOENTROLESCUTCHEON, NL
182843BN	22.00	Brushed Nickel	LIFT ROD KIT, WIDESPREAD BN	185834ORB	92.40	Oil Rubbed Bronze	MOENTROLESCUTCHEON ORB
182862BN	89.65	Brushed Nickel	POSI ESCUTCHEON RED/BLUE BN	187053BN	74.35	Brushed Nickel	MAGNETIX DOCKING CRADLE, BN
183196ORB	40.55	Oil Rubbed Bronze	HANDLE KIT ORB	187053ORB	81.45	Oil Rubbed Bronze	MAGNETIX DOCKING CRADLE, ORB
183296SRS	84.70	Spot Resist Stainless	HANDLE KIT SRS	187093BN	72.10	Brushed Nickel	WS HANDLE KIT BN
183297SRS	127.65	Spot Resist Stainless	WAND KIT SRS	187728BLS	92.65	Black/Stainless Steel	WAND KIT BLS
183298SRS	46.35	Spot Resist Stainless	RECEPTOR KIT SRS	187728SRS	55.95	Spot Resist Stainless	WAND KIT SRS
183570BL	55.15	Matte Black	SLIDER KIT FOR ANNEX BL	187729BG	40.35	Brushed Gold	HANDLE KIT, BG
183570BN	53.30	Brushed Nickel	SLIDER KIT FOR ANNEX BN	187729BLS	44.25	Black/Stainless Steel	HANDLE BLS
183570ORB	55.15	Oil Rubbed Bronze	SLIDER KIT FOR ANNEX ORB	187729SRS	39.00	Spot Resist Stainless	HANDLE KIT SRS
183598BL	59.60	Matte Black	HANDLE KIT, BL	188029BL	125.60	Matte Black	WAND KIT, BL
183598BN	34.00	Brushed Nickel	HANDLE KIT, BN	188029SRS	47.85	Spot Resist Stainless	WAND KIT SRS
183810BN	56.05	Matte Black	GENTA POSI HANDLE KIT BN	188030BL	123.65	Matte Black	HANDLE KIT, BL
184081BL	78.55	Matte Black	1H HANDLE KIT BL	188030SRS	38.00	Spot Resist Stainless	HANDLE KIT SRS
184081BN	42.20	Brushed Nickel	1H HANDLE KIT BN	190102BL	74.10	Matte Black	HANDLE KIT, BL
184085BL	183.75	Matte Black	WIDESPREAD SPOUT KIT BL	190102BN	67.35	Brushed Nickel	HANDLE KIT BN
184085BN	101.70	Brushed Nickel	WIDESPREAD SPOUT KIT BN	190102ORB	74.15	Oil Rubbed Bronze	HANDLE KIT ORB
184086BL	256.50	Matte Black	ROMAN TUB SPOUT KIT BL	190112BL	61.65	Matte Black	LIFT ROD, BL
184086BN	230.85	Brushed Nickel	ROMAN TUB SPOUT KIT BN	190112BN	56.10	Brushed Nickel	LIFT ROD BN
184445BG	56.70	Brushed Gold	HANDLE KIT - HOT OR COLD BG	190112ORB	61.65	Oil Rubbed Bronze	LIFT ROD ORB
184445BN	56.70	Brushed Nickel	CENTERSET HANDLE KIT BN	190202BL	87.15	Matte Black	LEVER HANDLE KIT, BL
184445NL	56.70	Brushed Nickel	CENTERSET HANDLE KIT, NL	190202BN	79.30	Brushed Nickel	LEVER HANDLE KIT BN
184445ORB	62.40	Oil Rubbed Bronze	CENTERSET HANDLE KIT ORB	190202ORB	87.15	Oil Rubbed Bronze	LEVER HANDLE KIT ORB
184450BN	55.40	Brushed Nickel	HNDLASSY KIT BN	190322BL	480.00	Matte Black	RT SPOUT KIT, BL
185794BRB	17.45	Mediterranean Bronze	SPOUT HUB KIT, BRB	190322BN	426.70	Brushed Nickel	RT SPOUT KIT BN
185807BN	56.10	Brushed Nickel	1H HANDLE KIT BN	190322ORB	480.00	Oil Rubbed Bronze	RT SPOUT KIT ORB
185807NL	56.10	Brushed Nickel	1H HANDLE KIT, NL	190330SRS	45.70	Spot Resist Stainless	DECK PLATE KIT SRS
185807ORB	59.90	Oil Rubbed Bronze	1H HANDLE KIT ORB	190444BL	48.10	Matte Black	POSI ESCUTCHEON, BL
185808BN	22.20	Brushed Nickel	1H LIFT ROD KIT BN	190444BN	43.65	Brushed Nickel	POSI ESCUTCHEON BN
185808NL	22.20	Brushed Nickel	1H LIFT ROD KIT, NL	190444NL	43.65	Brushed Nickel	POSI ESCUTCHEON, NL
185808ORB	22.90	Oil Rubbed Bronze	1H LIFT ROD KIT ORB	190444ORB	48.10	Oil Rubbed Bronze	POSI ESCUTCHEON ORB
185810BN	54.70	Brushed Nickel	1H ESCUTCHEON BN	190503BL	95.30	Matte Black	SHOWER HANDLE KIT, BL
185810NL	54.70	Brushed Nickel	1H ESCUTCHEON, NL	190503BN	86.70	Brushed Nickel	SHOWER HANDLE KIT BN
185810ORB	57.00	Oil Rubbed Bronze	1H ESCUTCHEON ORB	190503ORB	95.30	Oil Rubbed Bronze	SHOWER HANDLE KIT ORB
185811BN	53.20	Brushed Nickel	CS LEVER HANDLE KIT BN	190844BL	32.90	Matte Black	LIFT ROD KIT BL
185811NL	53.20	Brushed Nickel	CS LEVER HANDLE KIT, NL	190844BN	29.95	Brushed Nickel	LIFT ROD KIT BN
185811ORB	91.15	Oil Rubbed Bronze	CS LEVER HANDLE KIT ORB	190845BL	64.65	Matte Black	HANDLE LEVER KIT BL
185812BN	22.90	Brushed Nickel	CS LIFT ROD KIT BN	190845BN	58.85	Brushed Nickel	HANDLE LEVER KIT BN
185812NL	22.90	Brushed Nickel	CS LIFT ROD KIT, NL	190846BL	90.60	Matte Black	HANDLE KIT HOT BL
185812ORB	24.30	Oil Rubbed Bronze	CS LIFT ROD KIT ORB	190846BN	82.35	Brushed Nickel	HANDLE KIT HOT BN
185813BN	44.25	Brushed Nickel	WS SPOUT CAP BN	190847BL	90.60	Matte Black	HANDLE KIT COLD BL
185813NL	44.25	Brushed Nickel	WS SPOUT KIT, NL	190847BN	82.35	Brushed Nickel	HANDLE KIT COLD BN
185813ORB	45.05	Oil Rubbed Bronze	WS SPOUT CAP ORB	190848BL	425.50	Matte Black	WS SPOUT KIT BL
185814BN	25.50	Brushed Nickel	LIFT ROD KIT BN	190848BN	386.80	Brushed Nickel	WS SPOUT KIT BN
185814NL	25.50	Brushed Nickel	LIFT ROD KIT, NL	190850BL	471.85	Matte Black	3H RT SPOUT KIT BL
185814ORB	26.00	Oil Rubbed Bronze	LIFT ROD KIT ORB	190850BN	429.00	Brushed Nickel	3H RT SPOUT KIT BN
185815BN	61.95	Brushed Nickel	HANDLE KIT BN	190851BL	56.75	Matte Black	DIVERTER LIFT ROD BL
185815NL	63.35	Brushed Nickel	HANDLE KIT, NL	190851BN	51.55	Brushed Nickel	DIVERTER LIFT ROD BN
185815ORB	97.30	Oil Rubbed Bronze	HANDLE KIT ORB	190852BL	758.70	Matte Black	4H RT SPOUT KIT BL
185816BN	205.90	Brushed Nickel	WS SPOUT KIT BN	190852BN	689.75	Brushed Nickel	4H RT SPOUT KIT BN
185816NL	210.55	Brushed Nickel	WS SPOUT KIT, NL	190853BG	64.10	Brushed Gold	ESCUTCHEON BG
185816ORB	213.75	Oil Rubbed Bronze	WS SPOUT KIT ORB	190853BL	70.50	Matte Black	ESCUTCHEON BL
185817BN	357.60	Brushed Nickel	3H RT SPOUT KIT BN	190853BN	64.10	Brushed Nickel	ESCUTCHEON BN
185817NL	357.60	Brushed Nickel	3H RT SPOUT KIT, NL	190853NL	64.10	Brushed Nickel	ESCUTCHEON NL
185817ORB	366.50	Oil Rubbed Bronze	3H RT SPOUT KIT ORB	190854BL	74.65	Matte Black	POSI/MOENTROL ESCUTCHEON BL
185818BN	331.50	Brushed Nickel	4H RT SPOUT KIT BN	190854BN	67.85	Brushed Nickel	POSI/MOENTROL ESCUTCHEON BN
185818NL	331.50	Brushed Nickel	4H RT SPOUT KIT, NL	190856BL	90.95	Matte Black	2FTV ESCUTCHEON BL
185818ORB	346.35	Oil Rubbed Bronze	4H RT SPOUT KIT ORB	190856BN	82.70	Brushed Nickel	2FTV ESCUTCHEON BN
185819BN	29.55	Brushed Nickel	RT DIVERTER LIFT ROD KIT BN	190857BL	78.40	Matte Black	3FTV ESCUTCHEON BL
185819NL	30.20	Brushed Nickel	RT DIVERTER LIFT ROD KIT, NL	190857BN	71.25	Brushed Nickel	3FTV ESCUTCHEON BN
185819ORB	30.40	Oil Rubbed Bronze	RT DIVERTER LIFT ROD KIT ORB	190858BG	88.35	Brushed Gold	HANDLE ESCUTCHEON KIT BG
185821BN	47.80	Brushed Nickel	SHOWER HANDLE KIT BN	190858BL	97.25	Matte Black	HANDLE ESCUTCHEON KIT BL
185821NL	48.90	Brushed Nickel	SHOWER HANDLE KIT, NL				
185821ORB	51.45	Oil Rubbed Bronze	SHOWER HANDLE KIT ORB				

GENUINE PARTS

Moen Genuine Parts

Listed in numerical order

Part Number	List	Finish	Description
190858BN	88.35	Brushed Nickel	HANDLE ESCUTCHEON KIT BN
190858NL	85.35	Brushed Nickel	HANDLE ESCUTCHEON KIT NL
190859BL	113.85	Matte Black	POSI HANDLE KIT BL
190859BN	103.55	Brushed Nickel	POSI HANDLE KIT BN
190860BL	116.55	Matte Black	MOENTROL HANDLE KIT BL
190860BN	106.00	Brushed Nickel	MOENTROL HANDLE KIT BN
190861BL	112.15	Matte Black	2FTV HANDLE KIT BL
190861BN	101.95	Brushed Nickel	2FTV HANDLE KIT BN
190862BL	105.25	Matte Black	3FTV HANDLE KIT BL
190862BN	95.65	Brushed Nickel	3FTV HANDLE KIT BN
190888BL	252.70	Matte Black	SPOUT KIT, BL
191000BL	250.70	Matte Black	ARBOR WAVE FAUCET ASSEMBLY KIT BL
191000ORB	258.95	Spot Resist Stainless	ARBOR WAVE FAUCET ASSEMBLY KIT ORB
191000SRS	236.85	Oil Rubbed Bronze	ARBOR WAVE FAUCET ASSEMBLY KIT SRS
191001BL	251.95	Matte Black	SLEEK WAVE FAUCET ASSEMBLY KIT BL
191001SRS	247.75	Spot Resist Stainless	SLEEK WAVE FAUCET ASSEMBLY KIT SRS
191002BL	321.45	Matte Black	FAUCET ASSEMBLY KIT BL
191002BLS	340.30	Black/Stainless Steel	FAUCET ASSY KIT BLS
191002SRS	309.30	Spot Resist Stainless	ALIGN SPRING WAVE FAUCET ASSEMBLY KIT SR
191004BL	35.00	Matte Black	ARBOR POWER BOOST WAND KIT BL
191004ORB	66.45	Oil Rubbed Bronze	ARBOR POWER BOOST WAND KIT ORB
191004SRS	57.65	Spot Resist Stainless	ARBOR POWER BOOST WAND KIT SRS
191005ORB	66.30	Oil Rubbed Bronze	BRANTFORD POWER BOOST WAND KIT ORB
191005SRS	39.60	Spot Resist Stainless	BRANTFORD POWER BOOST WAND KIT SRS
191751BL	51.60	Matte Black	BLACK PULLDOWN HOSE KIT
193089BG	103.85	Brushed Gold	2FTV ESCUTCHEON KIT BG
193089BL	114.25	Matte Black	2F TRANSFER VALVE ESCUTCHEON, BL
193089BN	103.85	Brushed Nickel	2FTV ESCUTCHEON KIT, BN
193089NL	103.85	Brushed Nickel	2FTV ESCUTCHEON KIT, NL
193089ORB	114.25	Oil Rubbed Bronze	2FTV ESCUTCHEON KIT, ORB
193090BG	111.95	Brushed Gold	POSI HANDLE KIT BG
193090BL	123.15	Matte Black	POSI HANDLE KIT, BL
193090BN	111.95	Brushed Nickel	POSI HANDLE KIT, BN
193090NL	111.95	Brushed Nickel	POSI HANDLE KIT, NL
193090ORB	123.15	Oil Rubbed Bronze	POSI HANDLE KIT, ORB
193091BG	111.95	Brushed Gold	HANDLE ASSEMBLY BG
193091BL	123.15	Matte Black	HANDLE ASSEMBLY, BL
193091BN	111.95	Brushed Nickel	MOENTROL HANDLE KIT, BN
193091NL	111.95	Brushed Nickel	MOENTROL HANDLE KIT, NL
193091ORB	123.75	Oil Rubbed Bronze	MOENTROL HANDLE KIT, ORB
193092BG	112.50	Brushed Gold	2F TRANSFER VALVE HANDLE KIT BG
193092BL	123.80	Matte Black	2F TRANSFER VALVE HANDLE, BL
193092BN	112.50	Brushed Nickel	2F TRANSFER VALVE HANDLE KIT, BN
193092NL	112.50	Brushed Nickel	2F TRANSFER VALVE HANDLE KIT, NL
193092ORB	123.80	Oil Rubbed Bronze	2F TRANSFER VALVE HANDLE KIT, ORB
193093BG	105.55	Brushed Gold	3F TRANSFER VALVE HANDLE KIT BG
193093BL	116.05	Matte Black	3F TRANSFER VALVE HANDLE KIT, BL
193093BN	105.55	Brushed Nickel	3F TRANSFER VALVE HANDLE KIT, BN
193093NL	105.55	Brushed Nickel	3F TRANSFER VALVE HANDLE KIT, NL
193093ORB	116.05	Oil Rubbed Bronze	3F TRANSFER VALVE HANDLE KIT, ORB
193094BL	153.00	Matte Black	SHOWER ESCUTCHEON KIT, BL
193094BN	139.05	Brushed Nickel	SHOWER ESCUTCHEON KIT, BN

Part Number	List	Finish	Description
193095BL	107.75	Matte Black	2FTV ESCUT KIT, BL
193095BN	97.95	Brushed Nickel	2FTV ESCUTCHEON KIT, BN
193096BL	109.45	Matte Black	3F ESCUTCHEON KIT, BL
193096BN	99.45	Brushed Nickel	3FTV ESCUTCHEON KIT, BN
193097BL	91.25	Matte Black	HANDLE HUB ESCUTCHEON, BL
193097BN	82.95	Brushed Nickel	HANDLE HUB ESCUTCHEON KIT, BN
193098BL	97.75	Matte Black	POSI HANDLE KIT, BL
193098BN	88.80	Brushed Nickel	POSI HANDLE KIT, BN
193099BL	101.35	Matte Black	MOENTROL HANDLE KIT, BL
193099BN	92.20	Brushed Nickel	MOENTROL HANDLE KIT, BN
193100BL	98.25	Matte Black	2F TRANSFER VALVE HANDLE, BL
193100BN	89.30	Brushed Nickel	2F TRANSFER VALVE HANDLE KIT, BN
193101BL	91.00	Matte Black	3F TRANSFER VALVE HANDLE KIT, BL
193101BN	82.70	Brushed Nickel	3F TRANSFER VALVE HANDLE KIT, BN
193193BG	165.40	Brushed Gold	DIVERTER KIT BG
193193BN	165.40	Brushed Nickel	DIVERTER KIT BN
193193NL	165.40	Brushed Nickel	DIVERTER KIT NL
193193ORB	181.90	Oil Rubbed Bronze	DIVERTER KIT ORB
193194BG	61.45	Brushed Gold	DIVERTER KNOB KIT BG
193194BN	62.70	Brushed Nickel	DIVERTER KNOB KIT BN
193194NL	62.70	Brushed Nickel	DIVERTER KNOB KIT NL
193194ORB	69.00	Oil Rubbed Bronze	DIVERTER KNOB KIT ORB
193195BG	60.25	Brushed Gold	HANDSHOWER CRADLE KIT BG
193195BN	66.20	Brushed Nickel	HANDSHOWER CRADLE KIT BN
193195ORB	70.30	Oil Rubbed Bronze	HANDSHOWER CRADLE KIT ORB
193196BG	113.40	Brushed Gold	HANDLE KIT BG
193196BN	117.95	Brushed Nickel	HANDLE KIT BN
193196ORB	123.50	Oil Rubbed Bronze	HANDLE KIT ORB
193244BG	116.75	Brushed Gold	EXTMP ESCUTCHEON KIT ALIGN BG
193244BL	128.40	Matte Black	EXTMP ESCUTCHEON KIT ALIGN BL
193244BN	116.75	Brushed Nickel	EXTMP ESCUTCHEON KIT ALIGN BN
193245BG	102.65	Brushed Gold	THERMOSTATIC HDL KIT ALIGN BG
193245BL	112.90	Matte Black	THERMOSTATIC HDL KIT ALIGN BL
193245BN	102.65	Brushed Nickel	THERMOSTATIC HDL KIT ALIGN BN
193246BG	103.65	Brushed Gold	VOLUME HDL KIT ALIGN BG
193246BL	114.00	Matte Black	VOLUME HDL KIT ALIGN BL
193246BN	103.65	Brushed Nickel	VOLUME HDL KIT ALIGN BN
193247BN	100.55	Brushed Nickel	EXTMP ESCUTCHEON KIT BELFIELD BN
193247NL	100.55	Brushed Nickel	EXTMP ESCUTCHEON KIT BELFIELD NL
193247ORB	110.60	Oil Rubbed Bronze	EXTMP ESCUTCHEON KIT BELFIELD ORB
193248BN	100.05	Brushed Nickel	THERMOSTATIC HDL KIT BELFIELD BN
193248NL	100.05	Brushed Nickel	THERMOSTATIC HDL KIT BELFIELD NL
193248ORB	110.05	Oil Rubbed Bronze	THERMOSTATIC HDL KIT BELFIELD ORB
193249BN	101.15	Brushed Nickel	VOLUME HDL KIT BELFIELD BN
193249NL	101.15	Brushed Nickel	VOLUME HDL KIT BELFIELD NL
193249ORB	111.20	Oil Rubbed Bronze	VOLUME HDL KIT BELFIELD ORB
193250BN	191.90	Brushed Nickel	EXTMP ESCUTCHEON KIT WYNFORD BN
193250NL	191.90	Brushed Nickel	EXTMP ESCUTCHEON KIT WYNFORD NL
193250ORB	211.05	Oil Rubbed Bronze	EXTMP ESCUTCHEON KIT WYNFORD ORB
193251BN	103.75	Brushed Nickel	THERMOSTATIC HDL KIT WYNFORD BN

Moen Genuine Parts

Listed in numerical order

Part Number	List	Finish	Description	Part Number	List	Finish	Description
193251NL	103.75	Brushed Nickel	THERMOSTATIC HDL KIT WYNFORD NL	195363NL	111.80	Brushed Nickel	KITCHEN PULLDOWN SPOUT KIT NL
193251ORB	114.10	Oil Rubbed Bronze	THERMOSTATIC HDL KIT WYNFORD ORB	195363ORB	83.45	Oil Rubbed Bronze	KITCHEN PULLDOWN SPOUT KIT ORB
193252BN	105.00	Brushed Nickel	VOLUME HDL KIT WYNFORD BN	195363SRS	78.50	Spot Resist Stainless	KITCHEN PULLDOWN SPOUT KIT SRS
193252NL	105.00	Brushed Nickel	VOLUME HDL KIT WYNFORD NL	195365BG	43.10	Brushed Gold	BAR PULLDOWN SPOUT KIT BG
193252ORB	115.45	Oil Rubbed Bronze	VOLUME HDL KIT WYNFORD ORB	195365BL	74.50	Matte Black	BAR PULLDOWN SPOUT KIT BL
193253BG	129.65	Brushed Gold	EXTMP ESCUTCHEON KIT VOSS BG	195365NL	25.10	Brushed Nickel	BAR PULLDOWN SPOUT KIT NL
193253BN	129.65	Brushed Nickel	EXTMP ESCUTCHEON KIT VOSS BN	195365ORB	20.95	Oil Rubbed Bronze	BAR PULLDOWN SPOUT KIT ORB
193253NL	129.65	Brushed Nickel	EXTMP ESCUTCHEON KIT VOSS NL	195365SRS	19.45	Spot Resist Stainless	BAR PULLDOWN SPOUT KIT SRS
193253ORB	142.65	Oil Rubbed Bronze	EXTMP ESCUTCHEON KIT VOSS ORB	195367BG	76.00	Brushed Gold	FINISHED HANDLE CAP BG
193254BG	101.15	Brushed Gold	THERMOSTATIC HDL KIT VOSS BG	195367BL	30.95	Matte Black	FINISHED HANDLE CAP BL
193254BN	101.15	Brushed Nickel	THERMOSTATIC HDL KIT VOSS BN	195367NL	43.00	Brushed Nickel	FINISHED HANDLE CAP NL
193254NL	101.15	Brushed Nickel	THERMOSTATIC HDL KIT VOSS NL	195367ORB	38.00	Oil Rubbed Bronze	FINISHED HANDLE CAP ORB
193254ORB	111.20	Oil Rubbed Bronze	THERMOSTATIC HDL KIT VOSS ORB	195367SRS	34.75	Spot Resist Stainless	FINISHED HANDLE CAP SRS
193255BG	102.25	Brushed Gold	VOLUME HDL KIT VOSS BG	195369BG	95.05	Brushed Gold	LEVER HANDLE KIT BG
193255BN	102.25	Brushed Nickel	VOLUME HDL KIT VOSS BN	195369BL	38.80	Matte Black	LEVER HANDLE KIT BL
193255NL	102.25	Brushed Nickel	VOLUME HDL KIT VOSS NL	195369NL	44.75	Brushed Nickel	LEVER HANDLE KIT NL
193255ORB	112.45	Oil Rubbed Bronze	VOLUME HDL KIT VOSS ORB	195369ORB	43.30	Oil Rubbed Bronze	LEVER HANDLE KIT ORB
1933SL	31.80	Stainless	ESCT LGD/TC-PSVBSGLMT SL	195369SRS	37.80	Spot Resist Stainless	LEVER HANDLE KIT SRS
193499ORB	331.05	Oil Rubbed Bronze	BRANTFORD WAVE KIT ORB	195370BG	44.65	Brushed Gold	KITCHEN PULLDOWN METAL WAND KIT BG
193499SRS	346.65	Spot Resist Stainless	BRANTFORD WAVE KIT SRS	195370BL	90.00	Matte Black	KITCHEN PULLDOWN METAL WAND KIT BL
194993BL	35.40	Matte Black	VIA PROTRUDED AERATOR SHELL KIT, BL	195370NL	28.15	Brushed Nickel	KITCHEN PULLDOWN METAL WAND KIT NL
194994BL	35.40	Matte Black	RIZON PROTRUDED AERATOR SHELL KIT, BL	195370ORB	24.60	Oil Rubbed Bronze	KITCHEN PULLDOWN METAL WAND KIT ORB
194994BN	33.05	Brushed Nickel	RIZON PROTRUDED AERATOR SHELL KIT, BN	195370SRS	21.65	Spot Resist Stainless	KITCHEN PULLDOWN METAL WAND KIT SRS
194994ORB	35.40	Oil Rubbed Bronze	RIZON/EVA PROTRUDED AERATOR SHELL KIT	195383BG	35.20	Brushed Gold	BAR PULLDOWN METAL WAND KIT BG
194995BN	33.05	Brushed Nickel	PROTRUDED AERATOR SHELL KIT, BN	195383BL	71.70	Matte Black	BAR PULLDOWN METAL WAND KIT BL
194995SRN	33.05	Spot Resist Brushed Nickel	PROTRUDED AERATOR SHELL KIT, SRN	195383NL	25.75	Brushed Nickel	BAR PULLDOWN METAL WAND KIT NL
195173BL	256.30	Matte Black	SPOUT KIT MATTE BLACK	195383ORB	20.80	Oil Rubbed Bronze	BAR PULLDOWN METAL WAND KIT ORB
195173BN	244.45	Brushed Nickel	SPOUT KIT BRUSHED NICKEL	195383SRS	17.75	Spot Resist Stainless	BAR PULLDOWN METAL WAND KIT SRS
195345BG	95.85	Brushed Gold	ET ESCUTCHEON KIT BG	195709BL	85.30	Matte Black	HAND SHOWER CRADLE BL
195345BL	105.40	Matte Black	ET ESCUTCHEON KIT BL	195709BN	77.50	Brushed Nickel	HAND SHOWER CRADLE BN
195345BN	95.85	Brushed Nickel	ET ESCUTCHEON KIT BN	195710BL	124.90	Matte Black	HANDLE KIT BL
195345NL	95.85	Brushed Nickel	ET ESCUTCHEON KIT NL	195710BN	113.55	Brushed Nickel	HANDLE KIT BN
195346BL	144.95	Matte Black	THERMOSTATIC HANDLE KIT BL	195711BL	67.90	Matte Black	DIVERTER KNOB KIT BL
195346BN	131.80	Brushed Nickel	THERMOSTATIC HANDLE KIT BN	195711BN	61.75	Brushed Nickel	DIVERTER KNOB KIT BN
195347BG	72.10	Brushed Gold	ET SHORT RING ESC KIT BG	195712BL	226.50	Matte Black	DIVERTER KIT BL
195347BL	79.30	Matte Black	ET SHORT RING ESC KIT BL	195712BN	205.95	Brushed Nickel	DIVERTER KIT BN
195347BN	72.10	Brushed Nickel	ET SHORT RING ESC KIT BN	196252BN	91.05	Brushed Nickel	LEVER HANDLE KIT BN
195347NL	72.10	Brushed Nickel	ET SHORT RING ESC KIT NL	196252NL	91.05	Brushed Nickel	LEVER HANDLE KIT NL
195349BL	143.50	Matte Black	VOLUME HANDLE KIT BL	196252ORB	100.20	Oil Rubbed Bronze	LEVER HANDLE KIT ORB
195349BN	130.45	Brushed Nickel	VOLUME HANDLE KIT BN	196253BN	112.15	Brushed Nickel	CROSS HANDLE KIT BN
195355BL	109.35	Oil Rubbed Bronze	KITCHEN SPOUT BL	196253NL	112.15	Brushed Nickel	CROSS HANDLE KIT NL
195355SRS	82.80	Spot Resist Stainless	KITCHEN SPOUT SRS	196253ORB	123.45	Oil Rubbed Bronze	CROSS HANDLE KIT ORB
195356BL	45.20	Matte Black	LEVER HANDLE - BL	196267BN	65.00	Brushed Nickel	HANDLE KIT BN
195356SRS	33.40	Spot Resist Stainless	LEVER HANDLE - SRS	196268BN	254.85	Brushed Nickel	SPOUT KIT BN
195357BL	116.75	Matte Black	METAL WAND KIT - BL	196269BN	239.60	Brushed Nickel	SPOUT KIT BN
195357SRS	76.75	Spot Resist Stainless	METAL WAND KIT - SRS	196270BN	541.10	Brushed Nickel	SPOUT KIT BN
195358BL	102.40	Matte Black	WHEEL HANDLE KIT - BL	196271BN	454.85	Brushed Nickel	SPOUT KIT BN
195358SRS	48.30	Spot Resist Stainless	WHEEL HANDLE KIT - SRS	196445BG	72.90	Brushed Gold	HANDSHOWER CRADLE KIT, BG
195359BL	107.20	Matte Black	SPOUT KIT BAR	196445BL	80.30	Matte Black	HANDSHOWER CRADLE KIT, BL
195359SRS	97.15	Spot Resist Stainless	SPOUT KIT BAR	196445BN	72.90	Brushed Nickel	HANDSHOWER CRADLE KIT, BN
195360BL	97.10	Matte Black	METAL BAR WAND KIT - BL	196446BN	66.75	Brushed Nickel	HANDSHOWER CRADLE KIT, BN
195360SRS	63.85	Spot Resist Stainless	METAL BAR WAND KIT - SRS	196447BN	77.60	Oil Rubbed Bronze	HANDSHOWER CRADLE KIT, BN
195362BL	5.45	Matte Black	DECK GASKET BL	196447NL	77.60	Oil Rubbed Bronze	HANDSHOWER CRADLE KIT, NL
195363BG	137.35	Brushed Gold	KITCHEN PULLDOWN SPOUT KIT BG				

Moen Genuine Parts

Listed in numerical order

Part Number	List	Finish	Description
196447ORB	85.40	Oil Rubbed Bronze	HANDSHOWER CRADLE KIT, ORB
196448BN	65.05	Oil Rubbed Bronze	HANDSHOWER CRADLE KIT, BN
196448NL	65.05	Oil Rubbed Bronze	HANDSHOWER CRADLE KIT, NL
196448ORB	71.60	Oil Rubbed Bronze	HANDSHOWER CRADLE KIT, ORB
196449BG	100.35	Brushed Gold	HANDLE KIT, BG
196449BL	110.40	Matte Black	HANDLE KIT, BL
196449BN	100.35	Brushed Nickel	HANDLE KIT, BN
196450BN	103.10	Brushed Nickel	HANDLE KIT, BN
196451BN	114.60	Brushed Nickel	HANDLE KIT, BN
196451NL	114.60	Brushed Nickel	HANDLE KIT, NL
196451ORB	125.85	Oil Rubbed Bronze	HANDLE KIT, ORB
196452BG	50.25	Brushed Gold	DIVERter KNOB KIT, BG
196452BL	55.30	Matte Black	DIVERter KNOB KIT, BL
196452BN	50.25	Brushed Nickel	DIVERter KNOB KIT, BN
196453BG	204.65	Brushed Gold	DIVERter KIT, BG
196453BL	225.10	Matte Black	DIVERter KIT, BL
196453BN	204.65	Brushed Nickel	DIVERter KIT, BN
196454BN	52.70	Chrome	DIVERter KNOB KIT, BN
196455BN	222.35	Brushed Nickel	DIVERter KIT, BN
196456BN	47.95	Brushed Nickel	DIVERter KNOB KIT, BN
196456NL	47.95	Brushed Nickel	DIVERter KNOB KIT, NL
196456ORB	52.75	Oil Rubbed Bronze	DIVERter KNOB KIT, ORB
196457BN	222.60	Brushed Nickel	DIVERter KIT, BN
196457NL	222.60	Brushed Nickel	DIVERter KIT, NL
196457ORB	244.90	Oil Rubbed Bronze	DIVERter KIT, ORB
196458BG	61.40	Brushed Gold	DIVERter KNOB KIT BG
196458BN	51.55	Brushed Nickel	DIVERter KNOB KIT, BN
196458NL	51.55	Brushed Nickel	DIVERter KNOB KIT, NL
196458ORB	56.70	Oil Rubbed Bronze	DIVERter KNOB KIT, ORB
196459BG	224.30	Brushed Gold	DIVERter KIT BG
196459BN	224.85	Brushed Nickel	DIVERter KIT, BN
196459NL	224.85	Brushed Nickel	DIVERter KIT, NL
196459ORB	247.35	Oil Rubbed Bronze	DIVERter KIT, ORB
197583BG	40.55	Brushed Gold	HANDLE LEVER, SCREW & PLUG BG
197583BN	40.55	Brushed Nickel	HANDLE LEVER, SCREW & PLUG BN
197583NL	40.55	Brushed Nickel	HANDLE LEVER, SCREW & PLUG NL
197584BG	31.40	Brushed Gold	WS LIFT ROD KIT BG
197584BN	31.40	Brushed Nickel	WS LIFT ROD KIT BN
197584NL	31.40	Brushed Nickel	WS LIFT ROD KIT NL
197586BG	85.85	Brushed Gold	LEVER HANDLE KIT BG
197586BN	85.85	Brushed Nickel	LEVER HANDLE KIT BN
197586NL	85.85	Brushed Nickel	LEVER HANDLE KIT NL
197587BG	112.15	Brushed Gold	CROSS HANDLE KIT BG
197587BN	112.15	Brushed Nickel	CROSS HANDLE KIT BN
197587NL	112.15	Brushed Nickel	CROSS HANDLE KIT NL
197588BG	435.15	Brushed Gold	RT SPOUT KIT BG
197588BN	435.15	Brushed Nickel	RT SPOUT KIT BN
197588NL	435.15	Brushed Nickel	RT SPOUT KIT NL
197589BG	45.25	Brushed Gold	RT LIFT ROD KIT BG
197589BN	45.25	Brushed Nickel	RT LIFT ROD KIT BN
197589NL	45.25	Brushed Nickel	RT LIFT ROD KIT NL
197590BG	446.45	Brushed Gold	4H RT SPOUT KIT BG
197590BN	446.45	Brushed Nickel	4H RT SPOUT KIT BN
197590NL	446.45	Brushed Nickel	4H RT SPOUT KIT NL
197591BG	103.90	Brushed Gold	SHOWER ESCUTCHEON KIT BG
197591BN	103.90	Brushed Nickel	SHOWER ESCUTCHEON KIT BN
197591NL	103.90	Brushed Nickel	SHOWER ESCUTCHEON KIT NL
197592BG	109.20	Brushed Gold	POSI HANDLE KIT BG
197592BN	109.20	Brushed Nickel	POSI HANDLE KIT BN
197592NL	109.20	Brushed Nickel	POSI HANDLE KIT NL
197593BG	111.05	Brushed Gold	MOENTROL HANDLE KIT BG
197593BN	111.05	Brushed Nickel	MOENTROL HANDLE KIT BN
197593NL	111.05	Brushed Nickel	MOENTROL HANDLE KIT NL

Part Number	List	Finish	Description
197594BG	132.15	Brushed Gold	THERMOSTATIC HANDLE KIT BG
197594BN	132.15	Brushed Nickel	THERMOSTATIC HANDLE KIT BN
197594NL	132.15	Brushed Nickel	THERMOSTATIC HANDLE KIT NL
197595BG	130.85	Brushed Gold	VOLUME HANDLE KIT BG
197595BN	130.85	Brushed Nickel	VOLUME HANDLE KIT BN
197595NL	130.85	Brushed Nickel	VOLUME HANDLE KIT NL
197596BG	73.30	Brushed Gold	2/3FTV ESCUTCHEON BG
197596BN	73.30	Brushed Nickel	2/3FTV ESCUTCHEON BN
197596NL	73.30	Brushed Nickel	2/3FTV ESCUTCHEON NL
197597BG	107.75	Brushed Gold	2/3FTV HANDLE ASSEMBLY BG
197597NL	107.75	Brushed Nickel	2/3FTV HANDLE ASSEMBLY NL
197598BN	73.80	Brushed Nickel	3FTV ESCUTCHEON BN
197599BG	101.35	Brushed Gold	3FTV HANDLE ASSEMBLY BG
197599BN	101.35	Brushed Nickel	3FTV HANDLE ASSEMBLY BN
197599NL	101.35	Brushed Nickel	3FTV HANDLE ASSEMBLY NL
197600BG	87.90	Brushed Gold	HANDSHOWER CRADLE KIT BG
197600BN	87.90	Brushed Nickel	HANDSHOWER CRADLE KIT BN
197600NL	87.90	Brushed Nickel	HANDSHOWER CRADLE KIT NL
197601BG	111.10	Brushed Gold	TUB FILLER HANDLE KIT BG
197601BN	111.10	Brushed Nickel	TUB FILLER HANDLE KIT BN
197601NL	111.10	Brushed Nickel	TUB FILLER HANDLE KIT NL
197869BL	413.60	Matte Black	SPOUT KIT BL
197869SRS	431.35	Spot Resist Stainless	SPOUT KIT SRS
197870BL	431.75	Black	SPOUT KIT BL
197870SRS	445.40	Spot Resist Stainless	SPOUT KIT SRS
197872BL	35.60	Matte Black	HANDLE KIT BL
197872BLBG	139.65	Matte Black/Brushed Gold	HANDLE KIT, BL/BG
197872BLSSRS	139.65	Matte Black/SpResStainless	HANDLE KIT, BL/SRS
197872CHBL	113.05	Chrome/Matte Black	HANDLE KIT, CHR/BL
197872SRS	45.75	Spot Resist Stainless	HANDLE KIT SRS
197872SRSBL	118.20	SpResist Stainless/MatteBlack	HANDLE KIT, SRS/BL
197883BG	286.20	Brushed Gold	SWING ARM ASSY BG
197883BL	234.80	Matte Black	SWING ARM AND DOCKING COLLAR KIT
197883NL	351.95	Brushed Nickel	SWING ARM ASSY NL
197883ORB	299.75	Oil Rubbed Bronze	SWING ARM ASSY ORB
197883SRS	217.85	Spot Resist Stainless	SWING ARM AND DOCKING COLLAR KIT
197884BG	144.80	Brushed Gold	SPRING & DOCKING COLLAR BG
197884BL	161.40	Matte Black	SPRING & DOCKING COLLAR BL
197884NL	144.80	Brushed Nickel	SPRING & DOCKING COLLAR NL
197884ORB	173.70	Oil Rubbed Bronze	SPRING & DOCKING COLLAR ORB
197884SRS	98.50	Spot Resist Stainless	SPRING & DOCKING COLLAR SRS
197931BL	171.75	Matte Black	ESCUTCHEON BL
197931BN	161.75	Brushed Nickel	ESCUTCHEON BN
197932BG	131.45	Brushed Gold	ESCUTCHEON BG
197932BL	139.60	Matte Black	ESCUTCHEON BL
197932BN	131.45	Brushed Nickel	ESCUTCHEON BN
197933BN	165.95	Brushed Nickel	ESCUTCHEON BN
197934BN	114.70	Brushed Nickel	ESCUTCHEON BN
197934NL	114.70	Brushed Nickel	ESCUTCHEON NL
197934ORB	126.15	Oil Rubbed Bronze	ESCUTCHEON ORB
197935BG	124.30	Brushed Gold	ESCUTCHEON BG
197935BN	124.30	Brushed Nickel	ESCUTCHEON BN
197935NL	124.30	Brushed Nickel	ESCUTCHEON NL
197935ORB	136.80	Oil Rubbed Bronze	ESCUTCHEON ORB
197936BN	131.25	Brushed Nickel	ESCUTCHEON BN
197936NL	131.25	Brushed Nickel	ESCUTCHEON NL
197936ORB	144.35	Oil Rubbed Bronze	ESCUTCHEON ORB
197937BN	158.40	Brushed Nickel	ESCUTCHEON BN
197939BL	173.55	Matte Black	ESCUTCHEON BL

Moen Genuine Parts

Listed in numerical order

Part Number	List	Finish	Description	Part Number	List	Finish	Description
197939BN	163.40	Brushed Nickel	ESCUTCHEON BN	198040BL	80.85	Matte Black	HANDLE HUB ESCUTCHEON KIT, BL
197940BG	163.40	Brushed Gold	ESCUTCHEON BG	198040BN	73.55	Brushed Nickel	HANDLE HUB ESCUTCHEON KIT, BN
197940BL	1353.55	Matte Black	ESCUTCHEON BL	198040NL	73.55	Brushed Nickel	HANDLE HUB ESCUTCHEON KIT, NL
197940BN	163.40	Brushed Nickel	ESCUTCHEON BN	198040ORB	80.85	Oil Rubbed Bronze	HANDLE HUB ESCUTCHEON KIT, ORB
197940NL	163.40	Brushed Nickel	ESCUTCHEON NL	198107BL	30.40	Matte Black	TWO PIECE LIFT ROD KIT, BL
197940ORB	173.55	Oil Rubbed Bronze	ESCUTCHEON ORB	198107BN	33.45	Brushed Nickel	TWO PIECE LIFT ROD KIT, BN
197941BL	125.00	Matte Black	ESCUTCHEON BL	198279BLS	180.70	Black Stainless	WAND KIT BLS
197941BN	117.65	Brushed Nickel	ESCUTCHEON BN	198279ORB	180.55	Oil Rubbed Bronze	WAND KIT, ORB
197942BL	45.15	Matte Black	HANDLE BL	198279SRS	121.20	Spot Resist Stainless	WAND KIT SRS
197942BN	42.60	Brushed Nickel	HANDLE BN	198280BL	151.75	Matte Black	WAND KIT BL
197943BG	37.50	Brushed Gold	HANDLE BG	198280SRS	124.00	Spot Resist Stainless	WAND KIT SRS
197943BL	39.85	Matte Black	HANDLE BL	198288BL	189.20	Matte Black	SPOUT KIT BL
197943BN	37.50	Brushed Nickel	HANDLE BN	198288SRS	96.60	Spot Resist Stainless	SPOUT KIT SRS
197944BL	43.95	Matte Black	HANDLE BL	198289BL	50.90	Matte Black	HANDLE KIT BL
197944BN	41.30	Brushed Nickel	HANDLE BN	198289SRS	27.65	Spot Resist Stainless	HANDLE KIT SRS
197945BN	40.70	Chrome	HANDLE BN	198880ORB	87.85	Oil Rubbed Bronze	2H KITCHEN H/C HANDLE ORB
197945NL	40.70	Brushed Nickel	HANDLE NL	198880SRS	58.65	Spot Resist Stainless	2H KITCHEN H/C HANDLESRS
197945ORB	43.20	Brushed Nickel	HANDLE ORB	198881ORB	95.30	Oil Rubbed Bronze	ESC KIT ORB
197946BG	42.10	Brushed Gold	HANDLE BG	198881SRS	54.20	Spot Resist Stainless	ESC KIT SRS
197946BN	42.10	Brushed Nickel	HANDLE BN	198921BL	93.25	Matte Black	WAND KIT, BL
197946NL	42.10	Brushed Nickel	HANDLE NL	198921BLS	133.35	Black/Stainless Steel	WAND KIT, BLS
197946ORB	44.65	Oil Rubbed Bronze	HANDLE ORB	198921ORB	121.60	Oil Rubbed Bronze	WAND KIT, ORB
197947BN	46.20	Brushed Nickel	HANDLE BN	198921SRS	103.85	Spot Resist Stainless	WAND KIT, SRS
197947NL	46.20	Brushed Nickel	HANDLE NL	198922BL	185.65	Matte Black	SPOUT KIT, BL
197947ORB	49.10	Oil Rubbed Bronze	HANDLE ORB	198923BL	101.95	Matte Black	HANDLE KIT, BL
197948BN	50.45	Brushed Nickel	HANDLE BN	198923SRS	73.70	Spot Resist Stainless	HANDLE KIT, SRS
197949BL	49.50	Matte Black	HANDLE BL	199097BL	133.00	Matte Black	SPRING & BEARING KIT BL
197949BN	46.60	Brushed Nickel	HANDLE BN	199097BLS	202.70	Black/Stainless Steel	SPRING & BEARING KIT SRS
197950BG	50.05	Brushed Gold	HANDLE HUB BG	199097SRS	101.15	Spot Resist Stainless	SPRING & BEARING KIT SRS
197950BL	53.20	Matte Black	HANDLE HUB BL	199098BL	128.35	Matte Black	SWINGARM & COLLAR KIT BL
197950BN	50.05	Brushed Nickel	HANDLE HUB BN	199098BLS	237.70	Black/Stainless Steel	SWINGARM & COLLAR KIT BLS
197950NL	50.05	Brushed Nickel	HANDLE HUB NL	199098SRS	109.00	Spot Resist Stainless	SWINGARM & COLLAR KIT SRS
197950ORB	53.20	Oil Rubbed Bronze	HANDLE HUB ORB	199106BL	50.50	Matte Black	REFLEX HOSE KIT, BL
197951BG	43.75	Brushed Gold	HANDLE BG	199477SRN	295.65	Spot Resist Brushed Nickel	NON DIVERTING RT SPOUT KIT SRN
197951BL	46.45	Matte Black	HANDLE BL	199490BL	351.90	Matte Black	ROMAN TUB SPOUT BL
197951BN	43.75	Brushed Nickel	HANDLE BN	199490BN	415.55	Brushed Nickel	ROMAN TUB SPOUT BN
197951NL	43.75	Brushed Nickel	HANDLE NL	200001BN	559.60	Brushed Nickel	ARRIS SPOUT BN
197951ORB	46.45	Oil Rubbed Bronze	HANDLE ORB	200014BG	98.05	Brushed Gold	WAND KIT
197952BL	42.30	Matte Black	HANDLE BL	200014BL	75.00	Matte Black	WAND KIT BL
197952BN	39.80	Brushed Nickel	HANDLE BN	200014BLS	86.60	Black Stainless	WAND KIT BLS
198018BL	54.95	Matte Black	SLIDER BL	200014SRS	75.00	Spot Resist Stainless	WAND KIT SRS
198018BN	51.75	Brushed Nickel	SLIDER BN	200101BN	0.40	Brushed Nickel	PLUG BUTTON KIT, BN
198019BL	13.30	Matte Black	PLUG BUTTON BL	200714BN	38.90	Brushed Nickel	HANDLE KIT, BN
198019BN	12.55	Brushed Nickel	PLUG BUTTON BN	200714ORB	42.80	Oil Rubbed Bronze	HANDLE KIT, ORB
198027BL	45.00	Matte Black	DIVERTER VALVE ESCUT, BL	200715BN	55.05	Brushed Nickel	M-CORE DIVERTER ESCUTCHEON KIT, BN
198027BN	40.90	Brushed Nickel	DIVERTER VALVE ESCUT, BN	200715ORB	67.05	Oil Rubbed Bronze	M-CORE DIVERTER ESCUTCHEON KIT, ORB
198027ORB	44.20	Oil Rubbed Bronze	DIVERTER VALVE ESCUT, ORB	200716BN	41.10	Brushed Nickel	HANDLE KIT, BN
198029BN	73.40	Brushed Nickel	DIVERTER VALVE ESCUT, BN	200716ORB	45.20	Oil Rubbed Bronze	HANDLE KIT, ORB
198031BL	72.55	Matte Black	DIVERTER WALL ESCUTCHEON, BL	200717BN	59.75	Brushed Nickel	M-CORE DIVERTER ESCUTCHEON KIT, BN
198031BN	69.60	Brushed Nickel	DIVERTER VALVE ESCUT, BN	200717ORB	72.35	Oil Rubbed Bronze	M-CORE DIVERTER ESCUTCHEON KIT, ORB
198032BL	73.80	Matte Black	DIVERTER WALL ESCUTCHEON, BL	200718BL	47.10	Matte Black	HANDLE KIT, BL
198032BN	59.35	Brushed Nickel	DIVERTER VALVE ESCUT, BN	200718BN	42.80	Brushed Nickel	HANDLE KIT, BN
198033BG	61.20	Brushed Gold	DIVERTER VALVE ESCUT BG	200718ORB	47.10	Oil Rubbed Bronze	HANDLE KIT, ORB
198033BN	61.20	Brushed Nickel	DIVERTER VALVE ESCUT, BN	200719BN	59.75	Brushed Nickel	M-CORE DIVERTER ESCUTCHEON KIT, BN
198033NL	61.20	Brushed Nickel	DIVERTER VALVE ESCUT, NL	200720BRB	54.35	Mediterranean Bronze	HANDLE KIT, BRB
198033ORB	67.35	Oil Rubbed Bronze	DIVERTER VALVE ESCUT, ORB	200720SRN	49.40	Spot Resist Brushed Nickel	HANDLE KIT, SRN
198036BG	101.20	Brushed Gold	3FTV ESCUTCHEON KIT BG	200721BRB	160.30	Mediterranean Bronze	M-CORE DIVERTER ESCUTCHEON KIT, BRB
198036BL	111.40	Matte Black	3FTV ESCUTCHEON KIT, BL	200721SRN	115.85	Spot Resist Brushed Nickel	M-CORE DIVERTER ESCUTCHEON KIT, SRN
198036BN	101.20	Brushed Nickel	3FTV ESCUTCHEON KIT, BN	200722BL	42.70	Matte Black	HANDLE KIT, BL
198036NL	101.20	Brushed Nickel	3FTV ESCUTCHEON KIT, NL	200722BN	38.80	Brushed Nickel	HANDLE KIT, BN
198036ORB	111.40	Oil Rubbed Bronze	3FTV ESCUTCHEON KIT, ORB				
198038BG	133.35	Brushed Gold	ESCUTCHEON KIT BG				
198038BL	146.70	Matte Black	MOENTROL ESCUTCHEON KIT, BL				
198038BN	133.35	Brushed Nickel	SHOWER ESCUTCHEON KIT, BN				
198038NL	133.35	Brushed Nickel	SHOWER ESCUTCHEON KIT, NL				
198038ORB	146.70	Oil Rubbed Bronze	SHOWER ESCUTCHEON KIT, ORB				
198040BG	73.55	Brushed Gold	HANDLE ESCUTCHEON KIT BG				

Moen Genuine Parts

Listed in numerical order

Part Number	List	Finish	Description	Part Number	List	Finish	Description
200723BL	66.10	Matte Black	M-CORE DIVERTER ESCUTCHEON KIT, BL	200743ORB	46.40	Oil Rubbed Bronze	M-CORE DIVERTER ESCUTCHEON KIT KIT, ORB
200723BN	55.05	Brushed Nickel	M-CORE DIVERTER ESCUTCHEON KIT, BN	200744BN	38.40	Brushed Nickel	HANDLE KIT, BN
200724BL	43.05	Matte Black	HANDLE KIT, BL	200745BN	41.30	Brushed Nickel	M-CORE DIVERTER ESCUTCHEON KIT, BN
200724BN	39.15	Brushed Nickel	HANDLE KIT, BN	200746BG	46.05	Brushed Gold	HANDLE KIT, BG
200726BL	45.20	Matte Black	HANDLE KIT, BL	200746BN	46.05	Brushed Nickel	HANDLE KIT, BN
200726BN	40.05	Brushed Nickel	HANDLE KIT, BN	200746NL	46.05	Brushed Nickel	HANDLE KIT, NL
200727BL	52.85	Matte Black	M-CORE DIVERTER ESCUTCHEON KIT, BL	200747BG	39.70	Brushed Gold	M-CORE DIVERTER ESCUTCHEON KIT KIT, BG
200727BN	52.40	Brushed Nickel	M-CORE DIVERTER ESCUTCHEON KIT KIT, BN	200747BN	39.70	Brushed Nickel	M-CORE DIVERTER ESCUTCHEON KIT KIT, BN
200728BL	42.25	Matte Black	HANDLE KIT, BL	200747NL	39.70	Brushed Nickel	M-CORE DIVERTER ESCUTCHEON KIT KIT, NL
200728BN	38.40	Brushed Nickel	HANDLE KIT, BN	200748BL	41.85	Matte Black	HANDLE KIT, BL
200729BL	57.90	Matte Black	M-CORE DIVERTER ESCUTCHEON KIT KIT, BL	200748BN	38.10	Brushed Nickel	HANDLE KIT, BN
200729BN	51.80	Brushed Nickel	M-CORE DIVERTER ESCUTCHEON KIT KIT, BN	200749BL	45.20	Matte Black	M-CORE DIVERTER ESCUTCHEON KIT, BL
200730BG	29.75	Brushed Gold	HANDLE KIT, BG	200749BN	41.10	Brushed Nickel	M-CORE DIVERTER ESCUTCHEON KIT, BN
200730BL	32.80	Matte Black	HANDLE KIT, BL	200750BG	40.55	Brushed Gold	HANDLE KIT, BG
200730BN	29.75	Brushed Nickel	HANDLE KIT, BN	200750BL	44.55	Matte Black	HANDLE KIT, BL
200731BG	34.30	Brushed Gold	M-CORE DIVERTER ESCUTCHEON KIT KIT, BG	200750BN	40.55	Brushed Nickel	HANDLE KIT, BN
200731BL	37.75	Matte Black	M-CORE DIVERTER ESCUTCHEON KIT KIT, BL	200775BG	19.40	Brushed Gold	M-CORE SLEEVE KIT, ROUND MODERN, BG
200731BN	34.30	Brushed Nickel	M-CORE DIVERTER ESCUTCHEON KIT KIT, BN	200775BL	21.35	Matte Black	M-CORE SLEEVE KIT, ROUND MODERN, BL
200732BN	46.70	Brushed Nickel	HANDLE KIT, BN	200775BN	19.40	Brushed Nickel	M-CORE SLEEVE KIT, ROUND MODERN, BN
200732NL	46.70	Brushed Nickel	HANDLE KIT, NL	200775NL	19.40	Brushed Nickel	M-CORE SLEEVE KIT, ROUND MODERN, NL
200732ORB	51.45	Oil Rubbed Bronze	HANDLE KIT, ORB	200775ORB	20.65	Oil Rubbed Bronze	M-CORE SLEEVE KIT, ROUND MODERN, ORB
200733BL	52.85	Matte Black	M-CORE DIVERTER ESCUTCHEON KIT, BL	200776BC	18.75	Brushed Chrome	M-CORE SLEEVE KIT, ROUND TRADITIONAL, BC
200733BN	46.85	Brushed Nickel	M-CORE DIVERTER ESCUTCHEON KIT KIT, SL	200776BG	17.80	Brushed Gold	M-CORE SLEEVE KIT, ROUND TRADITIONAL, BG
200733NL	46.85	Brushed Nickel	M-CORE DIVERTER ESCUTCHEON KIT KIT, NL	200776BL	19.50	Matte Black	M-CORE SLEEVE KIT, ROUND TRADITIONAL, BL
200733ORB	52.85	Oil Rubbed Bronze	M-CORE DIVERTER ESCUTCHEON KIT KIT, ORB	200776BN	17.80	Brushed Nickel	M-CORE SLEEVE KIT, ROUND TRADITIONAL, BN
200734BN	42.70	Brushed Nickel	HANDLE KIT, BN	200776NL	17.80	Brushed Nickel	M-CORE SLEEVE KIT, ROUND TRADITIONAL, NL
200734NL	42.70	Brushed Nickel	HANDLE KIT, NL	200776ORB	19.50	Oil Rubbed Bronze	M-CORE SLEEVE KIT, ROUND TRADITIONAL, ORB
200734ORB	46.95	Oil Rubbed Bronze	HANDLE KIT, ORB	200777BN	20.30	Brushed Nickel	M-CORE SLEEVE KIT, SQUARE, BN
200735BN	48.00	Brushed Nickel	M-CORE DIVERTER ESCUTCHEON KIT KIT, SL	200778BG	20.30	Brushed Gold	M-CORE SLEEVE KIT, VOSS, BG
200735NL	48.00	Brushed Nickel	M-CORE DIVERTER ESCUTCHEON KIT KIT, NL	200778BN	20.30	Brushed Nickel	M-CORE SLEEVE KIT, VOSS, BN
200735ORB	52.85	Oil Rubbed Bronze	M-CORE DIVERTER ESCUTCHEON KIT KIT, ORB	200778NL	20.30	Brushed Nickel	M-CORE SLEEVE KIT, VOSS, NL
200736BG	48.10	Brushed Gold	HANDLE KIT, BG	200778ORB	22.40	Oil Rubbed Bronze	M-CORE SLEEVE KIT, VOSS, ORB
200736BN	48.10	Brushed Nickel	HANDLE KIT, BN	200782BG	36.25	Brushed Gold	M-CORE HANDLE KIT, BG
200736NL	48.10	Brushed Nickel	HANDLE KIT, NL	200782BL	39.80	Matte Black	M-CORE HANDLE KIT, BL
200736ORB	52.95	Oil Rubbed Bronze	HANDLE KIT, ORB	200782BN	36.25	Brushed Nickel	M-CORE HANDLE KIT, BN
200737BG	50.05	Brushed Gold	M-CORE DIVERTER ESCUTCHEON KIT KIT, BG	200783BG	71.20	Brushed Gold	M-CORE ESCUTCHEON KIT, BG
200737BN	50.05	Brushed Nickel	M-CORE DIVERTER ESCUTCHEON KIT KIT, SL	200783BL	78.40	Matte Black	M-CORE ESCUTCHEON KIT, BL
200737NL	50.05	Brushed Nickel	M-CORE DIVERTER ESCUTCHEON KIT KIT, NL	200783BN	71.20	Brushed Nickel	M-CORE ESCUTCHEON KIT, BN
200737ORB	55.05	Oil Rubbed Bronze	M-CORE DIVERTER ESCUTCHEON KIT KIT, ORB	200783CBN	71.25	Classic Brushed Nickel	M-CORE ESCUTCHEON KIT, CBN
200740BL	44.55	Matte Black	HANDLE KIT, BL	200784BN	57.35	Brushed Nickel	M-CORE HANDLE KIT, BN
200740BN	40.55	Brushed Nickel	HANDLE KIT, BN	200784NL	57.35	Brushed Nickel	M-CORE HANDLE KIT, NL
200741BL	68.80	Matte Black	M-CORE DIVERTER ESCUTCHEON KIT KIT, BL	200784ORB	63.10	Oil Rubbed Bronze	M-CORE HANDLE KIT, ORB
200741BN	62.55	Brushed Nickel	M-CORE DIVERTER ESCUTCHEON KIT KIT, BN	200785BN	70.30	Brushed Nickel	M-CORE ESCUTCHEON KIT, BN
200742BG	44.10	Brushed Gold	HANDLE KIT, BG	200785NL	70.30	Brushed Nickel	M-CORE ESCUTCHEON KIT, NL
200742BL	48.45	Matte Black	HANDLE KIT, BL	200785ORB	77.35	Oil Rubbed Bronze	M-CORE ESCUTCHEON KIT, ORB
200742BN	44.10	Brushed Nickel	HANDLE KIT, BN	200786BG	40.75	Brushed Gold	M-CORE HANDLE KIT, BG
200742NL	44.10	Brushed Nickel	HANDLE KIT, NL	200786BN	40.75	Brushed Nickel	M-CORE HANDLE KIT, BN
200742ORB	48.45	Oil Rubbed Bronze	HANDLE KIT, ORB	200786NL	40.75	Brushed Nickel	M-CORE HANDLE KIT, NL
200743BG	42.15	Brushed Gold	M-CORE DIVERTER ESCUTCHEON KIT KIT, BG	200786ORB	44.75	Oil Rubbed Bronze	M-CORE HANDLE KIT, ORB
200743BL	46.40	Matte Black	M-CORE DIVERTER ESCUTCHEON KIT KIT, BL				
200743BN	42.15	Brushed Nickel	M-CORE DIVERTER ESCUTCHEON KIT KIT, BN				
200743NL	42.15	Brushed Nickel	M-CORE DIVERTER ESCUTCHEON KIT KIT, NL				

Moen Genuine Parts

Listed in numerical order

Part Number	List	Finish	Description	Part Number	List	Finish	Description
200787BG	47.55	Brushed Gold	M-CORE ESCUTCHEON KIT, BG	200810BN	116.70	Brushed Nickel	M-CORE ESCUTCHEON KIT, BN
200787BN	47.55	Brushed Nickel	M-CORE ESCUTCHEON KIT, BN	200810NL	116.70	Brushed Nickel	M-CORE ESCUTCHEON KIT, NL
200787NL	47.55	Brushed Nickel	M-CORE ESCUTCHEON KIT, NL	200810ORB	128.35	Oil Rubbed Bronze	M-CORE ESCUTCHEON KIT, ORB
200787ORB	52.30	Oil Rubbed Bronze	M-CORE ESCUTCHEON KIT, ORB	200811BG	60.70	Brushed Gold	M-CORE ESCUTCHEON KIT, BG
200788BN	42.70	Brushed Nickel	M-CORE HANDLE KIT, BN	200811BN	60.70	Brushed Nickel	M-CORE ESCUTCHEON KIT, BN
200788NL	42.70	Brushed Nickel	M-CORE HANDLE KIT, NL	200811NL	60.70	Brushed Nickel	M-CORE ESCUTCHEON KIT, NL
200788ORB	46.95	Oil Rubbed Bronze	M-CORE HANDLE KIT, ORB	200811ORB	66.85	Oil Rubbed Bronze	M-CORE ESCUTCHEON KIT, ORB
200789BN	64.15	Brushed Nickel	M-CORE ESCUTCHEON KIT, BN	200812BN	122.00	Brushed Nickel	M-CORE ESCUTCHEON KIT, BN
200789NL	64.15	Brushed Nickel	M-CORE ESCUTCHEON KIT, NL	200812NL	122.00	Brushed Nickel	M-CORE ESCUTCHEON KIT, NL
200789ORB	70.65	Oil Rubbed Bronze	M-CORE ESCUTCHEON KIT, ORB	200812ORB	134.20	Oil Rubbed Bronze	M-CORE ESCUTCHEON KIT, ORB
200790CBN	58.05	Classic Brushed Nickel	M-CORE HANDLE KIT, CBN	200813BG	159.15	Brushed Gold	M-CORE ESCUTCHEON KIT, BG
200791BC	42.80	Brushed Chrome	HANDLE, BC	200813BN	159.15	Brushed Nickel	M-CORE ESCUTCHEON KIT, BN
200792BL	47.90	Matte Black	M-CORE HANDLE KIT, BL	200813NL	159.15	Brushed Nickel	M-CORE ESCUTCHEON KIT, NL
200792BN	43.50	Brushed Nickel	M-CORE HANDLE KIT, BN	200814BL	143.00	Matte Black	M-CORE ESCUTCHEON KIT, BL
200793BL	95.55	Matte Black	M-CORE ESCUTCHEON KIT, BL	200814BN	129.95	Brushed Nickel	M-CORE ESCUTCHEON KIT, BN
200793BN	86.90	Brushed Nickel	M-CORE ESCUTCHEON KIT, BN	200816BL	112.40	Matte Black	M-CORE ESCUTCHEON KIT, BL
200794BL	44.00	Matte Black	M-CORE HANDLE KIT, BL	200816BN	102.15	Brushed Nickel	M-CORE ESCUTCHEON KIT, BN
200794BN	39.90	Brushed Nickel	M-CORE HANDLE KIT, BN	200817BG	153.50	Brushed Gold	M-CORE ESCUTCHEON KIT, BG
200795BL	70.65	Matte Black	M-CORE ESCUTCHEON KIT, BL	200817BL	168.80	Matte Black	M-CORE ESCUTCHEON KIT, BL
200795BN	64.15	Brushed Nickel	M-CORE ESCUTCHEON KIT, BN	200817BN	153.50	Brushed Nickel	M-CORE ESCUTCHEON KIT, BN
200796BG	58.85	Brushed Gold	M-CORE HANDLE KIT, BG	200817NL	153.50	Brushed Nickel	M-CORE ESCUTCHEON KIT, NL
200796BL	64.75	Matte Black	M-CORE HANDLE KIT, BL	200817ORB	168.80	Oil Rubbed Bronze	M-CORE ESCUTCHEON KIT, ORB
200796BN	58.85	Brushed Nickel	M-CORE HANDLE KIT, BN	200818BN	58.25	Brushed Nickel	M-CORE ESCUTCHEON KIT, BN
200796NL	58.85	Brushed Nickel	M-CORE HANDLE KIT, NL	200819BG	96.20	Brushed Gold	M-CORE ESCUTCHEON KIT, BG
200796ORB	64.75	Oil Rubbed Bronze	M-CORE HANDLE KIT, ORB	200819BL	105.80	Matte Black	M-CORE ESCUTCHEON KIT, BL
200797BG	86.80	Brushed Gold	M-CORE ESCUTCHEON KIT, BG	200819BN	96.20	Brushed Nickel	M-CORE ESCUTCHEON KIT, BN
200797BL	95.45	Matte Black	M-CORE ESCUTCHEON KIT, BL	200820BG	47.20	Brushed Gold	M-CORE HANDLE HUB KIT, BG
200797BN	86.80	Brushed Nickel	M-CORE ESCUTCHEON KIT, BN	200820BN	47.20	Brushed Nickel	M-CORE HANDLE HUB KIT, BN
200797NL	86.80	Brushed Nickel	M-CORE ESCUTCHEON KIT, NL	200820NL	47.20	Brushed Nickel	M-CORE HANDLE HUB KIT, NL
200797ORB	95.45	Oil Rubbed Bronze	M-CORE ESCUTCHEON KIT, ORB	200820ORB	51.90	Oil Rubbed Bronze	M-CORE HANDLE HUB KIT, ORB
200798BN	37.95	Brushed Nickel	M-CORE HANDLE KIT, BN	200821BN	47.65	Brushed Nickel	M-CORE HANDLE HUB KIT, BN
200799BN	55.65	Brushed Nickel	M-CORE ESCUTCHEON KIT, BN	201203BG	93.60	Brushed Gold	COLINET LVR HDL KIT BG
200800BG	38.65	Brushed Gold	M-CORE HANDLE KIT, BG	201203BL	102.90	Matte Black	COLINET LVR HDL KIT BL
200800BL	42.60	Matte Black	M-CORE HANDLE KIT, BL	201203BN	93.60	Brushed Nickel	COLINET LVR HDL KIT BN
200800BN	38.65	Brushed Nickel	M-CORE HANDLE KIT, BN	201204BG	94.10	Brushed Gold	COLINET CROSS HDL KIT BG
200801BG	80.90	Brushed Gold	M-CORE ESCUTCHEON KIT, BG	201204BL	103.55	Matte Black	COLINET CROSS HDL KIT BL
200801BL	89.00	Matte Black	M-CORE ESCUTCHEON KIT, BL	201204BN	94.10	Brushed Nickel	COLINET CROSS HDL KIT BN
200801BN	80.90	Brushed Nickel	M-CORE ESCUTCHEON KIT, BN	201205BG	308.35	Brushed Gold	COLINET WLMT LAVSPT KIT BG
200802BG	42.80	Brushed Gold	M-CORE HANDLE KIT, BG	201205BL	339.25	Matte Black	COLINET WLMT LAVSPT KIT BL
200802BN	42.80	Brushed Nickel	M-CORE HANDLE KIT, BN	201205BN	308.35	Brushed Nickel	COLINET WLMT LAVSPT KIT BN
200802NL	42.80	Brushed Nickel	M-CORE HANDLE KIT, NL	201206BG	67.40	Brushed Gold	WSLIFT ROD KIT BG
200803BG	86.80	Brushed Gold	M-CORE ESCUTCHEON KIT, BG	201206BL	74.15	Matte Black	WSLIFT ROD KIT BL
200803BN	86.80	Brushed Nickel	M-CORE ESCUTCHEON KIT, BN	201206BN	67.40	Brushed Nickel	WSLIFT ROD KIT BN
200803NL	86.80	Brushed Nickel	M-CORE ESCUTCHEON KIT, NL	201208BG	588.15	Brushed Gold	RT SPOUT KIT BG
200806BL	51.90	Matte Black	M-CORE HANDLE KIT, BL	201208BL	647.00	Matte Black	RT SPOUT KIT BL
200806BN	47.20	Brushed Nickel	M-CORE HANDLE KIT, BN	201208BN	588.15	Brushed Nickel	RT SPOUT KIT BN
200807BL	107.65	Matte Black	M-CORE ESCUTCHEON KIT, BL	201209BG	637.95	Brushed Gold	4H RT SPOUT KIT BG
200807BN	97.85	Brushed Nickel	M-CORE ESCUTCHEON KIT, BN	201209BL	701.80	Matte Black	4H RT SPOUT KIT BL
200808BG	44.55	Brushed Gold	M-CORE ESCUTCHEON KIT, BG	201209BN	637.95	Brushed Nickel	4H RT SPOUT KIT BN
200808BL	49.05	Matte Black	M-CORE ESCUTCHEON KIT, BL	201211BG	136.80	Brushed Gold	SHOWER ESCUTCHEON KIT BG
200808BN	44.55	Brushed Nickel	M-CORE ESCUTCHEON KIT, BN				
200809BG	99.85	Brushed Gold	M-CORE ESCUTCHEON KIT, BG				
200809BL	109.90	Matte Black	M-CORE ESCUTCHEON KIT, BL				
200809BN	99.85	Brushed Nickel	M-CORE ESCUTCHEON KIT, BN				

GENUINE PARTS

Moen Genuine Parts

Listed in numerical order

Part Number	List	Finish	Description	Part Number	List	Finish	Description
201211BL	150.45	Matte Black	SHOWER ESCUTCHEON KIT BL	201307BL	852.90	Matte Black	FAUCET ASSEMBLYKIT - STO BL
201211BN	136.80	Brushed Nickel	SHOWER ESCUTCHEON KIT BN	201307C	553.80	Chrome	FAUCET ASSEMBLYKIT - STO CH
201212BG	78.95	Brushed Gold	POSI HANDLE KIT BG	201307SRS	775.35	Spot Resist Stainless	FAUCET ASSEMBLYKIT - STO SRS
201212BL	86.85	Matte Black	POSI HANDLE KIT BL	201308BG	630.35	Brushed Gold	FAUCET ASSEMBLYKIT - WEYMOUTH BG
201212BN	78.95	Brushed Nickel	POSI HANDLE KIT BN	201308BL	640.90	Matte Black	FAUCET ASSEMBLYKIT - WEYMOUTH BL
201213BG	138.80	Brushed Gold	THERMOSTATIC HANDLE KIT BG	201308C	450.30	Chrome	FAUCET ASSEMBLYKIT - WEYMOUTH CH
201213BL	152.75	Matte Black	THERMOSTATIC HANDLE KIT BL	201308NL	630.35	Polished Nickel	FAUCET ASSEMBLYKIT - WEYMOUTH NL
201213BN	138.80	Brushed Nickel	THERMOSTATIC HANDLE KIT BN	201308ORB	693.45	Oil Rubbed Bronze	FAUCET ASSEMBLYKIT - WEYMOUTH ORB
201214BG	137.30	Brushed Gold	VOLUME HANDLE KIT BG	201308SRS	630.35	Spot Resist Stainless	FAUCET ASSEMBLYKIT - WEYMOUTH SRS
201214BL	151.20	Matte Black	VOLUME HANDLE KIT BL	201899BL	59.60	Matte Black	ESCUTCHEON KIT BL
201214BN	137.30	Brushed Nickel	VOLUME HANDLE KIT BN	201899BN	54.20	Brushed Nickel	ESCUTCHEON KIT BN
201215BG	124.00	Brushed Gold	HANDSHOWER CRADLE KIT BG	201900BG	51.40	Brushed Gold	1H LAV HANDLE KIT BG
201215BL	136.40	Matte Black	HANDSHOWER CRADLE KIT BL	201900BL	56.55	Matte Black	1H LAV HANDLE KIT BL
201215BN	124.00	Brushed Nickel	HANDSHOWER CRADLE KIT BN	201900BN	51.40	Brushed Nickel	1H LAV HANDLE KIT BN
201216BG	117.20	Brushed Gold	TUBFILLER HANDLE KIT BG	201901BG	203.80	Brushed Gold	2HWS SPOUT KIT BG
201216BL	128.90	Matte Black	TUBFILLER HANDLE KIT BL	201901BL	224.25	Matte Black	2HWS SPOUT KIT BL
201216BN	117.20	Brushed Nickel	TUBFILLER HANDLE KIT BN	201901BN	203.80	Brushed Nickel	2HWS SPOUT KIT BN
201217BG	62.00	Brushed Gold	DIVERTER KNOBKIT, BG	201902BG	69.00	Brushed Gold	2HWS HANDLE KIT BG
201217BL	68.15	Matte Black	DIVERTER KNOBKIT, BL	201902BL	75.95	Matte Black	2HWS HANDLE KIT BL
201217BN	62.00	Brushed Nickel	DIVERTER KNOBKIT, BN	201902BN	69.00	Brushed Nickel	2HWS HANDLE KIT BN
201218BG	231.20	Brushed Gold	DIVERTER KIT, BG	201903BG	314.55	Brushed Gold	3HRT SPOUT KIT BG
201218BL	254.35	Matte Black	DIVERTER KIT, BL	201903BL	346.00	Matte Black	3HRT SPOUT KIT BL
201218BN	231.20	Brushed Nickel	DIVERTER KIT, BN	201903BN	314.55	Brushed Nickel	3HRT SPOUT KIT BN
201300BG	586.15	Brushed Gold	FAUCET ASSEMBLYKIT - ALIGN BG	201905BG	97.45	Brushed Gold	TF HANDLE KIT BG
201300BL	644.75	Matte Black	FAUCET ASSEMBLYKIT - ALIGN BL	201905BL	107.15	Matte Black	TF HANDLE KIT BL
201300BLS	644.75	Black Stainless	FAUCET ASSEMBLYKIT - ALIGN BLS	201905BN	97.45	Brushed Nickel	TF HANDLE KIT BN
201300C	418.70	Chrome	FAUCET ASSEMBLYKIT - ALIGN CH	201906BG	69.00	Brushed Gold	TF HAND SHOWER CRADLE KIT BG
201300SRS	586.15	Spot Resist Stainless	FAUCET ASSEMBLYKIT - ALIGN SRS	201906BL	75.95	Matte Black	TF HAND SHOWER CRADLE KIT BL
201301BL	605.55	Matte Black	FAUCET ASSEMBLYKIT - ARBOR BL	201906BN	69.00	Brushed Nickel	TF HAND SHOWER CRADLE KIT BN
201301C	393.25	Chrome	FAUCET ASSEMBLYKIT - ARBOR CH	201907BG	35.10	Brushed Gold	TRANSFER VALVE HANDLE KIT BG
201301ORB	770.70	Oil Rubbed Bronze	FAUCET ASSEMBLYKIT - ARBOR ORB	201907BL	38.70	Matte Black	TRANSFER VALVE HANDLE KIT BL
201301SRS	550.55	Spot Resist Stainless	FAUCET ASSEMBLYKIT - ARBOR SRS	201907BN	35.10	Brushed Nickel	TRANSFER VALVE HANDLE KIT BN
201302C	411.95	Chrome	FAUCET ASSEMBLYKIT - BRANTFORD CH	201908BG	39.45	Brushed Gold	CONTROL HANDLE KIT BG
201302ORB	634.45	Oil Rubbed Bronze	FAUCET ASSEMBLYKIT - BRANTFORD ORB	201908BL	43.35	Matte Black	CONTROL HANDLE KIT BL
201302SRS	576.75	Spot Resist Stainless	FAUCET ASSEMBLYKIT - BRANTFORD SRS	201908BN	39.45	Brushed Nickel	CONTROL HANDLE KIT BN
201304BL	1271.50	Matte Black	FAUCET ASSEMBLYKIT - NIO BL	201909BG	98.25	Brushed Gold	THERMOSTATIC HDL KIT BG
201304BLS	1398.65	Black/Stainless Steel	FAUCET ASSEMBLYKIT - NIO BLS	201909BL	108.05	Matte Black	THERMOSTATIC HDL KIT BL
201304C	825.65	Chrome	FAUCET ASSEMBLYKIT - NIO CH	201909BN	98.25	Brushed Nickel	THERMOSTATIC HDL KIT BN
201304SRS	1155.90	Spot Resist Stainless	FAUCET ASSEMBLYKIT - NIO SRS	201910BG	98.00	Brushed Gold	VOLUME HDL KIT BG
201305BL	717.55	Matte Black	FAUCET ASSEMBLYKIT - PATERSON BL	201910BL	107.80	Matte Black	VOLUME HDL KIT BL
201305C	465.95	Chrome	FAUCET ASSEMBLYKIT - PATERSON CH	201910BN	98.00	Brushed Nickel	VOLUME HDL KIT BN
201305SRS	652.35	Spot Resist Stainless	FAUCET ASSEMBLYKIT - PATERSON SRS	201911BG	161.55	Brushed Gold	TUB SPOUT KIT BG
201306BL	612.60	Matte Black	FAUCET ASSEMBLYKIT - SLEEK BL	201911BL	177.75	Matte Black	TUB SPOUT KIT BL
201306BLS	612.60	Black/Stainless Steel	FAUCET ASSEMBLYKIT - SLEEK BLS	201911BN	161.55	Brushed Nickel	TUB SPOUT KIT BN
201306C	397.80	Chrome	FAUCET ASSEMBLYKIT - SLEEK CH	201912BG	60.45	Brushed Gold	SHOWER HANDLE KIT BG
201306SRS	556.90	Spot Resist Stainless	FAUCET ASSEMBLYKIT - SLEEK SRS	201912BL	66.45	Matte Black	SHOWER HANDLE KIT BL
201307BG	775.35	Brushed Gold	FAUCET ASSEMBLYKIT - STO BG	201912BN	60.45	Brushed Nickel	SHOWER HANDLE KIT BN
				201913BG	14.95	Brushed Gold	2HWS HDL ESCT KIT BG
				201913BL	16.40	Matte Black	2HWS HDL ESCT KIT BL
				201913BN	14.95	Brushed Nickel	2HWS HDL ESCT KIT BN
				201914BG	17.05	Brushed Gold	2HWS SPOUT ESCT KIT BG
				201914BL	18.75	Matte Black	2HWS SPOUT ESCT KIT BL
				201914BN	17.05	Brushed Nickel	2HWS SPOUT ESCT KIT BN
				201915BG	17.05	Brushed Gold	3H RT HDL ESCT KIT BG
				201915BL	18.75	Matte Black	3H RT HDL ESCT KIT BL
				201915BN	17.05	Brushed Nickel	3H RT HDL ESCT KIT BN
				201916BG	21.95	Brushed Gold	3HRT SPOUT ESCT KIT BG
				201916BL	24.20	Matte Black	3HRT SPOUT ESCT KIT BL
				201916BN	21.95	Brushed Nickel	3HRT SPOUT ESCT KIT BN
				201992BL	498.45	Matte Black	SPOUT KIT

Moen Genuine Parts

Listed in numerical order

Part Number	List	Finish	Description	Part Number	List	Finish	Description
201992BLS	498.45	Black/Stainless Steel	SPOUT KIT	206297ORB	53.35	Oil Rubbed Bronze	HANDLE, ORB
201992SRS	453.00	Spot Resist Stainless	SPOUT KIT	206298BC	44.60	Brushed Chrome	ESCUTCHEON, BC
201994BG	83.05	Matte Black	WAND KIT	206301BN	56.70	Brushed Nickel	ESCUTCHEON, BN
201994BL	46.70	Matte Black	WAND KIT	206301ORB	62.35	Oil Rubbed Bronze	ESCUTCHEON, ORB
201994BLS	58.25	Black/Stainless Steel	WAND KIT	206302BN	33.30	Brushed Nickel	HANDLE, BN
201994SRS	52.40	Spot Resist Stainless	WAND KIT	206302ORB	36.65	Oil Rubbed Bronze	HANDLE, ORB
204687BL	35.00	Matte Black	HANDLE KIT BL	206303BG	75.55	Brushed Gold	ESCUTCHEON, BG
204687NL	34.45	Brushed Nickel	HANDLE KIT NL	206303BL	83.10	Matte Black	ESCUTCHEON, BL
204687SRS	33.45	Spot Resist Stainless	HANDLE KIT SRS	206303BN	75.55	Brushed Nickel	ESCUTCHEON, BN
204688BL	33.40	Matte Black	HANDLE HUB	206304BL	83.10	Matte Black	ESCUTCHEON, BL
204688NL	32.55	Polished Nickel	HANDLE HUB	206305BL	42.05	Matte Black	HANDLE, BL
204688SRS	32.05	Spot Resist Stainless	HANDLE HUB	206305BN	38.20	Brushed Nickel	HANDLE, BN
204772BL	211.85	Matte Black	SPOUT, PULLDOWN	206305ORB	42.05	Oil Rubbed Bronze	HANDLE, ORB
204772NL	216.70	Brushed Nickel	SPOUT, PULLDOWN	206306BL	91.10	Matte Black	ESCUTCHEON, BL
204772SRS	191.35	Spot Resist Stainless	SPOUT, PULLDOWN	206306BN	82.85	Brushed Nickel	ESCUTCHEON, BN
204773BL	231.90	Matte Black	SPOUT, BAR	206307BN	69.15	Brushed Nickel	ESCUTCHEON, BN
204773NL	229.75	Brushed Nickel	SPOUT, BAR	206307ORB	76.05	Oil Rubbed Bronze	ESCUTCHEON, ORB
204773SRS	221.20	Spot Resist Stainless	SPOUT, BAR	206308BN	40.45	Brushed Nickel	HANDLE, BN
204774BL	842.50	Matte Black	U BY MOEN SPOUT	206308ORB	44.50	Oil Rubbed Bronze	HANDLE, ORB
204774NL	882.25	Brushed Nickel	U BY MOEN SPOUT	206309BG	93.75	Brushed Gold	ESCUTCHEON, BG
204774SRS	821.40	Spot Resist Stainless	U BY MOEN SPOUT	206309BN	93.75	Brushed Nickel	ESCUTCHEON, BN
204775BL	106.60	Matte Black	POWERBOOST WAND KIT	206309NL	93.75	Polished Nickel	ESCUTCHEON, NL
204775NL	106.60	Brushed Nickel	POWERBOOST WAND KIT	206320BL	64.90	Matte Black	ESCUTCHEON, BL
204775SRS	110.20	Spot Resist Stainless	POWERBOOST WAND KIT	206320BN	59.00	Brushed Nickel	ESCUTCHEON, BN
204776BL	113.25	Matte Black	WAND KIT	206321BL	38.65	Matte Black	HANDLE, BL
204776NL	113.25	Brushed Nickel	WAND KIT	206321BN	35.10	Brushed Nickel	HANDLE, BN
204776SRS	107.75	Spot Resist Stainless	WAND KIT	206322BL	79.85	Matte Black	ESCUTCHEON, BL
204777BL	104.90	Matte Black	WAND KIT, BAR	206322BN	72.60	Brushed Nickel	ESCUTCHEON, BN
204777NL	94.00	Brushed Nickel	WAND KIT, BAR	206323BL	43.25	Matte Black	HANDLE, BL
204777SRS	88.15	Spot Resist Stainless	WAND KIT, BAR	206323BN	39.35	Brushed Nickel	HANDLE, BN
204778BL	37.75	Matte Black	HANDLE KIT, SIP	206324BL	96.60	Matte Black	ESCUTCHEON, BL
204778NL	38.70	Brushed Nickel	HANDLE KIT, SIP	206324BN	87.85	Brushed Nickel	ESCUTCHEON, BN
204778SRS	34.70	Spot Resist Stainless	HANDLE KIT, SIP	206328BG	93.75	Brushed Gold	ESCUTCHEON, BG
205845SRS	45.75	Spot Resist Stainless	HANDLE KIT SRS	206328BN	93.75	Brushed Nickel	ESCUTCHEON, BN
205846SRS	13.95	Spot Resist Stainless	WAND KIT SRS	206328NL	93.75	Polished Nickel	ESCUTCHEON, NL
205847SRS	61.15	Spot Resist Stainless	POWER BOOST WAND KIT SRS	206328ORB	102.70	Oil Rubbed Bronze	ESCUTCHEON, ORB
205848BL	543.00	Matte Black	FAUCET ASSEMBLY KIT BL	206329BG	39.35	Brushed Gold	HANDLE, BG
205848ORB	572.25	Oil Rubbed Bronze	FAUCET ASSEMBLY KIT ORB	206329BN	39.35	Brushed Nickel	HANDLE, BN
205848SRS	534.10	Spot Resist Stainless	FAUCET ASSEMBLY KIT SRS	206329NL	39.35	Polished Nickel	HANDLE, NL
205849BL	774.35	Black	SPOUT KIT BL	206329ORB	43.25	Oil Rubbed Bronze	HANDLE, ORB
205849C	668.70	Chrome	SPOUT KIT CHR	206330BN	93.75	Brushed Nickel	ESCUTCHEON, BN
205849ORB	811.70	Oil Rubbed Bronze	SPOUT KIT ORB	206330NL	93.75	Polished Nickel	ESCUTCHEON, NL
205849SRS	730.40	Spot Resist Stainless	SPOUT KIT SRS	206330ORB	102.70	Oil Rubbed Bronze	ESCUTCHEON, ORB
205850SRS	63.85	Spot Resist Stainless	HANDLE KIT SRS	210492BG	61.80	Brushed Gold	WMTF EXT KIT, ROUND MODERN, BG
206288BG	35.85	Brushed Gold	FINISHED H/C INDICATORS, BG	210492BL	71.30	Matte Black	WMTF EXT KIT, ROUND MODERN, BL
206288BL	39.45	Matte Black	FINISHED H/C INDICATORS, BL	210492BN	49.50	Brushed Nickel	WMTF EXT KIT, ROUND MODERN, BN
206288BN	35.85	Brushed Nickel	FINISHED H/C INDICATORS, BN	210492NL	49.50	Polished Nickel	WMTF EXT KIT, ROUND MODERN, NL
206288NL	35.85	Polished Nickel	FINISHED H/C INDICATORS, NL	210573BN	85.40	Brushed Nickel	WMTF EXT KIT, SQ, BN
206288ORB	39.45	Oil Rubbed Bronze	FINISHED H/C INDICATORS, ORB	210574BG	85.00	Brushed Gold	WMTF EXT KIT, SOFT SQ, BG
206289BG	101.15	Brushed Gold	ESCUTCHEON, BG	210574BN	85.00	Brushed Nickel	WMTF EXT KIT, SOFT SQ, BN
206289BL	111.30	Matte Black	ESCUTCHEON, BL	210574NL	85.00	Polished Nickel	WMTF EXT KIT, SOFT SQ, NL
206289BN	101.15	Brushed Nickel	ESCUTCHEON, BN	210574ORB	93.50	Oil Rubbed Bronze	WMTF EXT KIT, SOFT SQ, ORB
206289NL	101.15	Brushed Nickel	ESCUTCHEON, NL	210575BN	46.20	Brushed Nickel	90 DEG WMTF ESCUTCHEON KIT, BN
206289ORB	111.30	Oil Rubbed Bronze	ESCUTCHEON, ORB	210576BG	44.90	Brushed Gold	ALIGN WMTF ESCUTCHEON KIT, BG
206291BL	118.10	Matte Black	ESCUTCHEON, BL	210576BL	49.40	Matte Black	ALIGN WMTF ESCUTCHEON KIT, BL
206291BN	107.35	Brushed Nickel	ESCUTCHEON, BN	210576BN	44.90	Brushed Nickel	ALIGN WMTF ESCUTCHEON KIT, BN
206292BL	49.05	Matte Black	HANDLE, BL	210577BL	48.60	Matte Black	TRADITIONAL WMTF ESCUTCHEON KIT, BL
206292BN	44.60	Brushed Nickel	HANDLE, BN	210577BN	44.20	Brushed Nickel	TRADITIONAL WMTF ESCUTCHEON KIT, BN
206293BN	60.90	Brushed Nickel	ESCUTCHEON, BN	210577NL	44.20	Polished Nickel	TRADITIONAL WMTF ESCUTCHEON KIT, NL
206294BN	33.05	Brushed Nickel	HANDLE, BN	210577ORB	48.60	Oil Rubbed Bronze	TRADITIONAL WMTF ESCUTCHEON KIT, ORB
206295BG	68.30	Brushed Gold	ESCUTCHEON, BG	210578BG	44.70	Brushed Gold	CIA WMTF ESCUTCHEON KIT, BG
206295BL	75.10	Matte Black	ESCUTCHEON, BL				
206295BN	70.25	Brushed Nickel	ESCUTCHEON, BN				
206296BN	67.55	Brushed Nickel	ESCUTCHEON, BN				
206296NL	67.55	Polished Nickel	ESCUTCHEON, NL				
206296ORB	74.45	Oil Rubbed Bronze	ESCUTCHEON, ORB				
206297BN	48.50	Brushed Nickel	HANDLE, BN				
206297NL	48.50	Polished Nickel	HANDLE, NL				

Moen Genuine Parts

Listed in numerical order

Part Number	List	Finish	Description
210578BL	49.20	Matte Black	CIAWMTF ESCUTCHEON KIT, BL
210578BN	44.70	Brushed Nickel	CIAWMTF ESCUTCHEON KIT, BN
210579BG	86.70	Brushed Gold	COLINET WMTF ESCUTCHEON KIT, BG
210579BL	95.40	Matte Black	COLINET WMTF ESCUTCHEON KIT, BL
210579BN	86.70	Brushed Nickel	COLINET WMTF ESCUTCHEON KIT, BN
210580BL	53.50	Matte Black	DOUX WMTF ESCUTCHEON KIT, BL
210580BN	48.60	Brushed Nickel	DOUX WMTF ESCUTCHEON KIT, BN
210581BG	84.80	Brushed Gold	FLARAWMTF ESCUTCHEON KIT, BG
210581BN	84.80	Brushed Nickel	FLARAWMTF ESCUTCHEON KIT, BN
210581NL	84.80	Polished Nickel	FLARAWMTF ESCUTCHEON KIT, NL
210582BL	51.60	Matte Black	GENTAWMTF ESCUTCHEON KIT, BL
210582BN	46.90	Brushed Nickel	GENTAWMTF ESCUTCHEON KIT, BN
210583BL	44.00	Matte Black	GIBSON WMTF ESCUTCHEON KIT, BL
210583BN	40.00	Brushed Nickel	GIBSON WMTF ESCUTCHEON KIT, BN
210584BL	50.90	Matte Black	GLYDE WMTF ESCUTCHEON KIT, BL
210584BN	46.30	Brushed Nickel	GLYDE WMTF ESCUTCHEON KIT, BN
210585BG	49.10	Brushed Gold	VOSS WMTF ESCUTCHEON KIT, BG
210585BN	49.10	Brushed Nickel	VOSS WMTF ESCUTCHEON KIT, BN
210585NL	49.10	Polished Nickel	VOSS WMTF ESCUTCHEON KIT, NL
210585ORB	54.00	Oil Rubbed Bronze	VOSS WMTF ESCUTCHEON KIT, ORB
210843BL	60.05	Matte Black	M-CORE HANDLE KIT, BL
210843BN	66.05	Brushed Nickel	M-CORE HANDLE KIT, BN
2186BN	24.30	Brushed Nickel	STRM-FASSYMTCL MALE BN
2186P	18.25	Polished Brass	STRM-FASSYMTCL MALE PB (1)
2197BN	374.25	Brushed Nickel	ROMAN TUB SPOUT
2198SL	25.75	Stainless	1SCT MTCL BDT/LAV/KD/TS 2H&WS HDL CG
221641BG	116.15	Chrome	LEVER HANDLE KIT BG
221641BL	132.25	Matte Black	LEVER HANDLE KIT, BL
221641BN	120.20	Brushed Nickel	WEYMOUTH LVR HDL KIT BN
221641NL	132.25	Polished Nickel	LVR HDL KIT NL
221641ORB	132.25	Oil Rubbed Bronze	WEYMOUTH LVR HDL KIT ORB
221642BG	124.75	Chrome	CROSS HANDLE KIT BG
221642BL	137.25	Matte Black	CROSS HANDLE KIT, BL
221642BN	124.75	Brushed Nickel	WEYMOUTH CROSS HDL KIT BN
221642NL	132.50	Polished Nickel	CROSS HDL KIT NL
221642ORB	132.50	Oil Rubbed Bronze	WEYMOUTH CROSS HDL KIT ORB
221772BG	24.25	Chrome	FINISHED DIVERTER HANDLE CAP KIT BG
221772NL	24.25	Chrome	FINISHED DIVERTER HANDLE CAP KIT NL
252001BN	48.30	Brushed Nickel	HANDLE KIT, BN
252002BN	49.25	Brushed Nickel	HANDSHOWER CRADLE KIT, BN
252006BN	63.35	Brushed Nickel	CARTRIDGE SLEEVE, BN
252010BN	180.40	Brushed Nickel	DIVERTER KIT BN
259416BN	191.35	Brushed Nickel	RISER ELBOW KIT, BN
259416ORB	199.80	Oil Rubbed Bronze	RISER ELBOW KIT ORB
259423BN	351.60	Brushed Nickel	RISER KIT, BN
259423ORB	354.75	Oil Rubbed Bronze	RISER KIT ORB
262000BN	153.75	Brushed Nickel	HANDLE KIT CROSS, BN
262000ORB	173.25	Oil Rubbed Bronze	HANDLE KIT CROSS ORB
262001BN	60.55	Brushed Nickel	HANDLE KIT LEVER, BN
262001ORB	66.50	Oil Rubbed Bronze	HANDLE KIT LEVER ORB
262002BN	72.60	Brushed Nickel	HANDLE HUB, BN

Part Number	List	Finish	Description
262004BN	75.95	Brushed Nickel	WALL ESCUTCHEON, BN
262004ORB	83.55	Oil Rubbed Bronze	WALL ESCUTCHEON ORB
262005BN	402.50	Brushed Nickel	HANDSHOWER CRADLE, BN
262005ORB	423.00	Oil Rubbed Bronze	HANDSHOWER CRADLE ORB
262006BN	49.60	Brushed Nickel	ESCUTCHEON FLOOR, BN
262006ORB	35.40	Oil Rubbed Bronze	ESCUTCHEON FLOOR ORB
344112BL	98.25	Black	HEAD AND SPT SERVICE KIT (3942BL) BL
344112SRS	93.00	Spot Resist Stainless	HEAD AND SPOUT KIT SRS
344114ORB	112.40	Oil Rubbed Bronze	HEAD AND SPT SERVICE KIT (3944ORB) ORB
344114SRS	110.40	Spot Resist Stainless	HEAD AND SPOUT KIT SRS
3919BN	24.25	Brushed Nickel	FRA MALE THRD 2.2 GPM BN CRD
3919CSL	24.25	Classic Stainless	FRA MALE THRD 2.2 GPM CSL CRD
3919ORB	26.75	Oil Rubbed Bronze	FRA MALE THRD 2.2 GPM ORB
3919WR	26.75	Wrought Iron	FRA MALE THRD 2.2 GPM WR CRD
90478BN	40.60	Brushed Nickel	TW MTG SCREW FACE PLATE 2 BN
90478NL	15.95	Polished Nickel	TW MTG SCREW FACE PLATE 2 NL
90478ORB	44.70	Oil Rubbed Bronze	TW MTG SCREW FACE PLATE 2 ORB
920-002	7.95	N/A or Unfinished	FLO BY MOEN AC POWER ADAPTER
920-007	283.00	N/A or Unfinished	Flo Smart Monitor/Shutoff Cell Antenna
930-011	7.65	N/A or Unfinished	FLO BY MOEN AC ADAPTER WALL MOUNT
935-001	22.35	N/A or Unfinished	FLO BY MOEN 0.75" TAILPIECES, NPT
935-002	7.95	N/A or Unfinished	FLO BY MOEN 0.75" TAILPIECES, CC/SOLDER
935-003	1.90	N/A or Unfinished	FLO BY MOEN 0.75" & 1.00" ORING KIT
935-004	54.70	N/A or Unfinished	FLO BY MOEN 1.00" TAILPIECES, NPT
935-005	14.70	N/A or Unfinished	FLO BY MOEN 1.00" TAILPIECES, CC/SOLDER
935-006	22.85	N/A or Unfinished	FLO BY MOEN 1.25" TAILPIECES, NPT
935-007	15.15	N/A or Unfinished	FLO BY MOEN 1.25" TAILPIECES, CC/SOLDER
935-009	8.40	N/A or Unfinished	FLO BY MOEN 0.75" PLASTIC UNION NUTS
935-011	73.80	N/A or Unfinished	FLO BY MOEN 1.25" BRASS UNION NUTS
935-014	20.85	N/A or Unfinished	SWS PLASTIC WATERWAY COVER .75" & 1"
935-015	26.45	N/A or Unfinished	SWS PLASTIC WATERWAY COVER 1.25"
935-016	9.05	N/A or Unfinished	FLO FLOW METER, 0.75" & 1.00"
935-017	10.95	N/A or Unfinished	FLO FLOW METER, 1.25"
93990W	18.30	Glacier	HDL DOME SM KD 1H GLC
940-001	12.70	N/A or Unfinished	Property Water Security WiFi Service-Mo
940-002	50.85	N/A or Unfinished	Property Water Security WiFi Service-Qu
940-003	152.55	N/A or Unfinished	Property Water Security WiFi Service-Ann
940-004	12.70	N/A or Unfinished	Property Water Security Cell Service-Qu
940-005	50.85	N/A or Unfinished	FBM SUBSCRIPTION CELLULAR QUARTERLY
940-006	152.55	N/A or Unfinished	Property Water Security Cell Service-Ann
95626BN	62.45	Brushed Nickel	ONE PC HDL HUB MTCL POSI KIT BN
95626ORB	66.25	Oil Rubbed Bronze	ONE PC HDL HUB MTCL POSI KIT ORB
96885CBN	65.65	Classic Brushed Nickel	ESCT CHT/TC TS 1H POSI CBN
97372BN	101.30	Brushed Nickel	HANDLE INSERT
97462BN	69.05	Brushed Nickel	HDL MTCL LNR NSRT LRG CHR BN 1
97476SL	20.75	Stainless	FRA MALE THD MTCL 2.0 GPM SL

Moen Genuine Parts

Listed in numerical order

Part Number	List	Finish	Description
97491BN	89.55	Brushed Nickel	SCT,MTCL POSI-TEMP 1H T/SBN
97491ORB	98.45	Oil Rubbed Bronze	ESCT MTCL 1H POSI T/S ORB
97491WR	98.45	Wrought Iron	ESCT, MTCL POSI-TEMP 1H T/SWR
97577BN	89.55	Brushed Nickel	ESCT MTCL 1H T/S BN
97577ORB	98.45	Oil Rubbed Bronze	ESCT MTCL 1H T/S ORB
BH5294BN	129.30	Brushed Nickel	COORDINATING HOTEL SHELF BN
CA3919	16.75	Chrome	FRA MALE THRD 1.5 GPM CHR CRD
CA3924	16.75	Chrome	FRA FEMALE THRD 1.5 GPM CHR CRD
CL145058	21.05	N/A or Unfinished	MOENTROL TRIM ADAPTER FOR STANDARD VLV
SK10065	0.60	N/A or Unfinished	TOOL, HEX WRENCH .109 HEX
SK103205	2.55	N/A or Unfinished	WSHR, WAVE .9700D .870ID .115FHSS
SK107267	1.40	N/A or Unfinished	ADPT, HNDL VIL 2H/MWS LAV COLD
SK107268	1.40	N/A or Unfinished	ADPT, HNDL VIL 2H/MWS LAV/HOT
SK107656	0.70	N/A or Unfinished	SCRW, 6-32 UNC .61 CAP HD HEX COATED SS
SK113537	0.80	N/A or Unfinished	SCRW, 10-24 UNC .51 TRS HD PATCH SS
SK114318	2.95	N/A or Unfinished	PIVOT RTNR
SK12382	12.75	N/A or Unfinished	STOP TUBE SHWR 1H EXT 1" STNL STL BLNK
SK123852	5.45	N/A or Unfinished	SCRW, 8-32 UNC 2.81 TRS HD BRS CHR
SK126316	6.35	N/A or Unfinished	ADPT, HNDL 1H KD LVR
SK126717	10.95	N/A or Unfinished	ADPT, HNDL EXT 1H T/S KNOB BRS
SK137304	2.25	N/A or Unfinished	CARTRIDGE NUT 1H PLASTIC
SK1423	88.40	N/A or Unfinished	BALSPL MNT TS, BULK (120 QTY)
SK142368	0.55	N/A or Unfinished	SET SCREW 10-32, W/ THREAD PATCH
SK142555	2.75	N/A or Unfinished	MOUNTING NUT, PLSTC, 1H KD
SK144211	12.15	N/A or Unfinished	MOUNTING FLANGE
SK150532	1.50	N/A or Unfinished	SCRW, 10-24 UNC 1.47 PAN HD PATCH SS
SK150534	3.70	N/A or Unfinished	SCRW, 10-24 UNC 2.14 TRS HD PATCH SS
SK152780	20.85	N/A or Unfinished	DURALAST 1255 HIGH FLOW CARTRIDGE
SK156633	25.50	Chrome	ESCUT, T/S 1H POSI CHR MRKD
SK1606	0.90	N/A or Unfinished	SCRW, 8-32 S-T .36 PAN HD SS WAXED
SK1711	4.20	N/A or Unfinished	RTNR CLP LRV & #4901 BULK
SK92143	1.00	Chrome	SCRW, 10-16 S-T .61 OVL HD STL CHR
SK93609	2.30	N/A or Unfinished	PIVOT STOP CHT/MN/MTCL
SK93636	1.65	N/A or Unfinished	CONN, HNDL KD 1H LVR
SK93646	2.30	N/A or Unfinished	PIVOT STOP BEST
SK95502	2.90	N/A or Unfinished	NUT, CART MWS MTCL LAV PLSTC
SK95593	0.90	N/A or Unfinished	TOOL, HEX WRENCH .094 HEX
SK95733	1.55	N/A or Unfinished	WSHR, BRNG 1.1820D 1.088ID W/SHLDR PLSTC
SK97302	1.90	N/A or Unfinished	RTNR, CART 2HT/S
SK97307	2.50	N/A or Unfinished	SLEEVE, BEARING 1.030ID 2.55WIDE SHLDR
SK97311	2.95	N/A or Unfinished	WSHR, WAVE .9950D .895ID .154FHSS
SK97353	1.40	N/A or Unfinished	ADPT, HNDL MTCL 2H HOT SIDE
SK97354	1.40	N/A or Unfinished	ADPT, HNDL MTCL 2H COLD SIDE
SK97876	4.40	N/A or Unfinished	STEM EXTENSION, COLD
SK97877	4.40	N/A or Unfinished	STEM EXTENSION, HOT
SK98285	0.80	N/A or Unfinished	SCRW, 8-32 UNC .36 PAN HD SS
SK99195	0.80	N/A or Unfinished	SCRW, 8-32 UNC 1.22 RND HD STL ZINC

Part Number	List	Finish	Description
SR2200BN	18.45	Brushed Nickel	DOUBLE SHOWER CURTAIN RINGS (12) BN BBB
SR22000WB	18.75	Old World Bronze	DOUBLE SHOWER CURTAIN RINGS (12) OWB BBB
T2721BL	173.75	Matte Black	2F/3F GLYDE TRANSFER VALVE BL
Y2622BN	56.80	Brushed Nickel	BANBURY 24 DOUBLE TOWEL BAR BN

GENUINE PARTS

Bulk



Glyde™ Two-Handle Centerset Bathroom Faucet / 66172

Please see [moen.com/customer-support/warranty](https://www.moen.com/customer-support/warranty) for complete product warranty information.

Table of Contents

- 592 Kitchen
- 593 Sinks
- 594 Bathroom
- 598 M-CORE® Showering
- 600 Posi-Temp® Showering Rough-in Valves and Trim
- 608 Non-Pressure Balancing Showering

MOEN® BULK-PACK

Bulk-Pack gives you everything you need for on-site installation: kitchen, lavatory, roman tub, tub/shower faucets and stainless steel sinks in case lots.

Each kitchen and lavatory faucet carton contains individually packaged faucets ready for installation.



Roman tub and tub/shower faucets come packaged in two cartons. The rough-in valves are in one carton, the finish trim in another carton. This helps you avoid losing or damaging the trim.

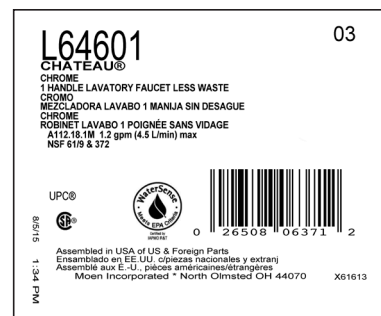

Each carton is labeled for easy identification.







CROSS-REFERENCE For Bulk Faucets and Valves

CROSS-REFERENCE TABLE

	Single Pack	Bulk Pack
Kitchen	7425	67425
Kitchen	7430	67430
Kitchen	7840	67840
Kitchen	67315C	67315C
Kitchen	67315SRS	67315SRS
Kitchen	7545C	67545C
Sink	GS181210B	BGS181210B
Valves	2510	62300
Valves	2520	62320
Valves	2570	62370
Valves	2580	62380
Valves	2590	62390
Valves	3570	63170
Valves	9000	69000
Tub/Shower	T2132	T62132
Tub/Shower	T2133	T62133
Tub/Shower	T2151	T62151
Tub/Shower	T2152	T62152
Tub/Shower	T2153	T62153
Tub/Shower	T2182	T62182
Tub/Shower	T2183	T62183
Tub/Shower	T2742	T62742
Tub/Shower	T2743	T62743
Tub/Shower	2352	T182 + 62320
Tub/Shower	L2352	TL182 + 62300
Tub/Shower	2353	T183 + 62320
Tub/Shower	L2353	TL183 + 62300
Tub/Shower	L2361	TL181 + 62370
Tub/Shower	L2362	TL182 + 62370
Tub/Shower	2363	T183 + 62370
Tub/Shower	L2363	TL183 + 62370
Bathroom Sink Faucet	L4601	L64601
Bathroom Sink Faucet	L4621	L64620
Bathroom Sink Faucet	L4625	L64625
Bathroom Sink Faucet	4925	64925
Bathroom Sink Faucet	6172	66172
Bathroom Sink Faucet	6410	66410
Bathroom Sink Faucet	6610	66610
Bathroom Sink Faucet	6802	66802

BULK Kitchen Faucets

Must order in Case Quantity.







		MODEL	LIST	FINISH	CASE QTY
CAMERIST® ONE-HANDLE PULLOUT KITCHEN FAUCET					
	<ul style="list-style-type: none"> • application: one or three hole • spout height: 12.00" • connection size: 3/8" • connection type: compression • number of functions: two-function • spray type: aerated stream; powerful cleaning rinse • hose length: 68" • deckplate: included 	1.5 GPM (5.7 L/min) max.			
		67545C	410.25	Chrome	3
 POWERCLEAN reflex DURALOCK® DURALAST®					
INTEGRA® ONE-HANDLE PULLOUT KITCHEN FAUCET					
	<ul style="list-style-type: none"> • application: one or three hole • overall height: 10.63" • connection size: 3/8" • connection type: compression • number of functions: two-function • spray type: aerated stream; powerful cleaning rinse • hose length: 59" • deckplate: included 	1.5 GPM (5.7 L/min) max.			
		67315C	313.00	Chrome	6
		67315SRS●	391.30	Spot Resist Stainless	6
 POWERCLEAN DURALOCK® DURALAST®					
CAMERIST® ONE-HANDLE KITCHEN FAUCET					
	<ul style="list-style-type: none"> • application: two to four hole • overall height: 8.13" • connection size: 3/8" • connection type: compression • spray type: aerated stream • deckplate: included • side spray: included 	1.5 GPM (5.7 L/min) max.			
		67840	258.00	Chrome	6
 DURALOCK® DURALAST®					

BULK

- Spot Resist™ Stainless Finish
- POWERCLEAN** Power Clean™ Technology
- reflex Self-Retracting Spray Hose
- DURALOCK** Duralock® Quick Connections
- DURALAST** Duralast® Cartridge

BULK Kitchen Faucets

Must order in Case Quantity.



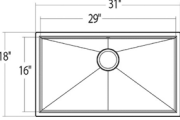











		MODEL	LIST	FINISH	CASE QTY
CHATEAU®	ONE-HANDLE KITCHEN FAUCET				
	<ul style="list-style-type: none"> • application: three hole • overall height: 8.50" • connection size: 3/8" • connection type: compression. 	1.5 GPM (5.7 L/min) max.			
	<ul style="list-style-type: none"> •  DURALAST® 	67425	170.20	Chrome	6
	<ul style="list-style-type: none"> • application: four hole • overall height: 8.50" • connection size: 3/8" • connection type: compression • side spray: included 	1.5 GPM (5.7 L/min) max.			
	<ul style="list-style-type: none"> •  DURALOCK® DURALAST® 	67430	213.95	Chrome	6
	<ul style="list-style-type: none"> • application: three hole • overall height: 8.50" • connection size: 3/8" • connection type: compression • side spray: included 	1.5 GPM (5.7 L/min) max.			
	<ul style="list-style-type: none"> •  DURALOCK® DURALAST® 	67434	213.95	Chrome	6

1800 SERIES	SINGLE BOWL UNDERMOUNT SINK				
ADA/FHA COMPLIANT	<ul style="list-style-type: none"> • minimum cabinet size: 36" • depth size: 6" • drain location: rear center • drain opening size: 3-5/8" • ADA/FHA compliant: yes • weight: 27 lbs. 	BGS181210B	462.95	Satin Stainless	36
					

BULK

BULK Bathroom Faucets





Must order in Case Quantity.

		MODEL	LIST	FINISH	CASE QTY
CHATEAU®	ONE-HANDLE BATHROOM FAUCET				
	<ul style="list-style-type: none"> • application: three hole • center dimensions: 4" center • connection size: 1/2" • connection type: IPS • drain assembly: drain not included <p> DURALAST®</p>	 1.2 GPM (4.5L/min) max. 64601	151.80	Chrome	12
	<ul style="list-style-type: none"> • application: three hole • center dimensions: 4" center • connection size: 1/2" • connection type: IPS • drain assembly: 50% plastic/ 50% metal • drain assembly type: lift rod <p> DURALAST®</p>	 1.2 GPM (4.5L/min) max. 64621	186.55	Chrome	12
	<ul style="list-style-type: none"> • application: three hole • center dimensions: 4" center • supply line length: flexible • connection size: 3/8" • connection type: compression • drain assembly: drain not included <p>  DURALAST®</p>	 1.2 GPM (4.5L/min) max. L64600	151.80	Chrome	12
	<ul style="list-style-type: none"> • application: three hole • center dimensions: 4" center • connection size: 1/2" • connection type: IPS • drain assembly: drain not included <p>  DURALAST®</p>	 1.2 GPM (4.5L/min) max. L64601	151.80	Chrome	12

BULK

BULK Bathroom Faucets













Must order in Case Quantity.

	MODEL	LIST	FINISH	CASE QTY
CHATEAU® ONE-HANDLE BATHROOM FAUCET (CONTINUED)				
	<ul style="list-style-type: none"> • application: three hole • center dimensions: 4" center • connection size: 1/2" • connection type: IPS • drain assembly: metal • drain assembly type: lift rod 	<p>1.2 GPM (4.5L/min) max.</p> <p>L64620</p>	198.00 Chrome	12
	<p>🔥 ♿ DURALAST®</p>			
	<ul style="list-style-type: none"> • application: three hole • center dimensions: 4" center • connection size: 1/2" • connection type: IPS • drain assembly: 50% plastic/ 50% metal • drain assembly type: lift rod 	<p>1.2 GPM (4.5L/min) max.</p> <p>L64621</p>	186.55 Chrome	12
	<p>🔥 ♿ DURALAST®</p>			
	<ul style="list-style-type: none"> • application: three hole • center dimensions: 4" center • supply line length: flexible • connection size: 3/8" • connection type: compression • drain assembly: metal • drain assembly type: lift rod 	<p>1.2 GPM (4.5L/min) max.</p> <p>L64624</p>	203.70 Chrome	12
	<p>🔥 ♿ DURALAST®</p>			
	<ul style="list-style-type: none"> • application: three hole • center dimensions: 4" center • supply line length: flexible • connection size: 3/8" • connection type: compression • drain assembly: 50% plastic/ 50% metal • drain assembly type: lift rod 	<p>1.2 GPM (4.5L/min) max.</p> <p>L64625</p>	188.45 Chrome	12
	<p>🔥 ♿ DURALAST®</p>			
	<ul style="list-style-type: none"> • application: three hole • center dimensions: 4" center • connection size: 1/2" • connection type: IPS • drain assembly: metal • drain assembly type: lift rod • red/blue markings: included 	<p>1.2 GPM (4.5L/min) max.</p> <p>L64635</p>	203.70 Chrome	12
	<p>🔥 ♿ DURALAST®</p>			

BULK

BULK Bathroom Faucets







Must order in Case Quantity.

		MODEL	LIST FINISH	CASE QTY
	DARTMOOR® TWO-HANDLE CENTERSET BATHROOM FAUCET			
	<ul style="list-style-type: none"> • application: three hole • center dimensions: 4" center • connection size: 1/2" • connection type: IPS • drain assembly: 50% plastic/ 50% metal • drain assembly type: lift rod <p>   DURALAST® </p>	1.2 GPM (4.5L/min) max. 66802	195.10 Chrome	6
	GLYDE™ TWO-HANDLE CENTERSET BATHROOM FAUCET			
	<ul style="list-style-type: none"> • application: three hole • center dimensions: 4" center • connection size: 1/2" • connection type: IPS • drain assembly: 50% plastic/ 50% metal • drain assembly type: lift rod <p>   DURALAST® </p>	1.2 GPM (4.5L/min) max. 66172	195.10 Chrome	6
	BRANTFORD® TWO-HANDLE CENTERSET BATHROOM FAUCET			
	<ul style="list-style-type: none"> • application: three hole • center dimensions: 4" center • connection size: 1/2" • connection type: IPS • drain assembly: 50% plastic/ 50% metal • drain assembly type: lift rod <p>   DURALAST® </p>	1.2 GPM (4.5L/min) max. 66110	195.10 Chrome	6
	EVA® TWO-HANDLE CENTERSET BATHROOM FAUCET			
	<ul style="list-style-type: none"> • application: three hole • center dimensions: 4" center • connection size: 1/2" • connection type: IPS • drain assembly: 50% plastic/ 50% metal • drain assembly type: lift rod <p>   DURALAST® </p>	1.2 GPM (4.5L/min) max. 66410	195.10 Chrome	6

BULK

BULK Bathroom Faucets

Must order in Case Quantity.

		MODEL	LIST	FINISH	CASE QTY
	CHATEAU® TWO-HANDLE CENTERSET BATHROOM FAUCET				
	<ul style="list-style-type: none"> • application: three hole • center dimensions: 4" center • connection size: 1/2" • connection type: IPS • drain assembly: drain not included 	64900	1.2 GPM (4.5L/min) max. 118.65	Chrome	12
	<ul style="list-style-type: none"> • application: three hole • center dimensions: 4" center • connection size: 1/2" • connection type: IPS • drain assembly: metal • drain assembly type: lift rod 	64919	1.2 GPM (4.5L/min) max. 164.55	Chrome	12
	DURALAST®				
	<ul style="list-style-type: none"> • application: three hole • center dimensions: 4" center • connection size: 1/2" • connection type: IPS • drain assembly: 50% plastic/ 50% metal • drain assembly type: lift rod 	64920	1.2 GPM (4.5L/min) max. 164.55	Chrome	12
	DURALAST®				
	<ul style="list-style-type: none"> • application: three hole • center dimensions: 4" center • connection size: 1/2" • connection type: IPS • drain assembly: drain not included 	64922	1.2 GPM (4.5L/min) max. 118.65	Chrome	12
	DURALAST®				
	<ul style="list-style-type: none"> • application: three hole • center dimensions: 4" center • connection size: 1/2" • connection type: IPS • drain assembly: 50% plastic/ 50% metal • drain assembly type: lift rod 	64925	1.2 GPM (4.5L/min) max. 164.55	Chrome	12
	DURALAST®				
	M-PACT® WIDESPREAD VALVE				
	<ul style="list-style-type: none"> • application: three hole • center dimensions: 8" - 16" center • connection size: 1/2" • connection type: IPS • drain assembly: metal • drain assembly type: lift rod 	69000	143.90	1/2" IPS	6
DURALOCK® DURALAST®					









BULK

 WaterSense Certified
 Moen® **M•PACT®** Common Valve System
 DURALOCK® Duralock® Quick Connections
 DURALAST® Duralast® Cartridge



BULK M-CORE™ Showering

Must order in Case Quantity.

LEGEND®	M-CORE® 3-SERIES TUB/SHOWER TRIM	MODEL	LIST	FINISH	CASE QTY
	<ul style="list-style-type: none"> • showerhead: one-function • showerhead size: 2-1/2" diameter spray head • spout length: 5 1/2" • spout connection type: slip fit • tub spout type: diverter • valve sold separately • includes: pressure balanced cartridge with volume and temperature control 	Flow Rate:	2.5 gpm (9.5 L/min) max		
		UTL172	251.45	Chrome	4
		Flow Rate:	1.75 gpm (6.65 L/min) max		
		 UTL172EP	251.45	Chrome	4
<hr/>					
LEGEND®	M-CORE™ 3-SERIES SHOWER ONLY TRIM				
	<ul style="list-style-type: none"> • showerhead: one-function • showerhead size: 2-1/2" diameter spray head • valve sold separately • includes: pressure balanced cartridge with volume and temperature control 	Flow Rate:	2.5 gpm (9.5 L/min) max		
		UTL171	209.20	Chrome	4
		Flow Rate:	1.75 gpm (6.65 L/min) max		
		 UTL171EP	209.20	Chrome	4
<hr/>					
LEGEND®	M-CORE™ 3-SERIES VALVE ONLY TRIM				
	<ul style="list-style-type: none"> • valve sold separately • includes: pressure balanced cartridge with volume and temperature control 	UTL170	203.15	Chrome	4

BULK

VALVE:
PAGE 465

HOW TO ORDER

TRIM
PART NO.



+

VALVE
PART NO.



=

COMPLETE
FAUCET



BULK M-CORE™ Showering







Must order in Case Quantity.

TUB/SHOWER OR SHOWER ONLY APPLICATION				
Description	Model	List	Connection	Case Qty
Four port	U140CI	71.20	1/2" CC/IPS	6
Four port	U140X	71.20	1/2" Crimp Ring PEX with CC/IPS Tub	6
Four port	U140CX	71.20	1/2" Cold Exp. Pex with CC/IPS Tub	6
Four port	U140V	87.20	1/2" CPVC with CC/IPS Tub	6
Four port with quarter turn stops	U140CIS	102.45	1/2" CC/IPS	6
Four port with quarter turn stops	U140XS	102.45	1/2" Crimp Ring PEX with CC/IPS Tub	6
Four port with quarter turn stops	U140CXS	102.45	1/2" Cold Exp. Pex with CC/IPS Tub	6
Four port with quarter turn stops	U140VS	118.50	1/2" CPVC with CC/IPS Tub	6
Four port Pre-Fab	U140X-PF	80.40	1/2" Crimp Ring PEX	3
Four port Pre-Fab	U140CX-PF	80.40	1/2" Cold Exp. PEX	3
Four port Pre-Fab with quarter turn stops	U140XS-PF	111.70	1/2" Crimp Ring PEX	3
Four port Pre-Fab with quarter turn stops	U140CXS-PF	111.70	1/2" Cold Exp. PEX	3

SHOWER ONLY APPLICATION				
Description	Model	List	Connection	Case Qty
Three port	U130CI	71.20	1/2" CC/IPS	6
Three port	U130X	71.20	1/2" Crimp Ring PEX	6
Three port	U130CX	71.20	1/2" Cold Exp. Pex	6
Three port with quarter turn stops	U130CIS	102.45	1/2" CC/IPS	6
Three port with quarter turn stops	U130XS	102.45	1/2" Crimp Ring PEX	6
Three port with quarter turn stops	U130CXS	102.45	1/2" Cold Exp. Pex	6

BULK Posi-Temp® Showering

Must order in Case Quantity.

		MODEL	LIST	FINISH	CASE QTY
DARTMOOR®	POSI-TEMP® TUB/SHOWER TRIM				
	<ul style="list-style-type: none"> • showerhead: one-function • showerhead size: 4" diameter spray head • spout length: 7" • spout connection type: slip fit • tub spout type: diverter • valve sold separately 	Flow Rate:	2.5 gpm (9.5 L/min) max		
		T62183	116.60	Chrome	12
GLYDE™	POSI-TEMP® TUB/SHOWER TRIM				
	<ul style="list-style-type: none"> • showerhead: one-function • showerhead size: 3-3/4" diameter spray head • spout length: 7" • spout connection type: slip fit • tub spout type: diverter • valve sold separately 	Flow Rate:	2.5 gpm (9.5 L/min) max		
		T62743	116.60	Chrome	6
BRANTFORD®	POSI-TEMP® TUB/SHOWER TRIM				
	<ul style="list-style-type: none"> • showerhead: one-function • showerhead size: 3-1/2" diameter spray head • spout length: 6 1/2" • spout connection type: slip fit • tub spout type: diverter • valve sold separately 	Flow Rate:	2.5 gpm (9.5 L/min) max		
		T62153	116.60	Chrome	12
		 T62153EP	116.60	Chrome	12

VALVE:
PAGE 467

HOW TO ORDER

TRIM
PART NO.



+

VALVE
PART NO.



=

COMPLETE
FAUCET





BULK



BULK Posi-Temp® Showering

Must order in Case Quantity.

		MODEL	LIST	FINISH	CASE QTY
EVA® 	POSI-TEMP® TUB/SHOWER TRIM				
	<ul style="list-style-type: none"> • showerhead functions: one-function • showerhead size: 3-1/2" diameter spray head • spout length: 7" • spout connection type: slip fit • tub spout type: diverter • valve sold separately 	Flow Rate:	2.5 gpm (9.5 L/min) max		
		T62133	116.60	Chrome	12
		Flow Rate:	1.75 gpm (6.65 L/min) max		
		T62133EP	116.60	Chrome	12

CHATEAU® 	POSI-TEMP® TUB/SHOWER TRIM				
	<ul style="list-style-type: none"> • showerhead functions: one-function • showerhead size: 2-1/2" diameter spray head • spout length: 5 1/2" • spout connection type: slip fit • tub spout type: diverter • red/blue markings: included • valve sold separately 	Flow Rate:	2.5 gpm (9.5 L/min) max		
		T183	79.65	Chrome	12
		Flow Rate:	1.75 gpm (6.65 L/min) max		
		T183EP	79.65	Chrome	12







BULK



BULK Posi-Temp® Showering

Must order in Case Quantity.

CHATEAU®	POSI-TEMP® TUB/SHOWER TRIM	MODEL	LIST	FINISH	CASE QTY
	<ul style="list-style-type: none"> • showerhead: one-function • showerhead size: 2-1/2" diameter spray head • tub spout type: diverter • red/blue markings: included • valve: sold separately 		Flow Rate:	2.5 gpm (9.5 L/min) max	
		TL183	79.65	Chrome	12
			Flow Rate:	1.75 gpm (6.65 L/min) max	
		 TL183EP	79.65	Chrome	12
	<ul style="list-style-type: none"> • showerhead: showerhead sold separately • spout length: 5 1/2" • spout connection type: slip fit • tub spout type: diverter • red/blue markings: included • valve sold separately 	TL183NH	69.95	Chrome	12

VALVE:
PAGE 467

HOW TO ORDER

TRIM
PART NO.



+

VALVE
PART NO.



=

COMPLETE
FAUCET















BULK



BULK Posi-Temp® Showering

Must order in Case Quantity.

		MODEL	LIST	FINISH	CASE QTY
DARTMOOR®  	POSI-TEMP® SHOWER ONLY TRIM <ul style="list-style-type: none"> showerhead: one-function showerhead size: 4" diameter spray head valve sold separately  	Flow Rate:	2.5 gpm (9.5 L/min) max		
		T62182	77.40	Chrome	12
GLYDE™  	POSI-TEMP® SHOWER ONLY TRIM <ul style="list-style-type: none"> showerhead: one-function showerhead size: 3-3/4" diameter spray head valve sold separately  	Flow Rate:	2.5 gpm (9.5 L/min) max		
		T62174	77.40	Chrome	12
BRANTFORD®  	POSI-TEMP® SHOWER ONLY TRIM <ul style="list-style-type: none"> showerhead: one-function showerhead size: 3-3/8" diameter spray head valve sold separately  	Flow Rate:	2.5 gpm (9.5 L/min) max		
		T62152	77.40	Chrome	12
		 T62152EP	77.40	Chrome	12

VALVE:
PAGE 467

HOW TO ORDER

TRIM
PART NO.



+

VALVE
PART NO.



=

COMPLETE
FAUCET









BULK



BULK Posi-Temp® Showering

Must order in Case Quantity.

		MODEL	LIST FINISH	CASE QTY
EVA®  	POSI-TEMP® SHOWER ONLY TRIM <ul style="list-style-type: none"> • showerhead: one-function • showerhead size: 3-1/2" diameter spray head • valve sold separately  	Flow Rate:	2.5 gpm (9.5 L/min) max	
		T62132	77.40 Chrome	12
		Flow Rate:	1.75 gpm (6.65 L/min) max	
		T62132EP	77.40 Chrome	12
CHATEAU®  	POSI-TEMP® SHOWER ONLY TRIM <ul style="list-style-type: none"> • showerhead: one-function • showerhead size: 2-1/2" diameter spray head • red/blue markings: included • valve sold separately 	Flow Rate:	2.5 gpm (9.5 L/min) max	
		T182	49.05 Chrome	12











BULK

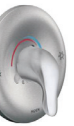

BULK Posi-Temp® Showering

Must order in Case Quantity.

		MODEL	LIST	FINISH	CASE QTY
CHATEAU®	POSI-TEMP® SHOWER ONLY TRIM				
 <ul style="list-style-type: none"> • showerhead: one-function eco performance • showerhead size: 2-1/2" diameter spray head • red/blue markings: included • valve: sold separately 		Flow Rate:	1.75 gpm (6.65 L/min) max.		
		TL182EP	49.05	Chrome	12
 <ul style="list-style-type: none"> • showerhead: one-function • showerhead size: 2-1/2" diameter spray head. • red/blue markings: included • valve: sold separately 		Flow Rate:	2.5 gpm (9.5 L/min) max		
		TL182	49.05	Chrome	12
 		Flow Rate:	1.75 gpm (6.65 L/min) max.		
		TL182EP	49.05	Chrome	12
 <ul style="list-style-type: none"> • showerhead: showerhead sold separately • red/blue markings: included • valve sold separately 		TL182NH	46.50	Chrome	12

VALVE:
PAGE 467

HOW TO ORDER

TRIM
PART NO.



+

VALVE
PART NO.



=

COMPLETE
FAUCET







BULK



BULK Posi-Temp® Showering

Must order in Case Quantity.

		MODEL	LIST	FINISH	CASE QTY
BRANTFORD®	POSI-TEMP® VALVE ONLY TRIM				
	<ul style="list-style-type: none"> valve sold separately  	T62151	57.60	Chrome	12
CHATEAU®	POSI-TEMP® VALVE ONLY TRIM				
	<ul style="list-style-type: none"> red/blue markings: included valve: sold separately  	TL181	44.55	Chrome	12
	<ul style="list-style-type: none"> red/blue markings: included valve: sold separately  	T187	44.55	Chrome	12
	<ul style="list-style-type: none"> red/blue markings: included valve: sold separately 	T181	44.55	Chrome	12

BULK



Posi-Temp® Mixing Showering Rough-In Valves



(For product details, images, and bulk pack offering please reference page 467-469 in Valve section)

TUB/SHOWER OR SHOWER ONLY APPLICATION				
Description	Model	List	Connection	Case Qty
Four port; adjustable temperature limit stops	62320	145.15	1/2" CC	12
Four port; adjustable temperature limit stops; test plug included	FP62320	145.15	1/2" CC	12
Four port; adj. temp. limit stops; quarter turn stops included	62370	176.45	1/2" CC	12
Four port; adj. temp. limit stops; quarter turn stops and test plug included	FP62370	176.45	1/2" CC	12
Four port; adjustable temperature limit stops	62300	145.15	1/2" IPS	12
Four port; adjustable temperature limit stops; test plug included	FP62300	145.15	1/2" IPS	12
Four port; adj. temp. limit stops; quarter turn stops included	62390	176.45	1/2" IPS	12
Four port; adjustable temperature limit stops	62380	145.15	1/2" Crimp Ring PEX	12
Four port; adjustable temperature limit stops; test plug included	FP62380	145.15	1/2" Crimp Ring PEX	12
Four port; adj. temp. limit stops; quarter turn stops included	62360	176.45	1/2" Crimp Ring PEX	12
Four port; adjustable temperature limit stops	62365	145.15	1/2" Cold Exp. PEX	12
Four port; adjustable temperature limit stops; test plug included	FP62365	145.15	1/2" Cold Exp. PEX	12
Four port; adj. temp. limit stops; quarter turn stops included	62385	176.45	1/2" Cold Exp. PEX	12
Four port; adj. temp. limit stops; quarter turn stops and test plug included	FP62385	176.45	1/2" Cold Exp. PEX	12
Four port; adjustable temperature limit stops	62340	161.05	1/2" CPVC	12
Four port; adjustable temperature limit stops; test plug included	FP62340	161.05	1/2" CPVC	12
Four port; adj. temp. limit stops; quarter turn stops included	62330	192.40	1/2" CPVC	12
Four port; adjustable temperature limit stops; pre-fab	62380PF	165.35	1/2" Crimp Ring PEX	12
Four port; adjustable temperature limit stops; test plug included; pre-fab	FP62380PF	165.35	1/2" Crimp Ring PEX	12
Four port; adj. temp. limit stops; quarter turn stops included; pre-fab	62360PF	196.55	1/2" Crimp Ring PEX	12
Four port; adj. temp. limit stops; quarter turn stops and test plug included; pre-fab	FP62360PF	196.55	1/2" Crimp Ring PEX	12
Four port; adjustable temperature limit stops; pre-fab	62365PF	165.35	1/2" Cold Exp. PEX	12
Four port; adjustable temperature limit stops; test plug included; pre-fab	FP62365PF	165.35	1/2" Cold Exp. PEX	12
Four port; adj. temp. limit stops; quarter turn stops included; pre-fab	62385PF	196.55	1/2" Cold Exp. PEX	12
Four port; adj. temp. limit stops; quarter turn stops and test plug included; pre-fab	FP62385PF	196.55	1/2" Cold Exp. PEX	12

SHOWER ONLY APPLICATION				
Description	Model	List	Connection	Case Qty
Three port; adjustable temperature limit stops	62345	145.15	1/2" IPS, CC	12
Three port; adjustable temperature limit stops; test plug included	FP62325PF	158.15	1/2" Crimp Ring PEX	12
Three port; adjustable temperature limit stops; test plug included	FP62327PF	158.15	1/2" Cold Exp. PEX	12
Three port; adj. temp. limit stops; quarter turn stops and test plug included	FP62328PF	189.45	1/2" Cold Exp. PEX	12

BULK Non-Pressure Balancing Showering

Must order in Case Quantity.

		MODEL	LIST FINISH	CASE QTY
CHATEAU®	ONE-HANDLE NON-PRESSURE BALANCED TUB/SHOWER TRIM			
	<ul style="list-style-type: none"> • showerhead: one-function • showerhead size: 2-1/2" diameter spray head • spout length: 5 1/2" • spout connection type: slip fit • tub spout type: diverter • red/blue markings: included • valve sold separately 	Flow Rate:	2.5 gpm (9.5 L/min) max	
		T471	91.35 Chrome	12
		Flow Rate:	1.75 gpm (6.65 L/min) max	
		T471EP	91.35 Chrome	12
<hr/>				
	<ul style="list-style-type: none"> • showerhead: one-function • showerhead size: 2-1/2" diameter spray head • spout length: 5 1/2" • spout connection type: slip fit • tub spout type: diverter • red/blue markings: included • valve sold separately 	Flow Rate:	2.5 gpm (9.5 L/min) max	
		TL471	91.35 Chrome	12
		Flow Rate:	1.75 gpm (6.65 L/min) max	
		TL471EP	91.35 Chrome	12

VALVE:
PAGE 471

HOW TO ORDER

TRIM
PART NO.



+

VALVE
PART NO.



=

COMPLETE
FAUCET









BULK



BULK Non-Pressure Balancing Showering

Must order in Case Quantity.

		MODEL	LIST	FINISH	CASE QTY
CHATEAU®	ONE-HANDLE NON-PRESSURE BALANCED SHOWER ONLY TRIM				
	<ul style="list-style-type: none"> showerhead: one-function showerhead size: 2-1/2" diameter spray head red/blue markings: included valve sold separately 	Flow Rate:	2.5 gpm (9.5 L/min) max		
		T473	56.40	Chrome	12
		Flow Rate:	1.75 gpm (6.65 L/min) max		
		T473EP	56.40	Chrome	12
	<ul style="list-style-type: none"> showerhead: one-function showerhead size: 2-1/2" diameter spray head red/blue markings: included valve sold separately 	Flow Rate:	2.5 gpm (9.5 L/min) max		
		TL473	56.40	Chrome	12
	 	Flow Rate:	1.75 gpm (6.65 L/min) max		
		TL473EP	56.40	Chrome	12

VALVE:
PAGE 471

HOW TO ORDER

TRIM
PART NO.



+

VALVE
PART NO.



=

COMPLETE
FAUCET



BULK



BULK Non-Pressure Balancing Showering

Must order in Case Quantity.

		MODEL	LIST	FINISH	CASE QTY
CHATEAU®	ONE-HANDLE NON-PRESSURE BALANCED VALVE ONLY TRIM				
	• valve sold separately	T470	47.30	Chrome	12



	• valve sold separately	TL470	47.30	Chrome	12
--	-------------------------	--------------	-------	--------	----



VALVE:
PAGE 471

HOW TO ORDER

TRIM
PART NO.



+

VALVE
PART NO.



=

COMPLETE
FAUCET



Non-Pressure Balanced Mixing Showering Rough-In Valves

(For product details, images, and bulk pack offering please reference page 471 in Valve section)

TUB/SHOWER OR SHOWER ONLY APPLICATION

Description	Model	List	Connection	Case Qty
Four port; non-pressure balanced mixing valve	62700	132.20	1/2" IPS	12
Four port; non-pressure balanced mixing valve	62720	132.20	1/2" CC	12

BULK

Commercial Products



Products that address your highest priorities.

From leaks and vandalism to normal wear and tear, worries never cease where commercial and institutional fixtures are concerned. That's why Moen® Commercial engineers and designers think of every imaginable scenario – and plan for it in advance. The result is a full line of faucets and valves every facilities manager can rely on from the number one faucet brand in North America.

Our products will help you:

- reduce maintenance costs
- resist vandalism
- save water while maintaining performance
- cut your total cost of ownership

On the pages ahead, we welcome you to discover all the reasons you can count on Moen Commercial to provide the best solutions for your most challenging environments.



M•POWER Sensor-Operated Faucet/8559BL
M•POWER Sensor-Operated Soap Dispenser/8560BL

Contents

614	M•DURA™ Heavy-Duty Faucet
626	M•PRESS™ Heavy-Duty Metering Faucets
628	M•BITION™ Medium-Duty Faucets
635	M•POWER™ Sensor-Operated Faucets
643	M•POWER™ Sensor-Operated Flush Valves
647	M•DURA™ Heavy-Duty Manual Flush Valves
650	M•DURA™ Heavy-Duty Showering
659	M•CORE™ Showering
662	Accessories and Service Kits
667	Suggested List Prices

We're here to help you meet every challenge.

Anticipating every need, your Moen® Commercial representative will help you find the right solutions that will serve you well for years. With our experienced guidance, you'll not only satisfy regulations and requirements, but also create aesthetically pleasing environments thanks to our trendsetting, residential-inspired styles.

Your representative is committed to ensuring your fixtures' suitability for demanding uses, as indicated by the following symbols:



Moen 5-Year Limited Warranty

We're so confident in the performance of our products that we back them with a 5-Year Limited Warranty. If they should ever drip, leak or prove to have a finish defect, we'll send you the replacement parts, free of charge. Just call 1-800-BUY-MOEN or see your Moen dealer for complete details.



With the growing demand for eco-friendly products, Moen Commercial offers many fixtures whose water savings exceed industry standards.



With very few exceptions, fixtures from Moen Commercial comply with the Americans with Disabilities Act (ADA).



A wide range of our products meet the current requirements of the Buy American Act (BAA).



We offer many products which meet WaterSense® criteria to contribute toward meeting LEED® standards and maximizing LEED points*. While helping you achieve ambitious environmental standards, Moen Commercial can also help you ensure essential function. For instance, installing extremely low-flow fixtures that save water could end up being costlier elsewhere. Without enough water pressure to clear pipes of solids, performance, maintenance and sanitation can quickly become serious issues. Exceedingly low-flow fixtures also provide consumers with a disappointing experience. Being LEED certified doesn't mean sacrificing performance to save water. With the guidance of a Moen Commercial representative, you can build beautifully efficient properties without increasing health risks and downgrading the consumer experience.

* Projects pursuing LEED certification earn points across several areas that address sustainability issues, and based on the number of points achieved, a project receives one of four LEED rating levels: Certified, Silver, Gold or Platinum.

Moen products comply with the Safe Drinking Water Act's stringent lead safety standards.

Each product in this catalog has been identified by the following icons where applicable:

- ▲ NSF 61/9 and 372 compliant
- NSF 372 compliant
- Non-drinking water faucet















To see our full line of faucets and valves, visit moencommercial.com.

M•DURA™ Heavy-Duty Faucets





M•DURA™ Single-Mount Lavatory Faucet / 9417 & 9419 Series

M•DURA™ Heavy-Duty Faucets

	MODEL	LIST	FINISH/CONNECT	CASE QTY
ONE-HANDLE SINGLE-MOUNT LAVATORY FAUCET				
 <ul style="list-style-type: none"> • connection size: 3/8" compression • vandal resistant: yes • cartridge type: 1255® Duralast® • flow type: vandal resistant aerated • mount type: single mount • supply length: 22" • deckplate: sold separately • temp. limit stop: yes • drain assembly not included • no lift rod hole • lever handle • material: brass <p>  DURALAST®   </p>	<p>▲ 1.2 GPM (4.5 L/min) max.</p> <p>9417F12 274.75 Chrome 3</p> <p>● 0.5 GPM (1.9 L/min) max.</p> <p>9417F05 274.75 Chrome 3</p> <p>4" DECKPLATE SOLD SEPARATELY</p> <p>99559 37.15 Chrome 20</p>			
	 <ul style="list-style-type: none"> • connection size: 3/8" compression • vandal resistant: yes • cartridge type: 1255® Duralast® • flow type: vandal resistant aerated • mount type: single mount • supply length: 22" • deckplate: sold separately • temp. limit stop: yes • drain assembly: metal • lever handle • material: brass <p>  DURALAST®   </p>	<p>▲ 1.2 GPM (4.5 L/min) max.</p> <p>9419F12 305.30 Chrome 3</p> <p>● 0.5 GPM (1.9 L/min) max.</p> <p>9419F05 305.30 Chrome 3</p> <p>4" DECKPLATE SOLD SEPARATELY</p> <p>99559 37.15 Chrome 20</p>		
		 <ul style="list-style-type: none"> • connection size: 3/8" compression • cartridge type: ceramic disc • flow type: aerated • mount type: single mount • supply length: 22" • temp. limit stop: yes • drain assembly not included • no lift rod hole • lever handle • material: brass <p>   </p>	<p>▲ 1.2 GPM (4.5 L/min) max.</p> <p>8417F12 248.30 Chrome 6</p> <p>● 0.5 GPM (1.9 L/min) max.</p> <p>8417F05 248.30 Chrome 6</p>	
			 <ul style="list-style-type: none"> • connection size: 3/8" compression • cartridge type: ceramic disc • flow type: aerated • mount type: single mount • supply length: 22" • temp. limit stop: yes • drain assembly: metal • lever handle • material: brass <p>   </p>	<p>▲ 1.2 GPM (4.5 L/min) max.</p> <p>8419F12 282.05 Chrome 6</p> <p>● 0.5 GPM (1.9 L/min) max.</p> <p>8419F05 282.05 Chrome 6</p>















COMMERCIAL

M•DURA™ Heavy-Duty Faucets

	MODEL	LIST	FINISH/CONNECT	CASE QTY
ONE-HANDLE CENTERSET LAVATORY FAUCET				
 <ul style="list-style-type: none"> • connection size: 1/2" IPS • cartridge type: ceramic disc • flow type: aerated • mount type: center set • temp. limit stop: yes • drain assembly not included • no lift rod hole • lever handle • material: brass <p>ADA compliant</p>	<p>1.2 GPM (4.5 L/min) max.</p> <p>8413F12</p>	179.75	Chrome	3
	<p>0.5 GPM (1.9 L/min) max.</p> <p>8413F05</p>	179.75	Chrome	3
	<p>0.35 GPM (1.32 L/min) max.</p> <p>8413F03</p>	179.75	Chrome	3
 <ul style="list-style-type: none"> • connection size: 1/2" IPS • cartridge type: ceramic disc • flow type: aerated • mount type: center set • temp. limit stop: yes • drain assembly: metal • lever handle • material: brass <p>ADA compliant</p>	<p>2.2 GPM (8.3 L/min) max.</p> <p>8414</p>	214.50	Chrome	6
	<p>1.2 GPM (4.5 L/min) max.</p> <p>8414F12</p>	214.50	Chrome	3
	<p>8414F12BN</p>	268.15	Brushed Nickel	3
 <ul style="list-style-type: none"> • connection size: 1/2" IPS • vandal resistant: yes • cartridge type: ceramic hot/cold • flow type: vandal resistant aerated • mount type: center set • temp. limit stop: yes • drain assembly not included • no lift rod hole • lever handle • material: brass <p>ADA compliant</p>	<p>2.2 GPM (8.3 L/min) max.</p> <p>8416</p>	193.05	Chrome	6
	<p>0.5 GPM (1.9 L/min) max.</p> <p>8416F05</p>	193.05	Chrome	3
WIDESPREAD LAVATORY FAUCET				
 <ul style="list-style-type: none"> • connection size: 1/2" IPS • vandal resistant: yes • cartridge type: ceramic hot/cold • flow type: vandal resistant aerated • mount type: widespread • drain assembly not included • no lift rod hole • lever handle • material: brass <p>ADA compliant, NSF 61/9 and 372 compliant, NSF 372 compliant</p>	<p>0.5 GPM (1.9 L/min) max.</p> <p>8220F05</p>	328.75	Chrome	3
	<p>8228F12</p>	349.50	Chrome	3
 <ul style="list-style-type: none"> • connection size: 1/2" IPS • vandal resistant: yes • cartridge type: ceramic hot/cold • flow type: vandal resistant aerated • mount type: widespread • drain assembly not included • no lift rod hole • wrist blade handle • material: brass <p>ADA compliant, NSF 61/9 and 372 compliant, NSF 372 compliant</p>	<p>1.2 GPM (4.5 L/min) max.</p> <p>8228F12</p>	349.50	Chrome	3
	<p>0.5 GPM (1.9 L/min) max.</p> <p>8228F05</p>	349.50	Chrome	3

COMMERCIAL

M•DURA™ Heavy-Duty Faucets

		MODEL	LIST	FINISH/CONNECT	CASE QTY		
TWO-HANDLE CENTERSET LAVATORY FAUCET							
 <ul style="list-style-type: none"> • connection size: 1/2" IPS • vandal resistant: yes • cartridge type: ceramic hot/cold • flow type: vandal resistant aerated • mount type: centerset • drain assembly not included • no lift rod hole • lever handle • material: brass <p>    </p>	<ul style="list-style-type: none"> • connection size: 1/2" IPS • vandal resistant: yes • cartridge type: ceramic hot/cold • flow type: vandal resistant aerated • mount type: centerset • drain assembly not included • no lift rod hole • smooth lever handle • material: brass <p>    </p>	<ul style="list-style-type: none"> • connection size: 1/2" IPS • vandal resistant: yes • cartridge type: ceramic hot/cold • flow type: vandal resistant aerated • mount type: centerset • drain assembly not included • no lift rod hole • wrist blade handle • material: brass <p>    </p>	<ul style="list-style-type: none"> • connection size: 1/2" IPS • vandal resistant: yes • cartridge type: ceramic hot/cold • flow type: vandal resistant aerated • mount type: centerset • drain assembly not included • no lift rod hole • smooth wrist blade handle • material: brass <p>    </p>	<p>▲ 1.2 GPM (4.5 L/min) max.</p> <p>8210F12 209.90 Chrome 6</p> <p>◆ 0.5 GPM (1.9 L/min) max.</p> <p>8210F05 209.90 Chrome 6</p>	<p>▲ 1.2 GPM (4.5 L/min) max.</p> <p>8210SMF12 209.90 Chrome 6</p> <p>◆ 0.5 GPM (1.9 L/min) max.</p> <p>8210SMF05 209.90 Chrome 6</p>	<p>▲ 1.2 GPM (4.5 L/min) max.</p> <p>8215F12 232.75 Chrome 6</p> <p>◆ 0.5 GPM (1.9 L/min) max.</p> <p>8215F05 232.75 Chrome 6</p> <p>◆ 0.35 GPM (1.32 L/min) max.</p> <p>8215F03 232.75 Chrome 6</p>	<p>▲ 1.2 GPM (4.5 L/min) max.</p> <p>8215SMF12 232.75 Chrome 6</p>
	MANUAL-TO-METERING CONVERSION KIT						
	 <ul style="list-style-type: none"> • excludes 8242, 8244 and modern lavs • includes hot/cold color indicator rings 	<p>52120 175.60 Chrome 12</p>					

COMMERCIAL

M•DURA™ Heavy-Duty Faucets







MODEL LIST FINISH/CONNECT CASE QTY

TWO-HANDLE CENTERSET GOOSENECK FAUCET				
 <ul style="list-style-type: none"> • connection size: 1/2" IPS • vandal resistant: yes • cartridge type: ceramic hot/cold • spout reach: 3.60" • flow type: vandal resistant laminar • mount type: centerset • drain assembly not included • no lift rod hole • lever handle • material: brass 	<p>1.2 GPM (4.5 L/min) max.</p>			
	8270	249.65	Chrome	6
 <ul style="list-style-type: none"> • connection size: 1/2" IPS • vandal resistant: yes • cartridge type: ceramic hot/cold • spout reach: 3.60" • flow type: vandal resistant laminar • mount type: centerset • drain assembly not included • wrist blade handle • material: brass 	<p>1.2 GPM (4.5 L/min) max.</p>			
	8278	263.05	Chrome	6
 <ul style="list-style-type: none"> • connection size: 1/2" IPS • vandal resistant: yes • cartridge type: ceramic hot/cold • spout reach: 3.60" • flow type: vandal resistant laminar • mount type: centerset • drain assembly not included • smooth wrist blade handle • material: brass 	<p>2.2 GPM (8.3 L/min) max.</p>			
	8278SM	263.05	Chrome	6
	<p>1.2 GPM (4.5 L/min) max.</p>			
8278SMF12	263.05	Chrome	6	
 <ul style="list-style-type: none"> • connection size: 1/2" IPS • vandal resistant: yes • cartridge type: ceramic hot/cold • spout reach: 5.25" • flow type: vandal resistant laminar • mount type: centerset • drain assembly not included • wrist blade handle • material: brass 	<p>1.2 GPM (4.5 L/min) max.</p>			
	8279	284.65	Chrome	6
 <ul style="list-style-type: none"> • connection size: 1/2" IPS • vandal resistant: yes • cartridge type: ceramic hot/cold • spout reach: 5.25" • flow type: vandal resistant laminar • mount type: centerset • drain assembly not included • smooth wrist blade handle • material: brass 	<p>2.2 GPM (8.3 L/min) max. aerated</p>			
	8279SM	279.90	Chrome	6
	<p>2.0 GPM (7.6 L/min) max. laminar</p>			
8279SMF12	279.90	Chrome	6	
 <ul style="list-style-type: none"> • connection size: 1/2" IPS • spout not included • vandal resistant: yes • cartridge type: ceramic hot/cold • mount type: centerset • drain assembly not included • wrist blade handle • material: brass 	<p>1.2 GPM (4.5 L/min) max.</p>			
	8276	224.10	Chrome	6

COMMERCIAL

▲ NSF 61/9 and 372 compliant ● NSF 372 compliant ■ Non-drinking water faucet

M•DURA™ Heavy-Duty Faucets

	MODEL	LIST	FINISH/CONNECT	CASE QTY
WIDESPREAD GOOSENECK FAUCET				
	8248	334.30	Chrome	6
<ul style="list-style-type: none"> • connection size: 1/2" IPS • vandal resistant: yes • cartridge type: ceramic hot/cold • spout reach: 5.25" • flow type: aerated • mount type: widespread • drain assembly not included • wrist blade handle • material: brass 	1.2 GPM (4.5 L/min) max.			
	8248SMF12	334.30	Chrome	3
<ul style="list-style-type: none"> • connection size: 1/2" IPS • vandal resistant: yes • cartridge type: ceramic hot/cold • spout reach: 5.25" • flow type: aerated • mount type: widespread • drain assembly not included • smooth wrist blade handle • material: brass 	1.2 GPM (4.5 L/min) max.			
	8225	341.35	Chrome	6
<ul style="list-style-type: none"> • connection size: 1/2" IPS • vandal resistant: yes • cartridge type: ceramic hot/cold • spout reach: 8.00" • flow type: aerated • mount type: widespread • drain assembly not included • wrist blade handle • material: brass 	1.5 GPM (5.7 L/min) max.			
	8225SMF15	341.35	Chrome	3
<ul style="list-style-type: none"> • connection size: 1/2" IPS • vandal resistant: yes • cartridge type: ceramic hot/cold • spout reach: 8.00" • flow type: vandal resistant aerated • mount type: widespread • drain assembly not included • smooth wrist blade handle • material: brass 	1.5 GPM (5.7 L/min) max. aerated 1.5 GPM (5.7 L/min) max. laminar			
	8229	284.60	Chrome	6
<ul style="list-style-type: none"> • connection size: 1/2" IPS • spout not included • vandal resistant: yes • cartridge type: ceramic hot/cold • mount type: widespread • drain assembly not included • wrist blade handle • material: brass 				
	8227	320.60	Chrome	6
<ul style="list-style-type: none"> • connection size: 1/2" IPS • vandal resistant: yes • cartridge type: ceramic hot/cold • spout reach: 8.00" • flow type: vandal resistant aerated • mount type: widespread • drain assembly not included • lever handle • material: brass 	1.5 GPM (5.7 L/min) max.			
	8226	263.75	Chrome	6
<ul style="list-style-type: none"> • connection size: 1/2" IPS • spout not included • vandal resistant: yes • cartridge type: ceramic hot/cold • mount type: widespread • drain assembly not included • lever handle • material: brass 				

COMMERCIAL

▲ NSF 61/9 and 372 compliant ● NSF 372 compliant ■ Non-drinking water faucet

M•DURA™ Heavy-Duty Kitchen Faucets

















MODEL LIST FINISH/CONNECT CASE QTY

TWO-HANDLE KITCHEN FAUCET				
	<ul style="list-style-type: none"> • connection size: 1/2" IPS • vandal resistant: yes • cartridge type: ceramic hot/cold • spout reach: 8.00" • flow type: aerated • mount type: widespread • side spray included • drain assembly not included • lever handle • material: brass 	1.5 GPM (5.7 L/min) max.		
		8242	367.70	Chrome 6
	<ul style="list-style-type: none"> • connection size: 1/2" IPS • vandal resistant: yes • cartridge type: ceramic hot/cold • spout reach: 8.00" • flow type: aerated • mount type: widespread • side spray included • drain assembly not included • wrist blade handle • material: brass 	1.5 GPM (5.7 L/min) max.		
		8244	388.40	Chrome 6
	<ul style="list-style-type: none"> • connection size: 1/2" IPS • vandal resistant: yes • cartridge type: ceramic hot/cold • spout reach: 8.00" • flow type: aerated • drain assembly not included • lever handle • material: brass 	1.5 GPM (5.7 L/min) max.		
		8287	315.10	Chrome 6
	<ul style="list-style-type: none"> • connection size: 1/2" IPS • spout not included • vandal resistant: yes • cartridge type: ceramic hot/cold • drain assembly not included • lever handle • material: brass 			
		8280	252.80	Chrome 6
	<ul style="list-style-type: none"> • connection size: 1/2" IPS • vandal resistant: yes • cartridge type: ceramic hot/cold • spout reach: 8.00" • flow type: aerated • drain assembly not included • wrist blade handle • material: brass 	1.5 GPM (5.7 L/min) max.		
		8289	335.75	Chrome 6
	<ul style="list-style-type: none"> • connection size: 1/2" IPS • spout not included • vandal resistant: yes • cartridge type: ceramic hot/cold • drain assembly not included • wrist blade handle • material: brass 			
		8285	273.55	Chrome 6

COMMERCIAL





▲ NSF 61/9 and 372 compliant ● NSF 372 compliant ■ Non-drinking water faucet

M•DURA™ Heavy-Duty Kitchen Faucets

	MODEL	LIST	FINISH/CONNECT	CASE QTY
ONE-HANDLE KITCHEN FAUCET				
 <ul style="list-style-type: none"> • connection size: 3/8" compression • vandal resistant: yes • cartridge type: 1255® Duralast® • spout reach 9.00" • flow type: aerated • supply length: 22" • temp. limit stop: yes • side spray: yes • drain assembly not included • lever handle • material: brass <p>  DURALAST®   </p>	<p>1.5 GPM (5.7 L/min) max.</p> <p>8707 184.90 Chrome 6</p>			
	 <ul style="list-style-type: none"> • connection size: 3/8" compression • vandal resistant: yes • cartridge type: 1255® Duralast® • spout reach 12.00" • flow type: aerated • supply length: 22" • temp. limit stop: yes • side spray: yes • drain assembly not included • lever handle • material: brass <p>  DURALAST®   </p>	<p>1.5 GPM (5.7 L/min) max.</p> <p>8717 274.05 Chrome 6</p>		
 <ul style="list-style-type: none"> • connection size: 3/8" compression • vandal resistant: yes • cartridge type: 1255® Duralast® • spout reach 9.00" • flow type: aerated • supply length: 22" • temp. limit stop: yes • drain assembly not included • lever handle • material: brass <p>  DURALAST®   </p>		<p>1.5 GPM (5.7 L/min) max.</p> <p>8701 155.20 Chrome 12</p>		
	ONE-HANDLE WALLMOUNT KITCHEN FAUCET			
 <ul style="list-style-type: none"> • connection size: 1/2" eccentric; IPS • vandal resistant: yes • cartridge type: 1255® Duralast® • spout reach 9.00" • flow type: aerated • mount type: wallmount • temp. limit stop: yes • drain assembly not included • lever handle • material: brass <p>  DURALAST®   </p>	<p>1.5 GPM (5.7 L/min) max.</p> <p>8713 465.70 Chrome 12</p>			

M•DURA™ Heavy-Duty Multi-Purpose Faucets





















MODEL LIST FINISH/CONNECT CASE QTY

ONE-HANDLE MULTI-PURPOSE FAUCET				
	<ul style="list-style-type: none"> • connection size: 3/8" compression • vandal resistant: yes • cartridge type: 1255® Duralast® • flow type: aerated • mount type: widespread • supply length: 22" • temp. limit stop: yes • side spray: yes • drain assembly not included • lever handle • material: brass 	<p>1.5 GPM (5.7 L/min) max.</p>		
	8138	305.40	Chrome	6
	<ul style="list-style-type: none"> • connection size: 3/8" compression • vandal resistant: yes • cartridge type: 1255® Duralast® • flow type: aerated • mount type: widespread • supply length: 22" • temp. limit stop: yes • drain assembly not included • lever handle • material: brass 	<p>1.5 GPM (5.7 L/min) max.</p>		
	8137	256.55	Chrome	6
TWO-HANDLE CENTERSET UTILITY FAUCET				
	<ul style="list-style-type: none"> • connection size: 1/2" IPS • 3/4" garden hose thread • vandal resistant: yes • cartridge type: ceramic hot/cold • spout reach: 6.50" • flow type: vandal resistant aerated • mount type: centerset • drain assembly not included • lever handle • material: brass 	<p>Unrestricted</p>		
	8277	227.10	Chrome	6
TWO-HANDLE WALLMOUNT UTILITY FAUCET				
	<ul style="list-style-type: none"> • connection size: 1/2" eccentric; IPS • vandal resistant: yes • cartridge type: ceramic hot/cold • spout reach 12.00" • flow type: aerated • mount type: wallmount • drain assembly not included • lever handle • material: brass 	<p>1.5 GPM (5.7 L/min) max.</p>		
	8119	317.75	Chrome	6
	<ul style="list-style-type: none"> • connection size: 1/2" eccentric; IPS • vandal resistant: yes • cartridge type: ceramic hot/cold • spout reach 8.00" • flow type: aerated • mount type: wallmount • drain assembly not included • wrist blade handle • material: brass 	<p>1.5 GPM (5.7 L/min) max.</p>		
	8126	318.60	Chrome	6

COMMERCIAL



▲ NSF 61/9 and 372 compliant ● NSF 372 compliant ■ Non-drinking water faucet

M•DURA™ Heavy-Duty Multi-Purpose and Laboratory Faucets

	MODEL	LIST	FINISH/CONNECT	CASE QTY
TWO-HANDLE WALLMOUNT SERVICE SINK FAUCET				
 <ul style="list-style-type: none"> • connection size: 1/2" eccentric IPS • 3/4" garden hose thread • vandal resistant: yes • cartridge type: ceramic hot/cold • spout reach: 9.38" • mount type: wallmount • wall bracket and vacuum breaker included • pail hook included • drain assembly not included • lever handle • material: brass <p>    </p>	Unrestricted			
	8230	218.45	Chrome	3
 <ul style="list-style-type: none"> • connection size: 1/2" eccentric IPS • 3/4" garden hose thread • vandal resistant: yes • cartridge type: ceramic hot/cold • spout reach: 10.25" • mount type: wallmount • wall bracket, vacuum breaker, and backflow preventers included • pail hook included • drain assembly not included • lever handle • material: brass <p>    </p>	Unrestricted			
	8124	269.30	Chrome	6
ONE-HANDLE LABORATORY FAUCET				
 <ul style="list-style-type: none"> • connection size: 3/8" compression • vandal resistant: yes • cartridge type: ceramic hot/cold • spout reach: 5.25" • flow type: aerated • mount type: single mount • supply length: 22" • cold only: yes • drain assembly not included • lever handle • material: brass <p>    </p>	2.2 GPM (8.3 L/min) max.			
	8103	182.95	Chrome	6
TWO-HANDLE LABORATORY FAUCET				
 <ul style="list-style-type: none"> • connection size: 3/8" compression • vandal resistant: yes • cartridge type: ceramic hot/cold • spout reach: 5.25" • flow type: aerated • mount type: single mount • supply length: 22" • drain assembly not included • lever handle • material: brass <p>    </p>	2.2 GPM (8.3 L/min) max.			
	8113	271.05	Chrome	6
 <ul style="list-style-type: none"> • connection size: 3/8" compression • serrated hose nozzle • vandal resistant: yes • cartridge type: ceramic hot/cold • spout reach: 6.00" • mount type: single mount • supply length: 22" • vacuum braker included • drain assembly not included • lever handle • material: brass <p>    </p>	Unrestricted			
	8116	335.10	Chrome	6

COMMERCIAL

M•DURA™ Heavy-Duty Spouts

		MODEL	LIST	FINISH/CONNECT	CASE QTY		
DOUBLE-BEND SPOUTS							
	Model Number	Reach	Base to Aerator*	Overall Height	Weight Each Pounds	Case Quantity	List Price
 <p>S0003</p>  <p>S0010</p>	S0000 ▲	6.00"	2.00"	4.325"	0.89	12	55.35
	S0001 ▲	6.00"	3.75"	7.375"	1.20	12	66.55
	S0002 ▲	6.00"	5.00"	9.125"	1.64	12	67.95
	S0003 ▲	6.00"	5.75"	9.75"	1.60	12	66.55
	S0004 ▲	6.00"	8.50"	12.75"	1.71	12	79.95
	S0007 ▲	8.00"	6.00"	9.75"	1.90	12	67.95
	S0009 ▲	10.00"	5.75"	9.75"	2.20	12	73.25
	S0010 ▲	12.00"	0.50"	3.125"	1.40	12	79.95
	S0011 ▲	12.00"	6.00"	9.75"	1.64	12	66.55

MULTI-BEND SPOUTS							
	Model Number	Reach	Base to Aerator*	Overall Height	Weight Each Pounds	Case Quantity	List Price
	S0012 ▲	18.00"	3.75"	7.75"	2.40	12	145.30

VACUUM-BREAKER SPOUTS							
	Model Number	Reach	Base to Aerator*	Overall Height	Weight Each Pounds	Case Quantity	List Price
 <p>SV003</p>	SV003 ■	6.00"	5.75"	10.50"	2.15	12	137.25
	SV006 ■	8.00"	0.50"	4.00"	1.40	12	127.95
	SV010 ■	12.00"	0.50"	4.00"	1.70	12	134.60

All spouts include 2.2 gpm [8.3 lpm] max. aerators (except as noted below). Spouts are designed for use only with 8100 and 8200 series aerators.

* Height from spout nut base plane to aerator

** Threaded-end gooseneck spouts - spout tip is threaded, no aerator included





*** Smooth-end gooseneck spouts - spout tip is smooth and will not take an aerator; flow is controlled by 1.5gpm laminar flow spout base insert.

▲ NSF 61/9 and 372 compliant ● NSF 372 compliant ■ Non-drinking water faucet





♿ ADA compliant ♻️ BAA compliant 💧 WaterSense® ♻️ Water-saving

M•DURA™ Heavy-Duty Spouts

GOOSENECK SPOUTS

Model Number	Reach	Base to Aerator*	Overall Height	Weight Each Pounds	Case Quantity	List Price
 S0030	3.625"	6.25"	8.75"	1.47	12	67.95
 S0060	5.25"	5.50"	10.00"	1.55	12	74.65
 S0050	8.00"	6.125"	11.375"	1.65	12	82.60
 S0060	8.00"	10.00"	12.00"	1.10	12	102.65
 S0070	9.50"	6.50"	9.175"	1.81	12	89.30

THREADED-END GOOSENECK SPOUTS

Model Number	Reach	Base to Aerator**	Overall Height	Weight Each Pounds	Case Quantity	List Price
 S0050T	5.25"	N/A	10.00"	1.55	12	57.55
 S0050T	8.00"	N/A	11.375"	1.85	12	65.50
 S0000T						
 S0010T						

SMOOTH-END GOOSENECK SPOUTS

Model Number	Reach	Base to Aerator***	Overall Height	Weight Each Pounds	Case Quantity	List Price
 S0030NA	5.25"	N/A	10.00"	1.15	6	76.90

LAMINAR FLOW KITS

Model Number	Description	List Price
 52655	laminar flow spout, flow control in base spout, 0.5 gpm (1.9 L/m)	20.15
52652	laminar flow spout, flow control in base spout, 1.5 gpm (5.7 L/m)	32.05
52653	laminar flow spout, flow control in base spout, 1.0 gpm (3.8 L/m)	33.45

All spouts include 2.2 gpm [8.3 lpm] max. aerators (except as noted below). Spouts are designed for use only with 8100 and 8200 series aerators.







- * Height from spout nut base plane to aerator
- ** Threaded-end gooseneck spouts – spout tip is threaded, no aerator included
- *** Smooth-end gooseneck spouts – spout tip is smooth and will not take an aerator; flow is controlled by 1.5gpm laminar flow spout base insert.

M•PRESS™ Heavy-Duty Metering Faucets



M•PRESS™ Single-Mount Metering Faucet / 8884

M•PRESS™ Heavy-Duty Metering Faucets

	MODEL	LIST	FINISH/CONNECT	CASE QTY
ECO-PERFORMANCE SINGLE-MOUNT METERING FAUCET				
 <ul style="list-style-type: none"> • connection size: 1/2" IPS • vandal resistant: yes • flow type: vandal resistant multi laminar • mount type: single mount • timing preset: yes • drain assembly not included • material: brass 	Ø 0.5 GPM (1.9 L/min) max.			
	8884	189.05	Chrome	6
4" DECKPLATE SOLD SEPARATELY				
	99550	33.95	Chrome	12
ECO-PERFORMANCE SINGLE-MOUNT EXTENDED REACH METERING FAUCET				
 <ul style="list-style-type: none"> • connection size: 1/2" IPS • vandal resistant: yes • flow type: vandal resistant multi laminar • mount type: single mount • timing preset: yes • drain assembly not included • material: brass 	Ø 0.5 GPM (1.9 L/min) max.			
	8894	214.65	Chrome	6
4" DECKPLATE SOLD SEPARATELY				
	99551	33.95	Chrome	12
ECO-PERFORMANCE CENTERSET METERING FAUCET				
 <ul style="list-style-type: none"> • connection size: 1/2" IPS • vandal resistant: yes • flow type: vandal resistant multi laminar • mount type: centerset • timing preset: yes • drain assembly not included • material: brass 	Ø 0.5 GPM (1.9 L/min) max.			
	8886	348.45	Chrome	6
ECO-PERFORMANCE WIDESPREAD METERING FAUCET				
 <ul style="list-style-type: none"> • connection size: 1/2" IPS • vandal resistant: yes • flow type: vandal resistant multi laminar • mount type: widespread • timing preset: yes • drain assembly not included • material: brass 	Ø 0.5 GPM (1.9 L/min) max.			
	8889	446.00	Chrome	6
DURAMETER METERING CARTRIDGE				
 <ul style="list-style-type: none"> • brass pressure-independent replacement cartridge 	52100	94.60	N/A or Unfinished	24
MANUAL-TO-METERING CONVERSION KIT				
 <ul style="list-style-type: none"> • excludes 8242, 8244 and modern lavs • includes hot/cold color indicator rings 	52120	175.60	Chrome	12









COMMERCIAL

M•BITION™ Medium-Duty Faucets



M•BITION™ Single-Handle Lavatory Faucet / 8430 Series

M•BITION™ Medium-Duty Lavatory Faucets



	MODEL	LIST	FINISH/CONNECT	CASE QTY
SINGLE-MOUNT LAVATORY FAUCET				
 <ul style="list-style-type: none"> • connection size: 3/8" compression • vandal resistant: yes • cartridge type: 1255® Duralast® • flow type: vandal resistant aerated • mount type: single mount • supply length: 24" • temp. limit stop: yes • drain assembly not included • no lift rod hole • lever handle <p> DURALAST  </p>	▲ 1.2 GPM (4.5 L/min) max.			
	9480	170.05	Chrome	3
	4" DECKPLATE SOLD SEPARATELY			
	99559	37.15	Chrome	20
 <ul style="list-style-type: none"> • connection size: 3/8" compression • vandal resistant: yes • cartridge type: 1255® Duralast® • flow type: vandal resistant aerated • mount type: single mount • supply length: 24" • temp. limit stop: yes • drain assembly: metal • lever handle <p> DURALAST  </p>	▲ 1.2 GPM (4.5 L/min) max.			
	9482	188.95	Chrome	3
	4" DECKPLATE SOLD SEPARATELY			
	99559	37.15	Chrome	20

COMMERCIAL

M•BITION™ Medium-Duty Lavatory Faucets

























	MODEL	LIST	FINISH/CONNECT	CASE QTY
ONE-HANDLE CENTERSET LAVATORY FAUCET				
 <ul style="list-style-type: none"> • connection size: 1/2" IPS • vandal resistant: yes • cartridge type: 1255® Duralast® • flow type: vandal resistant aerated • mount type: centerset • temp. limit stop: yes • drain assembly not included • removable plug button in lift rod hole • lever handle <p>DURALAST®   </p>	<p>1.2 GPM (4.5 L/min) max.</p> <p>8400</p>	188.20	Chrome	12
	 <ul style="list-style-type: none"> • connection size: 1/2" IPS • vandal resistant: yes • cartridge type: 1255® Duralast® • flow type: vandal resistant aerated • mount type: centerset • temp. limit stop: yes • drain assembly: metal • lever handle <p>DURALAST®  </p>	<p>1.2 GPM (4.5 L/min) max.</p> <p>8420</p>	218.40	Chrome
 <ul style="list-style-type: none"> • connection size: 1/2" IPS • vandal resistant: yes • cartridge type: 1255® Duralast® • flow type: vandal resistant aerated • mount type: centerset • temp. limit stop: yes • drain assembly: grid strainer waste • lever handle <p>DURALAST®  </p>		<p>1.2 GPM (4.5 L/min) max.</p> <p>8425</p>	212.65	Chrome
	 <ul style="list-style-type: none"> • connection size: 3/8" compression • vandal resistant: yes • cartridge type: 1255® Duralast® • flow type: vandal resistant aerated • mount type: centerset • supply length: flexible • temp. limit stop: yes • drain assembly not included • removable plug button in lift rod hole • lever handle <p>DURALAST®  </p>	<p>1.2 GPM (4.5 L/min) max.</p> <p>8422</p>	197.45	Chrome
 <ul style="list-style-type: none"> • connection size: 1/2" IPS • vandal resistant: yes • cartridge type: 1255® Duralast® • flow type: vandal resistant aerated • mount type: centerset • temp. limit stop: yes • drain assembly not included • removable plug button in lift rod hole • lever handle <p>DURALAST®  </p>		<p>0.5 GPM (1.9 L/min) max.</p> <p>8422F05</p>	197.45	Chrome
	<p>1.2 GPM (4.5 L/min) max.</p> <p>8430</p>	147.15	Chrome	12
	<p>1.2 GPM (4.5 L/min) max.</p> <p>8430CBN</p>	183.95	Classic Brushed Nickel	12
 <ul style="list-style-type: none"> • connection size: 1/2" IPS • vandal resistant: yes • cartridge type: 1255® Duralast® • flow type: vandal resistant aerated • mount type: centerset • temp. limit stop: yes • drain assembly: metal • lever handle <p>DURALAST®  </p>	<p>0.5 GPM (1.9 L/min) max.</p> <p>8430F05</p>	147.15	Chrome	12
	<p>1.2 GPM (4.5 L/min) max.</p> <p>8432</p>	181.10	Chrome	12
 <ul style="list-style-type: none"> • connection size: 1/2" IPS • vandal resistant: yes • cartridge type: 1255® Duralast® • flow type: vandal resistant aerated • mount type: centerset • temp. limit stop: yes • drain assembly: metal • lever handle <p>DURALAST®  </p>	<p>0.5 GPM (1.9 L/min) max.</p> <p>8432F05</p>	181.10	Chrome	12

M•BITION™ Medium-Duty Lavatory Faucets

		MODEL	LIST	FINISH/CONNECT	CASE QTY
ONE-HANDLE CENTERSET LAVATORY FAUCET (CONTINUED)					
 <ul style="list-style-type: none"> • connection size: 1/2" IPS • vandal resistant: yes • cartridge type: 1255® Duralast® • flow type: vandal resistant aerated • mount type: centerset • temp. limit stop: yes • drain assembly: grid strainer waste • removable plug button in lift rod hole • lever handle 	<ul style="list-style-type: none"> • DURALAST® 	1.2 GPM (4.5 L/min) max.			
		8434	174.60	Chrome	12
 <ul style="list-style-type: none"> • connection size: 3/8" compression • vandal resistant: yes • cartridge type: 1255® Duralast® • flow type: vandal resistant aerated • mount type: centerset • supply length: flexible • temp. limit stop: yes • drain assembly not included • removable plug button in lift rod hole • lever handle 	<ul style="list-style-type: none"> • DURALAST® 	1.2 GPM (4.5 L/min) max.			
		8439	156.65	Chrome	12
		0.5 GPM (1.9 L/min) max.			
8439F05	156.65	Chrome	12		
 <ul style="list-style-type: none"> • connection size: 3/8" compression • vandal resistant: yes • cartridge type: 1255® Duralast® • flow type: vandal resistant aerated • mount type: centerset • supply length: flexible • temp. limit stop: yes • drain assembly: metal • lever handle 	<ul style="list-style-type: none"> • DURALAST® 	1.2 GPM (4.5 L/min) max.			
		8437	190.55	Chrome	12
		8437CBN	238.20	Classic Brushed Nickel	12





COMMERCIAL

M•BITION™ Medium-Duty Lavatory Faucets

	MODEL	LIST	FINISH/CONNECT	CASE QTY
WIDESPREAD LAVATORY FAUCET				
 <ul style="list-style-type: none"> • connection size: 1/2" IPS • vandal resistant: yes • cartridge type: 1244 • flow type: aerated • mount type: widespread • drain type: lift rod • drain assembly: metal • lever handle   	<p>1.2 GPM (4.5 L/min) max.</p> <p>8922</p>	270.65	Chrome	6
	<p>1.2 GPM (4.5 L/min) max.</p> <p>8924</p>	289.60	Chrome	6
 <ul style="list-style-type: none"> • connection size: 1/2" IPS • vandal resistant: yes • cartridge type: 1244 • flow type: aerated • mount type: widespread • drain assembly: grid strainer waste • lever handle   	<p>1.2 GPM (4.5 L/min) max.</p> <p>8800</p>	174.65	Chrome	6
	<p>0.5 GPM (1.9 L/min) max.</p> <p>8800F05</p>	174.65	Chrome	6
TWO-HANDLE CENTERSET LAVATORY FAUCET				
 <ul style="list-style-type: none"> • connection size: 1/2" IPS • vandal resistant: yes • cartridge type: 1244 • flow type: vandal resistant aerated • mount type: centerpiece • drain assembly not included • removable plug button in lift rod hole • wrist blade handle   	<p>1.2 GPM (4.5 L/min) max.</p> <p>8810</p>	200.25	Chrome	6
	<p>1.2 GPM (4.5 L/min) max.</p> <p>8820</p>	206.30	Chrome	6
 <ul style="list-style-type: none"> • connection size: 1/2" IPS • vandal resistant: yes • cartridge type: 1244 • flow type: vandal resistant aerated • mount type: centerpiece • drain assembly: grid drain waste • removable plug button in lift rod hole • wrist blade handle   	<p>1.2 GPM (4.5 L/min) max.</p> <p>8915</p>	128.40	Chrome	12
	<p>1.2 GPM (4.5 L/min) max.</p> <p>8917</p>	151.35	Chrome	12
 <ul style="list-style-type: none"> • connection size: 1/2" IPS • vandal resistant: yes • cartridge type: 1244 • flow type: vandal resistant aerated • mount type: centerpiece • drain assembly: metal • wrist blade handle   	<p>1.2 GPM (4.5 L/min) max.</p> <p>8915</p>	128.40	Chrome	12
	<p>1.2 GPM (4.5 L/min) max.</p> <p>8917</p>	151.35	Chrome	12
 <ul style="list-style-type: none"> • connection size: 1/2" IPS • vandal resistant: yes • cartridge type: 1244 • spout reach: 6.00" • flow type: aerated • mount type: centerpiece • drain assembly not included • removable plug button in lift rod hole • lever handle   	<p>1.2 GPM (4.5 L/min) max.</p> <p>8917</p>	151.35	Chrome	12
	<p>1.2 GPM (4.5 L/min) max.</p> <p>8915</p>	128.40	Chrome	12













COMMERCIAL

M•BITION™ Medium-Duty Kitchen Faucets

		MODEL	LIST	FINISH/CONNECT	CASE QTY
TWO-HANDLE KITCHEN FAUCET					
	<ul style="list-style-type: none"> • connection size: 1/2" IPS • vandal resistant: yes • cartridge type: 1244 • spout reach: 8.50" • flow type: aerated • side spray: yes • drain assembly not included • lever handle 	2.0 GPM (7.6 L/min) max.			
		8792	287.00	Chrome	6
	<ul style="list-style-type: none"> • connection size: 1/2" IPS • vandal resistant: yes • cartridge type: 1244 • spout reach: 9.00" • flow type: aerated • drain assembly not included • lever handle 	1.5 GPM (5.7 L/min) max.			
		8780	125.75	Chrome	6
	<ul style="list-style-type: none"> • connection size: 1/2" IPS • vandal resistant: yes • cartridge type: 1244 • spout reach: 9.00" • flow type: aerated • drain assembly not included • wrist blade handle 	1.5 GPM (5.7 L/min) max.			
		8798	201.55	Chrome	6
	<ul style="list-style-type: none"> • connection size: 1/2" IPS • vandal resistant: yes • cartridge type: 1244 • spout reach: 8.50" • flow type: aerated • drain assembly not included • wrist blade handle 	1.5 GPM (5.7 L/min) max.			
		8799	262.70	Chrome	6

COMMERCIAL

M•BITION™ Medium-Duty Bar/Pantry Faucets

	MODEL	LIST	FINISH/CONNECT	CASE QTY
TWO-HANDLE BAR/PANTRY FAUCET				
 <ul style="list-style-type: none"> • connection size: 1/2" IPS • vandal resistant: yes • cartridge type: 1244 • spout reach: 4.56" • flow type: aerated • mount type: centerset • drain assembly not included • wrist blade handle   	1.2 GPM (4.5 L/min) max.			
	8938	174.15	Chrome	6
 <ul style="list-style-type: none"> • connection size: 1/2" IPS • vandal resistant: yes • cartridge type: 1244 • spout reach: 4.56" • flow type: aerated • mount type: centerset • drain assembly not included • lever handle   	1.2 GPM (4.5 L/min) max.			
	8957	134.15	Chrome	12
 <ul style="list-style-type: none"> • connection size: 1/2" IPS • vandal resistant: yes • cartridge type: 1244 • spout reach: 4.75" • flow type: aerated • mount type: centerset • drain assembly not included • wrist blade handle   	1.2 GPM (4.5 L/min) max.			
	8948	171.80	Chrome	6



















M•POWER™ Below-Deck Sensor-Operated Faucets & Soap Dispensers



Align® Below-Deck Sensor-Operated Modern Faucet / 8559







Align® Below-Deck Sensor-Operated Modern Soap Dispenser / 8560

M•POWER™ Sensor-Operated Faucets

		MODEL	LIST	FINISH/CONNECT	CASE QTY			
ALIGN® BELOW-DECK SENSOR-OPERATED MODERN FAUCET								
 <ul style="list-style-type: none"> • connection size: 3/8" compression • vandal resistant: yes • power source: 4AA included with optional AC* • flow type: vandal resistant multi laminar • mount type: single mount • supply length: 24" • non-mixing: yes • drain assembly not included • material: brass <p>    </p>	<p>Ø 0.5 GPM (1.9 L/min) max.</p> <ul style="list-style-type: none"> 8559 615.25 Chrome 6 8559BN 769.05 Brushed Nickel 6 8559BL 830.60 Matte Black 6 <p>4" DECKPLATE SOLD SEPARATELY</p> <ul style="list-style-type: none"> 182546 36.35 Chrome 12 182546BN 45.45 Brushed Nickel 12 182546BL 50.00 Matte Black 12 <p>8" DECKPLATE SOLD SEPARATELY</p> <ul style="list-style-type: none"> 99558 47.70 Chrome 20 99558BN 59.65 Brushed Nickel 20 99558BL 65.60 Matte Black 20 							
	ALIGN® BELOW-DECK SENSOR-OPERATED MODERN SOAP DISPENSER							
	 <ul style="list-style-type: none"> • easily refillable 1500ml foam soap reservoir included • material: brass <p>   </p>	<ul style="list-style-type: none"> 8560 523.45 Chrome 3 8560BN 654.30 Brushed Nickel 3 8560BL 706.65 Matte Black 3 <p>BRASS SPACER SOLD SEPARATELY</p> <ul style="list-style-type: none"> 181149 69.05 Chrome 12 181149BN 86.30 Brushed Nickel 12 181149BL 93.20 Matte Black 12 						
		BELOW-DECK SENSOR-OPERATED TRANSITIONAL CENTERSET FAUCET						
		 <ul style="list-style-type: none"> • connection size: 3/8" compression • vandal resistant: yes • power source: 4AA included with optional AC* • flow type: vandal resistant laminar • mount type: centerset • supply length: 24" • non-mixing: yes • drain assembly not included • material: brass <p>    </p>	<p>Ø 0.5 GPM (1.9 L/min) max.</p> <ul style="list-style-type: none"> CA8301 623.50 Chrome 3 CA8301BN 779.40 Brushed Nickel 3 CA8301BL 841.75 Matte Black 3 					
			BELOW-DECK SENSOR-OPERATED TRANSITIONAL FAUCET					
			 <ul style="list-style-type: none"> • connection size: 3/8" compression • vandal resistant: yes • power source: 4AA included with optional AC* • flow type: vandal resistant laminar • mount type: singlemount • supply length: 24" • non-mixing: yes • drain assembly not included • material: brass <p>    </p>	<p>Ø 0.5 GPM (1.9 L/min) max.</p> <ul style="list-style-type: none"> CA8302 615.25 Chrome 6 CA8302BN 769.05 Brushed Nickel 6 CA8302BL 830.60 Matte Black 6 <p>4" DECKPLATE SOLD SEPARATELY</p> <ul style="list-style-type: none"> 182546 36.35 Chrome 12 182546BN 45.45 Brushed Nickel 12 182546BL 50.00 Matte Black 12 <p>8" DECKPLATE SOLD SEPARATELY</p> <ul style="list-style-type: none"> 99558 47.70 Chrome 20 99558BN 59.65 Brushed Nickel 20 99558BL 65.60 Matte Black 20 				
	BELOW-DECK SENSOR-OPERATED TRANSITIONAL SOAP DISPENSER							
	 <ul style="list-style-type: none"> • easily refillable 1500ml foam soap reservoir included • material: brass <p>   </p>	<ul style="list-style-type: none"> 8558 523.45 Chrome 3 8558BN 654.30 Brushed Nickel 3 8558BL 706.65 Matte Black 3 <p>BRASS SPACER SOLD SEPARATELY</p> <ul style="list-style-type: none"> 181148 79.80 Chrome 12 181148BN 99.75 Brushed Nickel 12 181148BL 107.75 Matte Black 12 						

*Convert to AC power with the following accessories: for single- or multi-unit AC applications, order one (1) multi-unit transformer (104630) which powers up to (8) units, and one (1) faucet AC connector (182538) per unit.

M•POWER™ Sensor-Operated Faucets

	MODEL	LIST	FINISH/CONNECT	CASE QTY
BELOW-DECK SENSOR-OPERATED GOOSENECK MIXING FAUCET				
 <ul style="list-style-type: none"> • connection size: 3/8" compression • power source: 4AA included with optional AC* • flow type: multi-stream laminar • mount type: singlemount • supply length: 24" • drain assembly not included • material: brass 	Ø 0.5 GPM (1.9 L/min) max.			
	8562	1117.10	Chrome	3
	4" DECKPLATE SOLD SEPARATELY			
	182546	36.35	Chrome	12
8" DECKPLATE SOLD SEPARATELY				
	99558	47.70	Chrome	20
BELOW-DECK SENSOR-OPERATED GOOSENECK FAUCET				
 <ul style="list-style-type: none"> • connection size: 3/8" compression • vandal resistant: yes • power source: 4AA included with optional AC* • flow type: vandal resistant multi laminar • mount type: singlemount • supply length: 24" • non-mixing: yes • drain assembly not included • material: brass 	Ø 0.5 GPM (1.9 L/min) max.			
	CA8303	693.80	Chrome	3
	4" DECKPLATE SOLD SEPARATELY			
	182546	36.35	Chrome	12
8" DECKPLATE SOLD SEPARATELY				
	99558	47.70	Chrome	20
BELOW-DECK SENSOR-OPERATED FAUCET WITHOUT SPOUT				
 <ul style="list-style-type: none"> • connection size: 3/8" compression • vandal resistant: yes • power source: 4AA included with optional AC* • mount type: singlemount • supply length: 24" • non-mixing: yes • drain assembly not included • material: brass • spout not included 	Ø 0.5 GPM (1.9 L/min) max.			
	8565	639.80	Chrome	3
	4" DECKPLATE SOLD SEPARATELY			
	182546	36.35	Chrome	12
8" DECKPLATE SOLD SEPARATELY				
	99558	47.70	Chrome	20
GRID DRAIN WITH OVER-FLOW				
 <ul style="list-style-type: none"> • grid strainer • tail piece • drain body 	123816	60.80	Chrome	12
	123816BN	85.15	Brushed Nickel	12
	123816BL	94.00	Matte Black	12

COMMERCIAL

*Convert to AC power with the following accessories: for single- or multi-unit AC applications, order one (1) multi-unit transformer (104630) which powers up to (8) units, and one (1) faucet AC connector (182538) per unit.

M•POWER™ Above-Deck Sensor-Operated Faucets



M•POWER™ Above-Deck Sensor-Operated Lavatory Faucet / 8551 Series

M•POWER™ Sensor-Operated Faucets

AC ABOVE-DECK SENSOR-OPERATED MODERN FAUCET



- connection size: 3/8" compression
- vandal resistant: yes
- power source: AC power
- flow type: vandal resistant multi laminar
- mount type: single mount
- supply length: 24"
- non-mixing: yes
- drain assembly not included



Ø 0.5 GPM (1.9 L/min) max.

MODEL	LIST	FINISH/CONNECT	CASE QTY
8551AC	663.95	Chrome	6
4" DECKPLATE SOLD SEPARATELY			
99556	37.15	Chrome	20
8" DECKPLATE SOLD SEPARATELY			
99558	47.70	Chrome	20

ABOVE-DECK SENSOR-OPERATED MODERN MIXING FAUCET



- connection size: 3/8" compression
- vandal resistant: yes
- power source: battery powered 4AA included
- flow type: vandal resistant multi laminar
- mount type: single mount
- supply length: 24"
- temperature & manual override: yes
- drain assembly not included
- handle type: lever



Ø 0.5 GPM (1.9 L/min) max.

MODEL	LIST	FINISH/CONNECT	CASE QTY
8552	719.95	Chrome	6
4" DECKPLATE SOLD SEPARATELY			
99556	37.15	Chrome	20
8" DECKPLATE SOLD SEPARATELY			
99558	47.70	Chrome	20

AC ABOVE-DECK SENSOR-OPERATED MODERN MIXING FAUCET



- connection size: 3/8" compression
- vandal resistant: yes
- power source: AC powered
- flow type: vandal resistant multi laminar
- mount type: single mount
- supply length: 24"
- temperature & manual override: yes
- drain assembly not included
- handle type: lever



Ø 0.5 GPM (1.9 L/min) max.

MODEL	LIST	FINISH/CONNECT	CASE QTY
8552AC	719.95	Chrome	6
4" DECKPLATE SOLD SEPARATELY			
99556	37.15	Chrome	20
8" DECKPLATE SOLD SEPARATELY			
99558	47.70	Chrome	20

ABOVE-DECK SENSOR-OPERATED TRANSITIONAL FAUCET



- connection size: 3/8" compression
- vandal resistant: yes
- power source: battery powered 4AA included
- flow type: vandal resistant multi laminar
- mount type: single mount
- supply length: 24"
- non-mixing: yes
- drain assembly not included



Ø 0.5 GPM (1.9 L/min) max.

MODEL	LIST	FINISH/CONNECT	CASE QTY
8553	644.95	Chrome	6
8553BN	806.20	Brushed Nickel	6
8553BL	870.70	Matte Black	6
4" DECKPLATE SOLD SEPARATELY			
99557	37.15	Chrome	20
99557BN	46.45	Brushed Nickel	20
99557BL	51.05	Matte Black	20
8" DECKPLATE SOLD SEPARATELY			
99558	47.70	Chrome	20
99558BN	59.65	Brushed Nickel	20
99558BL	65.60	Matte Black	20

ABOVE-DECK SENSOR-OPERATED MODERN FAUCET



- connection size: 3/8" compression
- vandal resistant: yes
- power source: battery powered 4AA included
- flow type: vandal resistant multi-laminar
- mount type: single mount
- supply length: 24"
- non-mixing: yes
- drain assembly not included



Ø 0.5 GPM (1.9 L/min) max.

MODEL	LIST	FINISH/CONNECT	CASE QTY
8551	644.95	Chrome	6
4" DECKPLATE SOLD SEPARATELY			
99556	37.15	Chrome	20
8" DECKPLATE SOLD SEPARATELY			
99558	47.70	Chrome	20

M•POWER™ Sensor-Operated Faucets

		MODEL	LIST	FINISH/CONNECT	CASE QTY	
AC ABOVE-DECK SENSOR-OPERATED TRANSITIONAL FAUCET						
 <ul style="list-style-type: none"> • connection size: 3/8" compression • vandal resistant: yes • power source: AC powered • flow type: vandal resistant multi laminar • mount type: single mount • supply length: 24" • non-mixing: yes • drain assembly not included 	<ul style="list-style-type: none"> • connection size: 3/8" compression • vandal resistant: yes • power source: battery powered 4AA included • flow type: vandal resistant multi laminar • mount type: single mount • supply length: 24" • temperature & manual override: yes • drain assembly not included • handle type: lever 	<ul style="list-style-type: none"> • connection size: 3/8" compression • vandal resistant: yes • power source: AC power • flow type: vandal resistant multi laminar • mount type: single mount • supply length: 24" • temperature & manual override: yes • drain assembly not included • handle type: lever 	Ø 0.5 GPM (1.9 L/min) max.			
			8553AC	663.95	Chrome	6
			8553ACBN	829.95	Brushed Nickel	6
			8553ACBL	896.35	Matte Black	6
			4" DECKPLATE SOLD SEPARATELY			
			99557	37.15	Chrome	20
			99557BN	46.45	Brushed Nickel	20
			99557BL	51.05	Matte Black	20
			8" DECKPLATE SOLD SEPARATELY			
			99558	47.70	Chrome	20
		99558BN	59.65	Brushed Nickel	20	
		99558BL	65.60	Matte Black	20	
ABOVE-DECK SENSOR-OPERATED TRANSITIONAL MIXING FAUCET						
	Ø 0.5 GPM (1.9 L/min) max.					
			8554	719.95	Chrome	6
			8554BN	899.95	Brushed Nickel	6
			8554BL	971.95	Matte Black	6
			4" DECKPLATE SOLD SEPARATELY			
			99557	37.15	Chrome	20
			99557BN	46.45	Brushed Nickel	20
			99557BL	51.05	Matte Black	20
			8" DECKPLATE SOLD SEPARATELY			
			99558	47.70	Chrome	20
		99558BN	59.65	Brushed Nickel	20	
		99558BL	65.60	Matte Black	20	
AC ABOVE-DECK SENSOR-OPERATED TRANSITIONAL MIXING FAUCET						
	Ø 0.5 GPM (1.9 L/min) max.					
			8554AC	719.95	Chrome	6
			8554ACBN	899.95	Brushed Nickel	6
			8554ACBL	971.95	Matte Black	6
			4" DECKPLATE SOLD SEPARATELY			
			99557	37.15	Chrome	20
			99557BN	46.45	Brushed Nickel	20
			99557BL	51.05	Matte Black	20
			8" DECKPLATE SOLD SEPARATELY			
			99558	47.70	Chrome	20
		99558BN	59.65	Brushed Nickel	20	
		99558BL	65.60	Matte Black	20	
LOW-FLOW THERMOSTATIC MIXING VALVE						
	Ø 0.35 GPM (1.32 L/min) max.					
			104451	180.55	Chrome	12

COMMERCIAL

M•POWER™ Sensor-Operated Faucets**THERMOSTATIC MIXING VALVE SERVICE KITS**

Part No.	Description	List Price	Case Qty
175916	1/2" IPS Adapter Kit	17.05	12
175917	1/2" CC Adapter Kit	17.05	1
175918	1/2" Cold Expansion PEX Adapter Kit	17.05	12
181040	1/2" Crimp Ring PEX Adapter Kit	17.05	12
175921	3/8" Compression Adapter Kit	17.05	12
175925	Fitting Nut Kit	17.05	12
175926	Screen Washer and Seal Washer Kit	17.05	12

See 642 for sensor-operated faucet accessories.

	MODEL	LIST	FINISH/CONNECT	CASE QTY
GRID DRAIN WITH OVER-FLOW				
<ul style="list-style-type: none"> • grid strainer • tail piece • drain body 	123816	60.80	Chrome	12
	123816BN	85.15	Brushed Nickel	12
	123816B L	94.00	Matte Black	12



M•POWER™ Sensor-Operated Faucets

SENSOR-OPERATED FAUCET ACCESSORIES

Part No.	Description	List Price
174055	Battery Housing for Above and Below-Deck Models	34.05
174056	Solenoid Repair Kit for All Above-Deck SKUs 8551, 8552, 8553, 8554, 8551AC, 8552AC, 8553AC, 8554AC	108.15
174057	Strain Relief and Sensor Cable Extension for 8551-8554	30.05
174060	Mounting Hardware for All Above-Deck SKUs 8551, 8552, 8553, 8554, 8551AC, 8552AC, 8553AC, 8554AC	19.05
174061	Manual Temperature Control Handle Kit 8552, 8554, 8552AC, 8554AC	26.70
174061BN	Manual Temperature Control Handle Kit 8554, 8554CBN	33.40
174061BL	Manual Temperature Control Handle Kit 8554, 8554CBL	36.75
174062	T10 Torx Key and Screw for All Above-Deck SKUs 8551, 8552, 8553, 8554, 8551AC, 8552AC, 8553AC, 8554AC	9.85
174065	In-Line Filter with Check Valve for All Above-Deck SKUs 8551, 8552, 8553, 8554, 8551AC, 8552AC, 8553AC, 8554AC	54.00
174066	Filter Screen for Filter Housing for All Above-Deck SKUs 8551, 8552, 8553, 8554, 8551AC, 8552AC, 8553AC, 8554AC	6.25
174335	Sensor and Bracket for 8553, 8554, 8553AC, 8554AC	213.65
174336	Override Plug Button for 8552, 8552AC	21.20
174337	Override Plug Button for 8554, 8554AC	21.20
174337BN	Override Plug Button for 8554BN, 8554CBN	26.50
174337BL	Override Plug Button for 8554BL, 8554CBL	29.15
99556	4" Deckplate designed for 8551, 8551AC, 8552, 8552AC	37.15
99557	4" Deckplate designed for 8553, 8553AC, 8554, 8554AC	37.15
99557BN	4" Deckplate designed for 8553, 8553AC, 8554, 8554AC	46.45
99557BL	4" Deckplate designed for 8553, 8553AC, 8554, 8554AC	51.05
99558	8" Deckplate for 8559, CA8302, 8562, CA8303, 8565, 8551, 8551AC, 8552, 8552AC, 8553, 8553AC, 8554, 8554AC	47.70
99558BN	8" Deckplate for 8559, CA8302, 8562, CA8303, 8565, 8551, 8551AC, 8552, 8552AC, 8553, 8553AC, 8554, 8554AC	59.65
99558BL	8" Deckplate for 8559, CA8302, 8562, CA8303, 8565, 8551, 8551AC, 8552, 8552AC, 8553, 8553AC, 8554, 8554AC	65.60
52016F05	0.5 gpm Multi-Stream Laminar Flow Aerator	20.75
52016F10	1.0 gpm Aerator	20.75
S0030NA	Smooth-End Spout with 1.5 gpm Laminar Flow Base Insert	76.90
104630	Multi-Unit AC Transformer (powers up to 8 units)	109.90
182534	Control Box for Gooseneck and Above-Deck AC Models	55.80
182535	Control Box for CA83021, 8559, CA8302	150.30
182536	Control Box Wall Mounting Hardware	10.65
182537	IR Sensor Assembly and Bracket for Below-Deck Models	165.35
182538	AC Connector	23.40
182540	Cable Harness and Vandal Sleeve for Below-Deck Non-Mixing Models	56.60
182542	Centerset Deck Gasket for CA8301	18.15
182543	Transitional Deck Gasket for CA8302	18.05
182544	Modern Deck Gasket for 8559	18.05
182546	4" Deckplate for 8559, CA8302, 8562, CA8303, 8565	36.35
182546BN	4" Deckplate for 8559, CA8302, 8562, CA8303, 8565	45.45
182546BL	4" Deckplate for 8559, CA8302, 8562, CA8303, 8565	50.00
182547	Override Plug Button	26.25

























SENSOR-OPERATED SOAP DISPENSER ACCESSORIES

Part No.	Description	List Price
182413	Non-Drip Foam Soap Pump	62.00
182414	1500mL Foam Soap Bottle	17.50
182415	Control Box for Sensor Soap	127.85
182416	Mounting Bracket, Vandal Shield and Mounting Hardware for Sensor Soap	105.80
182417	Soap Tube, O-Ring, Spout Barb and Soap Net	52.15
182418	Soap Net	36.40
182419	Vandal Sheathing for Sensor Soap	17.65
182420	Wire Vandal Sheathing for Sensor Soap	46.35
182421	D-Cell Battery Box for Sensor Soap	67.20
182422	Sensor, Bracket and Screw for Sensor Soap	165.35
181148	Transitional Deck Spacer for 8558	79.80
181148BN	Transitional Deck Spacer for 8558	99.75
181148BL	Transitional Deck Spacer for 8558	107.75
181149	Modern Deck Spacer for 8560	69.05
181149BN	Modern Deck Spacer for 8560	86.30
181149BL	Modern Deck Spacer for 8560	93.20

M•POWER™ Sensor-Operated Flush Valves







M•POWER™ Sensor-Operated Flush Valves

		MODEL	LIST	FINISH/CONNECT	CASE QTY	
1-1/2" DC SENSOR-OPERATED CLOSET FLUSH VALVE						
 <ul style="list-style-type: none"> flush valve type: water closet vandal resistant: yes battery-powered (4AA included) flush valve technology: accuset piston cast brass material easy front battery access mechanical override  	<ul style="list-style-type: none"> flush valve type: water closet vandal resistant: yes battery-powered (4AA included) flush valve technology: accuset piston cast brass material easy front battery access mechanical override  					
		3.5 GPF (13.0 LPF)				
		8310S35	636.50	Chrome	3	
		1.6 GPF (6.0 LPF)				
	8310	636.50	Chrome	3		
	1.28 GPF (4.8 LPF)					
	8311	636.50	Chrome	3		
1-1/2" DC SENSOR-OPERATED CLOSET FLUSH VALVE - DUAL FLUSH						
 <ul style="list-style-type: none"> flush valve type: water closet dual flush vandal resistant: yes battery-powered (4AA included) flush valve technology: accuset piston cast brass material easy front battery access mechanical override  	<ul style="list-style-type: none"> flush valve type: water closet dual flush vandal resistant: yes battery-powered (4AA included) flush valve technology: accuset piston cast brass material easy front battery access mechanical override  					
		1.0 GPF (3.8 LPF) and 1.6 GPF (6.0 LPF)				
	8310DF16	668.20	Chrome	3		
1-1/2" AC SENSOR-OPERATED CLOSET FLUSH VALVE						
 <ul style="list-style-type: none"> flush valve type: water closet vandal resistant: yes AC powered required 12V transformer: sold separately flush valve technology: accuset piston cast brass material easy front battery access mechanical override  	<ul style="list-style-type: none"> flush valve type: water closet vandal resistant: yes AC powered required 12V transformer: sold separately flush valve technology: accuset piston cast brass material easy front battery access mechanical override  					
		1.6 GPF (6.0 LPF)				
		8310AC16	636.50	Chrome	3	
	1.28 GPF (4.8 LPF)					
	8311AC12	636.50	Chrome	3		
1-1/2" AC SENSOR-OPERATED CLOSET FLUSH VALVE - DUAL FLUSH						
 <ul style="list-style-type: none"> flush valve type: water closet dual flush vandal resistant: yes AC powered required 12V transformer: sold separately flush valve technology: accuset piston cast brass material easy front battery access mechanical override  	<ul style="list-style-type: none"> flush valve type: water closet dual flush vandal resistant: yes AC powered required 12V transformer: sold separately flush valve technology: accuset piston cast brass material easy front battery access mechanical override  					
		1.0 GPF (3.8 LPF) and 1.6 GPF (6.0 LPF)				
	8310ACDF16	668.20	Chrome	3		
3/4" DC SENSOR-OPERATED URINAL FLUSH VALVE						
 <ul style="list-style-type: none"> flush valve type: urinal vandal resistant: yes battery-powered (4AA included) flush valve technology: accuset piston cast brass material easy front battery access mechanical override  	<ul style="list-style-type: none"> flush valve type: urinal vandal resistant: yes battery-powered (4AA included) flush valve technology: accuset piston cast brass material easy front battery access mechanical override  					
		1.0 GPF (3.8 LPF)				
		8312	636.50	Chrome	3	
		0.5 GPF (1.9 LPF)				
	8315	636.50	Chrome	3		
	0.125 GPF (0.5 LPF)					
	8316	636.50	Chrome	3		

For one (1) or multi-unit AC applications, order one (1) multi-unit transformer (104630) which powers up to eight (8) units.

M•POWER™ Sensor-Operated Flush Valves

		MODEL	LIST	FINISH/CONNECT	CASE QTY
3/4" AC SENSOR-OPERATED URINAL FLUSH VALVE					
 <ul style="list-style-type: none"> • flush valve type: urinal • vandal resistant: yes • AC powered • required 12V transformer: sold separately • flush valve technology: accuset piston • cast brass material • easy front battery access • mechanical override 		1.0 GPF (3.8 LPF)			
		8312AC10	636.50	Chrome	3
		0.5 GPF (1.9 LPF)			
		8315AC05	636.50	Chrome	3
		0.125 GPF (0.5 LPF)			
		8316AC	636.50	Chrome	3
DC SENSOR-OPERATED CLOSET FLUSH VALVE RETROFIT KIT					
 <ul style="list-style-type: none"> • flush valve type: water closet retrofit • vandal resistant: yes • battery-powered (4AA included) • flush valve technology: accuset piston • cast brass material • easy front battery access • mechanical override 		3.5 GPF (13.0 LPF)			
		8310SR35	532.60	Chrome	3
		1.6 GPF (6.0 LPF)			
		8310R16	532.60	Chrome	3
		1.28 GPF (4.8 LPF)			
		8310SR128	532.60	Chrome	3
DC SENSOR-OPERATED CLOSET FLUSH VALVE RETROFIT KIT - DUAL FLUSH					
 <ul style="list-style-type: none"> • flush valve type: water closet retrofit • dual flush • vandal resistant: yes • battery-powered (4AA included) • flush valve technology: accuset piston • cast brass material • easy front battery access • mechanical override 		1.0 GPF (3.8 LPF) and 1.6 GPF (6.0 LPF)			
		8310RDF16	559.15	Chrome	3
DC SENSOR-OPERATED URINAL FLUSH VALVE RETROFIT KIT					
 <ul style="list-style-type: none"> • flush valve type: urinal retrofit • vandal resistant: yes • battery-powered (4AA included) • flush valve technology: accuset piston • cast brass material • easy front battery access • mechanical override 		1.0 GPF (3.8 LPF)			
		8312R10	532.60	Chrome	3
		0.5 GPF (1.9 LPF)			
		8312SR05	532.60	Chrome	3
		0.125 GPF (0.5 LPF)			
		8312SR125	532.60	Chrome	3

For one (1) or multi-unit AC applications, order one (1) multi-unit transformer (104630) which powers up to eight (8) units.

M•POWER™ Sensor-Operated Flush Valves**SENSOR-OPERATED FLUSH VALVE ACCESSORIES**













Part No.	Description	List Price
104585	1 ½" Flush Extension Tube-24"	137.60
104587	Flush Valve Trap Primer	167.70
104588	1" Sweat Kit, Flush Valve	31.55
104589	1" Sweat Kit, Flush Valve 6" Long	50.75
104555	1" Angle Stop Valve Flush Valve	128.35
104556	¾" Angle Stop Valve Flush Valve	128.35
104570	Vacuum Breaker Kit	21.00
104571	Brass Valve Body Nut Flush Valve	28.05
104578	1 ½" Brass Flush Valve Tube	53.60
104579	1 ¼" Brass Flush Tube	58.15
104580	¾" Brass Flush Tube	53.70
104581	1 ½" Top Spud Assembly	37.50
104582	1 ¼" Top Spud Assembly	34.15
104583	¾" Top Spud Assembly	29.40
104584	Urinal Tailpiece (24" x ¾")	87.35
104617	Flush Valve Battery Pack	34.00
104618	Front Shroud 1.6 gpf	80.40
104619	Front Shroud 1.28 gpf	80.40
104620	Front Shroud 3.5 gpf	80.40
104621	Front Shroud 1.0 gpf	80.40
104622	Front Shroud 0.5 gpf	80.40
104623	Front Shroud 1.0/1.6 gpf	80.40
104624	Front Shroud 0.125 gpf	80.40
104625	Rear Shroud DC	37.85
104626	Rear Shroud AC	38.90
104627	Flush Valve Override Assembly	36.20
104628	Piston and Manifold Tool	107.00
104630	Multi-Unit AC Transformer (powers up to 8 units)	109.90
104631	AC Cover Tube and Escutcheon	36.30
104633	Solenoid Manifold and Tool	129.45
104634	Flush Valve Override Cap	25.60

M•DURA™ Heavy-Duty Manual Flush Valves



M•DURA™ Heavy-Duty Manual Urinal Flush Valve / 8312M Series

M•DURA™ Heavy-Duty Manual Flush Valves

		MODEL	LIST	FINISH/CONNECT	CASE QTY
1-1/2" MANUAL CLOSET FLUSH VALVE					
 <ul style="list-style-type: none"> flush valve type: water closet flush valve technology: accuset piston cast brass material  	3.5 GPF (13.0 LPF)				
	8310M35	198.30	Chrome	3	
	1.6 GPF (6.0 LPF)				
	8310M16	198.30	Chrome	3	
	 1.28 GPF (4.8 LPF)				
	8310M128	198.30	Chrome	3	
3/4" MANUAL URINAL FLUSH VALVE					
 <ul style="list-style-type: none"> flush valve type: urinal flush valve technology: accuset piston cast brass material  	1.0 GPF (3.8 LPF)				
	8312M10	198.30	Chrome	3	
	 0.5 GPF (1.9 LPF)				
	8312M05	198.30	Chrome	3	
	 0.125 GPF (0.5 LPF)				
	8312M0125	198.30	Chrome	3	
MANUAL CLOSET FLUSH VALVE RETROFIT KIT					
 <ul style="list-style-type: none"> flush valve type: water closet retrofit flush valve technology: accuset piston cast brass material  	 1.28 GPF (4.8 LPF)				
	8310MR128	159.55	Chrome	6	

M•DURA™ Heavy-Duty Manual Flush Valves

MANUAL FLUSH VALVE ACCESSORIES

Part No.	Description	List Price
104540	M•DURA™ 2 1/4" Extension (standard) Nipple (compatible with Delany angle stops)	42.65
104541	M•DURA™ 1 3/4" Extension Nipple (compatible with Delany angle stops)	37.35
104542	M•DURA™ 2 3/4" Extension Nipple (compatible with Delany angle stops)	51.95
104543	M•DURA™ 3 1/4" Extension Nipple (compatible with Delany angle stops)	57.30
104544	M•DURA™ 3 3/4" Extension Nipple (compatible with Delany angle stops)	63.95
104545	M•DURA™ 4 1/4" Extension Nipple (compatible with Delany angle stops)	70.60
104546	M•DURA™ 2 1/8" Extension (standard) Nipple	37.35
104547	M•DURA™ 2 1/2" Extension Nipple	41.35
104548	M•DURA™ 3" Extension Nipple	44.00
104549	M•DURA™ 3 1/2" Extension Nipple	47.95
104550	M•DURA™ 4" Extension Nipple	53.35
104551	M•DURA™ 4 1/2" Extension Nipple	57.30
104552	M•DURA™ 5" Extension Nipple	63.95
104553	M•DURA™ 5 1/2" Extension Nipple	67.95
104554	M•DURA™ 6" Extension Nipple	73.25
104555	M•DURA™ 1" Angle Stop	128.35
104556	M•DURA™ 3/4" Angle Stop	128.35
104557	M•DURA™ Angle Stop Repair Kit	22.45
104560	M•DURA™ Offset Flush Tube 2 1/2" x 1 1/2"	49.85
104561	M•DURA™ Cap Assembly	70.35
104563	M•DURA™ 3.5 gpf (13.2 lpf) Piston	94.60
104564	M•DURA™ 1.6 gpf (6.0 lpf) Piston	94.60
104565	M•DURA™ 1.28 gpf (4.8 lpf) Piston	94.60
104566	M•DURA™ 1.0 gpf (3.8 lpf) Piston	94.60
104567	M•DURA™ 0.5 gpf (1.9 lpf) Piston	94.60
104568	M•DURA™ 0.125 gpf (0.5 lpf) Piston	94.60
104569	M•DURA™ Handle Assembly	28.45
104570	M•DURA™ Vacuum Breaker Assembly	21.00
104571	M•DURA™ Body Nut	28.05
104572	M•DURA™ Angle Stop Replacement Cap	7.30
104578	M•DURA™ Flush Tube 8 1/2" x 1 1/2"	53.60
104579	M•DURA™ Flush Tube 8" x 1 1/4"	58.15
104580	M•DURA™ Flush Tube 8" x 1 3/4"	53.70
104581	M•DURA™ 1 1/2" Top Spud Assembly	37.50
104582	M•DURA™ 1 1/4" Top Spud Assembly	34.15
104583	M•DURA™ 3/4" Top Spud Assembly	29.40
104584	M•DURA™ Flush Extension Tube 24" x 3/4"	87.35
104585	M•DURA™ Flush Extension Tube 24" x 1 1/2"	137.60
104588	M•DURA™ Sweat Kit (1" supply) 3" length	31.55
104589	M•DURA™ Sweat Kit (1" supply) 6" length	50.75
104590	M•DURA™ Cap Assembly with 3.5 gpf Marking	30.15
104591	M•DURA™ Cap Assembly with 1.6 gpf Marking	30.15
104592	M•DURA™ Cap Assembly with 1.28 gpf Marking	30.15
104593	M•DURA™ Cap Assembly with 1.0 gpf Marking	30.15
104594	M•DURA™ Cap Assembly with 0.5 gpf Marking	30.15
104595	M•DURA™ Cap Assembly with 0.125 gpf Marking	30.15
104597	M•DURA™ Tail Piece and Interior Cap Tool	20.15
104598	M•DURA™ Sweat Kit (3/4" supply) 3" length	29.70
104599	M•DURA™ Sweat Kit (3/4" supply) 6" length	53.35
104609	M•DURA™ Piston Gaskets	11.65

BEDPAN WASHER ACCESSORIES











Part No.	Description	List Price
104573	M•DURA™ Bedpan Washer Seal Kit	27.15
104574	M•DURA™ Bedpan Washer Seal Kit	59.30
104575	M•DURA™ Bedpan Washer Arm Assembly	53.20
104577	M•DURA™ Bedpan Washer Spray Face	12.75
104600	M•DURA™ Offset Flush Tube 8" x 1 1/2"	57.25

M•DURA™ Heavy-Duty Showering



M•DURA™ Modern Heavy-Duty Shower System / T9342 Series

M•DURA™ Heavy-Duty Showering

	MODEL	LIST	FINISH/CONNECT	CASE QTY
POSI-TEMP® PRESSURE-BALANCE TUB/SHOWER WITH HANDSHOWER ON SLIDEBAR				
 <ul style="list-style-type: none"> • connection: 1/2" • single-function standard showerhead • single-function handshower with non-positive pause • non-diverting tub spout length 5" • hose: 72" metal • Posi-Temp® and transfer valve included • cartridge: 1222HD • check stops: yes • valve meets ASSE performance requirements • 30" slide bar included † • drop ell included 	2.5 GPM (9.5 L/min) max.			
	8343	712.90	Chrome	1
POSI-TEMP® PRESSURE-BALANCE TUB/SHOWER TRIM WITH HANDSHOWER ON SLIDEBAR				
 <ul style="list-style-type: none"> • connection: 1/2" • single-function standard showerhead • single-function handshower with non-positive pause • non-diverting tub spout length 5" • hose: 72" metal • Posi-Temp® and transfer valves sold separately • 30" slide bar included † • drop ell included  POWERBOOST	2.5 GPM (9.5 L/min) max.			
	T8343	381.40	Chrome	1
	T8343CBN	560.80	Classic Brushed Nickel	1
 <ul style="list-style-type: none"> • connection: 1/2" • single-function standard showerhead • single-function handshower with non-positive pause • non-diverting tub spout length 5" • hose: 72" metal • Posi-Temp® and transfer valves sold separately • 30" slide bar included † • drop ell included  POWERBOOST	1.5 GPM (5.7 L/min) max.			
	T8343EP15	381.40	Chrome	1
	T8343EP15CBN	560.80	Classic Brushed Nickel	1
POSI-TEMP® MIXING SHOWER VALVE				
 <ul style="list-style-type: none"> • cartridge type: ceramic disc • valve type: transfer • no. of ports: four 	8370HD	139.65	1/2" CC without Integral stops	6
	8371HD	168.05	1/2" CC with Integral stops	6
	8372HD	168.05	1/2" IPS with Integral stops	6
	8373HD	168.05	1/2" PEX with Integral stops	6
	8374HD	181.15	1/2" CPVC with Integral stops	6
	8375HD	168.05	1/2" Cold Exp. PEX w/ Integral Stops	6
THREE-FUNCTION TRANSFER VALVE				
 <ul style="list-style-type: none"> • cartridge type: ceramic disc • valve type: transfer • no. of ports: four • functions: three discrete 	3360	205.55	1/2" CC	6
HOW TO ORDER VALVES: PAGES 664-665				
				

COMMERCIAL















*The brass Posi-Temp® valves meet ASSE 1016 compliance requirements for controlling temperature fluctuations when paired with Moen Commercial showerheads and handshowers with flow rates as low as 1.5 gpm (5.7 lpm).

† Slide bar is not a grab bar. Not to be used as support.

 ADA compliant (excluding holders, slide bars and diverting tub spout)

 BAA compliant  WaterSense®  Water-saving



M•DURA™ Heavy-Duty Showering

	MODEL	LIST	FINISH/CONNECT	CASE QTY
POSI-TEMP® PRESSURE-BALANCE SHOWER ONLY TRIM WITH HANDSHOWER ON SLIDEBAR				
 <ul style="list-style-type: none"> • connection: 1/2" • single-function standard showerhead • single-function handshower with non-positive pause • hose: 72" metal • Posi-Temp® and transfer valves sold separately • 30" slide bar included † • drop ell included • marked with red/blue temperature indicators 	1.5 GPM (5.7 L/min) max. T9342EP15 493.55 Chrome 1			
	POSI-TEMP® MIXING SHOWER VALVE			
 <ul style="list-style-type: none"> • cartridge type: ceramic disc • valve type: transfer • no. of ports: four 	8370HD	139.65	1/2" CC without Integral stops	6
	8371HD	168.05	1/2" CC with Integral stops	6
	8372HD	168.05	1/2" IPS with Integral stops	6
	8373HD	168.05	1/2" PEX with Integral stops	6
	8374HD	181.15	1/2" CPVC with Integral stops	6
	8375HD	168.05	1/2" Cold Exp. PEX w/ Integral Stops	6
THREE-FUNCTION TRANSFER VALVE				
 <ul style="list-style-type: none"> • cartridge type: ceramic disc • valve type: transfer • no. of ports: four • functions: three discrete 	3360	205.55	1/2" CC	6
HOW TO ORDER VALVES: PAGES 664-665				
				
POSI-TEMP® PRESSURE-BALANCE SHOWER ONLY TRIM WITH HANDSHOWER ON SLIDEBAR GRAB BAR				
 <ul style="list-style-type: none"> • connection: 1/2" • single-function standard showerhead • single-function handshower with non-positive pause • hose: 72" metal • Posi-Temp® and transfer valves sold separately • 24" slide bar / grab bar included • drop ell included • marked with red/blue temperature indicators 	1.5 GPM (5.7 L/min) max. T9342GBM15 542.85 Chrome 1			
	POSI-TEMP® MIXING SHOWER VALVE			
 <ul style="list-style-type: none"> • cartridge type: ceramic disc • valve type: transfer • no. of ports: four 	8370HD	139.65	1/2" CC without Integral stops	6
	8371HD	168.05	1/2" CC with Integral stops	6
	8372HD	168.05	1/2" IPS with Integral stops	6
	8373HD	168.05	1/2" PEX with Integral stops	6
	8374HD	181.15	1/2" CPVC with Integral stops	6
	8375HD	168.05	1/2" Cold Exp. PEX w/ Integral Stops	6
THREE-FUNCTION TRANSFER VALVE				
 <ul style="list-style-type: none"> • cartridge type: ceramic disc • valve type: transfer • no. of ports: four • functions: three discrete 	3360	205.55	1/2" CC	6
HOW TO ORDER VALVES: PAGES 664-665				
				

*The brass Posi-Temp® valves meet ASSE 1016 compliance requirements for controlling temperature fluctuations when paired with Moen Commercial showerheads and handshowers with flow rates as low as 1.5 gpm (5.7 lpm).













† Slide bar is not a grab bar. Not to be used as support.

 ADA compliant (excluding holders, slide bars and diverting tub spout)

 BAA compliant  WaterSense®  Water-saving

M•DURA™ Heavy-Duty Showering

MODEL LIST FINISH/CONNECT CASE QTY

POSI-TEMP® PRESSURE-BALANCE SHOWER ONLY WITH HANDSHOWER ON SLIDEBAR						
 <ul style="list-style-type: none"> • connection: 1/2" • single-function standard showerhead • single-function handshower with non-positive pause • hose: 72" metal • Posi-Temp® and transfer valve included • cartridge: 1222HD • check stops: yes • valve meets ASSE performance requirements • 30" slide bar included † • drop ell included 	2.5 GPM (9.5 L/min) max.					
	8342	694.15	Chrome		1	
	1.5 GPM (5.7 L/min) max.					
	8342EP15	694.15	Chrome		1	
POSI-TEMP® PRESSURE-BALANCE SHOWER ONLY TRIM WITH HANDSHOWER ON SLIDEBAR						
 <ul style="list-style-type: none"> • connection: 1/2" • single-function standard showerhead • single-function handshower with non-positive pause • hose: 72" metal • Posi-Temp® and transfer valves sold separately • 30" slide bar included † • drop ell included 	2.5 GPM (9.5 L/min) max.					
	T8342	361.00	Chrome		1	
	T8342CBN	530.65	Classic Brushed Nickel		1	
	1.5 GPM (5.7 L/min) max.					
	T8342EP15	361.00	Chrome		1	
	T8342EP15CBN	530.65	Classic Brushed Nickel		1	
 <ul style="list-style-type: none"> • connection: 1/2" • single-function standard showerhead • single-function handshower with non-positive pause • hose: 72" metal • Posi-Temp® and transfer valves sold separately • 30" slide bar included † • drop ell included 	T8342NH	352.35	Chrome		1	
	T8342NHCBN	483.15	Classic Brushed Nickel		1	
POSI-TEMP® MIXING SHOWER VALVE						
 <ul style="list-style-type: none"> • cartridge type: ceramic disc • valve type: transfer • no. of ports: four 	8370HD	139.65	1/2" CC without Integral stops		6	
	8371HD	168.05	1/2" CC with Integral stops		6	
	8372HD	168.05	1/2" IPS with Integral stops		6	
	8373HD	168.05	1/2" PEX with Integral stops		6	
	8374HD	181.15	1/2" CPVC with Integral stops		6	
	8375HD	168.05	1/2" Cold Exp. PEX w/ Integral Stops		6	
THREE-FUNCTION TRANSFER VALVE						
 <ul style="list-style-type: none"> • cartridge type: ceramic disc • valve type: transfer • no. of ports: four • functions: three discrete 	3360	205.55	1/2" CC		6	
HOW TO ORDER VALVES: PAGES 664-665		 TRIM PART #	+	 VALVE PART #	+	 COMPLETE FAUCET

COMMERCIAL

*The brass Posi-Temp® valves meet ASSE 1016 compliance requirements for controlling temperature fluctuations when paired with Moen Commercial showerheads and handshowers with flow rates as low as 1.5 gpm (5.7 lpm).







† Slide bar is not a grab bar. Not to be used as support.

 ADA compliant (excluding holders, slide bars and diverting tub spout)

 BAA compliant  WaterSense®  Water-saving

M•DURA™ Heavy-Duty Showering

MODEL LIST FINISH/CONNECT CASE QTY

POSI-TEMP® PRESSURE-BALANCE VALVE ONLY TRIM WITH HANDSHOWER ON SLIDE BAR GRAB BAR					
 <ul style="list-style-type: none"> • connection: 1/2" • single-function handshower with non-positive pause • hose: 72" metal • valve sold separately • 24" slide bar / grab bar included • drop ell included • marked with red/blue temperature indicators 	1.5 GPM (5.7 L/min) max.				
	T9346GBM15	478.25	Chrome/Stainless	1	
POSI-TEMP® MIXING SHOWER VALVE					
 <ul style="list-style-type: none"> • cartridge type: ceramic disc • valve type: transfer • no. of ports: four 	8370HD	139.65	1/2" CC without Integral stops	6	
	8371HD	168.05	1/2" CC with Integral stops	6	
	8372HD	168.05	1/2" IPS with Integral stops	6	
	8373HD	168.05	1/2" PEX with Integral stops	6	
	8374HD	181.15	1/2" CPVC with Integral stops	6	
	8375HD	168.05	1/2" Cold Exp. PEX w/ Integral Stops	6	
HOW TO ORDER VALVES: PAGES 664-665	 TRIM PART #	+	 VALVE PART #	=	 COMPLETE FAUCET

POSI-TEMP® PRESSURE-BALANCE VALVE ONLY WITH HANDSHOWER ON SLIDE BAR					
 <ul style="list-style-type: none"> • connection: 1/2" • single-function handshower with non-positive pause • hose: 72" metal • Posi-Temp® valve included • cartridge: 1222HD • check stops: yes • valve meets ASSE performance requirements • 30" slide bar included † • drop ell included 	2.5 GPM (9.5 L/min) max.				
	8346	492.80	Chrome	4	
	1.5 GPM (5.7 L/min) max.				
	8346EP15	492.80	Chrome	4	

COMMERCIAL









*The brass Posi-Temp® valves meet ASSE 1016 compliance requirements for controlling temperature fluctuations when paired with Moen Commercial showerheads and handshowers with flow rates as low as 1.5 gpm (5.7 lpm).

† Slide bar is not a grab bar. Not to be used as support.

 ADA compliant (excluding holders, slide bars and diverting tub spout)

 BAA compliant  WaterSense®  Water-saving

M•DURA™ Heavy-Duty Showering

		MODEL	LIST	FINISH/CONNECT	CASE QTY	
POSI-TEMP® PRESSURE-BALANCE VALVE ONLY TRIM WITH HANDSHOWER ON SLIDE BAR						
 <ul style="list-style-type: none"> • connection: 1/2" • single-function handshower with non-positive pause • hose: 72" metal • Posi-Temp® valve sold separately • 30" slide bar included † • drop ell included  		2.5 GPM (9.5 L/min) max.				
		T8346	333.15	Chrome	4	
		T8346CBN	472.40	Classic Brushed Nickel	4	
		1.5 GPM (5.7 L/min) max.				
		T8346EP15	333.15	Chrome	4	
		T8346EP15CBN	472.40	Classic Brushed Nickel	4	
POSI-TEMP® MIXING SHOWER VALVE						
 <ul style="list-style-type: none"> • cartridge type: ceramic disc • valve type: transfer • no. of ports: four 						
		8370HD	139.65	1/2" CC without Integral stops	6	
		8371HD	168.05	1/2" CC with Integral stops	6	
		8372HD	168.05	1/2" IPS with Integral stops	6	
		8373HD	168.05	1/2" PEX with Integral stops	6	
		8374HD	181.15	1/2" CPVC with Integral stops	6	
	8375HD	168.05	1/2" Cold Exp. PEX w/ Integral Stops	6		
HOW TO ORDER						
VALVES: PAGES 664-665		 TRIM PART #	+	 VALVE PART #	=	 COMPLETE FAUCET











*The brass Posi-Temp® valves meet ASSE 1016 compliance requirements for controlling temperature fluctuations when paired with Moen Commercial showerheads and handshowers with flow rates as low as 1.5 gpm (5.7 lpm).

† Slide bar is not a grab bar. Not to be used as support.

 ADA compliant (excluding holders, slide bars and diverting tub spout)

 BAA compliant  WaterSense®  Water-saving

M•DURA™ Heavy-Duty Showering

		MODEL	LIST	FINISH/CONNECT	CASE QTY
POSI-TEMP® PRESSURE-BALANCE TUB/SHOWER					
 <ul style="list-style-type: none"> • connection: 1/2" • single-function standard showerhead • tub spout length: 5.5" • Posi-Temp® valve included • cartridge: 1222HD • check stops: yes • valve meets ASSE performance requirements 		1.5 GPM (5.7 L/min) max.			
		8389EP15	254.90	Chrome	6
POSI-TEMP® PRESSURE-BALANCE TUB/SHOWER TRIM					
 <ul style="list-style-type: none"> • connection: 1/2" • single-function standard showerhead • tub spout length: 5.5" • Posi-Temp® valve sold separately 		2.5 GPM (9.5 L/min) max.			
		T8389	99.60	Chrome	3
		1.5 GPM (5.7 L/min) max.			
	T8389EP15	99.60	Chrome	3	
	T8389EP15CBN	155.60	Classic Brushed Nickel	3	
 <ul style="list-style-type: none"> • connection: 1/2" • single-function standard showerhead • tub spout length: 5.5" • Posi-Temp® valve sold separately 		1.5 GPM (5.7 L/min) max.			
		T9389EP15	165.70	Chrome	3
POSI-TEMP® MIXING SHOWER VALVE					
 <ul style="list-style-type: none"> • cartridge type: ceramic disc • valve type: transfer • no. of ports: four 		1.5 GPM (5.7 L/min) max.			
		8370HD	139.65	1/2" CC without Integral stops	6
		8371HD	168.05	1/2" CC with Integral stops	6
		8372HD	168.05	1/2" IPS with Integral stops	6
		8373HD	168.05	1/2" PEX with Integral stops	6
		8374HD	181.15	1/2" CPVC with Integral stops	6
	8375HD	168.05	1/2" Cold Exp. PEX w/ Integral Stops	6	
HOW TO ORDER VALVES: PAGES 664-665	 TRIM PART #	+	 VALVE PART #	=	 COMPLETE FAUCET

COMMERCIAL













*The brass Posi-Temp® valves meet ASSE 1016 compliance requirements for controlling temperature fluctuations when paired with Moen Commercial showerheads and handshowers with flow rates as low as 1.5 gpm (5.7 lpm).

† Slide bar is not a grab bar. Not to be used as support.

 ADA compliant (excluding holders, slide bars and diverting tub spout)

 BAA compliant  WaterSense®  Water-saving

M•DURA™ Heavy-Duty Showering

		MODEL	LIST	FINISH/CONNECT	CASE QTY
POSI-TEMP® PRESSURE-BALANCE SHOWER ONLY					
 <ul style="list-style-type: none"> • connection: 1/2" • single-function standard showerhead • Posi-Temp® valve included • cartridge: 1222HD • check stops: yes • valve meets ASSE performance requirements 		2.5 GPM (9.5 L/min) max.			
		8375	223.20	Chrome	12
		1.5 GPM (5.7 L/min) max.			
		8375EP15	223.20	Chrome	12
POSI-TEMP® PRESSURE-BALANCE SHOWER ONLY TRIM					
 <ul style="list-style-type: none"> • connection: 1/2" • single-function standard showerhead • Posi-Temp® valve sold separately 		2.5 GPM (9.5 L/min) max.			
		T8375	65.05	Chrome	3
	1.5 GPM (5.7 L/min) max.				
	T8375EP15	65.05	Chrome	3	
 <ul style="list-style-type: none"> • connection: 1/2" • showerhead sold separately • Posi-Temp® valve sold separately 		T8375NH	46.10	Chrome	3
		T8375NHCBN	77.05	Classic Brushed Nickel	3
 <ul style="list-style-type: none"> • connection: 1/2" • single-function standard showerhead • Posi-Temp® valve sold separately 		1.5 GPM (5.7 L/min) max.			
		T9375EP15	130.25	Chrome	3
POSI-TEMP® MIXING SHOWER VALVE					
 <ul style="list-style-type: none"> • cartridge type: ceramic disc • valve type: transfer • no. of ports: four 		8370HD	139.65	1/2" CC without Integral stops	6
		8371HD	168.05	1/2" CC with Integral stops	6
		8372HD	168.05	1/2" IPS with Integral stops	6
		8373HD	168.05	1/2" PEX with Integral stops	6
		8374HD	181.15	1/2" CPVC with Integral stops	6
		8375HD	168.05	1/2" Cold Exp. PEX w/ Integral Stops	6
HOW TO ORDER VALVES: PAGES 664-665		 TRIM PART # +  VALVE PART # =  COMPLETE FAUCET			

COMMERCIAL















*The brass Posi-Temp® valves meet ASSE 1016 compliance requirements for controlling temperature fluctuations when paired with Moen Commercial showerheads and handshowers with flow rates as low as 1.5 gpm (5.7 lpm).

† Slide bar is not a grab bar. Not to be used as support.

 ADA compliant (excluding holders, slide bars and diverting tub spout)

 BAA compliant  WaterSense®  Water-saving

M•DURA™ Heavy-Duty Showering

		MODEL	LIST	FINISH/CONNECT	CASE QTY
POSI-TEMP® PRESSURE-BALANCE VALVE ONLY					
 <ul style="list-style-type: none"> • connection: 1/2" • Posi-Temp® valve included • cartridge: 1222HD • check stops: yes • valve meets ASSE performance requirements  		8370	198.10	Chrome	12
POSI-TEMP® PRESSURE-BALANCE VALVE ONLY TRIM					
 <ul style="list-style-type: none"> • connection: 1/2" • Posi-Temp® valve sold separately  		T8370	37.65	Chrome	3
		T8370CBN	68.75	Classic Brushed Nickel	3
 <ul style="list-style-type: none"> • connection: 1/2" • Posi-Temp® valve sold separately  		T9370	104.10	Chrome	3
POSI-TEMP® MIXING SHOWER VALVE					
 <ul style="list-style-type: none"> • cartridge type: ceramic disc • valve type: transfer • no. of ports: four 		8370HD	139.65	1/2" CC without Integral stops	6
		8371HD	168.05	1/2" CC with Integral stops	6
		8372HD	168.05	1/2" IPS with Integral stops	6
		8373HD	168.05	1/2" PEX with Integral stops	6
		8374HD	181.15	1/2" CPVC with Integral stops	6
		8375HD	168.05	1/2" Cold Exp. PEX w/ Integral Stops	6
<p>HOW TO ORDER</p> <p>VALVES: PAGES 664-665</p>	 <p>TRIM PART #</p>	+	 <p>VALVE PART #</p>	=	 <p>COMPLETE FAUCET</p>













COMMERCIAL

*The brass Posi-Temp® valves meet ASSE 1016 compliance requirements for controlling temperature fluctuations when paired with Moen Commercial showerheads and handshowers with flow rates as low as 1.5 gpm (5.7 lpm).

 ADA compliant (excluding holders, slide bars and diverting tub spout)

 BAA compliant  WaterSense®  Water-saving

M•DURA™ Heavy-Duty Showering

		MODEL	LIST	FINISH/CONNECT	CASE QTY	
M-CORE® 3-SERIES VALVE ONLY						
 <ul style="list-style-type: none"> • connection: 1/2" • M-CORE® valve included • cartridge: M-CORE pressure balanced with volume and temperature control • check stops: yes • valve meets ASSE performance requirements  		U8350	255.30	Chrome	3	
	M-CORE® 3-SERIES VALVE ONLY TRIM					
 <ul style="list-style-type: none"> • connection: 1/2" • cartridge: M-CORE pressure balanced with volume and temperature control • valve sold separately  		UT8350	189.70	Chrome	3	
		UT8350CBN	243.45	Classic Brushed Nickel	3	
M-CORE® MIXING SHOWER VALVE						
 <ul style="list-style-type: none"> • tub/shower or shower only application • ports: four with adj. temp. limit stops • included: test plug and cross flow plug 		U140CI	71.20	1/2" CC/IPS	6	
	 <ul style="list-style-type: none"> • tub/shower or shower only application • ports: four with adj. temp. limit stops • quarter turn stops: included 		U140CIS	102.45	1/2" CC/IPS	6
HOW TO ORDER VALVES: PAGE 465		 TRIM PART #	+	 VALVE PART #	=	 COMPLETE FAUCET













COMMERCIAL

M•DURA™ Heavy-Duty Showering

		MODEL	LIST	FINISH/CONNECT	CASE QTY
THREE-FUNCTION TRANSFER VALVE TRIM					
	<ul style="list-style-type: none"> • connection: 1/2" • transfer valve included • cartridge type: transfer 	8360	243.70	Chrome	6
THREE-FUNCTION TRANSFER VALVE TRIM					
	<ul style="list-style-type: none"> • connection: 1/2" • transfer valve sold separately 	T8360	48.15	Chrome	3
		T8360CBN	87.95	Classic Brushed Nickel	3
	<ul style="list-style-type: none"> • connection: 1/2" • transfer valve sold separately 	T9360	133.20	Chrome	3
	<ul style="list-style-type: none"> • connection: 1/2" • transfer valve sold separately 	T4192	151.75	Chrome	12
THREE-FUNCTION TRANSFER VALVE					
	<ul style="list-style-type: none"> • cartridge type: ceramic disc • valve type: transfer • no. of ports: four • functions: three discrete 	3360	205.55	1/2" CC	6
HOW TO ORDER VALVES: PAGE 665	 TRIM PART #	+	 VALVE PART #	=	 COMPLETE FAUCET
24" X 1-1/4" SLIDE BAR GRAB BAR WITH HANDSHOWER WITHOUT VALVE					
	<ul style="list-style-type: none"> • connection: 1/2" • single-function handshower • handshower includes: non-positive pause • 72" metal hose • slidebar / grab bar and drop ell included 	2.5 GPM (9.5 L/min) max. 52124GBM25	251.45	Chrome/Stainless	3

COMMERCIAL

M•DURA™ Heavy-Duty Showering

	MODEL	LIST	FINISH/CONNECT	CASE QTY
24" X 1-1/2" SLIDE BAR GRAB BAR WITH HANDSHOWER WITHOUT VALVE				
 <ul style="list-style-type: none"> • connection: 1/2" • single-function eco-performance handshower • handshower includes: non-positive pause • 72" metal hose • slidebar / grab bar and drop ell included 	2.5 GPM (9.5 L/min) max.			
	52224GBM25	257.20	Chrome/Stainless	3
	1.75 GPM (6.65 L/min) max.			
	52224GBM17	257.20	Chrome/Stainless	3
	1.5 GPM (5.7 L/min) max.			
	52224GBM15	257.20	Chrome/Stainless	3
	52224GBM15CBN	527.15	Classic Brushed Nickel	3
24" X 1-1/2" SLIDE BAR GRAB BAR WITH HANDSHOWER WITHOUT VALVE				
 <ul style="list-style-type: none"> • connection: 1/2" • single-function handshower • handshower includes: non-positive pause • 59" plastic hose • slidebar / grab bar and drop ell included 	2.5 GPM (9.5 L/min) max.			
	52224GBP25	223.00	Chrome/Stainless	3
36" X 1-1/2" SLIDE BAR GRAB BAR WITH HANDSHOWER WITHOUT VALVE				
 <ul style="list-style-type: none"> • connection: 1/2" • single-function eco-performance handshower • handshower includes: non-positive pause • 72" metal hose • slidebar / grab bar and drop ell included 	2.5 GPM (9.5 L/min) max.			
	52236GBM25	280.05	Chrome/Stainless	3
	1.75 GPM (6.65 L/min) max.			
	52236GBM17	280.05	Chrome/Stainless	3
	1.5 GPM (5.7 L/min) max.			
	52236GBM15	280.05	Chrome/Stainless	3
	52236GBM15CBN	572.90	Classic Brushed Nickel	3
30" SLIDE BAR WITH HANDSHOWER WITHOUT VALVE				
 <ul style="list-style-type: none"> • connection: 1/2" • single-function handshower • handshower includes: non-positive pause • 72" metal hose • slidebar and drop ell included † 	2.5 GPM (9.5 L/min) max.			
	52710	291.90	Glacier/Chrome	6
	52710CBN	580.95	Classic Brushed Nickel	6
	1.5 GPM (5.7 L/min) max.			
	52710EP15	291.90	Chrome	6
	52710EP15CBN	580.95	Classic Brushed Nickel	6
 <ul style="list-style-type: none"> • connection: 1/2" • three-function eco-performance handshower • handshower includes: non-positive pause • 72" metal hose • slidebar and drop ell included † 	1.75 GPM (6.65 L/min) max.			
	52740EP17	291.30	Chrome	6
HANDSHOWER WITH WALL BRACKET WITHOUT VALVE				
 <ul style="list-style-type: none"> • connection: 1/2" • single-function eco-performance handshower • handshower includes: non-positive pause • 72" metal hose • drop ell included 	1.5 GPM (5.7 L/min) max.			
	52748EP15	212.95	Chrome	6







COMMERCIAL

† Slide bar is not a grab bar. Not to be used as support.

 ADA compliant (excluding holders, slide bars and diverting tub spout)

 BAA compliant  WaterSense®  Water-saving

M•DURA™ Heavy-Duty Showering

		MODEL	LIST	FINISH/CONNECT	CASE QTY
HANDSHOWER					
 <ul style="list-style-type: none"> • 1/2" connection • single-function handshower with non-positive pause • integral double check valve in handshower 		2.5 GPM (9.5 L/min) max.			
		8349	79.90	Chrome	6
		1.75 GPM (6.65 L/min) max.			
		8349EP17	79.90	Chrome	6
		8349EP17CBN	116.35	Classic Brushed Nickel	6
		1.5 GPM (5.7 L/min) max.			
		8349EP15	79.90	Chrome	6
8349EP15CBN	116.35	Classic Brushed Nickel	6		
SHOWER ARM AND FLANGE					
 <ul style="list-style-type: none"> • connection: 1/2" IPS • length 6" • all metal 	A705	56.05	Chrome	12	
	A705CBN	84.05	Classic Brushed Nickel	12	
VANDAL-RESISTANT SHOWERHEAD					
 <ul style="list-style-type: none"> • 1/2" connection • single-function eco-performance showerhead • vandal resistant 	1.5 GPM (5.7 L/min) max.				
	9263EP15	77.05	Chrome	12	
 <ul style="list-style-type: none"> • 1/2" connection • single-function eco-performance showerhead • vandal resistant 	1.5 GPM (5.7 L/min) max.				
	5263EP15	56.35	Chrome	12	
	5263EP15CBN	102.85	Classic Brushed Nickel	12	
	1.75 GPM (6.65 L/min) max.				
5263EP17	56.35	Chrome	12		
5263EP17CBN	102.85	Classic Brushed Nickel	12		
 <ul style="list-style-type: none"> • 1/2" connection • single-function eco-performance showerhead • vandal resistant 	1.5 GPM (5.7 L/min) max.				
	52716EP15	74.20	Chrome	20	
VANDAL-RESISTANT WALL-MOUNTED SHOWERHEAD					
 <ul style="list-style-type: none"> • 1/2" connection • single-function eco-performance showerhead • vandal resistant • wallmounted 	2.5 GPM (9.5 L/min) max.				
	8290	126.35	Chrome	12	
 <ul style="list-style-type: none"> • 1/2" connection • single-function eco-performance showerhead • vandal resistant • wallmounted 	1.5 GPM (5.7 L/min) max.				
	8290EP15	121.45	Chrome	12	
 <ul style="list-style-type: none"> • 1/2" connection • single-function eco-performance showerhead • vandal resistant • wallmounted • pivoting nozzle 	2.5 GPM (9.5 L/min) max.				
	8292	131.90	Chrome	12	

COMMERCIAL

 ADA compliant (excluding holders, slide bars and diverting tub spout)

 BAA compliant  WaterSense®  Water-saving

M•DURA™ Heavy-Duty Showering











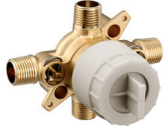

TUB/SHOWERACCESSORIES			
Part No.	Finish	Description	List Price
15856	Chrome	Diverter tub spout, 1/2" slip fit, vandal-resistant	63.60
15856CBN	Classic Brushed Nickel	Diverter tub spout, 1/2" slip fit, vandal-resistant	92.60
100686	Chrome	Slide bar swivel bracket for handshower	53.05
100686CBN	Classic Brushed Nickel	Slide bar swivel bracket for handshower	76.25
104414	Chrome	Wall-mounted bracket for handshower	57.30
52711	---	Slide bar/Grab bar bracket - 1-1/2" diameter	52.90
52714	---	Slide bar/Grab bar bracket - 1-1/4" diameter	52.90
SMA1000CH**	Chrome	SecureMount™ anchors, 1 pair, for use with bedpan washer wallmount flange and grab bars	39.35
A725	Chrome	Drop ell	63.70
A725CBN	Classic Brushed Nickel	Drop ell	86.85
A726	Chrome	69" metal hose (vacuum breaker sold separately)	125.45
A723	Chrome	59" plastic hose (vacuum breaker sold separately)	32.65
A780	Chrome	80" metal hose (vacuum breaker sold separately)	148.00
52703	Chrome	Optional vacuum breaker for handshower, 1/2" IPS connections	70.55

**Moen Accessories part numbers are included for reference purposes only. Moen Accessories CANNOT be combined with Moen faucet parts on a purchase order.





 ADA compliant (excluding holders, slide bars and diverting tub spout)

 BAA compliant  WaterSense®  Water-saving

M•DURA™ Heavy-Duty Tub/Shower Valves

		MODEL	LIST	FINISH/CONNECT	CASE QTY
M•CORE™ CARTRIDGE					
	<ul style="list-style-type: none"> • Single-handle replacement cartridge M-CORE® 3-Series • pressure balanced cartridge with volume and temperature control • includes temperature limit stops 	1213	110.00	N/A or Unfinished	12
BRASS POSI-TEMP® CARTRIDGE					
	<ul style="list-style-type: none"> • graphite composite pressure-balancing spool design • material: brass 	1222HD	107.15	N/A or Unfinished	18
M-CORE® MIXING SHOWER VALVE WITH STOPSV					
	<ul style="list-style-type: none"> • ports: four • adjustable temp. limit stops included • quarter turn stops included • test plug included 	U140CIS	102.45	N/A or Unfinished	6
		U140X	102.45	N/A or Unfinished	6
		U140CXS	102.45	N/A or Unfinished	6
		U140VS	118.50	N/A or Unfinished	6
M-CORE® MIXING SHOWER VALVE					
	<ul style="list-style-type: none"> • ports: four • adjustable temp. limit stops included • cross flow plug: included • test plug included 	U140CI	71.20	N/A or Unfinished	6
		U140X	71.20	N/A or Unfinished	6
		U140CX	71.20	N/A or Unfinished	6
		U140V	87.20	N/A or Unfinished	6
BRASS POSI-TEMP® ROUGH-IN VALVE					
	<ul style="list-style-type: none"> • ports: four • cartridge: 1222HD • valve type: pressure balancing cycling valve 	8370HD	139.65	1/2" CC	6
BRASS POSI-TEMP® ROUGH-IN VALVE					
	<ul style="list-style-type: none"> • ports: four • cartridge: 1222HD • valve type: pressure balancing cycling valve • stops included 	8371HD	168.05	1/2" CC	6

M•DURA™ Heavy-Duty Tub/Shower Valves

		MODEL	LIST	FINISH/CONNECT	CASE QTY
BRASS POSI-TEMP® ROUGH-IN VALVE					
	<ul style="list-style-type: none"> • ports: four • cartridge: 1222HD • pressure balancing cycling valve • stops included 	8372HD	168.05	1/2" IPS	6
BRASS POSI-TEMP® ROUGH-IN VALVE					
	<ul style="list-style-type: none"> • ports: four • cartridge: 1222HD • pressure balancing cycling valve • stops included 	8373HD	168.05	1/2" crimp ring PEX	6
BRASS POSI-TEMP® ROUGH-IN VALVE					
	<ul style="list-style-type: none"> • ports: four • cartridge: 1222HD • pressure balancing cycling valve • stops included 	8374HD	181.15	1/2" CPVC	6
BRASS POSI-TEMP® ROUGH-IN VALVE					
	<ul style="list-style-type: none"> • ports: four • cartridge: 1222HD • pressure balancing cycling valve • stops included 	8375HD	168.05	1/2" cold expansion PEX	6
THREE-FUNCTION TRANSFER VALVE					
	<ul style="list-style-type: none"> • ports: four • cartridge: ceramic disc • valve type: transfer • no. of functions: three discrete functions 	3360	205.55	1/2" CC	6

*The brass Posi-Temp® valves meet ASSE 1016 compliance requirements for controlling temperature fluctuations when paired with Moen Commercial showerheads and handshowers with flow rates as low as 1.5 gpm (5.7 lpm).

M•DURA™ Heavy-Duty Tub/Shower Valves

	MODEL	LIST	FINISH/CONNECT	CASE QTY
HIGH-FLOW THERMOSTATIC MIXING VALVE				
 <ul style="list-style-type: none"> • description: high flow thermostatic mixing valve for roman tubs • ports: three • ASSE standard 1070: yes • flow rate: 12.0 gpm (45.4 L/min) max. 	104465	180.55	1/2" CC	12
	104466	180.55	1/2" IPS	12
	104464	180.55	1/2" Crimp Ring PEX	12
	104463	180.55	1/2" Cold Expansion PEX	12

THERMOSTATIC MIXING VALVE SERVICE KITS

Part No.	Finish	Description	List Price	Case Qty
175916	N/A or Unfinished	1/2" IPS Adapter Kit	17.05	12
175917	N/A or Unfinished	1/2" CC Adapter Kit	17.05	1
175918	N/A or Unfinished	1/2" Cold Expansion PEX Adapter Kit	17.05	12
181040	N/A or Unfinished	1/2" Crimp Ring PEX Adapter Kit	17.05	12
175921	N/A or Unfinished	3/8" Compression Adapter Kit	17.05	12
175925	N/A or Unfinished	Fitting Nut Kit	17.05	12

Model No.	UPC Code	Product Description	Case Qty	List Price
12523	N/A or Unfinished	BSHG STEM SUPPORT WRIST BLADE HANDLE BAG	026508053959	2.75
14690	N/A or Unfinished	CRTRGE SANI CERAMIC DISC HEAVY COMM	026508025550	60.00
14695	N/A or Unfinished	CRTRGE SANI CERAMIC DISC EXTD HEAVY COMM	026508025567	60.00
14834	Chrome	HDL SANI WBH H CHR 1	026508035870	65.35
14838	Chrome	HDL SANI WBH C CHR 1	026508035863	65.35
15440	N/A or Unfinished	VPB W/THERMO VALVE	026508245699	439.60
16000	Chrome	HDL KNB METERING 1H/2H CHR	026508167038	72.20
16264	Chrome	SPT SANI 2H H-FL KD&BAR CHR	026508036129	130.60
16350	Chrome	FRA SANI MALE THRD 0.5 GPM SLOWCLOSE CHR	026508036662	20.15
16352	N/A or Unfinished	SANI SLOWCLOSE CRTRDGE LAV	026508044896	117.80
16360	Chrome	AERATOR KEY CHR	026508228944	5.70
52000	N/A or Unfinished	CER DISC CART, HOT	026508160503	17.35
52001	N/A or Unfinished	CER DISC CART -COLD	026508160510	17.35
52002	N/A or Unfinished	CART NUT KIT MCP	026508160527	24.10
52003	Chrome	WIDESPREAD ESC.	026508160534	40.05
52005	N/A or Unfinished	TORX WRENCH	026508160541	5.30
52006	Chrome	VANDAL RES AERATOR	026508160558	12.00
52008	Chrome	LVR HDNL COLD	026508160572	26.70
52009	Chrome	LVR HDLE HOT	026508160589	26.70
52010	Chrome	COMMERCIAL HDL SERVICE KIT CHR	026508165041	53.35
52011	Chrome	COMMERCIAL HDL SERVICE KIT CHR	026508165058	53.35
52012	N/A or Unfinished	VACUUM BREAKER SERVICE KIT	026508182451	18.70
52015	Chrome	LEVER HANDLE KIT	026508212554	49.35
52019	Chrome	WALLMOUNT CONNECTION FOR 8124 (1PER BOX)	026508212561	70.60
52020	Chrome	WALLMOUNT CONNECTION FOR 8230 (1 PER BOX)	026508212578	70.60
52021	Chrome	HD WIDESPREAD SPOUT KIT	026508212585	122.60
52022	N/A or Unfinished	SET SCREW FOR WIDESPREAD SPOUT	026508212592	2.05
52023	N/A or Unfinished	WIDESPREAD MOUNTING KIT	026508212608	36.00
52024	N/A or Unfinished	SET SCREW METERING	026508212615	2.05
52025	N/A or Unfinished	FRICTION WASHER SERIES SPTS (2 PER BAG)	026508212622	3.40
52028	Chrome	CENTER SPOUT HUB	026508228340	66.55
52035	Chrome	LEVER HANDLE (HOT/COLD) CHR	026508229576	26.70
52110	Chrome	METERING HANDLE	026508207642	72.20
52122	Chrome	METERING ESCUT W/COLOR RINGS	026508207215	55.70
52125	N/A or Unfinished	METERING, CARTRIDGE NUT	026508207222	27.95
52600	Chrome	FRA SANI MALE THRD 0.5 GPM ROSETTA CHR	026508026205	18.70
52601	Chrome	FRA SANI FEMALE THRD 0.5 GPM ROSETTA CHR	026508026229	18.70
52602	Chrome	FRA SANI MALE THRD 0.5 GPM VP CHR	026508026250	20.15
52603	Chrome	FRA SANI FEMALE THRD 0.5 GPM VP CHR	026508026281	20.15
52608	Chrome	FRA SANI MALE THRD 1.5 GPM LAMINAR CHR	026508030394	18.70
52609	Chrome	FRA SANI FEMALE THRD 1.5 GPM LAMINAR CHR	026508026502	18.70
52610	Chrome	FRA SANI MALE THRD 1.5 GPM VP CHR	026508030400	20.15
52611	Chrome	FRA SANI FEMALE THRD 1.5 GPM VP CHR	026508035856	20.15
52612	Chrome	FRA SANI MALE THRD 2.0 GPM LAMINAR CHR	026508035894	18.70
52613	Chrome	FRA SANI FEMALE THRD 2.0 GPM LAMINAR CHR	026508035900	18.70
52614	Chrome	FRA SANI MALE THRD 2.0 GPM VP CHR	026508027851	20.15
52615	Chrome	FRA SANI FEMALE THRD 2.0 GPM VP CHR	026508027868	20.15
52618	Chrome	AERATOR MALE THRD .35 GPM VP CHR	026508035917	15.00
52620	Chrome	M-DURA SERRATED LABORATORY HOSE NOZZLE	026508035979	29.40
54036	N/A or Unfinished	HOT/COLD INDICATORS	026508241462	12.30
59001	Chrome	MODERN 1H MDURA HANDLE KIT	026508012376	41.40
59002	N/A or Unfinished	MDURA 1H CARTRIDGE & RETAINING NUT	026508012383	33.95
59003	N/A or Unfinished	MDURA ATLS & O-RING	026508012390	16.90
59004	Chrome	MODERN 1H MDURA DOME	026508012406	27.00
59005	N/A or Unfinished	MDURA CACHE PCA JR VR AERATOR KEY	026508261613	4.90
59006	Chrome	MDURA WASTE ASSEMBLY WITH LIFT ROD CHR	026508012413	69.90
59007	N/A or Unfinished	MOD 1H MDURA MOUNTING KIT	026508007457	27.45
59008	Chrome	MOD WS MDURA HANDLE KIT	026508261491	42.55
59009	N/A or Unfinished	MOD WS MDURA RED/BLUE RINGS	026508261620	6.85
59010	Chrome	MOD WS MDURA HANDLE HUB KIT	026508261507	82.40
59011	N/A or Unfinished	WS MDURA MOUNTING KIT	026508261514	28.70
59012	Chrome	MOD WS MDURA DIVERTING SPOUT 0.5GPM	026508261637	194.40
59013	Chrome	MOD WS MDURA DIVERTING SPOUT 1.5GPM	026508261644	194.40
59014	Chrome	MOD WS MDURA NONDIVERTING SPOUT 0.5GPM	026508261651	195.75
59015	Chrome	MOD WS MDURA NONDIVERTING SPOUT 1.5GPM	026508261668	195.75
59016	Chrome	MOD MDURA SHOWER POSI ESCUTCHEON	026508261521	34.85
59017	Chrome	MOD MDURA SHOWER POSI HANDLE KIT	026508261538	53.30
59018	Chrome	MOD MDURA SHOWER 3F ESCUTCHEON	026508261675	59.15
59019	Chrome	MOD MDURA SHOWER 3F HANDLE KIT	026508261682	67.20
59021	Chrome	MOD MDURA DIVERTING TUB SPOUT	026508261545	101.45
59022	Chrome	MOD MDURA NONDIVERTING TUB SPOUT	026508261699	93.70
59023	N/A or Unfinished	MOD MDURA TUB SPOUT GATE KIT	026508261705	18.40
59024	Chrome	MDURA WS WASTE ASSY MOD LIFT ROD CHR	026508261552	87.65
59025	N/A or Unfinished	WS MDURA MOUNTING KIT (LIFT ROD VERSION)	026508261569	53.50

Model No.	Finish	Product Description	UPC Code	List Price
59027	Chrome	MODERN 1H M-BITION HANDLE KIT	026508264737	42.25
59029	Chrome	3/32 SET SCREW WITH ALLEN WRENCH	026508264744	6.10
59030	N/A or Unfinished	MODERN 1H LAV VALVE BODY O-RING	026508264751	6.10
59031	Chrome	M-BITION WASTE ASSEMBLY	026508264768	48.30
59033	Chrome	WS M-BITION LIFT ROD	026508264775	17.50
59034	Chrome	WS M-BITION SPOUT 1.2 GPM WITH LIFT ROD	026508264782	168.90
59035	Chrome	3S M-BITION SPOUT 1.2 GPM W/O LIFT ROD	026508264799	166.60
59036	Chrome	WS M-BITION HANDLE TRIM KIT	026508264805	81.55
59037	Chrome	WS M-BITION HANDLE SET SCREW/PLUGBUTTON	026508264812	5.30
92191	Chrome	1DL SANI DLX BLD CHR 2	026508032923	59.95
93379	Chrome	HDL CVR SANI KD/LAV 1H LR CHR	026508040089	21.00
93455	Chrome	ESCT SCRW SANI TS CHR (2)	026508040119	12.00
99457	Chrome	ESCT SANI 1H LAV SGLMT CHR	026508049754	31.35
100040	N/A or Unfinished	CRTRDGE 3 FNCT SRVC KIT	026508087527	125.05
100078	N/A or Unfinished	HDW MTG COMM XFER 3F	026508096284	23.35
100079	Chrome	HDL COMM XFER 3F CHR	026508096291	39.40
100080	N/A or Unfinished	SLV COMM XFER 3F CHR	026508096307	54.70
100087	N/A or Unfinished	COMM XFER 3F	026508096321	8.75
101867	N/A or Unfinished	PIVOT RETAIN &TEMP LIMIT STOP	026508068373	14.40
104020	Chrome	MANUAL TEMP HANDLE 8305 SERIES	026508189337	26.05
104021	Chrome	SOLENOID VLV REPAIR KIT 8302 - 04	026508189344	57.70
104334	N/A or Unfinished	CONTROL MODULE 8310 (CLOSET)	026508155479	186.55
104400	Chrome	ELEC. FAUCET IN-LINE FILTER W/CHECK VALV	026508167670	63.35
104401	N/A or Unfinished	ACC SANI AC POWER ADPT MULTI UNIT	026508108192	106.35
104402	N/A or Unfinished	I CABLE 24 POWER LEAD	026508108208	33.65
104403	N/A or Unfinished	CONTROL MODULE 8312, 8314 (URINAL)	026508155486	186.55
104404	N/A or Unfinished	CONTROL MODULE 8305, 8307 (DC)	026508155493	199.75
104405	N/A or Unfinished	CONTROL MODULE 8306 (AC)	026508155509	199.75
104406	N/A or Unfinished	AC ADAPTER FOR FLUSH VALVES	026508182444	35.80
104424	N/A or Unfinished	SANI MIXING VLV W/INTEGRAL CHECK	026508084229	65.80
104425	N/A or Unfinished	SANI MIXING TEE W/INTEGRAL CHECK	026508084212	25.70
104426	Chrome	GSKT DECK SANI BAR/LAV ELEC SGLMT	026508084205	37.35
104427	N/A or Unfinished	ACC SANI AC POWER ADPT SGL UNIT	026508084199	72.05
104429	Chrome	SPT 5.75" SANI BAR ELEC GOOSENECK CHR	026508084588	47.55
104430	Chrome	SPT 5.38" SANI BAR ELEC GOOSENECK CHR	026508084595	63.60
104431	Chrome	SPT 6 SANI BER ELEC SWING CHR	026508084601	50.30
104432	Chrome	SPT 8 SANI BER ELEC SWING CHR	026508084618	51.55
104433	Chrome	SPT 8.38" SANI BAR ELEC GOOSENECK CHR	026508084625	96.85
104434	Chrome	PC BOARD LAV/BAR	026508084632	318.95
104435	N/A or Unfinished	FLUSH VLV SOLENOID RPR KIT 8310, 8312, 8	026508155523	159.85
104437	N/A or Unfinished	FLUSH VLV CONTROL DISC VLV 8310,8312,831	026508155530	46.70
104438	Chrome	FLTR SCREEN LAV/BAR	026508084656	9.75
104439	Chrome	HDW SOLENOID/HOUSING	026508084663	349.60
104440	N/A or Unfinished	FLUSH VLV BATTERY HLDR 8310,8312,8314	026508155547	7.40
104441	N/A or Unfinished	ELEC. FAUCET IN-LINE FILTER WASHER	026508167663	2.75
104443	Chrome	HDW SUPPLY ROD WLMT	026508084687	18.70
104444	N/A or Unfinished	SPPLY LINE 8305, 8306,8307	026508081914	34.70
104446	N/A or Unfinished	PLUG IN POWER ADPTR (W/CABLE) 8306	026508155554	68.65
104447	N/A or Unfinished	HEX KEY WRENCH 8305, 8306, 8307	026508155561	3.40
104449	Chrome	VP SCREWS & O-RINGS FOR FLUSH VALVES	026508157725	42.05
104450	Chrome	SOLENOID COIL KIT E-FAUCETS 8305-8307	026508157732	145.30
104452	N/A or Unfinished	CONTROL MODULE 8310 (CLOSET 1.28)	026508200629	186.55
104453	Chrome	AC TUBE AND FLANGE FOR FLUSH VALVE	026508200636	66.55
104454	Chrome	AC FLUSH VALVE CAP	026508200643	107.95
104455	Chrome	DC FLUSH VALVE CAP	026508200650	94.60
104456	N/A or Unfinished	SENSOR EYE CASING	026508200667	14.65
104458	N/A or Unfinished	SPLIT WASHER FOR ELECTRONIC SPOUT	026508200681	2.90
104459	N/A or Unfinished	BATTERY HOLDER FOR ELECTRONIC FAUCET	026508200698	7.40
104461	Chrome	MANUAL OVERRIDE BUTTON	026508200728	35.05
104500	Chrome	2-1/4" DELANY (STANDARD) NIPPLE	026508176634	42.65
104501	Chrome	1-3/4" DELANY NIPPLE	026508176641	37.35
104502	Chrome	2-3/4" DELANY NIPPLE	026508176658	51.95
104503	Chrome	3-1/4" DELANY NIPPLE	026508176665	57.30
104504	Chrome	3-3/4" DELANY NIPPLE	026508176672	63.95
104505	Chrome	4-1/4" DELANEY NIPPLE	026508176689	70.60
104506	Chrome	2-1/8" SLOAN (STANDARD) NIPPLE	026508176696	37.35
104507	Chrome	2-1/2" SLOAN NIPPLE	026508176702	41.35
104508	Chrome	3" SLOAN NIPPLE	026508176719	44.00
104509	Chrome	3-1/2" SLOAN NIPPLE	026508176726	47.95
104510	Chrome	4" SLOAN NIPPLE	026508176733	53.35
104511	Chrome	4-1/2" SLOAN NIPPLE	026508176740	57.30
104512	Chrome	5" SLOAN NIPPLE	026508176757	63.95
104513	Chrome	5-1/2" SLOAN NIPPLE	026508176764	67.95
104514	Chrome	6" SLOAN NIPPLE	026508176771	73.25

Model No.	Finish	Product Description	UPC Code	List Price
104520	N/A or Unfinished	SENSOR EYE FOR FLUSH VALVE	026508189191	89.30
104523	Chrome	ANGLE STOP REPAIR KIT	026508189221	22.45
104524	Chrome	MANUAL OVERRIDE BUTTON	026508189238	42.05
104527	N/A or Unfinished	O RING FOR FLUSH VALVE SEAT	026508189269	6.40
104534	Chrome	1.5 GPM AERATOR FOR 83-5 SERIES	026508200711	20.75
104536	Chrome	PLASTIC FLUSH VALVE CAP MOUNT (1 CAP PER	026508213179	21.30
104537	N/A or Unfinished	PISTON TIP ASSEMBLY SERVICE KIT (10 TIPS	026508213186	40.05
104539	Chrome	SECURITY SET SCREW E-FAUCETS	026508213209	5.40
104770	Chrome	MCP METAL DRAIN ROUND KNOB	026508210123	23.70
104775	Chrome	MCP METAL DRAIN FLUTTED	026508210130	26.05
106321	N/A or Unfinished	HDL EXT 1.000 5F XFER VLV CHR	026508085158	115.65
109146	N/A or Unfinished	SANI CABLE/SENSOR EYE 6"	026508102398	248.40
116715	Chrome	SPT ASSY 8948 BAR	026508133453	38.65
121520	Chrome	HDL LR W/SCW HD CMP CHR	026508134757	25.25
121521	Chrome	HDL LR W/SCW HD CMP CHR	026508134740	22.45
121549	N/A or Unfinished	CRTRGE 1H 40MM HD CMP	026508134719	26.05
121550	N/A or Unfinished	CRTRGE 2H HOT 28MM HD CMP	026508134726	14.55
121551	N/A or Unfinished	CRTRGE 2H COLD HD 28MM CMP	026508134733	14.55
121620	N/A or Unfinished	CRTRGE 1H 40MM HD CMP	026508136683	26.05
129900	Chrome	LEVER HANDLE 6" CHROME KIT	026508165072	37.35
129902	Brushed Nickel	LEVER HANDLE 6" BRUSHED NICKEL	026508165096	33.35
140860	N/A or Unfinished	DECK GASKET FOR 8210-8219 SERIES, 8886	026508253274	17.85
162649	N/A or Unfinished	EXTENSION SERVICE KIT	026508234594	118.60
163127	N/A or Unfinished	CARTRIDGE KIT	026508234563	125.05
163128	Chrome	ESCUTCHEON, CHR	026508234570	77.95
163215	N/A or Unfinished	C-CLIP FOR FIXED SPOUT	026508255360	11.85
176415	Chrome	VACUUM BREAKER KIT FOR 8124 AND 8232	026508276037	27.95
176787	N/A or Unfinished	RECTANGULAR BRACKET- COMMERCIAL KITCHEN	026508276044	16.05
183073	N/A or Unfinished	CAGE SPACER KIT FOR 8138	026508271513	14.20
183082	N/A or Unfinished	MOUNTING HARDWARE KIT FOR 8138	026508271520	26.25
183085	Chrome	FRA SANI FEMALE THRD 1.2 GPM VP CHR	-	20.15
187104	N/A or Unfinished	MOD SENSOR/BACKET 8551 (AC), 8552 (AC)	026508277911	213.65
191187	N/A or Unfinished	8894 MOUNTING HARDWARE	026508291207	13.05
840011	Chrome	3" HANDLE M-BITION 1H LAV CHR	026508237076	98.60
840012	Chrome	4" HANDLE M-BITION 1H LAV CHR	026508237083	98.60
840013	N/A or Unfinished	NUT, ADJ TEMP LIMIT STOP CART BRS	026508239568	24.05
840014	N/A or Unfinished	NUT, ADJ TEMP LIMIT STOP CART BRS	026508239575	50.35
870112	Chrome	SINGLE-MOUNT ESCUTCHEON CHR	026508244142	15.85
870113	Chrome	DECK PLATE	026508244067	53.05
870114	Chrome	9" SPOUT ASSEMBLY KIT CHR	026508244159	136.40
870115	Chrome	12" SPOUT ASSEMBLY KIT CHR	026508244166	140.40
870116	Chrome	HARDWARE PACKAGE	026508246375	154.65
870121	Chrome	SPOUT ASSEMBLY KIT CHR	026508271278	124.20
881111	Chrome	HANDLE KIT, 8894	026508235201	26.70
881121	Chrome	WS METERING SPOUT KIT, CHR	026508235249	122.60
100078CBN	Brushed Nickel	HDW MTG COMM XFER 3F	026508244821	12.00
100079CBN	Brushed Nickel	HDL COMM XFER 3F CBN	026508239797	57.25
100080CBN	Brushed Nickel	SLV COMM XFER 3F CBN	026508244760	79.65
14834CBN	Classic Brushed Nickel	HDL SANI WBH H CBN 1	026508239827	95.15
14838CBN	Classic Brushed Nickel	HDL SANI WBH C CBN 1	026508239834	95.15
150628CBN	Classic Brushed Nickel	HANDLE DOME CBN	026508239841	11.85
163128CBN	Classic Brushed Nickel	ESCUTCHEON, CBN	026508239865	116.95
52016F03	Chrome	AERATOR .35GPM VAND-RESISTANT CHR	026508236277	20.75
52016F12	Chrome	AERATOR 1.2GPM VAND-RESISTANT CHR	026508269619	11.25
52016F15	Chrome	AERATOR 1.5GPM VAND-RESISTANT CHR	026508236291	20.75
52016F22	Chrome	AERATOR 2.2GPM VAND-RESISTANT CHR	026508236307	20.75
52016SLC05	N/A or Unfinished	CACHE 0.5 GPM SLC VR AERATOR	026508274293	20.75
52016SLC12	N/A or Unfinished	CACHE 1.2 GPM SLC VR AERATOR	026508269121	20.75
52016SLC22	N/A or Unfinished	CACHE 2.2 GPM SLC VR AERATOR	026508274309	20.75
52018F12	N/A or Unfinished	1.2GPM CACHE VANDAL-RESISTANT LAMINAR	026508270288	20.75
52018F22	N/A or Unfinished	AERATOR 2.2GPM LAMINAR VAND-RESIST	026508232934	11.85
840011CBN	Classic Brushed Nickel	3" HANDLE M-BITION 1H LAV CBN	026508243299	147.95
840015F03	N/A or Unfinished	AERATOR .35GPM RECESSED VAND-RESISTANT	026508236338	15.00
840015F12	N/A or Unfinished	AERATOR 1.2GPM RECESSED VAND-RESISTANT	026508269640	33.10
840015F15	N/A or Unfinished	AERATOR 1.5GPM RECESSED VAND-RESISTANT	026508236369	15.00
840015F22	N/A or Unfinished	AERATOR 2.2GPM RECESSED VAND-RESISTANT	026508236352	15.00
93455CBN	Classic Brushed Nickel	ESCUTCHEON SCREWS, CBN	026508244722	13.95

Model No.	UPC	Page Number	Case Qty.	List Price
1222HD	026508207604	541	18	107.15
3360	026508222768	651	6	205.55
5263EP15	026508237236	662	12	56.35
5263EP15CBN	026508237243	662	12	102.85
5263EP17	026508237250	662	12	56.35
5263EP17CBN	026508237267	662	12	102.85
8103	026508162309	623	6	182.95
8113	026508162279	623	6	271.05
8116	026508162316	623	6	335.10
8119	026508162330	622	6	317.75
8124	026508026168	623	6	269.30
8126	026508162347	622	6	318.60
8137	026508185476	622	6	256.55
8138	026508199046	622	6	305.40
8210F05	026508235430	617	6	209.90
8210F12	026508266847	617	6	209.90
8210SMF05	026508258866	617	6	209.90
8210SMF12	026508266854	617	6	209.90
8215F03	026508235447	617	6	232.75
8215F05	026508235454	617	6	232.75
8215F12	026508266946	617	6	232.75
8215SMF12	026508266830	617	6	232.75
8220F05	026508235508	616	3	328.75
8225	026508162439	619	3	341.35
8225SMF15	026508238684	619	3	341.35
8226	026508155431	619	6	263.75
8227	026508162255	619	3	320.60
8228F05	026508235522	616	3	349.50
8228F12	026508266823	616	3	349.50
8229	026508162262	619	6	284.60
8230	026508172179	623	3	218.45
8242	026508185483	617	3	367.70
8244	026508185490	617	3	388.40
8248	026508181089	619	3	334.30
8248SMF12	026508267073	619	3	334.30
8270	026508154618	618	6	249.65
8276	026508167717	618	6	224.10
8277	026508199060	622	6	227.10
8278	026508167809	618	6	263.05
8278SM	026508238714	618	6	263.05
8278SMF12	026508267080	618	6	263.05
8279	026508167816	618	6	284.65
8279SM	026508238738	618	6	279.90
8279SMF12	026508267097	618	6	279.90
8280	026508154632	620	6	252.80
8285	026508161203	620	6	273.55
8287	026508162231	117	6	315.10
8289	026508162248	620	6	335.75
8290	026508154069	662	12	126.35
8290EP15	026508213360	662	12	121.45
8292	026508172186	662	12	131.90
8310	026508006412	644	3	636.50
8310AC16	026508167649	644	4	636.50
8310ACDF16	026508205969	644	4	668.20
8310DF16	026508205976	644	3	668.20
8310M128	026508236529	648	3	198.30
8310M16	026508236536	648	3	198.30
8310M35	026508236543	648	3	198.30
8310MR128	026508236550	648	6	159.55
8310R16	026508160329	645	3	532.60
8310RDF16	026508205983	645	3	559.15
8310S35	026508265123	644	3	636.50
8310SR128	026508265178	645	3	532.60
8310SR35	026508265192	645	3	532.60
8311	026508199077	644	3	636.50
8311AC12	026508199091	644	3	636.50
8312	026508152225	644	4	636.50
8312AC10	026508167656	645	4	636.50
8312M0125	026508236574	648	3	198.30
8312M05	026508236581	648	3	198.30
8312M10	026508236598	648	3	198.30
8312R10	026508160305	645	3	532.60
8312SR05	026508265260	645	3	532.60
8312SR125	026508265284	645	3	532.60
8315	026508199084	644	3	636.50
8315AC05	026508199107	645	3	636.50
8316	026508205990	644	3	636.50
8316AC	026508213223	645	3	636.50
8342	026508078266	653	1	694.15
8342EP15	026508213377	653	1	694.15

Model No.	UPC	Page Number	Case Qty.	List Price
8343	026508083130	651	1	712.90
8346	026508063347	654	4	492.80
8346EP15	026508213384	654	4	492.80
8349	026508015094	662	6	79.90
8349EP15	026508213391	662	6	79.90
8349EP15CBN	026508237045	662	6	116.35
8349EP17	026508228647	662	6	79.90
8349EP17CBN	026508237052	662	6	116.35
8360	026508086810	660	6	243.70
8370	026508013960	651	12	198.10
8370HD	026508228470	651	6	139.65
8371HD	026508228487	651	6	168.05
8372HD	026508228494	651	6	168.05
8373HD	026508228500	651	6	168.05
8374HD	026508228517	651	6	181.15
8375	026508040423	651	12	223.20
8375EP15	026508213407	657	12	223.20
8375HD	026508239803	651	6	168.05
8389EP15	026508213414	656	6	254.90
8400	026508015063	630	6	188.20
8413F03	026508234440	616	3	179.75
8413F05	026508234457	616	3	179.75
8413F12	026508266564	616	3	179.75
8414	026508137123	616	6	214.50
8414F12	026508269954	616	3	214.50
8414F12BN	026508271773	616	3	268.15
8416	026508017272	616	6	193.05
8416F05	026508234471	616	3	193.05
8417F05	026508234495	615	6	248.30
8417F12	026508266571	615	6	248.30
8419F05	026508227848	615	6	282.05
8419F12	026508266588	615	6	282.05
8420	026508015070	630	12	218.40
8422	026508232125	491	12	197.45
8422F05	026508232149	630	12	197.45
8425	026508015087	630	12	212.65
8430	026508066454	630	12	147.15
8430CBN	026508235348	630	12	183.95
8430F05	026508232156	630	12	147.15
8432	026508066461	630	12	181.10
8432F05	026508264706	630	12	181.10
8434	026508066478	631	12	174.60
8437	026508232163	631	12	190.55
8437CBN	026508235355	631	12	238.20
8439	026508232170	631	12	156.65
8439F05	026508232675	631	12	156.65
8551	026508249901	639	6	644.95
8551AC	026508249918	642	6	663.95
8552	026508249925	639	6	719.95
8552AC	026508249932	642	6	719.95
8553	026508249949	639	6	644.95
8553AC	026508249956	642	6	663.95
8553ACBL	026508344590	640	6	896.35
8553ACBN	026508344606	640	6	829.95
8553BL	026508343715	639	6	870.70
8553BN	026508343722	639	6	806.20
8554	026508249963	640	6	719.95
8554AC	026508249970	642	6	719.95
8554ACBL	026508344613	642	6	971.95
8554ACBN	026508344620	642	6	899.95
8554BL	026508343739	640	6	971.95
8554BN	026508343746	640	6	899.95
8558	026508271995	636	3	523.45
8558BL	026508343753	636	3	706.65
8558BN	026508343760	636	3	654.30
8559	026508271483	636	6	615.25
8559BL	026508341599	636	6	830.60
8559BN	026508343777	636	6	769.05
8560	026508272008	636	3	523.45
8560BL	026508343784	636	1	706.65
8560BN	026508343791	636	3	654.30
8562	026508271490	637	3	1117.10
8565	026508271506	637	3	639.80
8701	026508129739	621	12	155.20
8707	026508206515	621	6	184.90
8713	026508020951	621	6	465.70
8717	026508237649	621	6	274.05
8780	026508021859	633	6	125.75
8792	026508125717	633	6	287.00
8798	026508003930	633	6	201.55

Model No.	UPC	Page Number	Case Qty.	List Price	Model No.	UPC	Page Number	Case Qty.	List Price
8799	026508013779	633	6	262.70	104553	026508245422	649	20	67.95
8800	026508007778	632	6	174.65	104554	026508245439	649	20	73.25
8800F05	026508235317	632	6	174.65	104555	026508246535	646	20	128.35
8810	026508007785	632	6	200.25	104556	026508244074	646	20	128.35
8820	026508007792	632	6	206.30	104557	026508244081	649	20	22.45
8884	026508093238	627	6	189.05	104560	026508247891	649	12	49.85
8886	026508093245	203	6	348.45	104561	026508246559	649	20	70.35
8889	026508093252	627	6	446.00	104563	026508245446	649	20	94.60
8894	026508220672	627	6	214.65	104564	026508246573	649	20	94.60
8915	026508094143	632	12	128.40	104565	026508245453	649	20	94.60
8917	026508030325	632	12	151.35	104566	026508245460	649	20	94.60
8922	026508039175	485	6	270.65	104567	026508245477	649	20	94.60
8924	026508039205	529	6	289.60	104568	026508245484	649	20	94.60
8938	026508003954	634	6	174.15	104569	026508245491	649	20	28.45
8948	026508061695	529	6	171.80	104570	026508245507	646	12	21.00
8957	026508030264	445	12	134.15	104571	026508246580	646	20	28.05
9263EP15	026508255438	662	12	77.05	104572	026508245514	649	20	7.30
9417F05	026508257296	615	3	274.75	104573	026508246801	649	20	27.15
9417F12	026508266977	615	3	274.75	104574	026508246818	649	15	59.30
9419F05	026508255483	615	3	305.30	104575	026508248010	649	6	53.20
9419F12	026508266984	615	3	305.30	104577	026508246825	649	30	12.75
9480	026508255490	629	3	170.05	104578	026508244098	646	12	53.60
9482	026508255506	629	3	188.95	104579	026508244104	646	12	58.15
15856	026508015186	663	12	63.60	104580	026508244111	646	12	53.70
15856CBN	026508239858	663	12	92.60	104581	026508244128	646	20	37.50
52016F05	026508236284	642	100	20.75	104582	026508246832	646	20	34.15
52016F10	026508228708	642	24	20.75	104583	026508246856	646	20	29.40
52100	026508207635	627	24	94.60	104584	026508247877	646	12	87.35
52120	026508207048	617	12	175.60	104585	026508247884	646	1	137.60
52124GBM25	0265082234112	660	3	251.45	104587	026508248614	646	6	167.70
52224GBM15	026508226964	661	3	257.20	104588	026508246863	646	20	31.55
52224GBM15CBN	026508236970	661	3	527.15	104589	026508246870	646	20	50.75
52224GBM17	026508226971	661	3	257.20	104590	026508247426	649	33	30.15
52224GBM25	026508226995	661	3	257.20	104591	026508247433	649	33	30.15
52224GBP25	026508227008	661	3	223.00	104592	026508247440	649	33	30.15
52236GBM15	026508227015	661	3	280.05	104593	026508247457	649	33	30.15
52236GBM15CBN	026508237007	661	3	572.90	104594	026508247464	649	33	30.15
52236GBM17	026508227022	661	3	280.05	104595	026508247471	649	33	30.15
52236GBM25	026508227046	661	3	280.05	104597	026508246849	649	40	20.15
52703	026508026083	663	12	70.55	104598	026508251843	649	20	29.70
52710	026508063361	661	6	291.90	104599	026508251850	649	20	53.35
52710CBN	026508237106	661	6	580.95	104600	026508252536	649	12	57.25
52710EP15	026508213346	661	6	291.90	104609	026508251867	649	20	11.65
52710EP15CBN	026508237144	661	6	580.95	104617	026508273999	646	12	34.00
52711	026508228630	663	12	52.90	104618	026508274002	646	12	80.40
52714	026508249871	663	12	52.90	104619	026508274019	646	12	80.40
52716EP15	026508213353	662	20	74.20	104620	026508274026	646	12	80.40
52740EP17	026508228524	661	6	291.30	104621	026508274033	646	12	80.40
52748EP15	026508234754	661	6	212.95	104622	026508274040	646	12	80.40
99550	026508207659	627	12	33.95	104623	026508274057	646	12	80.40
99551	026508220689	627	12	33.95	104624	026508274064	646	12	80.40
99556	026508252130	639	20	37.15	104625	026508274071	646	12	37.85
99557	026508252147	639	20	37.15	104626	026508274088	646	12	38.90
99557BL	026508343968	639	20	51.05	104627	026508274095	646	12	36.20
99557BN	026508343975	639	20	46.45	104628	026508274101	646	12	107.00
99558	026508252154	636	20	47.70	104630	026508273609	636	12	109.90
99558BL	026508343708	636	20	65.60	104631	026508274118	646	12	36.30
99558BN	026508343869	636	20	59.65	104633	026508274125	646	12	129.45
99559	026508258859	615	20	37.15	104634	026508274132	646	20	25.60
100686	026508057711	663	60	53.05	123816	026508140444	553	12	60.80
100686CBN	026508246436	663	60	76.25	123816BL	026508356722	553	12	94.00
104414	026508081525	663	1	57.30	123816BN	026508166994	553	12	85.15
104451	026508199282	640	12	180.55	174055	026508235799	642	12	34.05
104463	026508324257	464	12	180.55	174056	026508235904	642	12	108.15
104464	026508324240	464	12	180.55	174057	026508235911	642	12	30.05
104465	026508204368	464	12	180.55	174060	026508235942	642	12	19.05
104466	026508267103	464	12	180.55	174061	026508235959	642	12	26.70
104540	026508245293	649	20	42.65	174061BL	026508346426	642	12	36.75
104541	026508245309	649	20	37.35	174061BN	026508346433	642	12	33.40
104542	026508245316	649	20	51.95	174062	026508252765	642	12	9.85
104543	026508245323	649	20	57.30	174065	026508252772	642	12	54.00
104544	026508245330	649	20	63.95	174066	026508252789	642	12	6.25
104545	026508245347	649	20	70.60	174335	026508254394	642	12	213.65
104546	026508245354	649	20	37.35	174336	026508254400	642	20	21.20
104547	026508245361	649	20	41.35	174337	026508254417	642	20	21.20
104548	026508245378	649	20	44.00	174337BL	026508343845	642	20	29.15
104549	026508245385	649	20	47.95	174337BN	026508343852	642	20	26.50
104550	026508245392	649	20	53.35	175916	026508261903	641	12	17.05
104551	026508245408	649	20	57.30	175917	026508261910	641	1	17.05
104552	026508245415	649	20	63.95	175918	026508261927	641	12	17.05

Model No.	UPC	Page Number	Case Qty.	List Price
175921	026508266755	641	12	17.05
175925	026508266762	641	12	17.05
175926	026508266779	641	12	17.05
181040	026508266786	641	12	17.05
181148	026508274491	636	12	79.80
181148BL	026508343913	636	12	107.75
181148BN	026508343920	636	12	99.75
181149	026508274507	636	12	69.05
181149BL	026508343937	636	12	93.20
181149BN	026508343944	636	12	86.30
182413	026508272305	642	64	62.00
182414	026508272312	642	12	17.50
182415	026508272329	642	24	127.85
182416	026508272336	642	12	105.80
182417	026508272343	642	12	52.15
182418	026508272350	642	12	36.40
182419	026508272367	642	12	17.65
182420	026508272374	642	12	46.35
182421	026508272381	642	12	67.20
182422	026508272398	642	12	165.35
182534	026508273708	642	6	55.80
182535	026508273715	642	6	150.30
182536	026508273722	642	20	10.65
182537	026508273739	642	12	165.35
182538	026508273746	636	20	23.40
182540	026508273760	642	12	56.60
182542	026508273777	642	20	18.15
182543	026508273784	642	20	18.05
182544	026508273791	642	20	18.05
182546	026508273807	636	12	36.35
182546BL	026508343692	636	12	50.00
182546BN	026508343951	636	12	45.45
182547	026508273814	642	20	26.25
A705	026508240816	436	12	56.05
A705CBN	026508240823	436	12	84.05
A723	026508228654	663	20	32.65
A725	026508044551	439	12	66.10
A725CBN	026508191224	663	12	86.85
A726	026508073032	119	12	134.25
A780	026508227138	118	20	158.35
CA8301	026508211076	642	3	623.50
CA8301BL	026508343807	636	3	841.75
CA8301BN	026508343814	636	3	779.40
CA8302	026508211083	642	6	615.25
CA8302BL	026508343821	636	6	830.60
CA8302BN	026508343838	636	6	769.05
CA8303	026508211090	642	3	693.80
S0000	026508181461	624	12	55.35
S0001	026508025314	624	12	66.55
S0002	026508025321	624	12	67.95
S0003	026508025338	624	12	66.55
S0004	026508025345	624	12	79.95
S0007	026508025376	624	12	67.95
S0009	026508025390	624	12	73.25
S0010	026508025406	624	12	79.95
S0011	026508025413	624	12	66.55
S0012	026508025420	624	12	145.30
S0030NA	026508273821	625	6	76.90
SMA1000CH	034584007728	531	24	39.35
SV003	026508025444	624	12	137.25
SV006	026508025475	624	12	127.95
SV010	026508025512	624	12	134.60
T4192	026508260326	551	12	151.75
T8342	026508228562	653	1	361.00
T8342CBN	026508237151	653	1	530.65
T8342EP15	026508228579	653	1	361.00
T8342EP15CBN	026508237168	653	1	530.65
T8342NH	026508237175	653	1	352.35
T8342NHCBN	026508237182	653	1	483.15
T8343	026508228586	651	1	381.40
T8343CBN	026508237199	651	1	560.80
T8343EP15	026508228593	651	1	381.40
T8343EP15CBN	026508237625	651	1	560.80
T8346	026508228609	655	4	333.15
T8346CBN	026508235638	655	4	472.40
T8346EP15	026508228616	655	4	333.15
T8346EP15CBN	026508235645	655	4	472.40
T8360	026508222775	660	3	48.15
T8360CBN	026508235652	660	3	87.95
T8370	026508211885	658	3	37.65

Model No.	UPC	Page Number	Case Qty.	List Price
T8370CBN	026508235669	658	3	68.75
T8375	026508211892	657	3	65.05
T8375EP15	026508222782	657	3	65.05
T8375NH	026508235690	657	3	46.10
T8375NHCBN	026508235706	657	3	77.05
T8389	026508212134	656	3	99.60
T8389EP15	026508222799	656	3	99.60
T8389EP15CBN	026508235720	656	3	155.60
T9342EP15	026508257340	652	1	493.55
T9342GBM15	026508257388	652	1	542.85
T9346GBM15	026508255568	654	1	478.25
T9360	026508255582	660	3	133.20
T9370	026508255599	658	3	104.10
T9375EP15	026508255612	657	3	130.25
T9389EP15	026508255636	656	3	165.70
U8350	026508319697	659	3	255.30
UT8350	026508321126	659	3	189.70
UT8350CBN	026508321133	659	3	243.45

PRICE BAND IDENTIFICATION

Kitchen Collections

PREMIUM / BEST
IMAP PROTECTED

Nio – Modern
STö – Modern
Weymouth – Traditional
Sinema – Transitional
Paterson – Traditional

2ND UPGRADE / BETTER
IMAP PROTECTED

Cia – Modern
Align – Modern
KURV – Transitional

1ST UPGRADE / GOOD
IMAP PROTECTED

Belfield – Traditional
Genta LX – Modern
Sleek – Modern

1ST UPGRADE / GOOD
NOT IMAP PROTECTED

Brantford – Traditional
Arbor – Transitional
Camerist – Transitional
Method – Modern
Core Soap Dispensers

SPEC
NOT IMAP PROTECTED

Integra – Transitional
Chateau – Transitional
Banbury – Transitional

PREMIUM / BEST
IMAP PROTECTED

Kitchen Compliments
– Pot Fillers
– SIP Carbon Filtration Compatible Faucets
– Premium Soap Dispensers

1ST UPGRADE / GOOD
IMAP PROTECTED

**SIP Reverse Osmosis &
Carbon Compatible Faucets**

Kitchen Sinks and Disposals

IMAP PROTECTED

Kitchen Sinks
Fireclay
Granite
Stainless Steel
– 1800 Professional Workstation Series
– 1600 Professional Series
– 1800 Professional Series

Disposals
The Chef Series
The Host Series
The Prep Series
The Lite Series

Touchless Kitchen Collections

PREMIUM / BEST
IMAP PROTECTED

Touchless Smart Faucet with Motion Control
Nio – Modern
Weymouth – Traditional
Sinema – Transitional
Paterson – Traditional

Smart Faucet
Nio – Modern
STö – Modern
Weymouth – Traditional
Sinema – Transitional
Paterson – Traditional

MotionSense Wave
Weymouth – Traditional
Sinema – Transitional

2ND UPGRADE / BETTER
IMAP PROTECTED

Smart Faucet
Cia – Modern
Align – Modern
KURV – Transitional

MotionSense Wave
Cia – Modern
Align – Modern
KURV – Transitional

1ST UPGRADE / GOOD
IMAP PROTECTED

Smart Faucet
Brantford – Traditional
Arbor – Transitional
Belfield – Traditional
Sleek – Modern

MotionSense Wave
Brantford – Traditional
Arbor – Transitional
Belfield – Traditional
Genta LX – Modern
Sleek – Modern

Smart Water Network

PREMIUM / BEST
IMAP PROTECTED

Flo Smart Water Monitor and Shutoff
Smart Leak Detector
Smart Sump Pump Monitor
Smart Irrigation
– Smart Sprinkler Controller - 8 Zone
– Smart Sprinkler Controller - 16 Zone
– Smart Wireless Soil Sensor
– Smart Sprinkler Controller Outdoor Enclosure

Bath and Shower Collections

PREMIUM / BEST
IMAP PROTECTED

Weymouth – Traditional
Arris – Modern
Flara – Transitional
Colinet – Traditional
90 – Modern
Via – Modern
Doux – Modern
Smart Shower
**Premium Showerheads, Handshowers
and Shower Rails**
Annex and Moen Spa Shower Rail

2ND UPGRADE / BETTER
IMAP PROTECTED

Greenfield – Transitional
Wynford – Traditional
Align – Modern
Rizon – Modern
Belfield – Traditional
Cia – Modern
Voss – Transitional

MotionSense Wave
Flara – Transitional
Doux – Modern
Cia – Modern

1ST UPGRADE / GOOD
IMAP PROTECTED

Dartmoor – Traditional
Glyde – Transitional

1ST UPGRADE / GOOD
NOT IMAP PROTECTED

Brantford – Traditional
Eva – Transitional
Vichy – Transitional
Gibson – Modern
Genta LX – Modern

SPEC
NOT IMAP PROTECTED

Chateau – Transitional



Look for the WaterSense® logo to identify water-efficient Moen® faucets and showerheads that meet WaterSense® criteria.

Moen® kitchen faucet SKUs* are manufactured with a 1.5 gpm aerator that is certified to meet WaterSense® criteria. As of July 1, 2016, lavatory faucets are manufactured with a 1.2 gpm aerator that is certified to meet WaterSense® criteria and the California Energy Commission (CEC) regulation. The packaging label clearly indicates the WaterSense® logo and product flow rate. If the product you receive does not have the qualifying label markings, a replacement aerator can be ordered by calling 1-800-BUY-MOEN.

Moen® flow-optimized rainshowers and showerheads use up to 30% less water (compared to traditional 2.5 gpm showerheads) without sacrificing performance. Products throughout our showering portfolio with a WaterSense logo — including wall-mount, handshower and rainshower showerheads - are certified to meet EPA WaterSense® labeling criteria. These also contribute towards maximizing LEED points.

*Excluding all bathtub spouts and some commercial faucets and showerheads.



Moen® Eco-Performance (EP) showerheads and handshowers are flow-optimized to use up to 30% less water (compared to traditional 2.5 gpm showerheads) without sacrificing performance, and contribute towards maximizing LEED points.



The U.S. Green Building Council® developed the Leadership in Energy and Environmental Design (LEED®) Green Building Rating System as a nationally accepted benchmark for measuring and documenting green building practices.



The Green UPC® symbol indicates that this product has been certified by the International Association of Plumbing and Mechanical Officials (IAPMO) to reduce water consumption by at least 20% when compared to standard flow rates.

All Moen® lavatory and kitchen faucets meet NSF 372 requirements.



ADA Compliant – Many Moen® faucets, sinks and shower valve controls meet requirements for the physically challenged.

Shower Valve Rates

FLOW RATE VS. FLOWING INLET PRESSURE OF MOEN® SHOWERING VALVES (UNRESTRICTED)

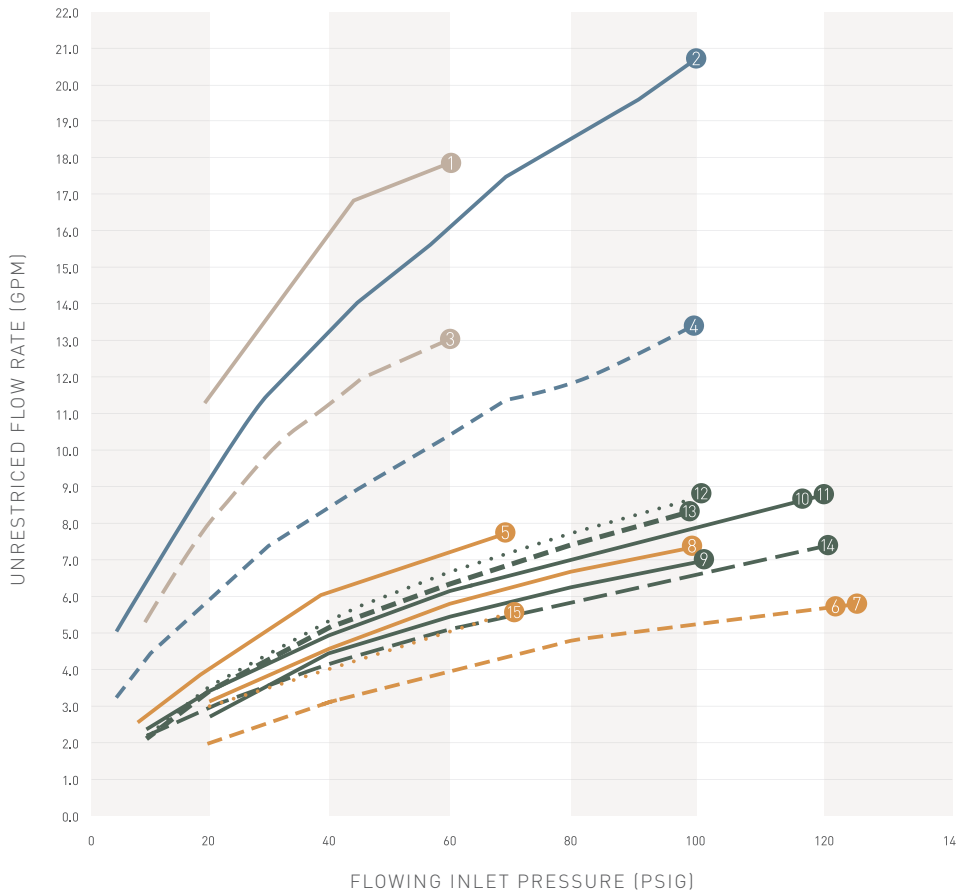

- 1 **ExactTemp[®] 3/4" Thermostatic Showering**
S3371 3/4" ExactTemp: 18.0 GPM
- 2 **Smart Shower—4-Outlet**
S3104 4-Outlet: 16.0 GPM
- 3 **Volume Control**
S3600 Volume Control: 13+ GPM
- 4 **Smart Shower—2-Outlet**
S3102 2-Outlet: 10.0 GPM
- 5 **Posi-Temp[®] Tub Port**
4-Port Valve
Flow at Tub: 6.3 GPM
- 6 **Posi-Temp Shower Port**
4-Port Valve
Flow at Shower: 4.0 GPM
- 7 **Posi-Temp Shower Port**
3-Port Valve
Flow at Tub: 6.3 GPM
- 8 **M-CORE[™] 4-Series Tub Port**
Flow at Tub: 5.7 GPM
- 9 **M-CORE 4-Series Shower Port**
Flow at Shower: 5.3 GPM
- 10 **M-CORE 3-Series Tub Port**
Flow at Tub: 6.2 GPM
- 11 **M-CORE 3-Series Shower Port**
Flow at Shower: 5.8 GPM
- 12 **M-CORE 2-Series Tub Port**
Flow at Tub: 6.7 GPM
- 13 **M-CORE 2-Series Shower Port**
Flow at Shower: 6.4 GPM
- 14 **M-CORE with Transfer**
Two Outlets: 5.6 GPM
- 15 **Posi-Temp with Integrated Transfer**
Two Outlets: 5.0 GPM

SHOWER SPA INSTALLATION RECOMMENDATIONS

Graph Line	Valves	Flow Rate through Shower Port (GPM) at 20 PSI	Flow Rate through Shower Port (GPM) at 40 PSI	Flow Rate through Shower Port (GPM) at 60 PSI	Use with a Transfer Valve	Maximum Components
1	ExactTemp 3/4" Thermostatic S3371	11.4	15.7	18.0	No	4 Components: Any Combination of Showerheads, Handshowers and Body Sprays (4 max)
2	Smart Shower—4-Outlet S3104	9.0	13.0	16.0	No	4 Components: Any Combination of Showerheads, Handshowers and Body Sprays (4 max)
4	Smart Shower—2-Outlet S3102	6.0	8.5	10.0	No	Showerhead, Handshower or Showerhead, 2 Body Sprays
6	Posi-Temp 3-Port	3.6	5.1	6.3	Yes	Showerhead, Handshower or Showerhead, 2 Body Sprays*
7	M-CORE 4-Series Shower Port	2.9	4.3	5.3	Yes	Showerhead, Handshower or Showerhead, 2 Body Sprays*
9	M-CORE 3-Series Shower Port	3.1	4.6	5.8	Yes	Showerhead, Handshower or Showerhead, 2 Body Sprays*
11	M-CORE 2-Series Shower Port	3.5	5.1	6.4	Yes	Showerhead, Handshower or Showerhead, 2 Body Sprays*
13	M-CORE with Transfer	3.0	4.5	5.6	No	Showerhead, Handshower or Showerhead, 2 Body Sprays*
14	Posi-Temp Shower Port 4-Port	2.1	3.2	4.0	Yes	Showerhead, Handshower*
15	Posi-Temp with Integrated Transfer	3.0	4.0	5.0	No	Showerhead, Handshower

*Minimum 50 PSI recommended when plumbing a showerhead and 2 body sprays for shared flow.



Customer Service

Moen, Commercial, CFG and Garbage Disposal

MOEN FAUCET PRODUCTS

Phone: 1-800-531-1600

Fax: 1-800-848-6636

Email orders and general inquiries to:

moencustomerservicewholesaleUS@moen.com

MOEN B2B CONNECT

Moen's best-in-class sales support

Phone: 1-800-531-1600

Email: moencustomerservicewholesaleUS@moen.com

Website: B2BConnect.com

MOEN ACCESSORY PRODUCTS

Phone: 1-800-882-0116

Fax: 1-888-379-2720

Email orders and general inquiries to:

moencustomerserviceUS@moen.com

HELPFUL WEBSITES

moen.com

CFGonline.com

moen.com/professional

Pricing effective January 1, 2023. Although descriptions are believed correct at publication approval, accuracy cannot be guaranteed.

Moen reserves the right to make product specification changes from time to time, without notice or obligation, and to change or discontinue models.

Connect with us:
moen.com/social

U.S. Headquarters:
Moen Incorporated
25300 Al Moen Drive
North Olmsted, OH 44070-8022

Canada Headquarters:
Moen
2816 Bristol Circle
Oakville, Ontario L6H 5S7

Visit our website at moen.com

1-800-BUY-MOEN

1-800-465-6130